

Microcontroller Supervisory Circuit with Push-Pull Output

FEATURES

- Holds microcontroller in reset until supply voltage reaches stable operating level
- Resets microcontroller during power loss
- Precision monitoring of 3V, 3.3V, and 5V systems
- 7 voltage trip points available
- Active low $\overline{\text{RESET}}$ pin (MCP100) or active high RESET (MCP101)
- Push-pull output
- Holds $\overline{\text{RESET}}$ /RESET for 350 ms (typical)
- Guaranteed $\overline{\text{RESET}}$ /RESET to $V_{DD} = 1.0V$
- Accuracy of $\pm 125mV$ for 5V systems and $\pm 75mV$ for 3V systems over temperature
- 45 μA typical operating current
- Temperature range:
 - Industrial (I): $-40^{\circ}C$ to $+85^{\circ}C$

DESCRIPTION

The Microchip Technology Inc. MCP100/101 is a voltage supervisory device designed to keep a microcontroller in reset until the system voltage has reached the proper level and stabilized. It also operates as protection from brown-out conditions when the supply voltage drops below a safe operating level. Both devices are available with a choice of seven different trip voltages and both have push-pull outputs. The MCP100 has a low active $\overline{\text{RESET}}$ pin and the MCP101 has a high active RESET pin. The MCP100/101 will assert the $\overline{\text{RESET}}$ /RESET signal whenever the voltage on the V_{DD} pin is below the trip-point voltage.

PACKAGES

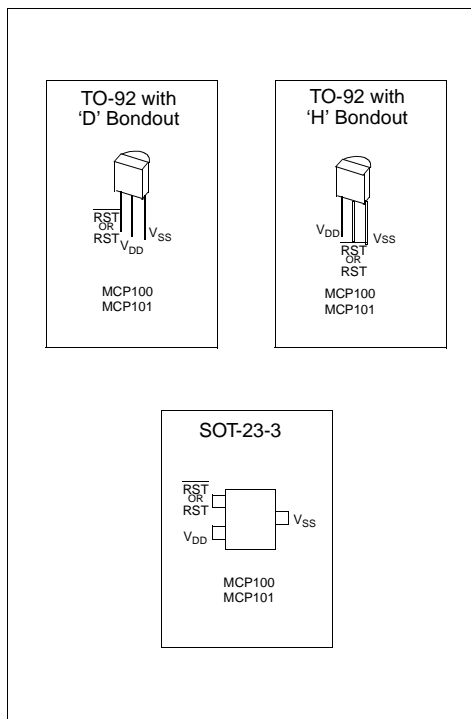

BLOCK DIAGRAM

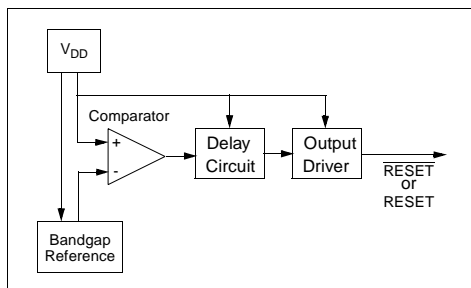

MCP100/101

1.0 ELECTRICAL CHARACTERISTICS

1.1 Maximum Ratings*

| | |
|---|--------------------------------|
| V _{DD} | 7.0V |
| All inputs and outputs w.r.t. V _{SS} | -0.6V to V _{DD} +1.0V |
| Storage temperature | -65°C to +150°C |
| Ambient temp. with power applied | -65°C to +125°C |
| Soldering temperature of leads (10 seconds) | +300°C |
| ESD protection on all pins | ≥ 2 kV |

***Notice:** Stresses above those listed under “Maximum Ratings” may cause permanent damage to the device. This is a stress rating only and functional operation of the device at those or any other conditions above those indicated in the operational listings of this specification is not implied. Exposure to maximum rating conditions for extended periods may affect device reliability.

DC AND AC CHARACTERISTICS

| All parameters apply at the specified temp and voltage ranges unless otherwise noted. | | V _{DD} = 1.0 - 5.5V Industrial (I): -40°C to +85°C | | | | |
|---|--|--|----------------------|------|-------|---|
| PARAMETER | SYMBOL | MIN | TYP | MAX | UNITS | TEST CONDITIONS |
| Operating Voltage Range | V _{DD} | 1.0 | | 5.5 | V | |
| V _{DD} Value to Guarantee RESET/ RESET | V _{DDMIN} | 1.0 | | | V | |
| Operating current | I _{DD} | | 45 | 60 | µA | V _{DD} = 5.5V (no load) |
| V _{DD} Trip Point | MCP10X-270 | 2.55 | 2.625 | 2.7 | V | |
| | MCP10X-300 | 2.85 | 2.925 | 3.0 | | |
| | MCP10X-315 | 3.0 | 3.075 | 3.15 | | |
| | MCP10X-450 | 4.25 | 4.375 | 4.50 | | |
| | MCP10X-460 | 4.35 | 4.475 | 4.60 | | |
| | MCP10X-475 | 4.50 | 4.625 | 4.75 | | |
| | MCP10X-485 | 4.60 | 4.725 | 4.85 | | |
| RESET Low Level Output Voltage (MCP100) | MCP100-270 MCP100-300 MCP100-315 | | | 0.4 | V | I _{OL} = 3.2mA, V _{DD} = V _{TRIPMIN} |
| | MCP100-450 MCP100-460 MCP100-475 MCP100-485 | | | 0.6 | | |
| RESET High Level Output Voltage (MCP100) | MCP100-XXX (All V _{TRIP} Points) | V _{OH} | V _{DD} -0.7 | | V | I _{OH} = 3mA, V _{DD} > V _{TRIPMAX} |
| RESET Low Level Output Voltage (MCP101) | MCP101-270 MCP101-300 MCP101-315 | | | 0.4 | V | I _{OL} = 3.2mA, V _{DD} > V _{TRIPMAX} |
| | MCP101-450 MCP101-460 MCP101-475 MCP101-485 | | | 0.6 | | |
| RESET High level Output Voltage (MCP101) | MCP101-XXX (All V _{TRIP} Points) | V _{OH} | V _{DD} -0.7 | | V | I _{OH} = 3mA, V _{DD} = V _{TRIPMIN} |
| Threshold Hysteresis | V _{HYS} | | 50 | | mV | |
| V _{DD} Detect to RESET/RESET Inactive | t _{RPU} | 150 | 350 | 700 | ms | |
| V _{DD} Detect to RESET/RESET | t _{RPD} | | 10 | | µs | V _{DD} ramped from V _{TRIPMAX} + 250mV down to V _{TRIPMIN} - 250mV |

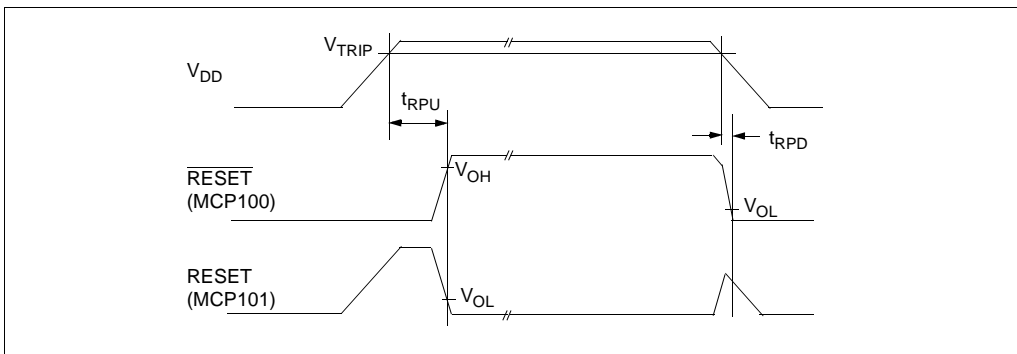

FIGURE 1-1: MCP100/101 Timing Diagram

2.0 APPLICATIONS INFORMATION

2.1 The Need for Supervisory Circuits

For many of today's microcontroller applications, care must be taken to prevent low power conditions that can cause many different system problems. The most common causes are brown-out conditions where the system supply drops below the operating level momentarily, and the second, is when a slowly decaying power supply causes the microcontroller to begin executing instructions without enough voltage to sustain SRAM and producing indeterminate results.

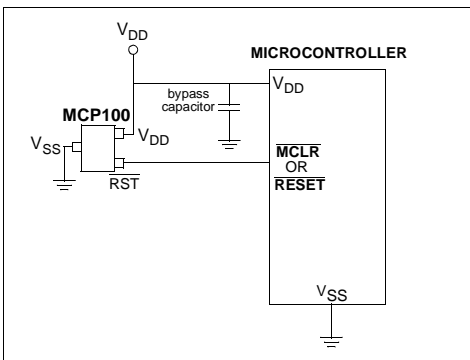

FIGURE 2-1: Typical Application

2.2 Negative Going V_{DD} Transients

Many system designers implementing POR circuits are concerned about the minimum pulse width required to cause a reset. Figure 2-2 shows typical transient duration vs. reset comparator overdrive for which the MCP100/101 will not generate a reset pulse. It shows that the farther below the trip point the transient pulse goes, the duration of the pulse required to cause a reset gets shorter. A 0.1 μ F bypass cap mounted as close as possible to the V_{DD} pin provides additional transient immunity.

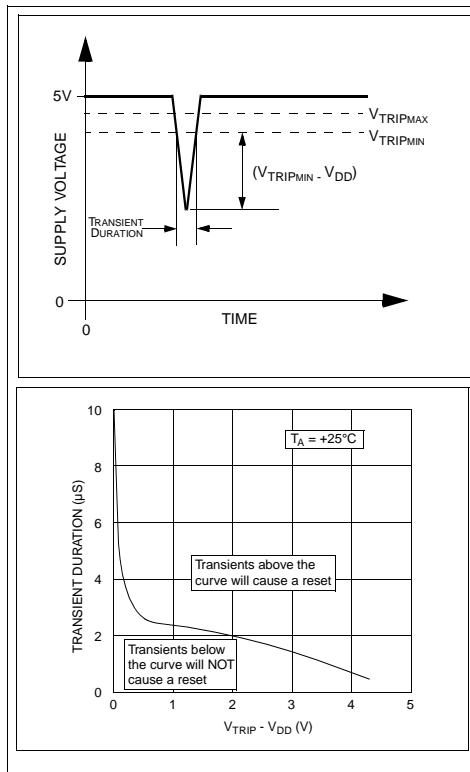

FIGURE 2-2: Typical Transient Response

2.3 Effect of Temperature on Timeout Period (t_{RPU})

The timeout period (t_{RPU}) determines how long the device remains in the reset condition. This is controlled by an internal RC timer and is effected by both V_{DD} and temperature. The graph shown in Figure 2-3 shows typical response for different V_{DD} values and temperatures.

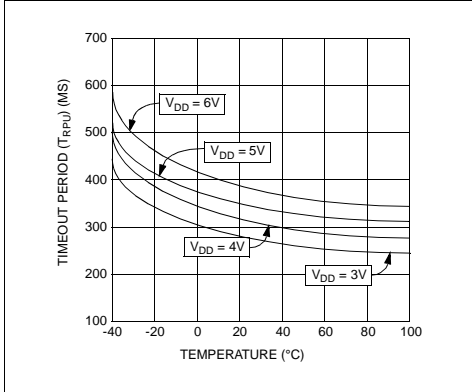

FIGURE 2-3: Typical t_{RPU} vs. Temperature

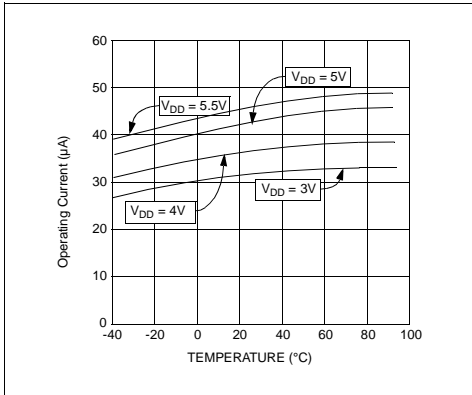

FIGURE 2-4: I_{DD} vs. Temperature

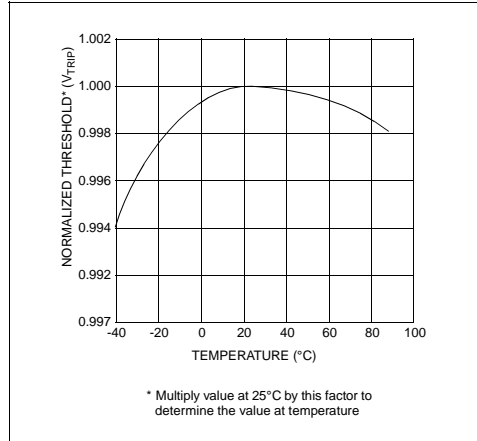

FIGURE 2-5: Normalized V_{TRIP} vs. Temperature

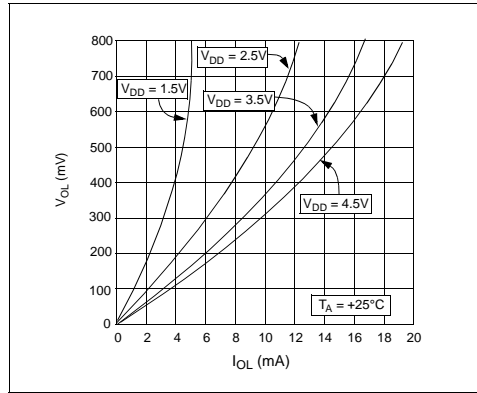

FIGURE 2-6: V_{OL} vs. I_{OL}

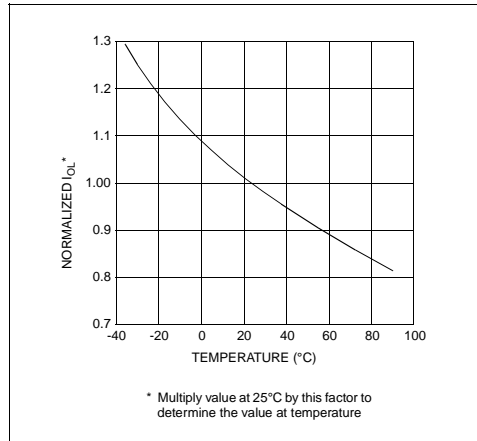

FIGURE 2-7: Normalized I_{OL} vs. Temperature

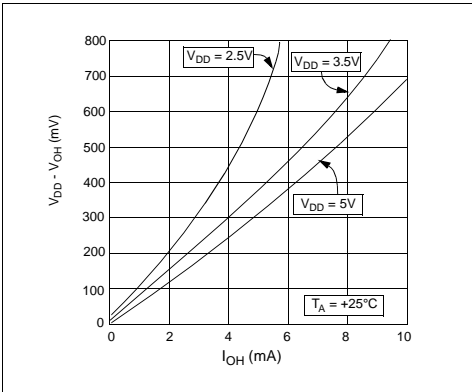

FIGURE 2-8: $V_{DD} - V_{OH}$ vs. I_{OH}

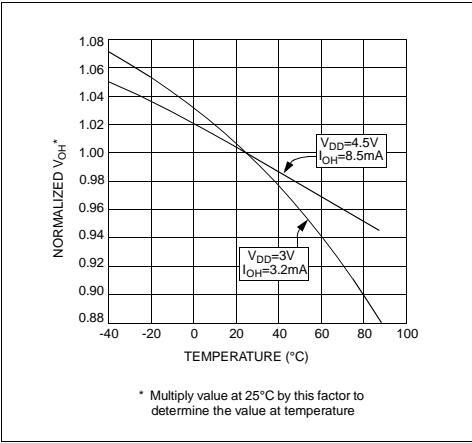
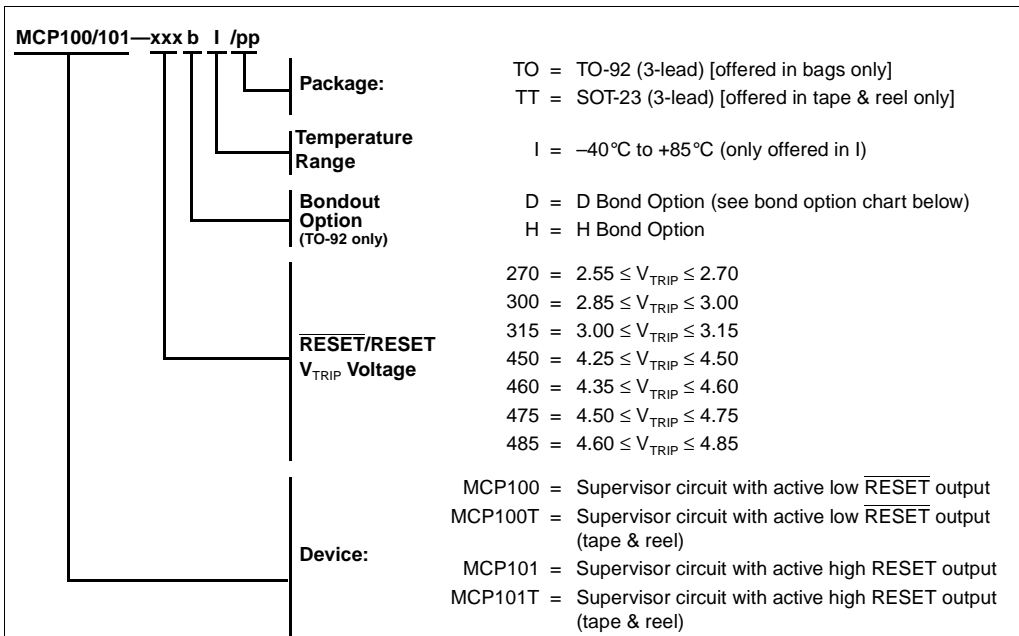

FIGURE 2-9: Normalized V_{OH} vs. Temperature

MCP100/101

NOTES:

MCP100/101 PRODUCT IDENTIFICATION SYSTEM



Product Identification Options for MCP100/101

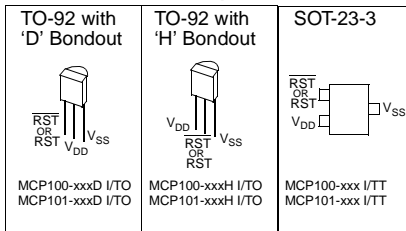

Example of Product Identification:

For the MCP100 (active low $\overline{\text{RESET}}$ pin) with V_{TRIP} range of 2.55V - 2.70V in T0-92 package with 'H' bond option in industrial temp range, the part number would be: MCP100-270H I/TO.

Sales and Support

Data Sheets

Products supported by a preliminary Data Sheet may have an errata sheet describing minor operational differences and recommended workarounds. To determine if an errata sheet exists for a particular device, please contact one of the following:

1. Your local Microchip sales office
2. The Microchip Corporate Literature Center U.S. FAX: (480) 786-7277.
3. The Microchip Worldwide Site (www.microchip.com)

Please specify which device, revision of silicon and Data Sheet (include Literature #) you are using.

New Customer Notification System

Register on our web site (www.microchip.com/cn) to receive the most current information on our products.



WORLDWIDE SALES AND SERVICE

AMERICAS

Corporate Office

Microchip Technology Inc.
2355 West Chandler Blvd.
Chandler, AZ 85224-6199
Tel: 602-786-7200 Fax: 602-786-7277
Technical Support: 602-786-7627
Web Address: <http://www.microchip.com>

After September 1, 1999:

Tel: 480-786-7200 Fax: 480-786-7277
Technical Support: 480-786-7627

Atlanta

Microchip Technology Inc.
500 Sugar Mill Road, Suite 200B
Atlanta, GA 30350
Tel: 770-640-0034 Fax: 770-640-0307

Boston

Microchip Technology Inc.
5 Mount Royal Avenue
Marlborough, MA 01752
Tel: 508-480-9990 Fax: 508-480-8575

Chicago

Microchip Technology Inc.
333 Pierce Road, Suite 180
Itasca, IL 60143
Tel: 630-285-0071 Fax: 630-285-0075

Dallas

Microchip Technology Inc.
4570 Westgrove Drive, Suite 160
Addison, TX 75248
Tel: 972-818-7423 Fax: 972-818-2924

Dayton

Microchip Technology Inc.
Two Prestige Place, Suite 150
Miamisburg, OH 45342
Tel: 937-291-1654 Fax: 937-291-9175

Detroit

Microchip Technology Inc.
Tri-Atria Office Building
32255 Northwestern Highway, Suite 190
Farmington Hills, MI 48334
Tel: 248-538-2250 Fax: 248-538-2260

Los Angeles

Microchip Technology Inc.
18201 Von Karman, Suite 1090
Irvine, CA 92612
Tel: 949-263-1888 Fax: 949-263-1338

New York

Microchip Technology Inc.
150 Motor Parkway, Suite 202
Hauppauge, NY 11788
Tel: 516-273-5305 Fax: 516-273-5335

San Jose

Microchip Technology Inc.
2107 North First Street, Suite 590
San Jose, CA 95131
Tel: 408-436-7950 Fax: 408-436-7955

AMERICAS (continued)

Toronto

Microchip Technology Inc.
5925 Airport Road, Suite 200
Mississauga, Ontario L4V 1W1, Canada
Tel: 905-405-6279 Fax: 905-405-6253

ASIA/PACIFIC

Hong Kong

Microchip Asia Pacific
Unit 2101, Tower 2
Metroplaza
223 Hing Fong Road
Kwai Fong, N.T., Hong Kong
Tel: 852-2-401-1200 Fax: 852-2-401-3431

Beijing

Microchip Technology, Beijing
Unit 915, 6 Chaoyangmen Bei Dajie
Dong Erhuan Road, Dongcheng District
New China Hong Kong Manhattan Building
Beijing 100027 PRC
Tel: 86-10-85282100 Fax: 86-10-85282104

India

Microchip Technology Inc.
India Liaison Office
No. 6, Legacy, Convent Road
Bangalore 560 025, India
Tel: 91-80-229-0061 Fax: 91-80-229-0062

Japan

Microchip Technology Intl. Inc.
Benex S-1 6F
3-18-20, Shinyokohama
Kohoku-Ku, Yokohama-shi
Kanagawa 222-0033 Japan
Tel: 81-45-471-6166 Fax: 81-45-471-6122

Korea

Microchip Technology Korea
168-1, Youngbo Bldg. 3 Floor
Samsung-Dong, Kangnam-Ku
Seoul, Korea
Tel: 82-2-554-7200 Fax: 82-2-558-5934

Shanghai

Microchip Technology
RM 406 Shanghai Golden Bridge Bldg.
2077 Yan'an Road West, Hong Qiao District
Shanghai, PRC 200335
Tel: 86-21-6275-5700 Fax: 86 21-6275-5060

ASIA/PACIFIC (continued)

Singapore

Microchip Technology Singapore Pte Ltd.
200 Middle Road
#07-02 Prime Centre
Singapore 188980
Tel: 65-334-8870 Fax: 65-334-8850

Taiwan, R.O.C

Microchip Technology Taiwan
10F-1C 207
Tung Hua North Road
Taipei, Taiwan, ROC
Tel: 886-2-2717-7175 Fax: 886-2-2545-0139

EUROPE

United Kingdom

Arizona Microchip Technology Ltd.
505 Eskdale Road
Winnersh Triangle
Wokingham
Berkshire, England RG41 5TU
Tel: 44 118 921 5858 Fax: 44-118 921-5835

Denmark

Microchip Technology Denmark ApS
Regus Business Centre
Lautrup hof 1-3
Ballerup DK-2750 Denmark
Tel: 45 4420 9895 Fax: 45 4420 9910

France

Arizona Microchip Technology SARL
Parc d'Activite du Moulin de Massy
43 Rue du Saule Trapu
Batiment A - 1er Etage
91300 Massy, France
Tel: 33-1-69-53-63-20 Fax: 33-1-69-30-90-79

Germany

Arizona Microchip Technology GmbH
Gustav-Heinemann-Ring 125
D-81739 München, Germany
Tel: 49-89-627-144 0 Fax: 49-89-627-144-44

Italy

Arizona Microchip Technology SRL
Centro Direzionale Colleoni
Palazzo Taurus 1 V. Le Colleoni 1
20041 Agrate Brianza
Milan, Italy
Tel: 39-39-65791-1 Fax: 39-39-6899883

08/11/99



Microchip received ISO 9001 Quality System certification for its worldwide headquarters, design, and wafer fabrication facilities in January 1997. Our field-programmable PICmicro[®] 8-bit MCUs, KEELoc[®] code hopping devices, Serial EEPROMs, related specialty memory products and development systems conform to the stringent quality standards of the International Standard Organization (ISO).

All rights reserved. © 1999 Microchip Technology Incorporated. Printed in the USA. 9/99 Printed on recycled paper.

Information contained in this publication regarding device applications and the like is intended for suggestion only and may be superseded by updates. No representation or warranty is given and no liability is assumed by Microchip Technology Incorporated with respect to the accuracy or use of such information, or infringement of patents or other intellectual property rights arising from such use or otherwise. Use of Microchip's products as critical components in life support systems is not authorized except with express written approval by Microchip. No licenses are conveyed, implicitly or otherwise, under any intellectual property rights. The Microchip logo and name are registered trademarks of Microchip Technology Inc. in the U.S.A. and other countries. All rights reserved. All other trademarks mentioned herein are the property of their respective companies.