



SI® brand inserts employ press-in, molded-in, or heat/ultrasonic installation methods to provide strong, reusable, permanent threads in plastic.



SI®

## THREADED INSERTS FOR PLASTICS

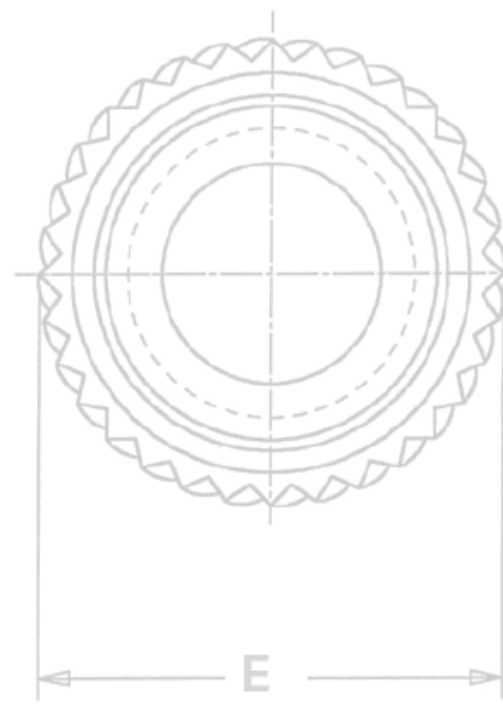
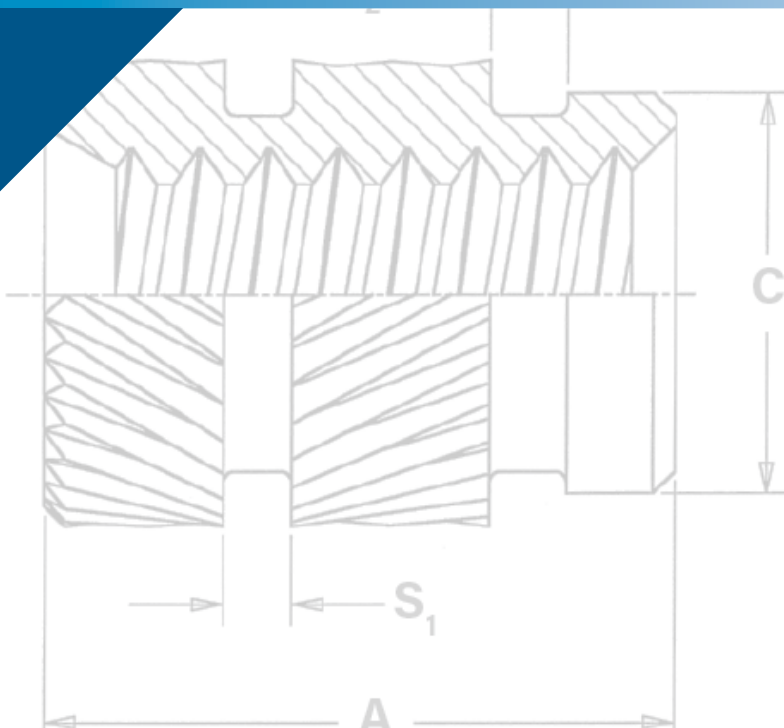

## SI® brand inserts employ press-in, molded-in, or heat/ultrasonic installation methods to provide strong, reusable, permanent threads in plastic.

- SI® inserts are typically specified in applications where strong, durable metal threads are required in plastic material, especially where frequent assembly and disassembly of the unit for service or repair is necessary.
- Applications for SI® products include: electronics (including wearables, smart phones and hand held devices), automotive, aerospace and defense, medical, transportation, industrial and recreational equipment.
- SI® inserts are available in brass, stainless steel and aluminum.
- SI® inserts are available in a large variety of ultrasonic / heat staking, molded-in or press-in types.
- Aluminum and stainless steel inserts for plastics offer lead-free alternatives to leaded brass typically used for brass inserts.
  - Lead-free inserts offer alternative to leaded brass to address environmental and end-of-life recycling concerns.
  - Aluminum inserts are approximately 70% lighter than brass equivalents and made from lead-free aluminum.
  - Stainless steel inserts are typically stronger than brass and may offer better protection from certain types of corrosive agents.
- **NEW compression limiters** for plastic assemblies.
- SI® microPEM® inserts provide threads as small as M1.



Lead-free, lightweight aluminum inserts.

### PART NUMBER DESIGNATION AND MATERIAL AND FINISH SPECIFICATIONS

**IU B - 440 - 2**

**Length Code (where applicable):**

See individual product charts for actual corresponding dimensional lengths.

**Thread Code:**

Internal, ASME B1.1, 2B / ASME B1.13M, 6H (except where noted). For PPB, PFLB, and PKB inserts collapsed slot and burrs may cause prevailing torque while thread accepts class 3A/4h screw. See individual product charts for actual corresponding thread size.

**Material Code:**

B = Free-machining, leaded brass. Plain finish. Meets RoHS requirements.  
 C = 300 series stainless steel. Passivated and/or tested per ASTM A380.  
 A = Aluminum. Plain finish.

**Type:**

IU = Ultrasonic/thermal, tapered  
 IUT = Ultrasonic/thermal, straight wall  
 IUTF = Flanged, ultrasonic/thermal, straight wall  
 IS = Ultrasonic/thermal, symmetrical  
 MSI = microPEM®, Ultrasonic/thermal, symmetrical  
 IB = Molded-in, blind threaded  
 IBL = Molded-in, self-locking blind threaded

IT = Molded-in, thru-threaded  
 STK = Molded-in, knurled  
 NFP = Press-in, hexagonal  
 PP = Press-in, thru-threaded  
 PFL = Press-in, flange-head  
 PK = Press-in, straight knurl

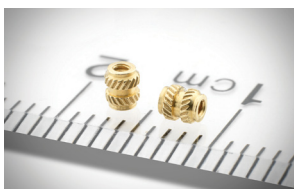

Featuring threads as small as M1.

**microPEM®**  
**FASTENERS**







Insert drawings and models are available at [www.pemnet.com](http://www.pemnet.com)

## SI® BRAND COMPRESSION LIMITERS

for plastic applications

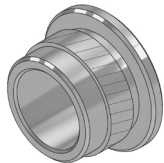
Compression limiters are non-threaded inserts that are commonly used in applications where a compressive load is applied to a plastic assembly. The compression limiter strengthens the plastic and withstands the compressive force that is applied when a mating screw is tightened in the assembly. The integrity of the plastic is not compromised by the load that is applied.

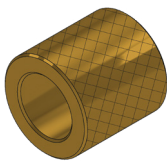
- Custom designed in a wide range of sizes and profiles
- Available in brass, stainless steel, and lead-free aluminum
- Installed using ultrasonic, heat-staking or molded-in installation methods
- Available design types; flange-head, symmetrical, full diamond knurl and non-knurled symmetrical

 <p><b>Flange-head</b> Larger contact area provides high resistance to axial loads and eliminates direct contact of plastic with mating components. Can be used for all installation methods.</p>	 <p><b>Symmetrical</b> Symmetrical design offers fast loading without the need to orientate the part. Can be used for all installation methods.</p>	 <p><b>Full Diamond Knurl</b> Symmetrical design and uniform diamond knurl reduces the risk of sink marks. Can be used in mold-in installation.</p>	 <p><b>Non-knurled Symmetrical</b> Symmetrical design with retention groove for use in automation and high-volume applications needing compressive load resistance. Can be used in mold-in installation.</p>
--	--	---	---

## AVAILABLE OPTIONS

Installation Methods	Insert Design Types	Insert Materials	Finishes	Clearance Hole for Mating Screw Sizes:
Ultrasonic Heat Staking Molded-in	Flange-head Symmetrical Full Diamond Knurl Non-knurled Symmetrical	Aluminum, Brass	Plain	#2-56 through 5/16-18 and M2 through M8
		Carbon Steel	Zinc plated, 5µm, colorless	
		Stainless Steel	Passivated and/or tested per ASTM A380	

## SAMPLING OF INSERT DESIGN TYPES

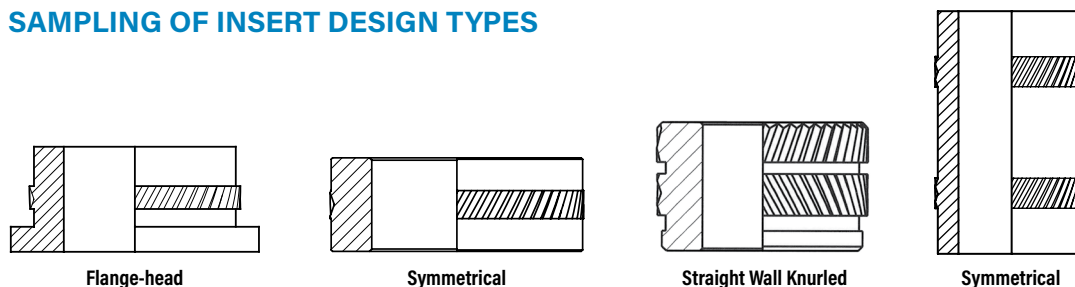

## ULTRASONIC / HEAT STAKING INSERTS

- Ultrasonic - Installed by pressing the insert into the mounting hole with ultrasonic insertion equipment while simultaneously applying a high frequency vibration. Frictional heat caused by the vibration melts the plastic surrounding the insert allowing easy insertion. When the vibration ceases, the plastic solidifies, locking the insert permanently in place.
- Heat Staking - Installed by pressing the insert into the mounting hole with a thermal press to melt the plastic surrounding the insert.

**IUA, IUB, IUC** (Tapered, through threaded inserts) - **Page 5**

**IUTA, IUTB, IUTC** (Straight wall, through threaded inserts) - **Page 6**

**IUTFB** (Flanged, Straight wall, through threaded inserts) - **Page 7**

**ISA, ISB, ISC** (Symmetrical, through threaded inserts) - **Page 8**

**MSIA, MSIB** (microPEM® symmetrical, through threaded inserts) - **Page 9**

Performance data for ultrasonic inserts - **Pages 10-11**



## MOLDED-IN INSERTS

- Installed during the molding process, the inserts are located in the mold cavity by core pins. When the mold opens, the core pins are withdrawn leaving the inserts permanently encapsulated in the plastic section with only the threads exposed.
- Installing the inserts during the molding process eliminates the need for secondary steps or installation equipment.

**IBA, IBB, IBC** (Blind threaded inserts) - **Page 12**

**IBLC** (Self-locking blind threaded inserts) - **Page 13**

**ITA, ITB, ITC** (Through threaded inserts) - **Page 14**

**STKA, STKB, STKC** (Knurled inserts) - **Page 15**

Performance data for molded-in inserts - **Page 16**



## PRESS-IN INSERTS

- Installed by simply pressing the inserts into pre-molded or drilled holes. Installation is accomplished using any standard press at any time during the production process.
- Eliminates the need for molding-in inserts.
- Eliminates the need for heat or ultrasonic equipment.

**NFPC, NFPA** (Hexagonal, press-in inserts) - **Page 17**

**PPA, PPB** (Through threaded inserts) - **Page 18**

**PFLA, PFLB** (Flange-head inserts) - **Page 19**

**PKA, PKB** (Straight knurl inserts) - **Page 20**

Performance data for press-in inserts - **Page 21**



Custom Designs, Hole Preparation Guidelines and SI Prototype Kit - **Page 22-23**

## ULTRASONIC / HEAT STAKING INSERTS

### Tapered Thru-Threaded, IUA™, IUB™ and IUC™ Inserts

- Designed for use in tapered holes.
- Tapered mounting hole allows for rapid and accurate alignment prior to installation.
- Aluminum inserts ideal for light weight designs.
- Aluminum and stainless steel inserts offer lead-free alternative.

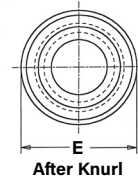
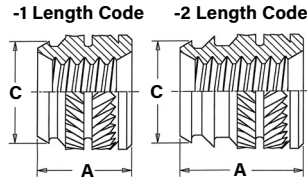
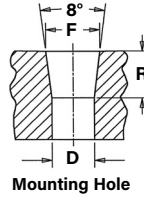
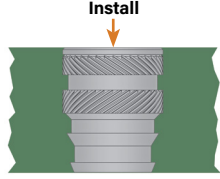

**Diagonal Knurl**  
Thread sizes  
4-40 to 3/8-16  
and M2.5 to M8

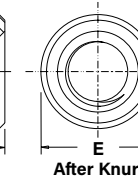
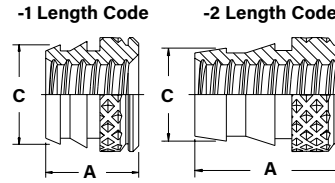

**Diamond Knurl**  
Thread sizes  
0-80, 2-56  
and M2

All dimensions are in inches.

Thread Size	Type			Thread Code (1)	Length Code	A ± .005	E ± .005	C ± .005	Hole Size in Material			
	Aluminum	Brass	Stainless Steel						Min. Hole Depth	D ± .002	F ± .002	R Ref. Taper Length
.060-80 (#0-80)	IUA	IUB	IUC	080	1	.115	.141	.123	.155	.118	.123	.036
					2	.188		.115	.228	.107		.114
.086-56 (#2-56)	IUA	IUB	IUC	256	1	.115	.141	.123	.155	.118	.123	.036
					2	.188		.115	.228	.107		.114
.112-40 (#4-40)	IUA	IUB	IUC	440	1	.135	.172	.157	.175	.153	.159	.043
					2	.219		.149	.259	.141		.129
.138-32 (#6-32)	IUA	IUB	IUC	632	1	.150	.219	.203	.190	.199	.206	.050
					2	.250		.190	.290	.185		.150
.164-32 (#8-32)	IUA	IUB	IUC	832	1	.185	.250	.230	.225	.226	.234	.057
					2	.312		.213	.352	.208		.186
.190-24 (#10-24)	IUA	IUB	IUC	024	1	.225	.297	.272	.265	.267	.277	.072
					2	.375		.251	.415	.246		.222
.190-32 (#10-32)	IUA	IUB	IUC	032	1	.225	.297	.272	.265	.267	.277	.072
					2	.375		.251	.415	.246		.222
.250-20 (1/4-20)	IUA	IUB	IUC	0420	1	.300	.375	.354	.340	.349	.363	.100
					2	.500		.332	.540	.321		.300
.250-28 (1/4-28)	IUA	IUB	IUC	0428	1	.300	.375	.354	.340	.349	.363	.100
					2	.500		.332	.540	.321		.300
.313-18 (5/16-18)	IUA	IUB	IUC	0518	1	.335	.469	.439	.375	.431	.448	.122
					2	.562		.406	.602	.401		.336
.375-16 (3/8-16)	IUA	IUB	IUC	0616	1	.375	.563	.532	.415	.523	.540	.122
					2	.625		.493	.665	.488		.372

All dimensions are in millimeters.

Thread Size x Pitch	Type			Thread Code (1)	Length Code	A ± 0.13	E ± 0.13	C ± 0.13	Hole Size in Material			
	Aluminum	Brass	Stainless Steel						Min. Hole Depth	D ± 0.05	F ± 0.05	R Ref. Taper Length
M2 x 0.4	IUA	IUB	IUC	M2	1	2.92	3.58	3.12	3.94	3	3.12	0.9
M2.5 x 0.45	IUA	IUB	IUC	M2.5	1	3.43	4.37	3.99	4.44	3.89	4.04	1.07
					2	5.56		3.79	6.58	3.58		3.29
M3 x 0.5	IUA	IUB	IUC	M3	1	3.43	4.37	3.99	4.44	3.89	4.04	1.07
					2	5.56		3.79	6.58	3.58		3.29
M3 x 0.5	IUAA	IUBB	IUCC	M3	1	3.81	5.56	5.16	4.83	5.05	5.23	1.29
					2	6.35		4.83	7.42	4.7		3.79
M3.5 x 0.6	IUA	IUB	IUC	M3.5	1	3.81	5.56	5.16	4.83	5.05	5.23	1.29
					2	6.35		4.83	7.42	4.7		3.79
M4 x 0.7	IUA	IUB	IUC	M4	1	4.7	6.35	5.84	5.72	5.74	5.94	1.43
					2	7.92		5.41	8.94	5.28		4.72
M5 x 0.8	IUA	IUB	IUC	M5	1	5.72	7.54	6.91	6.74	6.78	7.03	1.79
					2	9.53		6.38	10.55	6.25		5.58
M5 x 0.8	IUAA	IUBB	IUCC	M5	1	6.71	8.33	7.83	7.72	7.7	8	2.15
					2	11.1		7.16	12.12	7.06		6.72
M6 x 1	IUA	IUB	IUC	M6	1	7.62	9.52	8.99	8.64	8.86	9.22	2.57
					2	12.7		8.43	13.72	8.15		7.65
M8 x 1.25	IUA	IUB	IUC	M8	1	8.51	11.91	11.15	9.53	10.95	11.38	3.07
					2	14.27		10.31	15.29	10.19		8.51

(1) Thread tapped thru, Class 3A/4h screw must pass with finger torque, but basic go gauge may stop at last thread.

## ULTRASONIC / HEAT STAKING INSERTS

### Straight Wall, Thru-Threaded, IUTA™, IUTB™ and IUTC™ Inserts

- Self-aligning lead-in of insert provides for accurate alignment prior to installation.
- Aluminum inserts ideal for light weight designs.
- Aluminum and stainless steel inserts offer lead-free alternative.

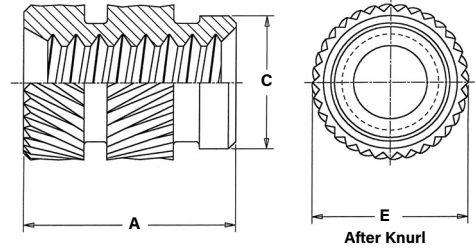
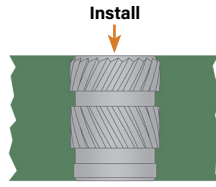

All dimensions are in inches.

Thread Size	Type			Thread Code (1)	Length Code	A ± .005	E ± .005	C ± .005	Hole Size in Material	
	Aluminum	Brass	Stainless Steel						Min. Hole Depth	Hole Dia. +.003 -.000
.086-56 (#2-56)	IUTA	IUTB	IUTC	256	125	.125	.147	.121	.155	.127
					—	.157			.187	
.112-40 (#4-40)	IUTA	IUTB	IUTC	440	135	.135	.179	.152	.165	.158
					—	.226			.256	
.138-32 (#6-32)	IUTA	IUTB	IUTC	632	150	.150	.210	.183	.180	.189
					—	.281			.311	
.164-32 (#8-32)	IUTA	IUTB	IUTC	832	185	.185	.243	.217	.215	.223
					—	.321			.351	
.190-24 (#10-24)	IUTA	IUTB	IUTC	024	225	.225	.273	.247	.255	.253
					—	.375			.405	
.190-32 (#10-32)	IUTA	IUTB	IUTC	032	225	.225	.273	.247	.255	.253
					—	.375			.405	
.250-20 (1/4-20)	IUTA	IUTB	IUTC	0420	300	.300	.342	.310	.330	.316
					312	.312			.530	
					—	.500			.530	
.250-28 (1/4-28)	IUTA	IUTB	IUTC	0428	—	.500	.342	.310	.530	.316
.313-18 (5/16-18)	IUTA	IUTB	IUTC	0518	—	.500	.406	.374	.530	.378
.313-24 (5/16-24)	IUTA	IUTB	IUTC	0524	—	.500	.406	.374	.530	.378
.375-16 (3/8-16)	IUTA	IUTB	IUTC	0616	—	.500	.509	.462	.530	.468
.375-24 (3/8-24)	IUTA	IUTB	IUTC	0624	—	.500	.509	.462	.530	.468

All dimensions are in millimeters.

Thread Size	Type			Thread Code (1)	Length Code	A ± 0.13	E ± 0.13	C ± 0.13	Hole Size in Material	
	Aluminum	Brass	Stainless Steel						Min. Hole Depth	Hole Dia. +0.08
M2 x 0.4	IUTA	IUTB	IUTC	M2	318	3.18	3.73	3.07	3.94	3.23
					—	4			4.76	
M2.5 x 0.45	IUTA	IUTB	IUTC	M2.5	—	5.74	4.55	3.86	6.5	4.01
M3 x 0.5	IUTA	IUTB	IUTC	M3	343	3.43	4.55	3.86	4.19	4.01
					—	5.74			6.5	
M3.5 x 0.6	IUTA	IUTB	IUTC	M3.5	—	7.14	5.33	4.65	7.9	4.81
M4 x 0.7	IUTA	IUTB	IUTC	M4	470	4.7	6.17	5.51	5.46	5.67
					—	8.15			8.91	
M5 x 0.8	IUTA	IUTB	IUTC	M5	572	5.72	6.93	6.27	6.48	6.43
					—	9.52			10.28	
M6 x 1	IUTA	IUTB	IUTC	M6	762	7.62	8.69	7.87	8.38	8.03
					—	12.7			13.46	
M8 x 1.25	IUTA	IUTB	IUTC	M8	—	12.7	10.31	9.5	13.46	9.6

(1) Thread tapped thru, Class 3A/4h screw must pass with finger torque, but basic go gauge may stop at last thread.

## ULTRASONIC / HEAT STAKING INSERTS

### Flanged, Straight Wall, Thru-Threaded, IUTFB™ Inserts

- Provides larger surface area and high pullout in reverse entry applications.
- Brass flange offers a contact surface for electrical connections.
- Flange helps distribute the load applied when fastening mating hardware.
- Self-aligning lead-in provides accurate alignment prior to installation.
- Aluminum and stainless steel available upon request.

**NOW AVAILABLE  
FLANGED HEAD INSERTS**

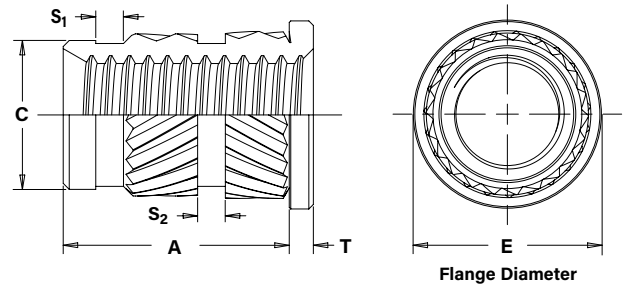
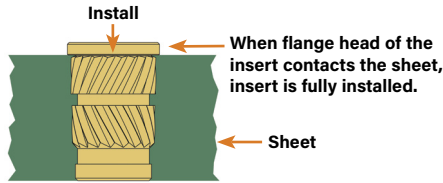

All dimensions are in inches.

UNIFIED	Thread Size	Type	Thread Code (1)	A ± .005	E ± .005	C ± .005	S <sub>1</sub> Nom.	S <sub>2</sub> Nom.	T ± .005	Hole Size in Material	
	Brass	Min. Hole Depth								Hole Dia. + .003 - .000	
	.086-56 (#2-56)	IUTFB	256	.157	.187	.121	.021	.021	0.18	.187	.127
	.112-40 (#4-40)	IUTFB	440	.226	.218	.152	.031	.031	.021	.256	.158
	.138-32 (#6-32)	IUTFB	632	.281	.250	.183	.031	.031	.027	.311	.189
	.164-32 (#8-32)	IUTFB	832	.321	.281	.217	.040	.031	.033	.351	.223
	.190-24 (#10-24)	IUTFB	024	.375	.312	.247	.046	.046	.040	.405	.253
	.190-32 (#10-32)	IUTFB	032	.375	.312	.247	.046	.046	.040	.405	.253
	.250-20 (1/4-20)	IUTFB	0420	.500	.375	.310	.062	.046	.050	.530	.316
	.250-28 (1/4-28)	IUTFB	0428	.500	.375	.310	.062	.046	.050	.530	.316
	.375-16 (3/8-16)	IUTFB	0616	.500	.550	.462	.062	.046	.065	.530	.468

All dimensions are in millimeters.

UNIFIED	Thread Size x Pitch	Type	Thread Code (1)	A ± 0.13	E ± 0.13	C ± 0.13	S <sub>1</sub> Nom.	S <sub>2</sub> Nom.	T ± 0.13	Hole Size in Material	
	Brass	Min. Hole Depth								Hole Dia. + 0.08	
	M2 x 0.4	IUTFB	M2	3.99	4.75	3.07	0.53	0.53	0.46	4.76	3.23
	M2.5 x 0.45	IUTFB	M2.5	5.74	5.54	3.86	0.79	0.79	0.53	6.5	4.01
	M3 x 0.5	IUTFB	M3	5.74	5.54	3.86	0.79	0.79	0.53	6.5	4.01
	M3.5 x 0.6	IUTFB	M3.5	7.14	6.35	4.65	0.79	0.79	0.69	7.9	4.81
	M4 x 0.7	IUTFB	M4	8.15	7.14	5.51	1.02	0.79	0.84	8.91	5.67
	M5 x 0.8	IUTFB	M5	9.53	7.92	6.27	1.17	1.17	1.02	10.28	6.43
	M6 x 1	IUTFB	M6	12.7	9.53	7.87	1.58	1.17	1.27	13.46	8.03

(1) Thread tapped thru, Class 3A/4h screw must pass with finger torque, but basic go gauge may stop at last thread.

## ULTRASONIC / HEAT STAKING INSERTS

### Symmetrical, Thru-Threaded, ISA™, ISB™ and ISC™ Inserts

- Symmetrical design eliminates the need for orientation.
- Aluminum inserts ideal for light weight designs.
- Aluminum and stainless steel inserts offer lead-free alternative.

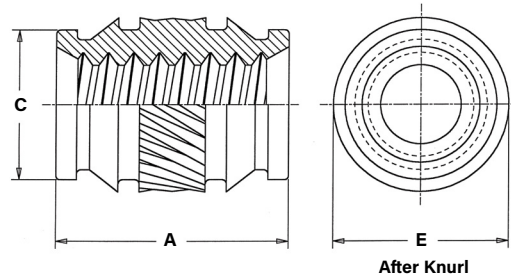

All dimensions are in inches.

UNIFIED	Thread Size	Type			Thread Code (1)	A ± .005	E ± .005	C ± .003	Hole Size in Material	
		Aluminum	Brass	Stainless Steel					Hole Depth	Hole Dia. +.003-.000
	.086-56 (#2-56)	ISA	ISB	ISC	256	.157	.151	.122	.187	.126
	.112-40 (#4-40)	ISA	ISB	ISC	440	.226	.182	.153	.256	.157
	.138-32 (#6-32)	ISA	ISB	ISC	632	.281	.215	.184	.311	.188
	.164-32 (#8-32)	ISA	ISB	ISC	832	.321	.245	.217	.351	.221
	.190-32 (#10-32)	ISA	ISB	ISC	032	.375	.276	.248	.405	.252
	.250-20 (1/4-20)	ISA	ISB	ISC	0420	.500	.338	.311	.530	.315

All dimensions are in millimeters.

METRIC	Thread Size x Pitch	Type			Thread Code (1)	A ± 0.13	E ± 0.13	C ± 0.08	Hole Size in Material	
		Aluminum	Brass	Stainless Steel					Hole Depth	Hole Dia. +0.08
	M3 x 0.5	ISA	ISB	ISC	M3	5.74	4.62	3.88	6.5	3.99
	M4 x 0.7	ISA	ISB	ISC	M4	8.15	6.22	5.51	8.92	5.62
	M5 x 0.8	ISA	ISB	ISC	M5	9.52	7.01	6.3	10.29	6.4
	M6 x 1	ISA	ISB	ISC	M6	12.7	8.58	7.9	13.46	8

(1) Thread tapped thru, Class 3A/4h screw must pass with finger torque, but basic go gauge may stop at last thread.



## ULTRASONIC / HEAT STAKING INSERTS

### microPEM® Symmetrical, Thru-Threaded, MSIA™ MSIB™ Inserts

- Threads as small as M1.
- Symmetrical design eliminates the need for orientation.
- Provides excellent performance in wide range of plastics.
- Aluminum inserts ideal for light weight designs.
- Aluminum inserts offer lead-free alternative.

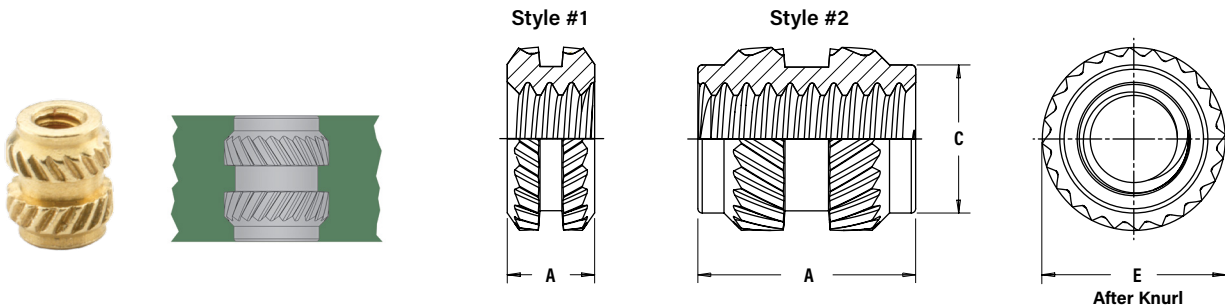

All dimensions are in millimeters.

METRIC	Thread Size x Pitch	Type		Thread Code	Length Code	A ±0.1	E ±0.1	C Max.	Mounting Hole in Material		
		Aluminum	Brass						Min. Wall Thickness (6)	Hole Depth Min.	Hole Diameter +0.05
	M1 x 0.25 (3)	MSIA	MSIB	M1	100(1)	1	2.1	—	0.7	1.77	1.75
					250(2)	2.5		1.75		3.27	
	M1.2 x 0.25 (3)	MSIA	MSIB	M1.2	100(1)	1	2.1	—	0.7	1.77	1.75
					250(2)	2.5		1.75		3.27	
	M1.4 x 0.3 (4)	MSIA	MSIB	M1.4	150(2)	1.5	2.5	2.15	0.8	2.27	2.15
					300(2)	3				3.77	
M1.6 x 0.35 (5)	MSIA	MSIB	M1.6	150(2)	1.5	2.5	2.15	0.8	2.27	2.15	
				300(2)	3				3.77		
M2 x 0.4 (5)	MSIA	MSIB	M2	300(2)	3	3.2	2.85	1.6	3.77	2.85	
				400(2)	4				4.77		

- (1) Style #1 - length codes less than 150
- (2) Style #2 - length codes 150 and greater
- (3) Metric ISO 68-1, 5H
- (4) Metric ISO 68-1, 6H
- (5) Metric ASME B1.13M, 6H
- (6) Refers to wall diameter of boss as tested in ABS and polycarbonate.

**microPEM®**  
**FASTENERS**

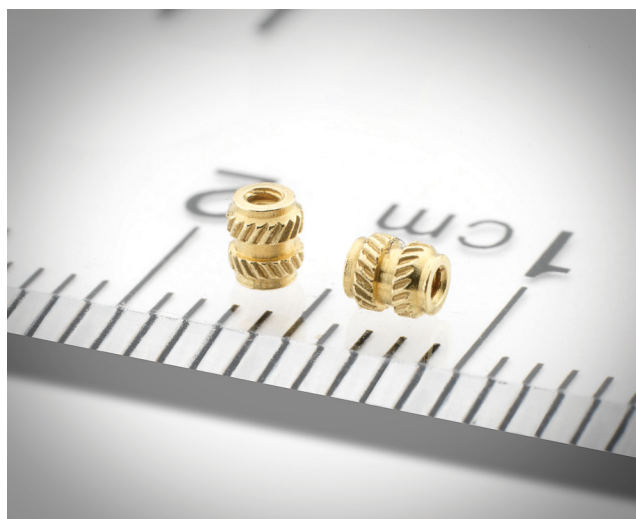

## PERFORMANCE DATA FOR ULTRASONIC / HEAT STAKING INSERTS

### IUA, IUB, IUBB, IUC, and IUCC Inserts (1)

UNIFIED	Thread Code	ABS		Polycarbonate	
		Pullout (lbs.)	Torque-out (in. lbs.)	Pullout (lbs.)	Torque-out (in. lbs.)
080-1	75	3	90	3	
080-2	75	3	90	3	
256-1	75	3	90	6	
256-2	75	3	90	6	
440-1	80	4	160	7	
440-2	80	4	160	7	
632-1	145	15	165	18	
632-2	275	15	450	24	
832-1	205	18	295	20	
832-2	370	19	645	20	
024-1	270	45	430	55	
024-2	560	60	910	80	
032-1	270	45	430	55	
032-2	560	60	910	80	
0420-1	374	65	614	85	
0420-2	680	65	1415	108	

METRIC	Thread Code	ABS		Polycarbonate	
		Pullout (N)	Torque-out (N-m)	Pullout (N)	Torque-out (N-m)
M2-1	334	0.3	400	0.7	
M2.5-1	334	0.3	400	0.7	
M2.5-2	334	0.3	400	0.7	
M3-1	356	0.5	712	0.8	
M3-2	356	0.5	712	0.8	
M3.5-1	645	1.7	734	2	
M3.5-2	1223	1.7	2002	2.7	
M4-1	912	2	1312	2.3	
M4-2	1646	2.1	2869	2.3	
M5-1	1201	5.1	1913	6.2	
M5-2	2491	6.8	4048	9	
M6-1	1664	7.3	2731	9.6	
M6-2	3025	7.3	6294	12.2	

### IUTA, IUTB, IUTC Inserts(1)

UNIFIED	Thread Code	ABS		Polycarbonate	
		Pullout (lbs.)	Torque-out (in. lbs.)	Pullout (lbs.)	Torque-out (in. lbs.)
256-125	57	4	98	8	
256	57	4	98	8	
440-135	74	8	113	13	
440	165	14	185	16	
632-150	100	18	150	19	
632	197	25	295	31	
832-185	108	20	156	34	
832	216	36	365	52	
024-225	213	32	225	47	
024	269	54	380	80	
032-225	213	32	225	47	
032	269	54	380	80	
0420-300 & 312	271	84	293	105	
0420	480	103	600	132	
0428	480	103	600	132	
0518	802	114	641	113	
0524	802	114	641	113	
0616	824	234	921	232	
0624	824	234	921	232	

METRIC	Thread Code	ABS		Polycarbonate	
		Pullout (N)	Torque-out (N-m)	Pullout (N)	Torque-out (N-m)
M2-318	253	0.45	436	0.91	
M2	253	0.45	436	0.91	
M2.5	730	1.6	823	1.8	
M3-343	330	0.91	502	1.5	
M3	730	1.6	823	1.8	
M3.5	876	2.83	1311	3.5	
M4-470	482	2.3	694	3.8	
M4	963	4.1	1710	5.9	
M5-572	948	3.6	999	5.3	
M5	1197	5.4	1691	7.7	
M6-762	1207	10	1305	12	
M6	2130	11.7	2660	14.9	
M8	3566	26	4098	26	

### IUTFB Inserts(1)

UNIFIED	Thread Code	ABS		Polycarbonate	
		Pullout (lbs.)	Torque-out (in. lbs.)	Pullout (lbs.)	Torque-out (in. lbs.)
256	57	4	112	8	
440	165	14	185	16	
632	197	25	295	31	
832	216	36	365	52	
024	269	54	380	80	
032	269	54	380	80	
0420	480	103	600	132	
0428	480	103	600	132	
0616	516	285	620	378	

METRIC	Thread Code	ABS		Polycarbonate	
		Pullout (N)	Torque-out (N-m)	Pullout (N)	Torque-out (N-m)
M2	255	0.5	578	0.9	
M2.5	730	1.6	823	1.8	
M3	730	1.6	823	1.8	
M3.5	878	3.1	1417	3.8	
M4	963	4.1	1710	5.9	
M5	1197	5.4	1691	7.7	
M6	2130	11.7	2660	14.9	

(1) The values reported are averages for ultrasonically inserted inserts when all installation specifications and procedures are followed. Variations in mounting hole size, sheet material and installation procedure will affect results. Performance testing of this product in your application is recommended. Samples can be provided for this purpose.

## PERFORMANCE DATA FOR ULTRASONIC / HEAT STAKING INSERTS

### ISA, ISB and ISC Inserts(1)

UNIFIED	Thread Code	ABS		Polycarbonate	
		Pullout (lbs.)	Torque-out (in. lbs.)	Pullout (lbs.)	Torque-out (in. lbs.)
	256	85.5	6.14	149.4	6.37
440	151.37	14.38	344.94	23.17	
632	320.3	21.69	405.9	18.19	
832	462.9	31.7	663.9	57.15	
032	549.6	52.3	1015.4	71.79	
0420	600.45	100.25	-	-	

METRIC	Thread Code	ABS		Polycarbonate	
		Pullout (N)	Torque-out (N-m)	Pullout (N)	Torque-out (N-m)
	M3	680	1.62	1550	2.6
M4	2080	3.58	2980	6.45	
M5	2470	5.9	4560	8.11	
M6	2700	11.1	-	-	

### MSIA and MSIB Inserts(1)

METRIC	Thread Code	Length Code	ABS		Polycarbonate	
			Pullout (N)	Torque-out (N-cm) (2)	Pullout (N)	Torque-out (N-cm) (2)
	M1		100	50	3.5	50
250			150	10	200	12
M1.2		100	50	3.5	50	4.5
		250	150	10	200	12
M1.4		150	100	15	140	15
		300	330	30	400	30
M1.6		150	100	15	140	15
		300	330	30	400	30
M2		300	335	35	410	33
		400	470	40	595	35

- (1) The values reported are averages for ultrasonically inserted inserts when all installation specifications and procedures are followed. Variations in mounting hole size, sheet material and installation procedure will affect results. Performance testing of this product in your application is recommended. Samples can be provided for this purpose.
- (2) Torque-out performance will depend on the strength and type of screw being used. In most cases, the screw threads will fail before the insert threads. For testing purposes, inserts were installed using heat stake equipment into a flat sheet.

## MOLDED-IN INSERTS

### Blind Threaded, IBA™, IBB™ and IBC™ Inserts

- Blind-end protects the threads from plastic intrusion.
- Aluminum inserts ideal for light weight designs.
- Aluminum and stainless steel inserts offer lead-free alternative.



**NOTE:** Manufacturing techniques may leave a slight projection a maximum of .025" / 0.65 mm beyond the "A" dimension.

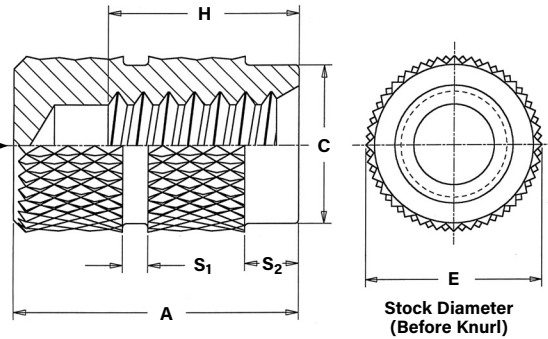

All dimensions are in inches.

UNIFIED	Thread Size	Type			Thread Code	Length A ± .005 / H Min.					E Nom.	C ± .005	S <sub>1</sub> Nom.	S <sub>2</sub> Nom.	Minor Dia. Min./Max.
		Aluminum	Brass	Stainless Steel		Min. No. of Full Threads									
						4	6	8	10	12					
.086-56 (#2-56)	IBA	IBB	IBC	256	.156/.080	.219/.115	.250/.150	.312/.185	.344/.220	.156	.142	.03	.03	.067/.0737	
.112-40 (#4-40)	IBA	IBB	IBC	440	.205/.110	.281/.160	.344/.210	.406/.260	.438/.310	.188	.171	.03	.03	.086/.0939	
.138-32 (#6-32)	IBA	IBB	IBC	632	.250/.135	.344/.200	.406/.260	.469/.325	.531/.385	.219	.202	.03	.06	.105/.114	
.164-32 (#8-32)	IBA	IBB	IBC	832	.250/.135	.344/.200	.406/.260	.469/.325	.531/.385	.250	.226	.05	.06	.131/.139	
.190-24 (#10-24)	IBA	IBB	IBC	024	.356/.175	.438/.260	.531/.345	.625/.425	.716/.510	.281	.259	.05	.06	.146/.156	
.190-32 (#10-32)	IBA	IBB	IBC	032	.281/.135	.438/.200	.531/.260	.469/.325	.531/.385	.281	.259	.05	.06	.157/.164	
.250-20 (1/4-20)	IBA	IBB	IBC	0420	.344/.200	.531/.315	.625/.415	.719/.515	.819/.615	.344	.321	.06	.09	.197/.207	
.313-18 (5/16-18)	IBA	IBB	IBC	0518	.438/.235	.594/.345	.719/.460	.811/.570	.949/.680	.438	.404	.078	.094	.254/.265	
.375-16 (3/8-16)	IBA	IBB	IBC	0616	.500/.265	.688/.390	.812/.515	.935/.640	1.00/.765	.500	.466	.094	.094	.309/.321	

All dimensions are in millimeters.

METRIC	Thread Size x Pitch	Type			Thread Code	Length A ± 0.13 / H Min.					E Nom.	C ± 0.13	S <sub>1</sub> Nom.	S <sub>2</sub> Nom.	Minor Dia. Min./Max.
		Aluminum	Brass	Stainless Steel		Min. No. of Full Threads									
						4	6	8	10	12					
M2.5 x 0.45	IBA	IBB	IBC	M2.5	4.78/2.01	6.35/2.87	7.14/3.74	9.53/4.6	10.31/5.47	4.78	4.34	0.8	0.8	2.03/2.14	
M3 x 0.5	IBA	IBB	IBC	M3	5.21/2.21	7.13/3.21	8.73/4.21	10.31/5.21	11.13/6.21	4.78	4.34	0.8	0.8	2.47/2.59	
M3.5 x 0.6	IBA	IBB	IBC	M3.5	6.35/2.62	8.73/3.81	10.31/5.02	11.91/6.22	13.48/7.42	5.56	5.13	0.8	1.6	2.87/3.01	
M4 x 0.7	IBA	IBB	IBC	M4	6.35/3.08	8.73/4.47	10.31/5.89	11.91/7.29	13.48/8.69	6.35	5.74	1.2	1.6	3.25/3.42	
M5 x 0.8	IBA	IBB	IBC	M5	7.13/3.49	11.12/5.09	13.48/6.69	11.91/8.29	13.48/9.89	7.14	6.57	1.2	1.6	4.15/4.34	
M6 x 1	IBA	IBB	IBC	M6	8.73/4.37	13.49/6.37	15.87/8.37	18.26/10.57	20.8/12.37	8.74	8.15	1.6	2.4	4.94/5.16	
M8 x 1.25	IBA	IBB	IBC	M8	11.13/5.72	15.09/7.82	18.24/10.32	20.62/12.82	22.23/15.32	11.13	10.26	1.98	2.4	6.68/6.92	

## MOLDED-IN INSERTS

### Self-Locking, Blind Threaded, IBLC™ Inserts

- Deformed threads create prevailing torque locking feature to prevent screw loosening due to vibration.
- Blind-end protects the threads from plastic intrusion.
- Stainless steel inserts offer lead-free alternative.

#### Style #1

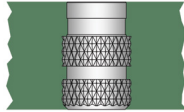

**NOTE:** Manufacturing techniques may leave a slight projection a maximum of .025"/0.65 mm beyond the "A" dimension.

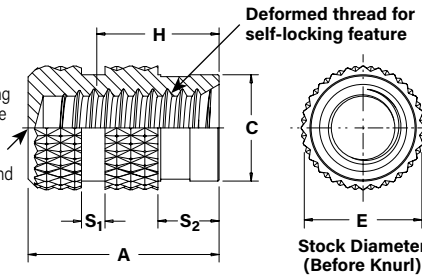

#### PART NUMBER DESIGNATION

**IBLC** - **832** - **8**  
 ↓                      ↓                      ↓  
 Type and Material    Thread Code    Length Code

#### Style #2

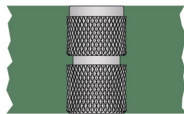

**NOTE:** Manufacturing techniques may leave a slight projection a maximum of .025"/0.65 mm beyond the "A" dimension.

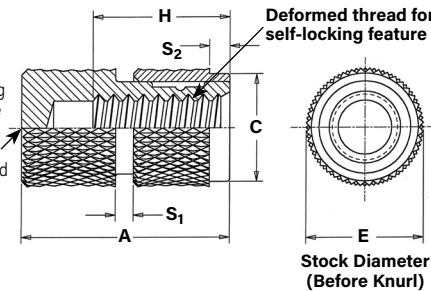

#### PART NUMBER DESIGNATION

**IBLC** - **832** - **8ASSY**  
 ↓                      ↓                      ↓  
 Type and Material    Thread Code    Length Code

All dimensions are in inches.

UNIFIED	Thread Size	Type	Thread Code	Length Code		A ± .005	E Nom.	C ±.005		S <sub>1</sub> ± .005	S <sub>2</sub> ±.005		Minor Dia. Min./Max. (1)	H Min.	First Cycle on Locking Torque (in. lbs.) (2)	
				Style #1	Style #2			Style #1	Style #2		Style #1	Style #2			Min.	Max.
				.086-56 (#2-56)	IBLC			256	N/A		8ASSY	.250			.156	N/A
.112-40 (#4-40)	IBLC	440	8	8ASSY	.344	.188	.171	.180	.030	.130	.030	.086/.0939	.210	0.5	5	
.138-32 (#6-32)	IBLC	632	8	8ASSY	.406	.219	.195	.200	.050	.130	.030	.105/.114	.260	1	10	
.164-32 (#8-32)	IBLC	832	8	8ASSY	.406	.250	.226	.235	.050	.130	.060	.131/.139	.260	1.5	15	
.190-32 (#10-32)	IBLC	032	8	8ASSY	.531	.281	.259	.270	.050	.130	.060	.157/.164	.260	2	18	
.250-20 (1/4-20)	IBLC	0420	8	8ASSY	.625	.344	.298	.325	.060	.150	.060	.197/.207	.415	4.5	30	

All dimensions are in millimeters.

METRIC	Thread Size x Pitch	Type	Thread Code	Length Code		A ± 0.13	E Nom.	C ±0.13		S <sub>1</sub> ± 0.13	S <sub>2</sub> ±0.13		Minor Dia. Min./Max. (1)	H Min.	First Cycle on Locking Torque (N·m) (2)	
				Style #1	Style #2			Style #1	Style #2		Style #1	Style #2			Min.	Max.
				M3 x 0.5	IBLC			M3	8		8ASSY	8.73			4.78	4.34
M4 x 0.7	IBLC	M4	8	8ASSY	10.31	6.35	5.74	5.97	1.2	3.3	1.6	3.26/3.42	5.89	0.16	1.6	
M5 x 0.8	IBLC	M5	8	8ASSY	13.48	7.14	6.58	6.86	1.2	3.3	1.6	4.15/4.34	6.69	0.23	2.1	
M6 x 1	IBLC	M6	8	8ASSY	15.87	8.73	7.57	8.26	1.6	3.8	2.4	4.95/5.15	8.37	0.37	3.2	

N/A - Not Available.

(1) Minor diameter may be below minimum in deformed thread area.

(2) Locking torque values shown apply when the mating screw has thread class of 3A for unified sizes and class 4h for metric sizes and is made from 300 series stainless steel with no additive finish. Other screws may be used, but the locking torque may not comply with the values shown.

## MOLDED-IN INSERTS

### Thru-Threaded, ITA™, ITB™ and ITC™ Inserts

- Pilot diameter and undercuts allow plastic to flow into grooves providing high pullout resistance.
- Aluminum inserts ideal for light weight designs.
- Aluminum and stainless steel inserts offer lead-free alternative.

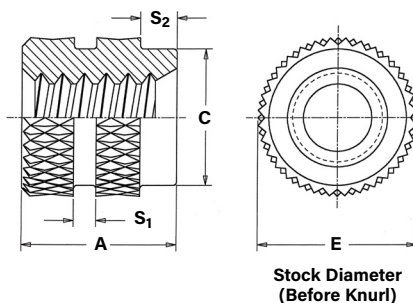
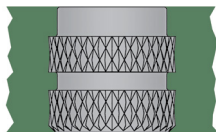

All dimensions are in inches.

	Thread Size	Type			Thread Code (1)	A ± .005	E Nom.	C ± .005	S <sub>1</sub> Nom.	S <sub>2</sub> Nom.	Minor Dia. Min./Max.
		Aluminum	Brass	Stainless Steel							
UNIFIED	.060-80 (#0-80)	ITA	ITB	ITC	080	.125	.109	.078	.03	.03	.0475/.051
	.086-56 (#2-56)	ITA	ITB	ITC	256	.125	.156	.142	.03	.03	.067/.0737
	.112-40 (#4-40)	ITA	ITB	ITC	440	.188	.188	.171	.03	.03	.086/.0939
	.138-32 (#6-32)	ITA	ITB	ITC	632	.219	.219	.202	.03	.06	.105/.114
	.164-32 (#8-32)	ITA	ITB	ITC	832	.250	.250	.226	.05	.06	.131/.139
	.190-24 (#10-24)	ITA	ITB	ITC	024	.281	.281	.259	.05	.06	.146/.156
	.190-32 (#10-32)	ITA	ITB	ITC	032	.281	.281	.259	.05	.06	.157/.164
	.250-20 (1/4-20)	ITA	ITB	ITC	0420	.375	.344	.321	.06	.09	.197/.207
	.250-28 (1/4-28)	ITA	ITB	ITC	0428	.375	.344	.321	.06	.09	.212/.220
	.313-18 (5/16-18)	ITA	ITB	ITC	0518	.469	.437	.404	.08	.09	.254/.265
	.375-16 (3/8-16)	ITA	ITB	ITC	0616	.562	.500	.466	.09	.09	.309/.321

All dimensions are in millimeters.

	Thread Size x Pitch	Type			Thread Code (1)	A ± 0.13	E Nom.	C ± 0.13	S <sub>1</sub> Nom.	S <sub>2</sub> Nom.	Minor Dia. Min./Max.
		Aluminum	Brass	Stainless Steel							
METRIC	M3 x 0.5	ITA	ITB	ITC	M3	4.77	4.77	4.34	0.78	0.78	2.47/2.59
	M4 x 0.7	ITA	ITB	ITC	M4	6.35	6.35	5.74	1.16	1.57	3.25/3.42
	M5 x 0.8	ITA	ITB	ITC	M5	7.13	7.13	6.57	1.16	1.57	4.15/4.34
	M6 x 1	ITA	ITB	ITC	M6	9.53	8.74	8.15	1.57	2.38	4.94/5.16
	M8 x 1.25	ITA	ITB	ITC	M8	11.91	11.1	10.26	2.03	2.28	6.68/6.92
	M10 x 1.5	ITA	ITB	ITC	M10	14.27	12.7	11.84	2.38	2.38	8.55/8.67

(1) Thread tapped thru, Class 3A/4h screw must pass with finger torque, but basic go gauge may stop at last thread.

## MOLDED-IN INSERTS

### Thru-Threaded, Knurled, STKA™, STKB™ and STKC™ Inserts

- Uniform knurl diameter reduces the risk of sink marks.
- Available in varying lengths for injection molding assemblies.
- Aluminum inserts ideal for light weight designs.
- Aluminum and stainless steel inserts offer lead-free alternative.

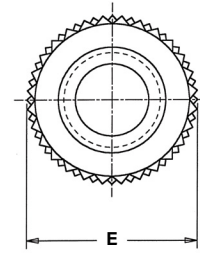
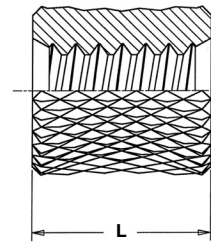
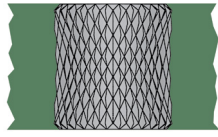

Stock Diameter  
(Before Knurl)

All dimensions are in inches.

UNIFIED	Thread Size	Type			Thread Code (I)	Length Code "L" ± .005 in 32nds of an Inch								E Nom.	Minor Dia. Min./Max.
		Aluminum	Brass	Stainless Steel		.125	.187	.250	.312	.375	.500	.625	.750		
	.086-56 (#2-56)	STKA	STKB	STKC	256	4	6	8	10	12	16	—	—	.156	.067/.0737
.112-40 (#4-40)	STKA	STKB	STKC	440	4	6	8	10	12	16	—	—	.188	.086/.0939	
.138-32 (#6-32)	STKA	STKB	STKC	632	4	6	8	10	12	16	20	24	.219	.105/.114	
.164-32 (#8-32)	STKA	STKB	STKC	832	4	6	8	10	12	16	20	24	.250	.131/.139	
.190-32 (#10-32)	STKA	STKB	STKC	032	4	6	8	10	12	16	20	24	.281	.157/.164	
.250-20 (1/4-20)	STKA	STKB	STKC	0420	4	6	8	10	12	16	20	24	.375	.197/.207	
.313-18 (5/16-18)	STKA	STKB	STKC	0518	4	6	8	10	12	16	20	24	.437	.254/.265	
.375-16 (3/8-16)	STKA	STKB	STKC	0616	4	6	8	10	12	16	20	—	.500	.309/.321	

All dimensions are in millimeters.

METRIC	Thread Size x Pitch	Type			Thread Code (I)	Length Code "L" ± 0.13 in millimeters								E Nom.	Minor Dia. Min./Max.
		Aluminum	Brass	Stainless Steel		3	4	6	8	10	12	15	18		
M3 x 0.5	STKA	STKB	STKC	M3	3	4	6	8	10	12	15	18	4.74	2.47/2.59	
M4 x 0.7	STKA	STKB	STKC	M4	3	4	6	8	10	12	15	18	6.35	3.25/3.42	
M5 x 0.8	STKA	STKB	STKC	M5	3	4	6	8	10	12	15	18	7.13	4.15/4.34	

(1) Thread tapped thru, Class 3A/4h screw must pass with finger torque, but basic go gauge may stop at last thread.

## PERFORMANCE DATA FOR MOLDED-IN INSERTS

### IBA, IBB and IBC Inserts(1)

UNIFIED	Thread Code	Length Code	ABS		Polycarbonate	
			Pullout (lbs.)	Torque-out (in. lbs.)	Pullout (lbs.)	Torque-out (in. lbs.)
256		4	147 / 139	5.7 / 5.4	164 / 157	6.1 / 5.7
		6	148 / 140	5.8 / 5.5	165 / 158	6.2 / 5.8
		8	149 / 142	5.9 / 5.6	166 / 159	6.3 / 5.85
		10	150 / 143	6 / 5.7	167 / 160	6.4 / 5.9
440		12	151 / 145	6.1 / 5.8	168 / 161	6.5 / 6
		4	249 / 239	6.1 / 5.6	264 / 249	6.8 / 6.4
		6	250 / 240	6.2 / 5.7	265 / 253	6.9 / 6.5
		8	251 / 242	6.3 / 5.8	267 / 258	6.95 / 6.55
632		10	252 / 243	6.4 / 5.9	268 / 262	7 / 6.6
		12	253 / 245	6.5 / 6	270 / 267	7.1 / 6.7
		4	424 / 413	8.5 / 7.9	454 / 434	9.1 / 8.6
		6	425 / 415	8.5 / 8	455 / 440	9.2 / 8.7
832		8	427 / 418	8.6 / 8.1	457 / 446	9.25 / 8.75
		10	428 / 420	8.6 / 8.2	458 / 452	9.3 / 8.8
		12	431 / 423	8.7 / 8.3	460 / 458	9.4 / 8.9
		4	529 / 519	14.6 / 13.7	544 / 534	15.9 / 15.2
032		6	530 / 521	15 / 14.1	545 / 536	16.1 / 15.4
		8	532 / 524	14.5 / 14.6	546 / 538	16.3 / 15.6
		10	533 / 526	15.8 / 15	547 / 540	16.4 / 15.8
		12	535 / 529	16.2 / 15.5	548 / 542	16.6 / 16
0420		4	634 / 622	56.5 / 51	647 / 637	58 / 55
		6	635 / 624	57 / 52	648 / 640	59 / 56
		8	636 / 627	57.5 / 53	650 / 643	59.5 / 56.5
		10	637 / 629	58 / 54	651 / 646	60 / 57
		12	638 / 632	58.5 / 55	653 / 649	61 / 58
		6	910 / 895	108 / 103	928 / 912	111 / 107

METRIC	Thread Code	Length Code	ABS		Polycarbonate	
			Pullout (N)	Torque-out (N-m)	Pullout (N)	Torque-out (N-m)
M2.5/M3		4	1105 / 1050	0.69 / 0.63	1160 / 1100	0.76 / 0.73
		6	1110 / 1060	0.7 / 0.64	1170 / 1120	0.77 / 0.73
		8	1115 / 1070	0.71 / 0.65	1180 / 1140	0.78 / 0.74
		10	1120 / 1080	0.72 / 0.66	1190 / 1160	0.79 / 0.74
M4		12	1125 / 1090	0.73 / 0.67	1200 / 1180	0.8 / 0.75
		4	2340 / 2300	1.66 / 1.54	2415 / 2370	1.79 / 1.72
		6	2350 / 2310	1.69 / 1.59	2420 / 2380	1.81 / 1.74
		8	2360 / 2320	1.74 / 1.64	2425 / 2390	1.83 / 1.77
M5		10	2370 / 2330	1.78 / 1.69	2430 / 2400	1.85 / 1.79
		12	2380 / 2340	1.83 / 1.74	2435 / 2410	1.87 / 1.82
		4	2815 / 2760	6.39 / 5.8	2870 / 2825	6.6 / 6.26
		6	2820 / 2770	6.44 / 5.87	2880 / 2840	6.66 / 6.32
M6		8	2825 / 2780	6.5 / 5.94	2885 / 2855	6.72 / 6.38
		10	2830 / 2790	6.55 / 6.1	2890 / 2870	6.78 / 6.44
		12	2835 / 2800	6.61 / 6.17	2895 / 2885	6.84 / 6.7
		6	4040 / 3980	12.2 / 11.6	4120 / 4050	12.5 / 12

### IBLC Inserts(1)

UNIFIED	Thread Code	ABS		Polycarbonate	
		Pullout (lbs.)	Torque-out (in. lbs.)	Pullout (lbs.)	Torque-out (in. lbs.)
	256	128 / 118	5 / 4.6	142 / 134	5.8 / 5
	440	230 / 220	6 / 5.5	238 / 226	6.8 / 6.2
	632	392 / 378	7.8 / 7	406 / 390	9 / 8.2
	832	496 / 480	11 / 9	500 / 468	14 / 13
	032	592 / 580	40 / 30	592 / 564	48 / 42
	0420	760 / 738	90 / 78	798 / 780	99 / 84

METRIC	Thread Code	ABS		Polycarbonate	
		Pullout (N)	Torque-out (N-m)	Pullout (N)	Torque-out (N-m)
	M3	1020 / 970	0.67 / 0.62	1050 / 1000	0.76 / 0.7
	M4	2200 / 2130	1.24 / 1.01	2220 / 2080	1.58 / 1.46
	M5	2630 / 2570	4.52 / 3.39	2630 / 2500	5.42 / 4.74
	M6	3380 / 3280	10.1 / 8.81	3540 / 3460	11.1 / 9.49

### ITA, ITB and ITC Inserts(1)

UNIFIED	Thread Code	ABS		Polycarbonate	
		Pullout (lbs.)	Torque-out (in. lbs.)	Pullout (lbs.)	Torque-out (in. lbs.)
	080/256	104 / 96	5.6 / 5.2	115 / 106	6 / 5.6
	440	175 / 166	6 / 5.5	186 / 173	6.9 / 6.2
	632	298 / 290	8 / 7.5	318 / 302	9 / 8.5
	832	370 / 368	14 / 13.6	382 / 372	16 / 14.7
	032	444 / 432	55 / 50	454 / 445	57 / 52
	0420/0428	635 / 620	75 / 70	650 / 635	103 / 98

METRIC	Thread Code	ABS		Polycarbonate	
		Pullout (N)	Torque-out (N-m)	Pullout (N)	Torque-out (N-m)
	M3	770 / 730	0.67 / 0.62	820 / 760	0.77 / 0.7
	M4	1640 / 1630	1.58 / 1.53	1690 / 1650	1.8 / 1.66
	M5	1970 / 1920	6.22 / 5.65	2010 / 1970	6.44 / 5.87
	M6	2820 / 2750	8.47 / 7.91	2890 / 2820	11.6 / 11

(1) The values reported are high and low ranges when all installation specifications and procedures are followed. Variations in mounting hole size, workpiece material and installation procedure will affect results. Performance testing of this product in your application is recommended. Samples can be provided for this purpose.



## PRESS-IN INSERTS

### Hexagonal, NFPA™ and NFPC™ Inserts

- Press-fit insert provides strong, reusable threads. No heat or ultrasonics required.
- Hexagonal “barbed” configuration ensures high torque-out and pullout values.
- Aluminum inserts ideal for light weight designs.
- Aluminum and stainless steel inserts offer lead-free alternative.

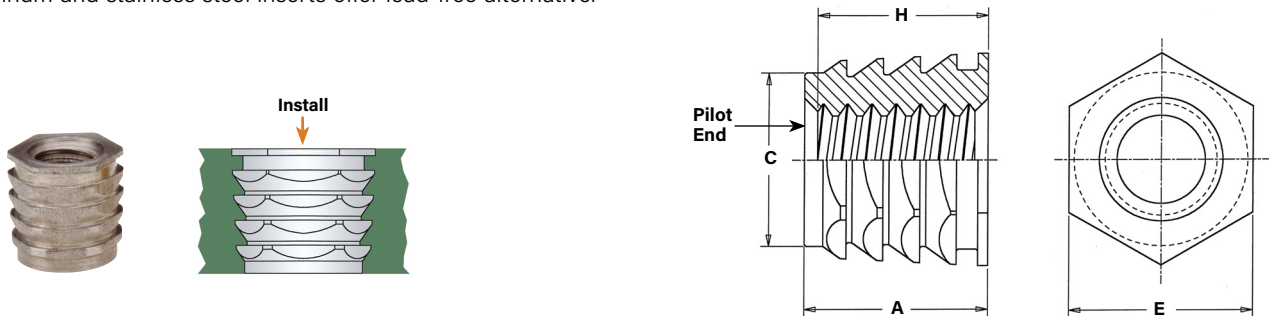

All dimensions are in inches.

UNIFIED	Thread Size (#2-56)	Type		Thread Code	A Max.	Min. Material Thickness	Hole Size in Material + .003 - .000	C Max.	E Nom.	Min. Boss Dia.	Min. Depth Full Thread H <sup>(1)</sup>
		Aluminum	Stainless Steel								
	.086-56 (#2-56)	NFPA	NFPC	256	.230	.240	.187	.186	.187	.500	.212
	.112-40 (#4-40)	NFPA	NFPC	440	.230	.240	.187	.186	.187	.500	.212
	.138-32 (#6-32)	NFPA	NFPC	632	.230	.240	.187	.186	.187	.500	.212
	.164-32 (#8-32)	NFPA	NFPC	832	.265	.275	.250	.249	.250	.625	.248
	.190-24 (#10-24)	NFPA	NFPC	024	.265	.275	.250	.249	.250	.625	.248
	.190-32 (#10-32)	NFPA	NFPC	032	.265	.275	.250	.249	.250	.625	.248
	.250-20 (1/4-20)	NFPA	NFPC	0420	.315	.328	.312	.311	.312	.750	.300
	.313-18 (5/16-18)	NFPA	NFPC	0518	.365	.380	.375	.374	.375	.950	.345

All dimensions are in millimeters.

METRIC	Thread Size x Pitch	Type		Thread Code	A Max.	Min. Material Thickness	Hole Size in Material + 0.08	C Max.	E Nom.	Min. Boss Dia.	Min. Depth Full Thread H <sup>(1)</sup>
		Aluminum	Stainless Steel								
	M2.5 x 0.45	NFPA	NFPC	M2.5	5.84	6.1	4.75	4.72	4.75	12.7	5.38
	M3 x 0.5	NFPA	NFPC	M3	5.84	6.1	4.75	4.72	4.75	12.7	5.38
	M3.5 x 0.6	NFPA	NFPC	M3.5	5.84	6.1	4.75	4.72	4.75	12.7	5.38
	M4 x 0.7	NFPA	NFPC	M4	6.73	6.99	6.35	6.32	6.35	15.88	6.3
	M5 x 0.8	NFPA	NFPC	M5	6.73	6.99	6.35	6.32	6.35	15.88	6.3
	M6 x 1	NFPA	NFPC	M6	8	8.33	7.92	7.89	7.92	19.05	7.62
	M8 x 1.25	NFPA	NFPC	M8	9.27	9.65	9.53	9.50	9.53	24.13	8.76

(1) Thread tapped thru, Class 3A/4h screw must pass with finger torque, but basic go gauge may stop at pilot end.

## PRESS-IN INSERTS

### Thru-Threaded, PPA™ and PPB™ Inserts

- Press-fit insert with strong, reusable threads.
- No heat or ultrasonics required.
- Slotted insert compresses allowing easy access into the mounting hole.
- Aluminum inserts ideal for light weight designs.
- Aluminum inserts offer lead-free alternative.

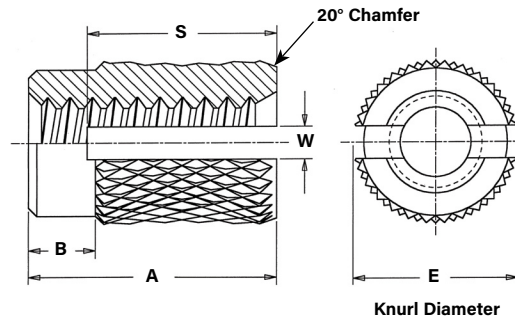
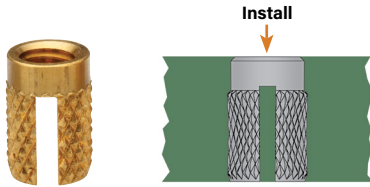

All dimensions are in inches.

UNIFIED	Thread Size	Type		Thread Code (1)	Length Code	A ± .005	E Nom.	B ± .015	S Nom.	W ± .015	Hole Size in Material	
		Aluminum	Brass								Min. Hole Depth	Hole Dia. ± .002
	.086-56 (#2-56)	PPA	PPB	256	1	.156	.134	.040	.115	.020	.196	.125
.112-40 (#4-40)	PPA	PPB	440	1	.188	.169	.045	.140	.020	.228	.156	
				2	.250		.060	.190		.290		
.138-32 (#6-32)	PPA	PPB	632	1	.250	.200	.060	.190	.031	.290	.188	
				2	.313		.075	.235		.353		
.164-32 (#8-32)	PPA	PPB	832	1	.250	.231	.060	.190	.047	.290	.219	
				2	.313		.075	.235		.353		
.190-32 (#10-32)	PPA	PPB	032	1	.313	.263	.075	.235	.062	.353	.250	
				2	.375		.090	.280		.415		
.250-20 (1/4-20)	PPA	PPB	0420	1	.438	.332	.105	.330	.078	.478	.313	
				2	.500		.120	.375		.540		

All dimensions are in millimeters.

METRIC	Thread Size x Pitch	Type		Thread Code (1)	Length Code	A ± 0.13	E Nom.	B ± 0.4	S Nom.	W ± 0.4	Hole Size in Material	
		Aluminum	Brass								Min. Hole Depth	Hole Dia. ± 0.05
	M3 x 0.5	PPA	PPB	M3	1	4.77	4.29	1.14	3.56	0.5	5.79	3.96
2					6.35	1.52		4.83	7.37			
M4 x 0.7	PPA	PPB	M4	1	6.35	5.87	1.52	4.83	1.2	7.37	5.56	
				2	7.95		1.91	5.97		8.97		
M5 x 0.8	PPA	PPB	M5	1	7.95	6.68	1.91	5.97	1.6	8.97	6.35	
				2	9.52		2.29	7.11		10.54		
M6 x 1	PPA	PPB	M6	1	11.12	8.43	2.67	8.38	2	12.14	7.95	
				2	12.7		3.05	9.53		13.72		

(1) Collapsed slot and burrs may cause prevailing torque while thread accepts class 3A/4h screw.

## PRESS-IN INSERTS

### Flange-Head, PFLA™ and PFLB™ Inserts

- Press-fit insert with strong, reusable threads. No heat or ultrasonics required.
- Flange-head eliminates direct contact of plastic with mating parts.
- Slotted insert compresses allowing easy access into the mounting hole.
- Aluminum inserts ideal for light weight designs.
- Aluminum inserts offer lead-free alternative.

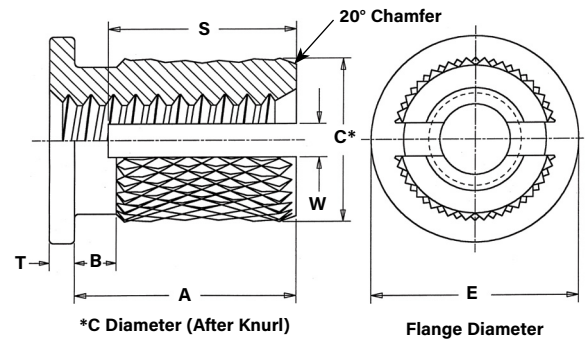
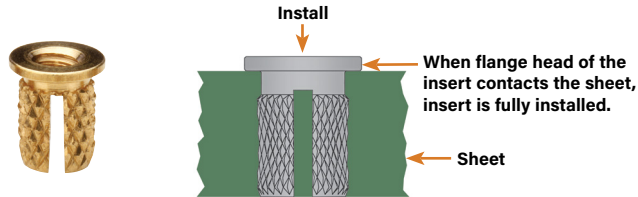

All dimensions are in inches.

UNIFIED	Thread Size	Type		Thread Code (1)	Length Code	A ± .005	E Nom.	C Nom.	T ± .005	B ± .010	S Nom.	W ± .015	Hole Size in Material	
		Aluminum	Brass										Min. Hole Depth	Hole Dia. ± .002
	.086-56 (#2-56)	PFLA	PFLB	256	1	.136	.188	.135	.020	.025	.115	.020	.176	.125
.112-40 (#4-40)	PFLA	PFLB	440	1	.166	.219	.166	.022	.027	.140	.020	.206	.156	
				2	.228							.190		.268
.138-32 (#6-32)	PFLA	PFLB	632	1	.222	.250	.200	.028	.033	.190	.031	.262	.188	
				2	.253							.210		.293
.164-32 (#8-32)	PFLA	PFLB	832	1	.246	.281	.230	.035	.040	.210	.047	.286	.219	
				2	.278							.235		.318
.190-32 (#10-32)	PFLA	PFLB	032	1	.270	.313	.262	.043	.048	.235	.062	.310	.250	
				2	.332							.280		.372
.250-20 (1/4-20)	PFLA	PFLB	0420	1	.388	.375	.335	.050	.055	.330	.078	.428	.313	
				2	.450							.375		.490

All dimensions are in millimeters.

METRIC	Thread Size x Pitch	Type		Thread Code (1)	Length Code	A ± 0.13	E Nom.	C Nom.	T ± 0.13	B ± 0.25	S Nom.	W ± 0.4	Hole Size in Material	
		Aluminum	Brass										Min. Hole Depth	Hole Dia. ± 0.05
	M3 x 0.5	PFLA	PFLB	M3	1	4.22	5.56	4.22	0.56	0.69	3.56	0.5	5.24	3.96
2					5.8	4.83							6.82	
M4 x 0.7	PFLA	PFLB	M4	1	6.25	7.14	5.84	0.89	1.02	5.33	1.14	7.27	5.56	
				2	7.06							5.97		8.08
M5 x 0.8	PFLA	PFLB	M5	1	6.86	7.95	6.65	1.09	1.22	5.97	1.6	7.88	6.35	
				2	8.43							7.11		9.45
M6 x 1	PFLA	PFLB	M6	1	9.86	9.53	8.51	1.27	1.40	8.38	2	10.88	7.95	
				2	11.43							9.53		12.45

(1) Collapsed slot and burrs may cause prevailing torque while thread accepts class 3A/4h screw.

## PRESS-IN INSERTS

### Straight Knurl, PKA™ and PKB™ Inserts

- Press-fit insert with strong, reusable threads. No heat or ultrasonics required.
- Straight knurls at the top end of the insert offers higher torsional resistance.
- Slotted insert compresses allowing easy access into the mounting hole.
- Aluminum inserts ideal for light weight designs.
- Aluminum inserts offer lead-free alternative.

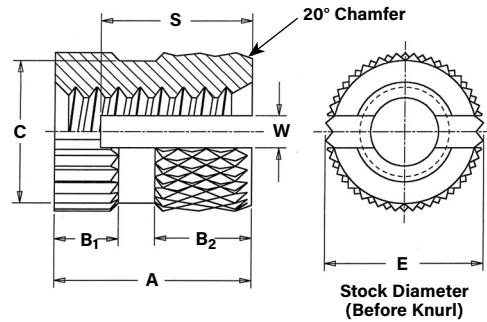
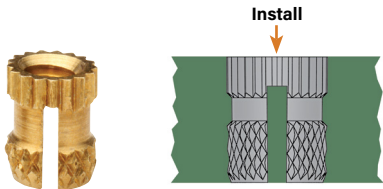

All dimensions are in inches.

UNIFIED	Thread Size	Type		Thread Code (1)	A ± .005	E Nom.	C ± .010	B <sub>1</sub> ± .010	B <sub>2</sub> ± .010	S Nom.	W ± .015	Hole Size in Material	
		Aluminum	Brass									Min. Hole Depth	Hole Dia. ± .002
	.086-56 (#2-56)	PKA	PKB	256	.125	.125	.110	.037	.053	.095	.020	.165	.125
.112-40 (#4-40)	PKA	PKB	440	.188	.156	.137	.056	.079	.140	.020	.228	.156	
.138-32 (#6-32)	PKA	PKB	632	.250	.188	.165	.075	.105	.190	.031	.290	.188	
.164-32 (#8-32)	PKA	PKB	832	.312	.219	.196	.094	.131	.235	.047	.352	.219	
.190-32 (#10-32)	PKA	PKB	032	.375	.250	.234	.112	.158	.280	.062	.415	.250	
.250-20 (1/4-20)	PKA	PKB	0420	.500	.312	.291	.150	.210	.375	.078	.540	.312	

All dimensions are in millimeters.

METRIC	Thread Size x Pitch	Type		Thread Code (1)	A ± 0.13	E Nom.	C ± 0.25	B <sub>1</sub> ± 0.25	B <sub>2</sub> ± 0.25	S Nom.	W ± 0.4	Hole Size in Material	
		Aluminum	Brass									Min. Hole Depth	Hole Dia. ± 0.05
	M3 x 0.5	PKA	PKB	M3	4.78	3.96	3.48	1.42	2.01	3.56	0.5	5.8	3.96
M4 x 0.7	PKA	PKB	M4	7.92	5.56	4.98	2.39	3.33	5.97	1.19	8.94	5.56	
M5 x 0.8	PKA	PKB	M5	9.53	6.35	5.94	2.84	4.01	7.11	1.57	10.55	6.35	
M6 x 1	PKA	PKB	M6	12.7	7.92	7.39	3.81	5.33	9.53	1.98	13.72	7.92	

(1) Collapsed slot and burrs may cause prevailing torque while thread accepts class 3A/4h screw.

## PERFORMANCE DATA FOR PRESS-IN INSERTS

### NFPA and NFPC Inserts(1)

UNIFIED	Thread Code	ABS			Polycarbonate		
		Install. Force (lbs.)	Pullout (lbs.)	Torque-out (in. lbs.)	Install. Force (lbs.)	Pullout (lbs.)	Torque-out (in. lbs.)
	440	225	125	4	600	280	16
	632	225	125	4	600	280	16
	832	300	135	10	600	380	42
	032	300	135	10	600	380	42
	0420	400	235	28	-	-	-

METRIC	Thread Code	ABS			Polycarbonate		
		Install. Force (kN)	Pullout (N)	Torque-out (N · m)	Install. Force (kN)	Pullout (N)	Torque-out (N · m)
	M3	1	556	0.45	2.67	1245	1.8
	M4	1.33	600	1.13	2.67	1690	4.74
	M5	1.33	600	1.13	2.67	1690	4.74
	M6	1.78	1045	3.16	-	-	-

### PPA and PPB Inserts(1)

UNIFIED	Thread Code	Length Code	Phenolic		Polycarbonate	
			Pullout (lbs.)	Torque-out (in. lbs.)	Pullout (lbs.)	Torque-out (in. lbs.)
	256	1	60	12.8	52	7.2
	440	1	81	20.8	74	15.3
		2	193	38.6	170	25.2
	632	1	104	29.2	94	23.4
		2	221	49.6	198	35.6
	832	1	126	36.8	116	31.6
		2	249	59.8	224	45.6
	032	1	147	45.0	138	39.6
		2	276	69.6	253	55.6
	0420	1	192	61.6	182	56.0
		2	334	91.2	308	76.6

METRIC	Thread Code	Length Code	Phenolic		Polycarbonate	
			Pullout (N)	Torque-out (N · m)	Pullout (N)	Torque-out (N · m)
	M3	1	360	2.35	330	1.73
		2	860	4.36	760	2.85
	M4	1	560	4.16	520	3.57
		2	1110	6.76	1000	5.15
	M5	1	650	5.09	610	4.47
		2	1230	7.86	1130	6.28
	M6	1	850	6.96	810	6.33
		2	1490	10.31	1370	8.66

### PFLA and PFLB Inserts(1)

UNIFIED	Thread Code	Length Code	Phenolic		Polycarbonate	
			Pullout (lbs.)	Torque-out (in. lbs.)	Pullout (lbs.)	Torque-out (in. lbs.)
	256	1	28	8.0	17	8.0
	440	1	40	14.7	28	14.7
		2	64	14.7	44	14.7
	632	1	53	22.0	41	22.0
		2	77	22.0	56	22.0
	832	1	64	28.8	53	28.8
		2	72	28.8	68	28.8
	032	1	76	35.6	65	35.6
		2	100	35.6	80	35.6
	0420	1	100	49.8	89	49.8
		2	125	49.8	104	49.8

METRIC	Thread Code	Length Code	Phenolic		Polycarbonate	
			Pullout (N)	Torque-out (N · m)	Pullout (N)	Torque-out (N · m)
	M3	1	180	1.66	130	1.66
		2	280	1.66	200	1.66
	M4	1	280	3.25	240	3.25
		2	320	3.25	300	3.25
	M5	1	340	4.02	290	4.02
		2	450	4.02	360	4.02
	M6	1	450	5.63	400	5.63
		2	560	5.63	460	5.63

### PKA and PKB Inserts(1)

UNIFIED	Thread Code	Phenolic		Polycarbonate	
		Pullout (lbs.)	Torque-out (in. lbs.)	Pullout (lbs.)	Torque-out (in. lbs.)
	256	22	13.2	11	5.2
	440	42	22.2	32	14.4
	632	64	32.6	53	24.6
	832	84	42.0	73	33.8
	032	106	51.2	94	43.0
	0420	149	71.0	136	62.0

METRIC	Thread Code	Phenolic		Polycarbonate	
		Pullout (N)	Torque-out (N · m)	Pullout (N)	Torque-out (N · m)
	M3	190	2.51	140	1.63
	M4	370	4.75	320	3.82
	M5	470	5.79	420	4.86
	M6	660	8.02	610	7.01

(1) The values reported are averages when all installation specifications and procedures are followed. Variations in mounting hole size, work piece material and installation procedure will affect results. Performance testing of this product in your application is recommended. Samples can be provided for this purpose.

# SI® INSERTS FOR PLASTICS

If necessary our applications engineering department can assist you to design a custom component to satisfy your requirements. Below are a few examples.

## THIN SHEET STUDS

Provide external threads in material as thin as .125" / 3.175 mm. SI® studs are available in lengths from 1/4" to 3/4" / 6.35 to 19.05 mm in thread sizes #4-40 to 1/4-20 / M3 to M6. These inserts can be provided in aluminum, brass, steel and stainless steel and can be pressed into pre-molded or drilled holes.

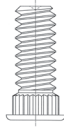

## ULTRASONIC STUDS

Tapered body provides easy insertion in pre-molded or drilled holes. They are available in lengths from 1/4" to 3/4" / 6.35 to 19.05 mm in thread sizes #2-56 to 1/4-20 / M2 to M6. These inserts can be provided in aluminum, brass, steel and stainless steel.



## SELF-LOCKING ULTRASONIC INSERTS

The self-locking feature prevents screw loosening and is advantageous in applications where vibration is present. They are available in thread sizes #2-56 to 1/4-20 / M2 to M6 and are designed for ultrasonic installation into straight or tapered holes.

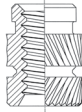

## PRESS-IN STUDS

Allows for mounting a component on external threads. Available in lengths from 3/16" to 1" / 4.76 to 25.4 mm. Thread sizes #4-40 to 1/4-20 / M3 to M6. SI® press-in studs are available in aluminum, brass, steel and stainless steel and can be installed into pre-molded or drilled holes without the use of heat or ultrasonics.



## PEM® VARIMOUNT® BONDING FASTENERS

- Laminate within composite layers.
- Mold into plastics.
- Surface bond to panels from front or back side.
- Available with studs, nuts, or standoffs to meet a variety of applications.

For more information, see [PEM® Bulletin VM.](#)



### HOLE PREPARATION GUIDELINES

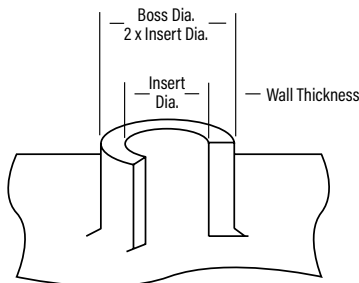

Thinner walls and bosses may be used but will affect performance.

### PULLOUT

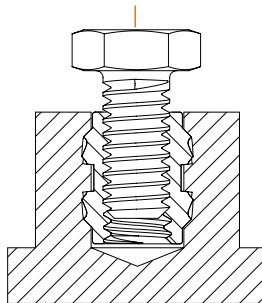

**Pullout** is the force required to pull the insert from the sheet.

### TORQUE OUT

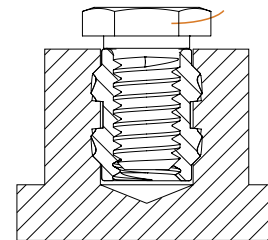

**Torque-out** is the torque required to turn the fastener in the parent material after installation without inducing clamp load on the fastener.

## Proper installation for SI® brand inserts

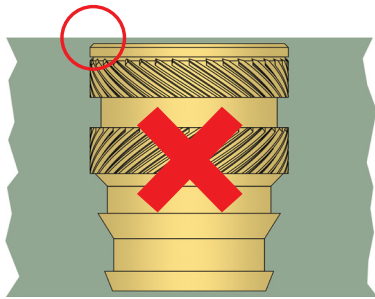

### Incorrect

Inserts installed below the surface of the host plastic will be subjected to jack-out.

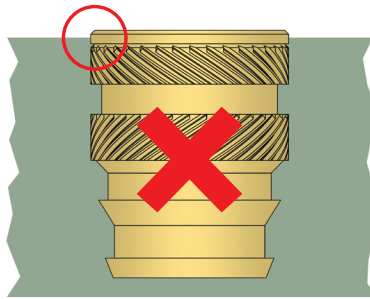

### Incorrect

Inserts installed above the surface of the host plastic will not achieve optimal effectiveness.

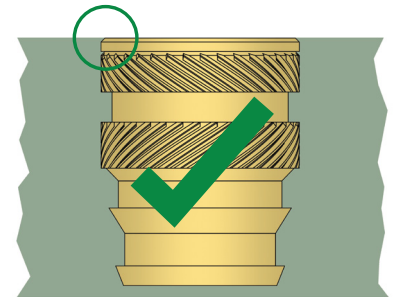

### Correct

Inserts should be installed flush or within .005" above the host plastic for the best performance.

## Mating Component

To prevent jack-out, it is very important that the clearance hole of the mating component is sized correctly. The clearance hole should be larger than the assembly screw, yet smaller than the outside diameter of the insert so that the insert, not the host plastic, carries the compressive load. If the clearance hole must be oversized for misalignment purposes, a headed insert is recommended to increase the insert bearing area surface.

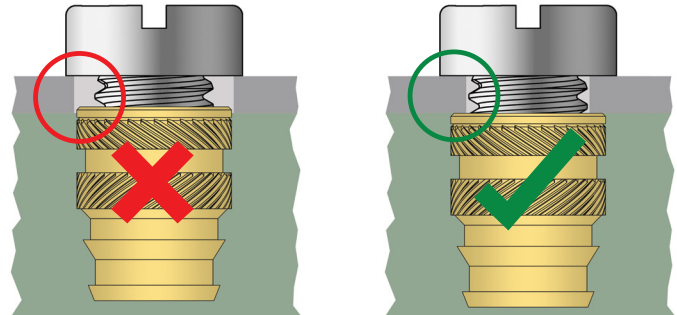

The diameter of the clearance hole in the mating component is very important. The insert and not the plastic must carry the load. The hole in the mating component must be larger than the outside diameter of the assembly screw, but smaller than the pilot or face diameter of the insert. This prevents jack-out. If a larger hole in the mating component is required for alignment purposes, a headed insert should be considered. Inserts should be installed flush (or no more than 0.13 mm (.005") above the hole).

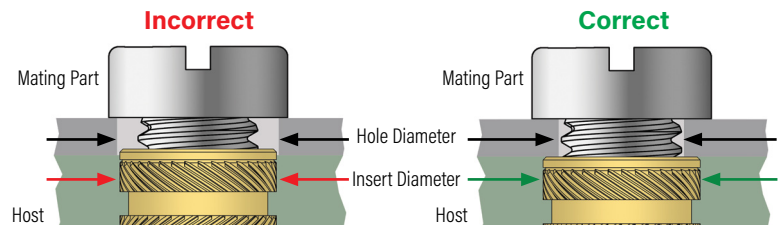

Hole in mating part must be smaller than insert diameter in host to prevent the insert from pulling through the assembly – known as "jack-out."

All specifications in this bulletin are presented as accurately and up-to-date as possible. We reserve the right to make changes to any information contained in this bulletin without notice.

We recommend that you test a particular product to be sure it is ideally suited to your application. We will be happy to provide samples for this purpose and our authorized distributors can also help you with your selection.

All PEM® products meet our stringent quality standards. If you require additional industry or other specific [quality certifications](#), special procedures and/or part numbers are required. Please contact your local sales office or representative for further information.

Regulatory [compliance information](#) is available in Technical Support section of our website. Specifications subject to change without notice. See our website for the most current version of this bulletin.

**PennEngineering®**



**North America:** Danboro, Pennsylvania USA ■ E-mail: [info@pemnet.com](mailto:info@pemnet.com) ■ Tel: +1-215-766-8853 ■ 800-237-4736 (USA)

**Europe:** Galway, Ireland ■ E-mail: [europa@pemnet.com](mailto:europa@pemnet.com) ■ Tel: +353-91-751714

**Asia/Pacific:** Singapore ■ E-mail: [singapore@pemnet.com](mailto:singapore@pemnet.com) ■ Tel: +65-6-745-0660

Shanghai, China ■ E-mail: [china@pemnet.com](mailto:china@pemnet.com) ■ Tel: +86-21-5868-3688

Visit our PEMNET™ Resource Center at [www.pemnet.com](http://www.pemnet.com) ■ Technical support e-mail: [techsupport@pemnet.com](mailto:techsupport@pemnet.com)



# Mouser Electronics

Authorized Distributor

Click to View Pricing, Inventory, Delivery & Lifecycle Information:

SI:

[IUTC-M5](#) [IUTC-M6](#) [IUTC-832](#) [IUTC-M2](#) [IUTC-M2.5](#) [IUTC-M3](#) [IUTC-M3.5](#) [IUTC-M4](#) [IUTC-0420](#) [IUTC-0428](#)  
[IUTC-0616](#) [IUTC-256](#) [IUTC-440](#) [IUTC-632](#) [IUTB-M3.5](#) [IUTB-M4](#) [IUTB-M5](#) [IUTB-M6](#) [IUTC-024](#) [IUTC-032](#) [IUTB-](#)  
[440](#) [IUTB-632](#) [IUTB-832](#) [IUTB-M2](#) [IUTB-M2.5](#) [IUTB-M3](#) [IUTB-024](#) [IUTB-032](#) [IUTB-0420](#) [IUTB-0428](#) [IUTB-0616](#)  
[IUTB-256](#) [IUTA-M2.5](#) [IUTA-M3](#) [IUTA-M3.5](#) [IUTA-M4](#) [IUTA-M5](#) [IUTA-M6](#) [IUTA-0616](#) [IUTA-256](#) [IUTA-440](#) [IUTA-](#)  
[632](#) [IUTA-832](#) [IUTA-M2](#) [IUC-M8-1](#) [IUC-M8-2](#) [IUTA-024](#) [IUTA-032](#) [IUTA-0420](#) [IUTA-0428](#) [IUC-M4-1](#) [IUC-M4-2](#)  
[IUC-M5-1](#) [IUC-M5-2](#) [IUC-M6-1](#) [IUC-M6-2](#) [IUC-M2.5-1](#) [IUC-M2.5-2](#) [IUC-M3.5-1](#) [IUC-M3.5-2](#) [IUC-M3-1](#) [IUC-M3-2](#)  
[IUC-832-1](#) [IUC-832-2](#) [IUCC-M3-1](#) [IUCC-M3-2](#) [IUCC-M5-1](#) [IUCC-M5-2](#) [IUC-256-1](#) [IUC-256-2](#) [IUC-440-1](#) [IUC-440-2](#)  
[IUC-632-1](#) [IUC-632-2](#) [IUC-0518-1](#) [IUC-0518-2](#) [IUC-0616-1](#) [IUC-0616-2](#) [IUC-080-1](#) [IUC-080-2](#) [IUC-032-1](#) [IUC-](#)  
[032-2](#) [IUC-0420-1](#) [IUC-0420-2](#) [IUC-0428-1](#) [IUC-0428-2](#) [IUB-M6-1](#) [IUB-M6-2](#) [IUB-M8-1](#) [IUB-M8-2](#) [IUC-024-1](#) [IUC-](#)  
[024-2](#) [IUB-M3-1](#) [IUB-M3-2](#) [IUB-M4-1](#) [IUB-M4-2](#) [IUB-M5-1](#) [IUB-M5-2](#) [IUBB-M5-1](#) [IUBB-M5-2](#)