

Standard range - 10Vdc to 12kVdc

ProtectiCap™ capacitors

TCC/VCC capacitors

VC1 capacitors

PSL capacitors

High Q capacitors - MS range

Ultra-low ESR capacitors

StackiCap™ capacitors

Non-magnetic capacitors

X8R High Temperature capacitors

Open Mode and Tandem capacitors

IECO-CECC & AEC-Q200 ranges

S02A Space grade ranges

Safety Certified capacitors

250Vac Non Safety rated AC capacitors

115Vac 400Hz capable capacitors

High Dielectric Withstand Voltage ranges

E01 & E07 feedthrough chip capacitors

X2Y Integrated Passive Components

Radial Leaded capacitors

MLC Capacitors



www.syfer.com

Introduction to Syfer Technology

First in the market with flexible polymer terminations

- the revolutionary FlexiCap™ capacitors - our capacitor range also includes: ProtectiCap™, high voltage capacitors, X8R high temperature types, High Q capacitors and other application specific types. Our renowned high voltage MLCC expertise has led to the development of an impressive range with working voltage capability up to 12kV. This includes surface mount Class 'X' and 'Y' approved Safety Certified capacitors, 0603 chips with working voltages up to 500V and 0805 types up to 2kV.

We are able to offer unrivalled product quality with short lead-times, backed up by excellent sales and technical support. With a commitment to product innovation, new ranges are continually being developed.

Our experienced applications engineers are also available to provide custom solutions for specific applications. This catalogue details the standard ranges but we can provide items such as tight tolerance, low profile and non standard sizes on request. Flexibility is key, not only in design but in all aspects of customer service and support.

Our quality management systems meet international requirements, with approval to ISO 9001, environmental approval to ISO 14001 and Occupational Health and Safety approval to OHSAS 18001. Product approvals include, IECQ-CECC, UL, TÜV and qualification to AEC-Q200. SPC is used extensively, supported by Continuous Improvement Programmes, 6 Sigma projects and Lean Manufacturing initiatives.

Products

Syfer's excellence in ceramic materials technology, has enabled us to offer an unrivalled range of multilayer ceramic products including:

- Multilayer ceramic chip capacitors
- High voltage MLCCs
- ProtectiCap™ capacitors
- FlexiCap™ capacitors with flexible terminations
- StackiCap™ capacitors
- Class 'X' and 'Y' SMD Safety Certified capacitors
- Radial leaded capacitors
- AEC-Q200 qualified capacitors
- IECQ CECC approved capacitors
- Capacitors for space applications
- High Q capacitors
- Non-magnetic capacitors
- 3 terminal EMI chips
- X2Y Integrated Passive Components

Benefits

- High quality and reliability
- World-leading high voltage expertise
- Suitable for the most demanding applications including: automotive, aerospace, military, space and medical
- Approvals to international specifications
- Continual product improvement and innovation
- Tight tolerances available
- Large case sizes, up to 8060
- Custom product capability
- Strong technical support
- Short lead-times
- Environmentally responsible

Suffix code controlled items such as Low profile, defined thickness and custom lead forms available by special request.

Other Syfer products

- Surface mount Pi filters
- Panel mount threaded filters
- Panel mount solder-in filters
- Custom filter assembly capability
- Varistor filters
- Discoidal capacitors
- Planar capacitor and planar varistor arrays
- EMI Power Filters
- Hermetically sealed EMI filters



www.syfer.com

MLCC standard range - 10V to 12kVdc

Notes: 1) Capacitance in F - min value above max value. 2) *These parts may require conformal coating post soldering. 3) T = Maximum thickness. 4) †Higher capacitance values

	10V		16V			25V			50/63V			100V		200/250V		500V		630V		1kV		1.2kV		
	COG/NPO	X5R	COG/NPO	X7R	X5R	COG/NPO	X7R	X5R	COG/NPO	X7R	X5R	COG/NPO	X7R	COG/NPO	X7R	COG/NPO	X7R	COG/NPO	X7R	COG/NPO	X7R	COG/NPO	X7R	
0603	0.47p - 3.9n	120n - 150n	0.47p - 2.7n	100p - 100n	120n	0.47p - 2.2n	100p - 100n	—	0.47p - 1.5n	100p - 47n	56n - 68n	0.47p - 470p	100p - 33n	0.47p - 220p	100p - 10n	0.47p - 150p*	100p - 1.5n*	—	—	—	—	—	—	—
0805	1.0p - 15n	390n - 680n	1.0p - 12n	100p - 330n	390n - 470n	1.0p - 10n	100p - 220n	270n - 390n	1.0p - 5.6n	100p - 220n	270n - 330n	1.0p - 2.2n	100p - 100n	1.0p - 1n	100p - 56n	1.0p - 680p	100p - 15n	1.0p - 560p	100p - 12n	1.0p - 180p	100p - 10n	1.0p - 120p	—	—
1206	1.0p - 47n	1.2μ - 1.5μ	1.0p - 33n	100p - 1.0μ	1.2μ	1.0p - 27n	100p - 820n	1.0μ	1.0p - 22n	100p - 470n	560n - 680n	1.0p - 8.2n	100p - 330n	1.0p - 3.3n	100p - 150n	1.0p - 2.2n	100p - 68n	1.0p - 1.5n	100p - 47n	1.0p - 1.0n	100p - 27n	1.0p - 680p	1.0p - 15n	100p - 15n
1210	3.9p - 100n	1.8μ - 3.3μ	3.9p - 68n	100p - 1.5μ	1.8μ - 2.7μ	3.9p - 56n	100p - 1.2μ	1.5μ - 2.2μ	3.9p - 33n	100p - 1.0μ	1.2μ - 1.5μ	3.9p - 18n	100p - 680n	3.9p - 8.2n	100p - 330n	3.9p - 6.8n	100p - 150n	3.9p - 3.9n	100p - 100n	3.9p - 2.2n	100p - 47n	3.9p - 1.5n	100p - 18n	100p - 18n
1808	4.7p - 100n	1.8μ - 2.7μ	4.7p - 68n	100p - 1.5μ	1.8μ - 2.2μ	4.7p - 47n	100p - 1.2μ	1.5μ	4.7p - 33n	100p - 680n	820n - 1.0μ	4.7p - 18n	100p - 560n	4.7p - 8.2n	100p - 270n	4.7p - 5.6n	100p - 150n	4.7p - 3.9n	100p - 100n	4.7p - 2.2n	100p - 47n	4.7p - 1.5n	100p - 22n	100p - 22n
1812 T=2.5mm	10p - 220n	3.9μ - 10μ	10p - 180n	150p - 3.3μ	3.9μ - 6.8μ	10p - 150n	150p - 2.2μ	2.7μ - 4.7μ	10p - 100n	150p - 2.2μ	2.7μ - 3.3μ	10p - 47n	150p - 1.5μ	10p - 22n	150p - 680n	10p - 15n	150p - 330n	10p - 10n	150p - 180n	10p - 6.8n	150p - 100n	10p - 4.7n	150p - 33n	150p - 33n
1812 T=3.2mm	—	—	—	—	—	—	—	—	—	—	—	—	—	27n	1000n	18n - 22n	470n	12n	330n	8.2n	180n	5.6n - 6.8n	—	—
1825 T=2.5mm	10p - 470n	5.6μ - 15μ	10p - 330n	220p - 4.7μ	5.6μ - 12μ	10p - 220n	220p - 3.9μ	4.7μ - 10μ	10p - 150n	220p - 1.8μ	2.2μ - 6.8μ	10p - 68n	220p - 1.5μ	10p - 33n	220p - 1.0μ	10p - 27n	220p - 560n	10p - 22n	220p - 180n	10p - 12n	220p - 120n	10p - 6.8n	220p - 68n	220p - 68n
1825 T=3.2mm	—	—	—	—	—	—	—	—	—	—	—	—	—	39n - 47n	—	33n	—	27n	—	15n	—	8.2n - 10n	—	
2220 T=2.5mm	10p - 470n	6.8μ - 18μ	10p - 330n	220p - 5.6μ	6.8μ - 12μ	10p - 220n	220p - 4.7μ	5.6μ - 10μ	10p - 150n	220p - 3.3μ	3.9μ - 6.8μ	10p - 68n	220p - 2.2μ	10p - 33n	220p - 1.0μ	10p - 22n	220p - 560n	10p - 18n	220p - 330n	10p - 15n	220p - 120n	10p - 10n	220p - 82n	220p - 82n
2220 T=4.2mm max.	—	—	—	—	—	—	—	—	—	—	—	—	—	39n - 56n	2200n	27n - 39n	1000n	22n	1000n	18n	470n	12n	15n	2200n
2225 T=2.5mm	10p - 560n	8.2μ - 22μ	10p - 470n	330p - 6.8μ	8.2μ - 15μ	10p - 330n	330p - 5.6μ	6.8μ - 12μ	10p - 220n	330p - 3.3μ	3.9μ - 10μ	10p - 82n	330p - 2.7μ	10p - 47n	330p - 1.5μ	10p - 33n	330p - 820n	10p - 22n	330p - 390n	10p - 18n	330p - 150n	10p - 12n	330p - 100n	330p - 100n
2225 T=4.0mm	—	—	—	—	—	—	—	—	—	—	—	—	—	56n - 68n	—	39n - 47n	—	27n - 39n	—	22n - 27n	—	15n - 22n	—	
3640 T=2.5mm	—	—	—	—	—	—	—	—	10p - 330n	470p - 10μ	—	10p - 270n	470p - 5.6μ	10p - 120n	470p - 3.3μ	10p - 82n	470p - 1.0μ	10p - 68n	470p - 680n	10p - 47n	470p - 180n	10p - 33n	470p - 150n	
3640 T=4.0mm	—	—	—	—	—	—	—	—	—	—	—	—	—	150n - 180n	—	100n - 120n	—	82n - 100n	—	56n - 82n	—	39n - 56n	—	
5550 T=2.5mm	—	—	—	—	—	—	—	—	390p - 680n	1.0n - 15μ	—	390p - 470n	1.0n - 10μ	390p - 270n	1.0n - 5.6μ	390p - 180n	1.0n - 1.8μ	390p - 120n	1.0n - 1.2μ	390p - 82n	1.0n - 390n	1.0n - 68n	1.0n - 220n	
5550 T=4.0mm	—	—	—	—	—	—	—	—	—	—	—	—	—	330n	—	220n - 270n	—	150n - 180n	—	100n - 150n	—	82n - 100n	—	
8060 T=2.5mm	—	—	—	—	—	—	—	—	680p - 1.0μ	2.2n - 22μ	—	680p - 680n	2.2n - 15μ	680p - 390n	2.2n - 10μ	680p - 270n	2.2n - 3.3μ	680p - 220n	2.2n - 2.2μ	680p - 150n	2.2n - 1.0μ	680p - 100n	2.2n - 470n	
8060 T=4.0mm	—	—	—	—	—	—	—	—	—	—	—	—	—	470n - 560n	—	330n - 470n	—	270n - 390n	—	180n - 270n	—	120n - 180n	—	



Note: 0402, 0505, 1111 and 2211 case sizes are available in our speciality ranges.

Please refer to the relevant sections of this catalogue for more details.

Contents

General introduction

Definitions of Ultra-Stable and Stable.....	2
Dielectric characteristics.....	3
Capacitance, Impedance and E.S.R. vs Frequency	4
Ageing, capacitance measurements and tight tolerance capacitors.....	5
Production processes and reliability	6
FlexiCap™ overview.....	7
Testing and termination types	8
Documentation and compliance.....	9
IECQ-CECC and AEC-Q200 periodic tests.....	10
Handling notes.....	11
Soldering information	12
Chip dimensions.....	13
Product Selector.....	14-15



Ceramic Chip capacitors

Standard MLCC ranges - 10Vdc to 12kVdc - C0G/NP0 & X7R	16-18
ProtectiCap™ capacitors	19
TCC/VCC capacitors.....	20-21
VC1 capacitors	22-23
PSL capacitors.....	24-25
High Q capacitors - MS range.....	26-27
Ultra-low ESR capacitors	28
StackiCap™ capacitors.....	29
Non-magnetic capacitors	30-31
Non-magnetic Ribbon Ledged capacitors.....	32
Open Mode & Tandem capacitors	33
IECQ-CECC range.....	34
AEC-Q200 range.....	35
S02A Space grade range.....	36
Safety Certified capacitors.....	37-39
250Vac Non Safety rated AC capacitors.....	40
115Vac 400Hz capacitors	41
High Dielectric Withstand Voltage range.....	42
X8R High Temperature capacitors	43



Surface Mount EMI filters

E01 & E07 feedthrough chip capacitors.....	44-45
E03 X2Y Integrated Passive Components	46-47
Packaging information - Ceramic chip capacitors.....	48-49



Radial Leaded capacitors	50-55
Packaging information - Radial Leaded capacitors.....	56-57

Definitions of Ultra-Stable and Stable

Multilayer Ceramic Capacitors are generally divided into classes which are defined by the capacitance temperature characteristics over specified temperature ranges. These are designated by alpha numeric codes. Code definitions are summarised below and are also available in the relevant national and international specifications.

COG/NPO - Ultra Stable Class 1 Ceramic (EIA Class 1)

Spec.	Classification	Temperature range °C	Maximum capacitance change @ rated DC volts	Syfer dielectric code
CECC	1B/CG	-55 +125	0 ± 30ppm/°C	C
EIA	COG/NPO	-55 +125	0 ± 30ppm/°C	C
MIL	CG (BP)	-55 +125	0 ± 30ppm/°C	C

Capacitors within this class have a dielectric constant range from 10 to 100. They are used in applications which require ultra stable dielectric characteristics with negligible dependence of capacitance and dissipation factor with time, voltage and frequency. They exhibit the following characteristics:-

- Time does not significantly affect capacitance and dissipation factor (Tan δ) – no ageing.
- Capacitance and dissipation factor are not affected by voltage.
- Linear temperature coefficient.

X8R, X7R and X5R - Stable Class II Ceramic (EIA Class II)

Spec.	Classification	Temperature range °C	Maximum capacitance change % over temperature range		Syfer dielectric code
			No DC volt applied	Rated DC Volt	
CECC	2C1	-55 +125	±20	+20 -30	R
	2R1	-55 +125	±15	- -	X
	2X1	-55 +125	±15	+15 -25	B
EIA	X8R	-55 +150	±15	- -	N
	X7R	-55 +125	±15	- -	X
	X5R	-55 +85	±15	- -	P
MIL	BX	-55 +125	±15	+15 -25	B
	BZ	-55 +125	±20	+20 -30	R

Capacitors of this type have a dielectric constant range of 1000-4000 and also have a non-linear temperature characteristic which exhibits a dielectric constant variation of less than ±15% (2R1) from its room temperature value, over the specified temperature range. Generally used for by-passing (decoupling), coupling, filtering, frequency discrimination, DC blocking and voltage transient

suppression with greater volumetric efficiency than Class I units, whilst maintaining stability within defined limits.

Capacitance and dissipation factor are affected by:-

- Time (Ageing)
- Voltage (AC or DC)
- Frequency

Typical dielectric temperature characteristics

COG/NPO capacitance vs temperature

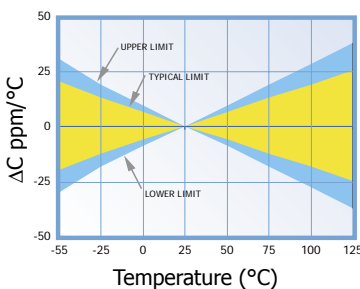

X7R capacitance vs temperature

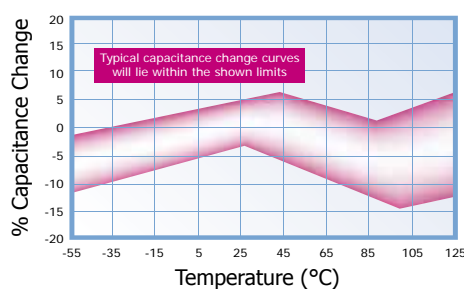

Power ratings

COG/NPO and X7R

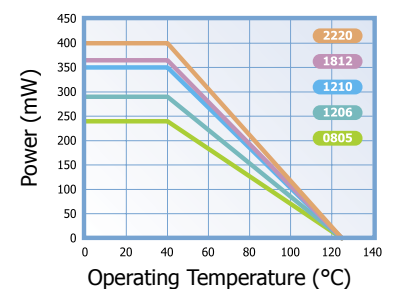

Dielectric characteristics

Technical Summary

	COG/NPO			X5R	X7R			X8R
Dielectric characteristics	Ultra stable			Stable	Stable			Stable
IECQ-CECC	1B/CG	-	-	-	2C1	2R1	2X1	-
EIA	-	COG/NPO	-	X5R	-	X7R	-	X8R
MIL	-	-	CG (BP)	-	BZ	-	BX	-
Rated temperature range	-55°C to +125°C			-55°C to +85°C	-55°C to +125°C			-55°C to +150°C
Maximum capacitance change over temperature range No DC voltage applied	0 ± 30 ppm/°C			± 15%	± 20%	± 15%	± 15%	± 15%
Rated DC voltage applied				-	+20 -30%	-	+15 -25%	-
Syfer dielectric ordering code	C			P	R	X	B	N
Tangent of loss angle (tan δ)	Cr > 50pF ≤ 0.0015 Cr ≤ 50pF = 0.0015 $(\frac{15}{Cr} + 0.7)$			≤ 0.025	≤ 0.025			≤ 0.025
Insulation resistance (Ri) Time constant (Ri x Cr) (whichever is the least)	100G Ω or 1000s			100G Ω or 1000s	100G Ω or 1000s			100G Ω or 1000s
Capacitance tolerance	Cr < 4.7pF	± 0.05pF (H) ± 0.10pF (B) ± 0.25pF (C) ± 0.50pF (D)		± 5% (J) ± 10% (K) ± 20% (M)	± 5% (J) ± 10% (K) ± 20% (M)			± 5% (J) ± 10% (K) ± 20% (M)
	Cr < 10pF	± 0.10pF (B) ± 0.25pF (C) ± 0.50pF (D)						
	Cr ≥ 10pF	± 1% (F) ± 2% (G) ± 5% (J) ± 10% (K)						
Dielectric strength	Voltage applied for 5 seconds. Charging current limited to 50mA maximum.							
≤ 200V	2.5 times			2.5 times	2.5 times			2.5 times
> 200V to < 500V	Rated voltage + 250V			-	Rated voltage + 250V			-
500V to ≤ 1000V	1.5 times			-	-			-
500V to < 1000V	-			-	1.5 times			-
> 1kV to ≤ 1200V	1.25 times			-	-			-
> 1200V	1.2 times			-	-			-
≥ 1000V	-			-	1.2 times			-
Climatic category (IEC)								
Chip	55/125/56			55/85/56	55/125/56			55/150/56
Dipped	55/125/21			-	55/125/21			-
Discoidal	55/125/56			-	55/125/56			-
Ageing characteristic (Typical)	Zero			< 2% per time decade	< 2% per time decade			< 2% per time decade

The table above highlights the difference in coding for IECQ-CECC, EIA and MIL standards when defining the temperature coefficient and the voltage coefficient.

Approvals

Chip	QC-32100	-	QC-32100	-
------	----------	---	----------	---

Capacitance, Impedance and E.S.R. vs Frequency

Impedance vs Frequency - chips

Ultra Stable C0G/NP0 dielectric

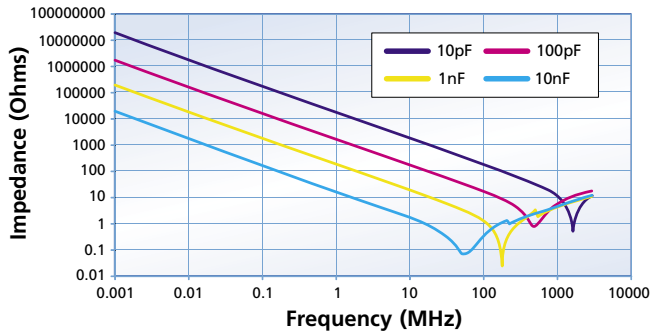

ESR vs Frequency - chips

Ultra Stable C0G/NP0 dielectric

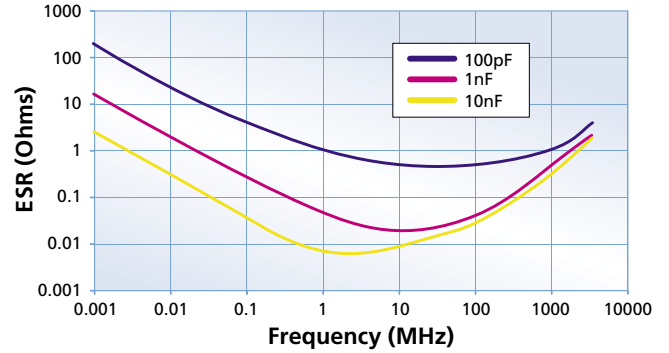

Stable X7R dielectric

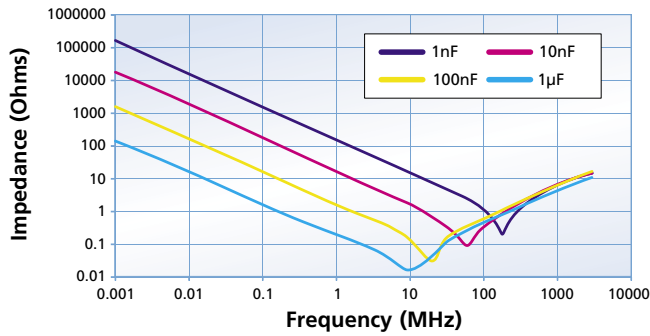

Stable X7R dielectric

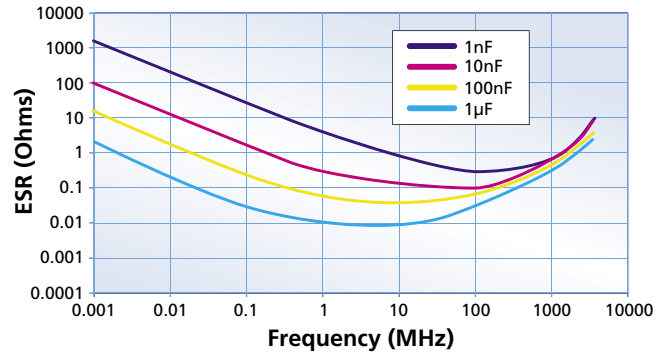

Impedance vs Frequency - 10nF chips

Stable X7R dielectric

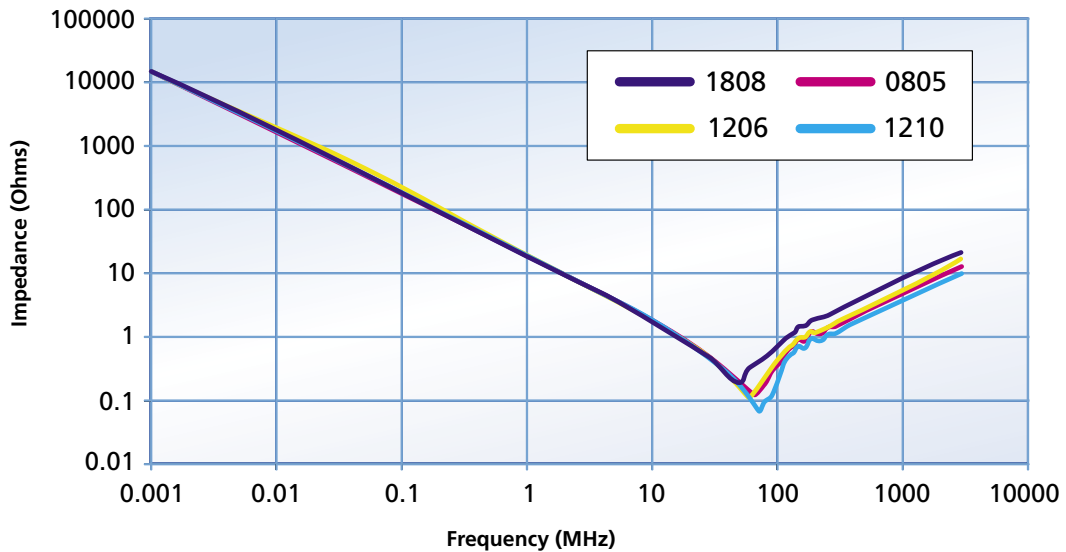

Ageing of ceramic capacitors

Ageing

Capacitor ageing is a term used to describe the negative, logarithmic capacitance change which takes place in ceramic capacitors with time. The crystalline structure for barium titanate based ceramics changes on passing through its Curie temperature (known as the Curie Point) at about 125°C. This domain structure relaxes with time and in doing so, the dielectric constant reduces logarithmically; this is known as the ageing mechanism of the dielectric constant. The more stable dielectrics have the lowest ageing rates.

The ageing process is reversible and repeatable. Whenever the capacitor is heated to a temperature above the Curie Point the ageing process starts again from zero.

The ageing constant, or ageing rate, is defined as the percentage loss of capacitance due to the ageing process of the dielectric which occurs during a decade of time (a tenfold increase in age) and is expressed as percent per logarithmic decade of hours. As the law of decrease of capacitance is logarithmic, this means that in a capacitor with an ageing rate of 1% per decade of time, the capacitance will decrease at a rate of:

- a) 1% between 1 and 10 hours
- b) An additional 1% between the following 10 and 100 hours
- c) An additional 1% between the following 100 and 1000 hours
- d) An additional 1% between the following 1000 and 10000 hours etc
- e) The ageing rate continues in this manner throughout the capacitor's life.

Typical values of the ageing constant for our Multilayer Ceramic Capacitors are:

Dielectric class	Typical values
Ultra Stable COG/NPO	Negligible capacitance loss through ageing
Stable X7R	<2 % per decade of time

Capacitance measurements

Because of ageing it is necessary to specify an age for reference measurements at which the capacitance shall be within the prescribed tolerance. This is fixed at 1000 hours, since for practical purposes there is not much further loss of capacitance after this time.

All capacitors shipped are within their specified tolerance at the standard reference age of 1000 hours after having cooled through their Curie temperature.

The ageing curve for any ceramic dielectric is a straight line when plotted on semi-log paper.

Capacitance vs time

(Ageing X7R @ <2% per decade)

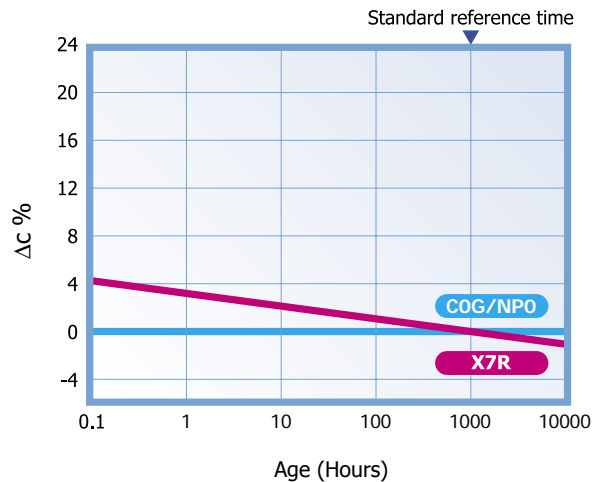

Tight tolerance

One of the advantages of Syfer's unique 'wet process' of manufacture is the ability to offer capacitors with exceptionally tight capacitance tolerances.

The accuracy of the printing screens used in the fully automated, computer controlled manufacturing process allows for tolerance as close as +/-1% on COG/NPO parts greater than or equal to 10pF. For capacitance values below <4.7pF, tolerances can be as tight as +/-0.05pF.

Production processes and reliability

Production process flowchart

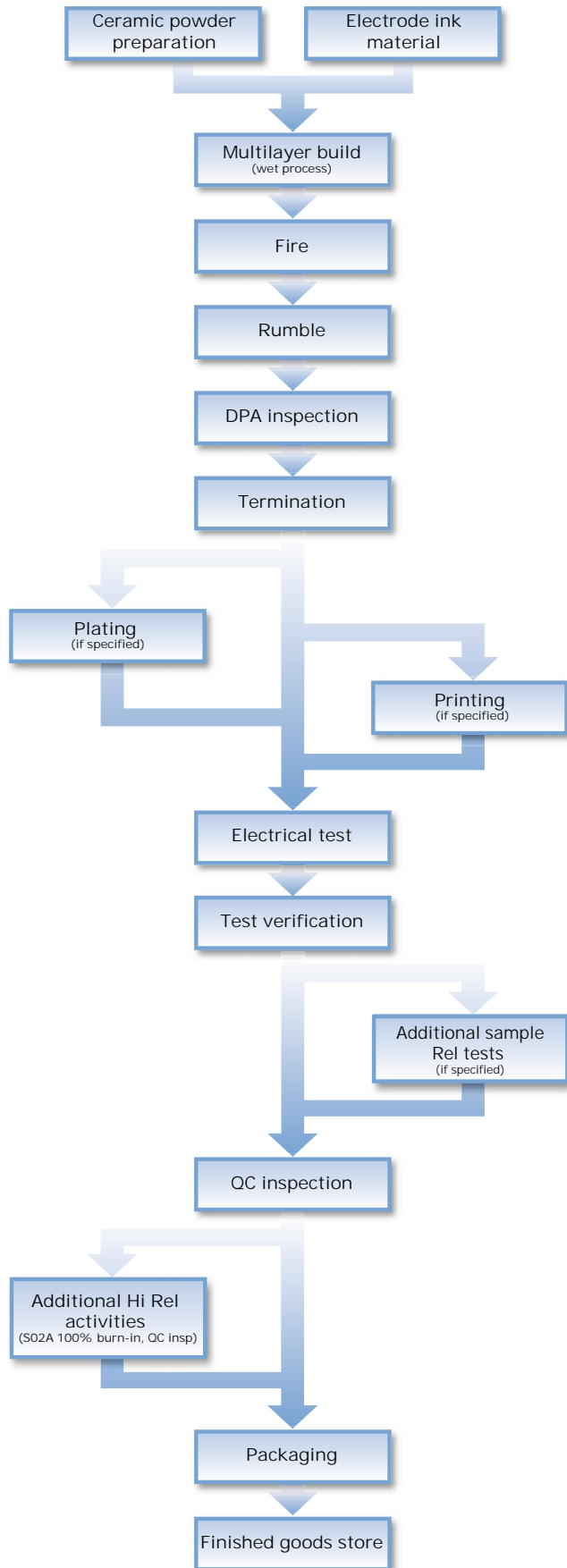

Syfer reliability grades

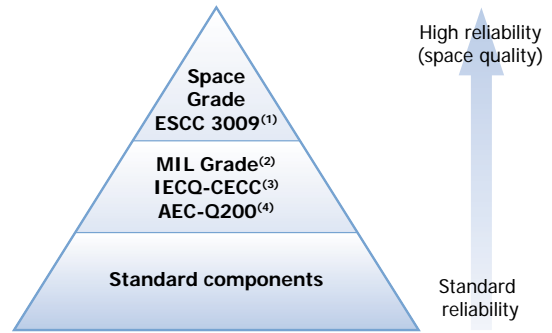

Notes:

- (1) Space grade tested in accordance with ESCC 3009. Refer to Syfer specification S02A 0100.
- (2) MIL Grade. Released in accordance with US standards available on request.
- (3) IECQ-CECC. The International Electrotechnical Commission (IEC) Quality Assessment System for Electronic Components. This is an internationally recognised product quality certification which provides customers with assurance that the product supplied meets high quality standards.
View Syfer's IECQ-CECC approvals at <http://www.iecq.org> or at www.syfer.com
- (4) AEC-Q200. Automotive Electronics Council Stress Test Qualification For Passive Components. Refer to Syfer application note reference AN0009.

Syfer reliability surface mount product groups

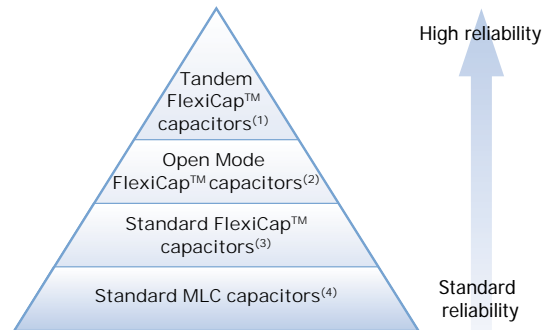

Notes:

- (1) "Tandem" construction capacitors, ie internally having the equivalent of 2 series capacitors. If one of these should fail short-circuit, there is still capacitance end to end and the chip will still function as a capacitor, although capacitance maybe affected. Refer to application note AN0021. Also available qualified to AEC-Q200.
- (2) "Open Mode" capacitors with FlexiCap™ termination also reduce the possibility of a short circuit by utilising inset electrode margins. Refer to application note AN0022. Also available qualified to AEC-Q200.
- (3) Multilayer capacitors with Syfer FlexiCap™ termination. By using FlexiCap™ termination, there is a reduced possibility of the mechanical cracking occurring.
- (4) "Standard" capacitors includes MLCCs with tin finish over nickel, but no FlexiCap™.

FlexiCap™ overview

FlexiCap™ termination

MLCCs are widely used in electronic circuit design for a multitude of applications. Their small package size, technical performance and suitability for automated assembly makes them the component of choice for the specifier.

However, despite the technical benefits, ceramic components are brittle and need careful handling on the production floor. In some circumstances they may be prone to mechanical stress damage if not used in an appropriate manner. Board flexing, depanelisation, mounting through hole components, poor storage and automatic testing may all result in cracking.

Careful process control is important at all stages of circuit board assembly and transportation - from component placement to test and packaging. Any significant board flexing may result in stress fractures in ceramic devices that may not always be evident during the board assembly process. Sometimes it may be the end customer who finds out - when equipment fails!

Syfer has the solution - FlexiCap™

FlexiCap™ has been developed as a result of listening to customers' experiences of stress damage to MLCCs from many manufacturers, often caused by variations in production processes.

Our answer is a proprietary flexible epoxy polymer termination material, that is applied to the device under the usual nickel barrier finish. FlexiCap™ will accommodate a greater degree of board bending than conventional capacitors.

Syfer FlexiCap™ termination

Ranges are available with FlexiCap™ termination material offering increased reliability and superior mechanical performance (board flex and temperature cycling) when compared with standard termination materials. Refer to Syfer application note reference AN0001. FlexiCap™ capacitors enable the board to be bent almost twice as much before mechanical cracking occurs. Refer to application note AN0002.

FlexiCap™ is also suitable for Space applications having passed thermal vacuum outgassing tests. Refer to Syfer application note reference AN0026.

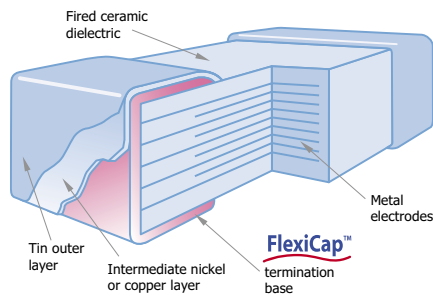

FlexiCap™ MLCC cross section

FlexiCap™ benefits

With traditional termination materials and assembly, the chain of materials from bare PCB to soldered termination, provides no flexibility. In circumstances where excessive stress is applied - the weakest link fails. This means the ceramic itself, which may fail short circuit.

The benefit to the user is to facilitate a wider process window - giving a greater safety margin and substantially reducing the typical root causes of mechanical stress cracking.

FlexiCap™ may be soldered using your traditional wave or reflow solder techniques including lead free and needs no adjustment to equipment or current processes.

Syfer has delivered millions of FlexiCap™ components and during that time has collected substantial test and reliability data, working

in partnership with customers world wide, to eliminate mechanical cracking.

An additional benefit of FlexiCap™ is that MLCCs can withstand temperature cycling -55°C to 125°C in excess of 1,000 times without cracking.

FlexiCap™ termination has no adverse effect on any electrical parameters, nor affects the operation of the MLCC in any way.



● Picture taken at 1,000x magnification using a SEM to demonstrate the fibrous nature of the FlexiCap™ termination that absorbs increased levels of mechanical stress.

Available on the following ranges:

- All High Reliability ranges
- Standard and High Voltage chips
- Safety Certified capacitor chips
- Non-magnetic capacitors
- 3 terminal EMI chips
- X2Y Integrated Passive Components
- X8R High Temperature capacitors

Summary of PCB bend test results

The bend tests conducted on X7R have proven that the FlexiCap™ termination withstands a greater level of mechanical stress before mechanical cracking occurs.

The AEC-Q200 test for X7R requires a bend level of 2mm minimum and a cap change of less than 10%.

Product X7R	Typical bend performance under AEC-Q200 test conditions
Standard termination	2mm to 3mm
FlexiCap™	Typically 8mm to 10mm

Application notes

FlexiCap™ may be handled, stored and transported in the same manner as standard terminated capacitors. The requirements for mounting and soldering FlexiCap™ are the same as for standard SMD capacitors.

For customers currently using standard terminated capacitors there should be no requirement to change the assembly process when converting to FlexiCap™.

Based upon board bend tests in accordance with IEC 60384-1 the amount of board bending required to mechanically crack a FlexiCap™ terminated capacitor is significantly increased compared with standard terminated capacitors.

It must be stressed however, that capacitor users must not assume that the use of FlexiCap™ terminated capacitors will totally eliminate mechanical cracking. Good process controls are still required for this objective to be achieved.



Testing and termination types

Tests conducted during batch manufacture

	Syfer reliability SM product group			
	Standard SM capacitors	IECQ-CECC / MIL grade	AEC-Q200	S (Space grade) High Rel S02A
Solderability	●	●	●	●
Resistance to soldering heat	●	●	●	●
Plating thickness verification (if plated)	●	●	●	●
DPA (Destructive Physical Analysis)	●	●	●	●
Voltage proof test (DWV / Flash)	●	●	●	●
Insulation resistance	●	●	●	●
Capacitance test	●	●	●	●
Dissipation factor test	●	●	●	●
100% visual inspection	○	○	●	●
100% burn-in. (2xRV @125°C for 168 hours)	○	○	○	●
Load sample test @ 125°C	○	○	○	LAT1 & LAT2 (1000 hours)
Humidity sample test. 85°C/85%RH	○	○	○	240 hours
Hot IR sample test	○	○	○	○
Axial pull sample test (MIL-STD-123)	○	○	○	○
Breakdown voltage sample test	○	○	○	○
Deflection (bend) sample test	○	○	○	○
SAM (Scanning Acoustic Microscopy)	○	○	○	○
LAT1 (4 x adhesion, 8 x rapid temp change + LAT2 and LAT3)	-	-	-	○
LAT2 (20 x 1000 hour life test + LAT3)	-	-	-	○
LAT3 (6 x TC and 4 x solderability)	-	-	-	○

- Test conducted as standard.
- Optional test. Please discuss with the sales office.

Termination types available

	Syfer reliability SM product group			
	Standard SM capacitors	IECQ-CECC / MIL grade	AEC-Q200	S (space grade) High Rel S02A
F: Silver palladium	●	●	-	●
J: Silver base with nickel barrier (100% matte tin plating)	●	●	COG/NP0 dielectric only	○
A: Silver base with nickel barrier (tin/lead plating with min 10% lead)	●	●	-	●
Y: FlexiCap™ with nickel barrier (100% matte tin plating)	●	●	●	○
H: FlexiCap™ with nickel barrier (tin/lead plating with min 10% lead)	●	●	-	○
2: Silver base with Non-magnetic Cu Barrier (100% matte tin plating)	● ⁽¹⁾	-	-	-
3: FlexiCap™ with Non-magnetic Cu Barrier (100% matte tin plating)	● ⁽²⁾	-	-	-

Notes:

- (1) Available on COG/NP0 and High Q only.
- (2) Available on all dielectrics.
- Termination available.
- Termination available but generally not requested for space grade components. Please discuss with the sales office.

Documentation and compliance

Release documentation

	Syfer reliability SM product group			
	Standard SM capacitors	IECQ-CECC	AEC-Q200 MIL grade	S (Space grade) High Rel S02A
Certificate of conformance	●	-	●	●
IECQ-CECC Release certificate of conformity	-	●	-	-
Batch electrical test report	○	○	○	Included in data pack
S (space grade) data documentation package	-	-	-	●

- Release documentation supplied as standard.
- Original documentation.

Periodic tests conducted and reliability data availability

Standard Surface Mount capacitors

Components are randomly selected on a sample basis and the following routine tests are conducted:

- Load Test. 1,000 hours @125°C (150°C for X8R). Applied voltage depends on components tested.
- Humidity Test. 168 hours @ 85°C/85%RH.
- Board Deflection (bend test).

Test results are available on request.

Conversion factors

From	To	Operation
FITS	MTBF (hours)	$10^9 \div \text{FITS}$
FITS	MTBF (years)	$10^9 \div (\text{FITS} \times 8760)$

FITS = Failures in 10^9 hours.

MTBF = Mean time between failures.

Example of FIT (Failure In Time) data available:

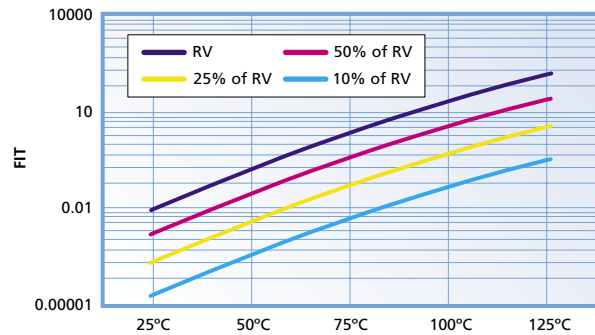

Component type: 0805 (COG/NP0 and X7R).

Testing location: Syfer reliability test department.

Results based on: 16,622,000 component test hours.

REACH (Registration, Evaluation, Authorisation and restriction of Chemicals) statement

The main purpose of REACH is to improve the protection of human health and the environment from the risks arising from the use of chemicals.

Syfer Technology Ltd maintains both ISO14001, Environmental Management System and OHSAS 18001 Health and Safety Management System approvals that require and ensure compliance with corresponding legislation such as REACH.

For further information, please contact the sales office at sales@syfer.co.uk

RoHS compliance

Syfer routinely monitors world wide material restrictions (e.g. EU / China and Korea RoHS mandates) and is actively involved in shaping future legislation.

All standard COG/NP0, X7R, X5R and High Q Syfer MLCC products are compliant with the EU RoHS directive (see below for special

exceptions) and those with plated terminations are suitable for soldering using common lead free solder alloys (refer to 'Soldering Information' for more details on soldering limitations). Compliance with the EU RoHS directive automatically signifies compliance with some other legislation (e.g. Korea RoHS). Please refer to the sales office for details of compliance with other materials legislation.

Breakdown of material content, SGS analysis reports and tin whisker test results are available on request.

Most Syfer MLCC components are available with non RoHS compliant tin lead (SnPb) solderable termination finish for exempt applications and where pure tin is not acceptable. Other tin free termination finishes may also be available – please refer to the sales office for further details.

Radial components have tin plated leads as standard but tin/lead is available as a special option. Please refer to the radial section of the catalogue for further details.

X8R ranges <250Vdc are not RoHS 2011/65/EU compliant. Check the website, www.syfer.com for latest RoHS update.

Export controls and dual-use regulations

Certain Syfer catalogue components are defined as 'dual-use' items under international export controls - those that can be used for civil or military purposes which meet certain specified technical standards.

The defining criteria for a dual-use component with respect to Syfer products is one with a voltage rating of >750V and a capacitance value >250nF and a series inductance <10nH.

Components defined as 'dual-use' under the above criteria automatically require a licence for export outside the EU, and may

require a licence for export within the EU.

The application for a licence is routine, but customers for these products will be asked to supply further information.

Please refer to the sales office if you require any further information on export restrictions.

Other special components may additionally need to comply with export regulations.

IECQ-CECC and AEC-Q200 - Periodic tests

Periodic tests conducted for IECQ-CECC and AEC-Q200

Test ref	Test	Termination type	Additional requirements	Sample acceptance			Reference
				P	N	C	
P1	High temperature exposure (storage)	All types	Un-powered. 1,000 hours @ T=150°C. Measurement at 24 ± 2 hours after test conclusion	12	77	0	MIL-STD-202 Method 108
P2	Temperature cycling	COG/NP0: All types X7R: Y and H only	1,000 cycles -55°C to +125°C Measurement at 24 ± 2 hours after test conclusion	12	77	0	JESD22 Method JA-104
P3	Moisture resistance	All types	T = 24 hours/cycle. Note: Steps 7a and 7b not required. Un-powered. Measurement at 24 ± 2 hours after test conclusion	12	77	0	MIL-STD-202 Method 106
P4	Biased humidity	All types	1,000 hours 85°C/85%RH. Rated voltage or 50V whichever is the least and 1.5V. Measurement at 24 ± 2 hours after test conclusion	12	77	0	MIL-STD-202 Method 103
P5	Operational life	All types	Condition D steady state TA=125°C at full rated. Measurement at 24 ± 2 hours after test conclusion	12	77	0	MIL-STD-202 Method 108
P6	Resistance to solvents	All types	Note: Add aqueous wash chemical. Do not use banned solvents	12	5	0	MIL-STD-202 Method 215
P7	Mechanical shock	COG/NP0: All types X7R: Y and H only	Figure 1 of Method 213. Condition F	12	30	0	MIL-STD-202 Method 213
P8	Vibration	COG/NP0: All types X7R: Y and H only	5g's for 20 minutes, 12 cycles each of 3 orientations. Note: Use 8" x 5" PCB 0.031" thick 7 secure points on one long side and 2 secure points at corners of opposite sides. Parts mounted within 2" from any secure point. Test from 10-2,000Hz	12	30	0	MIL-STD-202 Method 204
P9	Resistance to soldering heat	All types	Condition B, no pre-heat of samples: Single wave solder - Procedure 2	3	12	0	MIL-STD-202 Method 210
P10	Thermal shock	COG/NP0: All types X7R: Y and H only	-55°C/+125°C. Number of cycles 300. Maximum transfer time - 20 seconds, dwell time - 15 minutes. Air-Air	12	30	0	MIL-STD-202 Method 107
P11	Adhesion, rapid temp change and climatic sequence	X7R: A, F and J only	5N force applied for 10s, -55°C/ +125°C for 5 cycles, damp heat cycles	12	27	0	BS EN132100 Clause 4.8, 4.12 and 4.13
P12	Board flex	COG/NP0: All types X7R: Y and H only	3mm deflection Class I 2mm deflection Class II	12	30	0	AEC-Q200-005
P13		X7R: A, F and J only	1mm deflection.	12	12	0	BS EN132100 Clause 4.9
P14	Terminal strength	All types	Force of 1.8kg for 60 seconds	12	30	0	AEC-Q200-006
P15	Beam load test	All types	-	12	30	0	AEC-Q200-003
P16	Damp heat steady state	All types	56 days, 40°C / 93% RH 15x no volts, 15x 5Vdc, 15x rated voltage or 50V whichever is the least.	12	45	0	BS EN132100 Clause 4.14

Test results are available on request.

P = Period in months.

N = Sample size.

C = Acceptance criteria.

Handling notes

Detailed application notes intended to guide and assist our customers in using multilayer ceramic capacitors in surface mount technology are available on the Syfer website www.syfer.com

The information concentrates on the handling, mounting, connection, cleaning, test and re-work requirements particular to MLC's for SMD technology, to ensure a suitable match between component capability and user expectation. Some extracts are given below.

Handling

Ceramics are dense, hard, brittle and abrasive materials. They are liable to suffer mechanical damage, in the form of chips or cracks, if improperly handled.

Terminations may be abraded onto chip surfaces if loose chips are tumbled in bulk. Metallic tracks may be left on the chip surfaces which might pose a reliability hazard.

Components should never be handled with fingers; perspiration and skin oils can inhibit solderability and will aggravate cleaning.

Chip capacitors should never be handled with metallic instruments. Metal tweezers should never be used as these can chip the product and may leave abraded metal tracks on the product surface. Plastic or plastic coated metal types are readily available and recommended - these should be used with an absolute minimum of applied pressure.

Counting or visual inspection of chip capacitors is best performed on a clean glass or hard plastic surface.

If chips are dropped or subjected to rough handling, they should be visually inspected before use. Electrical inspection may also reveal gross damage via a change in capacitance, an increase in dissipation factor or a decrease either in insulation resistance or electrical strength.

Transportation

Where possible, any transportation should be carried out with the product in its unopened original packaging. If already opened, any environmental control agents supplied should be returned to packaging and the packaging re-sealed.

Avoid paper and card as a primary means of handling, packing, transportation and storage of loose components. Many grades have a sulphur content which will adversely affect termination solderability.

Loose chips should always be packed with sulphur-free wadding to prevent impact or abrasion damage during transportation.

Storage

Incorrect storage of components can lead to problems for the user. Rapid tarnishing of the terminations, with an associated degradation of solderability, will occur if the product comes into contact with industrial gases such as sulphur dioxide and chlorine. Storage in free air, particularly moist or polluted air, can result in termination oxidation.

Packaging should not be opened until the MLC's are required for use. If opened, the pack should be re-sealed as soon as is practicable. Alternatively, the contents could be kept in a sealed container with an environmental control agent.

Long term storage conditions, ideally, should be temperature controlled between -5 and +40°C and humidity controlled between 40 and 60% R.H.

Taped product should be stored out of direct sunlight, which might promote deterioration in tape or adhesive performance.

Product, stored under the conditions recommended above, in its "as received" packaging, has a minimum shelf life of 2 years.

Mechanical considerations for mounted ceramic chip capacitors

Due to their brittle nature, ceramic chip capacitors are more prone to excesses of mechanical stress than other components used in surface mounting.

One of the most common causes of failure is directly attributable to bending the printed circuit board after solder attachment.

The excessive or sudden movement of the flexible circuit board stresses the inflexible ceramic block causing a crack to appear at the weakest point, usually the ceramic/termination interface. The crack may initially be quite small and not penetrate into the inner electrodes; however, subsequent handling and rapid changes in temperature may cause the crack to enlarge.

This mode of failure is often invisible to normal inspection techniques as the resultant cracks usually lie under the capacitor terminations but if left, can lead to catastrophic failure. More importantly, mechanical cracks, unless they are severe may not be detected by normal electrical testing of the completed circuit, failure only occurring at some later stage after moisture ingression.

The degree of mechanical stress generated on the printed circuit board is dependent upon several factors including the board material and thickness; the amount of solder and land pattern. The amount of solder applied is important, as an excessive amount reduces the chip's resistance to cracking.

It is Syfer's experience that more than 90% are due to board depanelisation, a process where two or more circuit boards are separated after soldering is complete. Other manufacturing stages that should be reviewed include:

- 1) Attaching rigid components such as connectors, relays, display panels, heat sinks etc.
- 2) Fitting conventional leaded components. Special care must be exercised when rigid terminals, as found on large can electrolytic capacitors, are inserted.
- 3) Storage of boards in such a manner which allows warping.
- 4) Automatic test equipment, particularly the type employing "bed of nails" and support pillars.
- 5) Positioning the circuit board in its enclosure especially where this is a "snap-fit".

Syfer were the first MLCC manufacturer to launch a flexible termination to significantly reduce the instances of mechanical cracking. FlexiCap™ termination introduces a certain amount of give into the termination layer absorbing damaging stress. Unlike similar systems, FlexiCap™ does not tear under tension, but absorbs the stress, so maintaining the characteristics of the MLCC.

SM Pad Design

Syfer conventional 2-terminal chip capacitors can generally be mounted using pad designs in accordance with IPC-7351, Generic Requirements for Surface Mount Design and Land Pattern Standards, but there are some other factors that have been shown to reduce mechanical stress, such as reducing the pad width to less than the chip width. In addition, the position of the chip on the board should also be considered.

3-Terminal components are not specifically covered by IPC-7351, but recommended pad dimensions are included in the Syfer catalogue / website for these components.

Soldering information

Soldering information

Syfer MLCCs are compatible with all recognised soldering/ mounting methods for chip capacitors. A detailed application note is available on-line at www.syfer.com

Reflow soldering surface mount chip capacitors

Syfer recommend reflow soldering as the preferred method for mounting MLCCs. Syfer MLCCs can be reflow soldered using a reflow profile generally as defined in IPC / JEDEC J-STD-020. Sn plated termination chip capacitors are compatible with both conventional and lead free soldering, with peak temperatures of 260°C to 270°C acceptable.

The heating ramp rate should be such that components see a temperature rise of 1.5°C to 4°C per seconds to maintain temperature uniformity through the MLCC.

The time for which the solder is molten should be maintained at a minimum, so as to prevent solder leaching. Extended times above 230°C can cause problems with oxidation of Sn plating. Use of inert atmosphere can help if this problem is encountered. PdAg terminations can be particularly susceptible to leaching with lead free, tin rich solders and trials are recommended for this combination.

Cooling to ambient temperature should be allowed to occur naturally, particularly if larger chip sizes are being soldered. Natural cooling allows a gradual relaxation of thermal mismatch stresses in the solder joints. Forced cooling should be avoided as this can induce thermal breakage.

Wave soldering Chip and Radial Leaded capacitors

Wave soldering is generally acceptable, but the thermal stresses caused by the wave have been shown to lead to potential problems with larger or thicker chips. Particular care should be taken when soldering SM chips larger than size 1210 and with a thickness greater than 1.0mm for this reason.

0402 size components are not suitable for wave soldering. 0402 size components can also be susceptible to termination leaching and reflow soldering is recommended for this size MLCC.

Maximum permissible wave temperature is 270°C for SM chips and 260°C for Radial Leaded capacitors.

The total immersion time in the solder should be kept to a minimum. It is strongly recommended that Sn/Ni plated terminations are specified for wave soldering applications. PdAg termination is particularly susceptible to leaching when subjected to lead free wave soldering and is not generally recommended for this application.

Total immersion exposure time for Sn/Ni terminations is 30s at a wave temperature of 260°C. Note that for multiple soldering operations, including the rework, the soldering time is cumulative.

The pre-heat ramp should be such that the components see a temperature rise of 1.5°C to 4°C per second as for reflow soldering. This is to maintain temperature uniformity through the MLCC and prevent the formation of thermal gradients within the ceramic. The preheat temperature should be within 120°C maximum (100°C preferred) of the maximum solder temperature to minimise thermal shock.

Cooling to ambient temperature should be allowed to occur naturally, particularly if larger chip sizes are being soldered. Natural cooling allows a gradual relaxation of thermal mismatch stresses in the solder joints. Forced cooling should be avoided as this can induce thermal breakage.

Rework of Chip capacitors

Syfer recommend hot air/ gas as the preferred method for applying heat for rework. Apply even heat surrounding the component to minimise internal thermal gradients. Soldering irons or other techniques that apply direct heat to the chip or surrounding area, should not be used as these can result in micro cracks being generated.

Minimise the rework heat duration and allow components to cool naturally after soldering.

Hand soldering Radial Leaded capacitors

Radial capacitors can be hand soldered into boards using soldering irons, provided care is taken not to touch the body of the capacitor with the iron tip. Soldering should be carried out from the opposite side of the board to the radial to minimise the risk of damage to the capacitor body. Where possible, a heat sink should be used between the solder joint and the body, especially if longer dwell times are required.

Use of silver loaded epoxy adhesives

Chip capacitors can be mounted to circuit boards using silver loaded adhesive provided the termination material of the capacitor is selected to be compatible with the silver loaded adhesive. This is normally PdAg. Standard tin finishes are often not recommended for use with silver loaded epoxies as there can be electrical and mechanical issues with the joint integrity due to material mismatch.

Solder leaching

Leaching is the term for the dissolution of silver into the solder causing a failure of the termination system which causes increased ESR, $\tan \delta$ and open circuit faults, including ultimately the possibility of the chip becoming detached. Leaching occurs more readily with higher temperature solders and solders with a high tin content. Pb free solders can be very prone to leaching certain termination systems. To prevent leaching, exercise care when choosing solder alloys and minimize both maximum temperature and dwell time with the solder molten.

Plated terminations with nickel or copper anti leaching barrier layers are available in a range of top coat finishes to prevent leaching occurring. These finishes also include Syfer FlexiCap™ for improved stress resistance post soldering.

Multilayer ceramic chip - with nickel or copper barrier termination

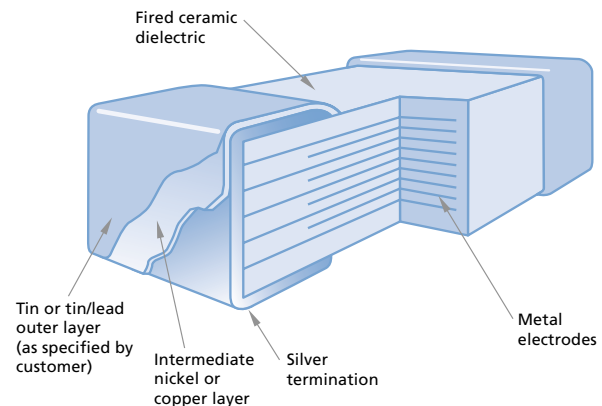

Chip dimensions

Dimensions

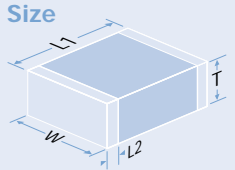

Size	Length (L1) mm inches	Width (W) mm inches	Max. Thickness (T) mm inches	Termination Band L2 mm inches	
				min	max
0402	1.0 ± 0.10 0.04 ± 0.006	0.50 ± 0.10 0.02 ± 0.003	0.60 0.024	0.10 0.004	0.40 0.015
0505	1.4 ± 0.38 0.055 ± 0.015	1.4 ± 0.25 0.055 ± 0.010	1.27 0.050	0.13 0.005	0.5 0.020
0603	1.6 ± 0.2 0.063 ± 0.008	0.8 ± 0.2 0.031 ± 0.008	0.8 0.031	0.10 0.004	0.40 0.015
0805	2.0 ± 0.3 0.08 ± 0.012	1.25 ± 0.2 0.05 ± 0.008	1.3 0.051	0.13 0.005	0.75 0.03
1111	2.79 + 0.51 - 0.25 0.110 + 0.020 - 0.010	2.79 ± 0.38 0.110 ± 0.015	1.8 0.071	0.13 0.005	0.63 0.025
1206	3.2 ± 0.3 0.126 ± 0.012	1.6 ± 0.2 0.063 ± 0.008	1.6 0.063	0.25 0.01	0.75 0.03
1210	3.2 ± 0.3 0.126 ± 0.012	2.5 ± 0.3 0.10 ± 0.012	2.0 0.08	0.25 0.01	0.75 0.03
1410	3.6 ± 0.3 0.14 ± 0.012	2.5 ± 0.3 0.10 ± 0.012	2.0 0.08	0.25 0.01	0.75 0.03
1806	4.5 ± 0.35 0.177 ± 0.012	1.6 ± 0.2 0.063 ± 0.008	1.3 0.051	0.25 0.01	0.75 0.03
1808	4.5 ± 0.35 0.18 ± 0.014	2.0 ± 0.3 0.08 ± 0.012	2.0 0.08	0.25 0.01	1.0 0.04
1812	4.5 ± 0.35 0.18 ± 0.014	3.2 ± 0.3 0.126 ± 0.012	3.2 0.126	0.25 0.01	1.0 0.04
1825	4.5 ± 0.35 0.18 ± 0.014	6.30 ± 0.4 0.25 ± 0.016	4.2 0.16	0.25 0.01	1.0 0.04
2211	5.7 ± 0.4 0.225 ± 0.016	2.79 ± 0.3 0.11 ± 0.012	2.5 0.1	0.25 0.01	0.8 0.03
2215	5.7 ± 0.4 0.225 ± 0.016	3.81 ± 0.35 0.35 ± 0.02	2.5 0.1	0.25 0.01	0.8 0.03
2220	5.7 ± 0.4 0.225 ± 0.016	5.0 ± 0.4 0.197 ± 0.016	4.2 0.16	0.25 0.01	1.0 0.04
2225	5.7 ± 0.4 0.225 ± 0.016	6.3 ± 0.4 0.25 ± 0.016	4.2 0.16	0.25 0.01	1.0 0.04
2520	6.30 ± 0.4 0.25 ± 0.016	5.0 ± 0.4 0.197 ± 0.016	4.2 0.16	0.25 0.01	1.0 0.04
3640	9.2 ± 0.5 0.36 ± 0.02	10.16 ± 0.5 0.40 ± 0.02	4.2 0.16	0.5 0.02	1.5 0.06
3820	9.65 ± 0.5 0.37 ± 0.02	5.0 ± 0.4 0.197 ± 0.016	4.2 0.16	0.5 0.02	1.5 0.06
3035	7.62 ± 0.4 0.30 ± 0.016	8.90 ± 0.5 0.35 ± 0.02	4.2 0.16	0.5 0.02	1.5 0.06
4045	10.2 ± 0.5 0.40 ± 0.02	11.5 ± 0.5 0.45 ± 0.02	4.2 0.16	0.5 0.02	1.5 0.06
4545	11.5 ± 0.5 0.45 ± 0.02	11.5 ± 0.5 0.45 ± 0.02	4.2 0.16	0.5 0.02	1.5 0.06
5550	14.0 ± 0.5 0.55 ± 0.02	12.7 ± 0.5 0.50 ± 0.02	4.2 0.16	0.5 0.02	1.5 0.06
5868	14.8 ± 0.5 0.58 ± 0.02	17.3 ± 0.5 0.68 ± 0.02	4.2 0.16	0.5 0.02	1.5 0.06
8040	20.3 ± 0.5 0.80 ± 0.02	10.16 ± 0.5 0.40 ± 0.02	4.2 0.16	0.5 0.02	1.5 0.06
8060	20.3 ± 0.5 0.80 ± 0.02	15.24 ± 0.5 0.60 ± 0.02	4.2 0.16	0.5 0.02	1.5 0.06

Custom chip sizes not included in the table, but larger than 2225, can be considered with minimum tooling charges. Please refer specific requests direct to the sales office.

Max thickness relates to standard components and actual thickness may be considerably less. Thicker parts, or components with reduced maximum thickness, can be considered by request – please refer requests to the sales office.

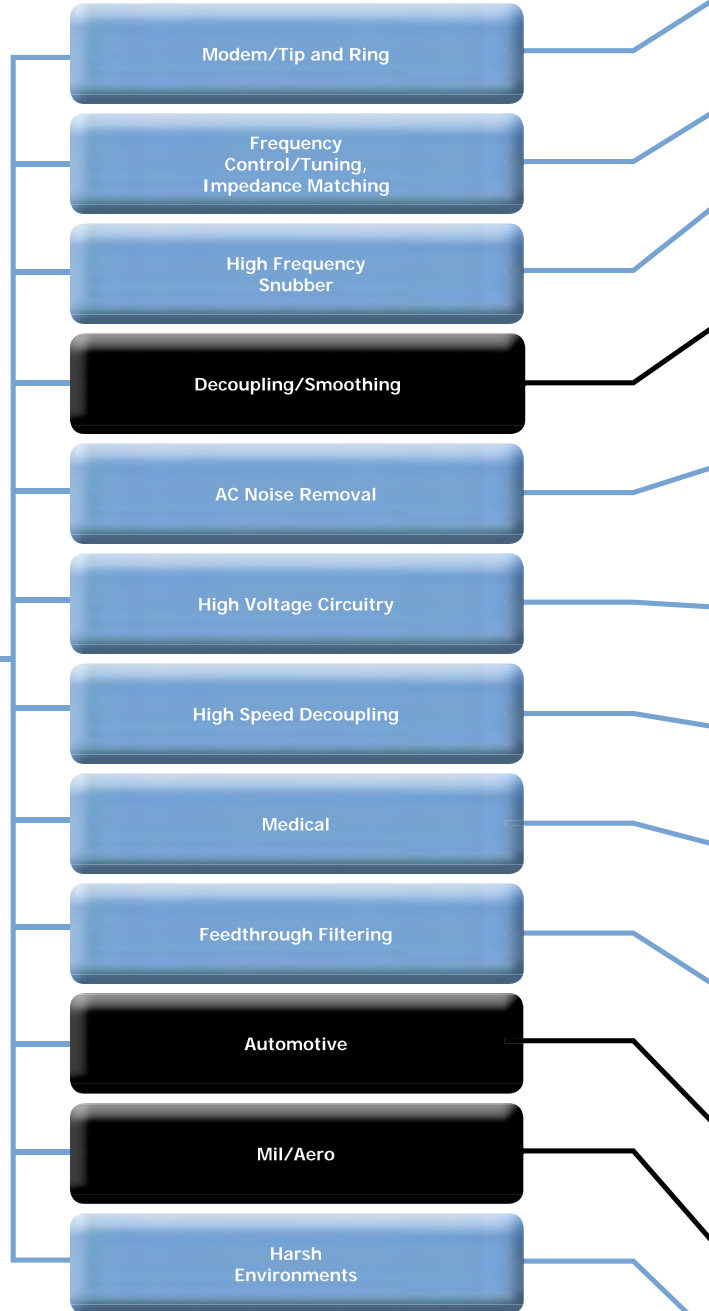
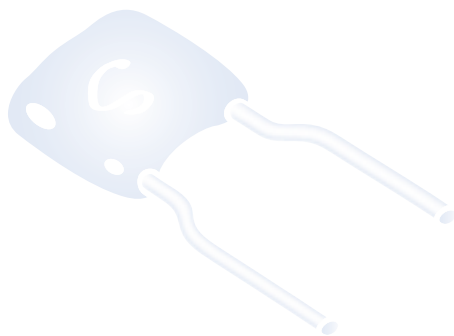
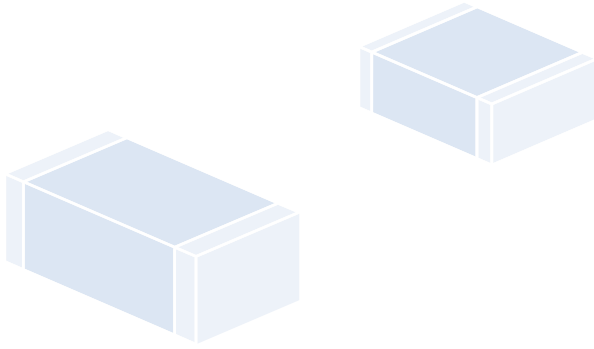

 **FlexiCap™** is particularly recommended for these applications where possible.

Product Selector

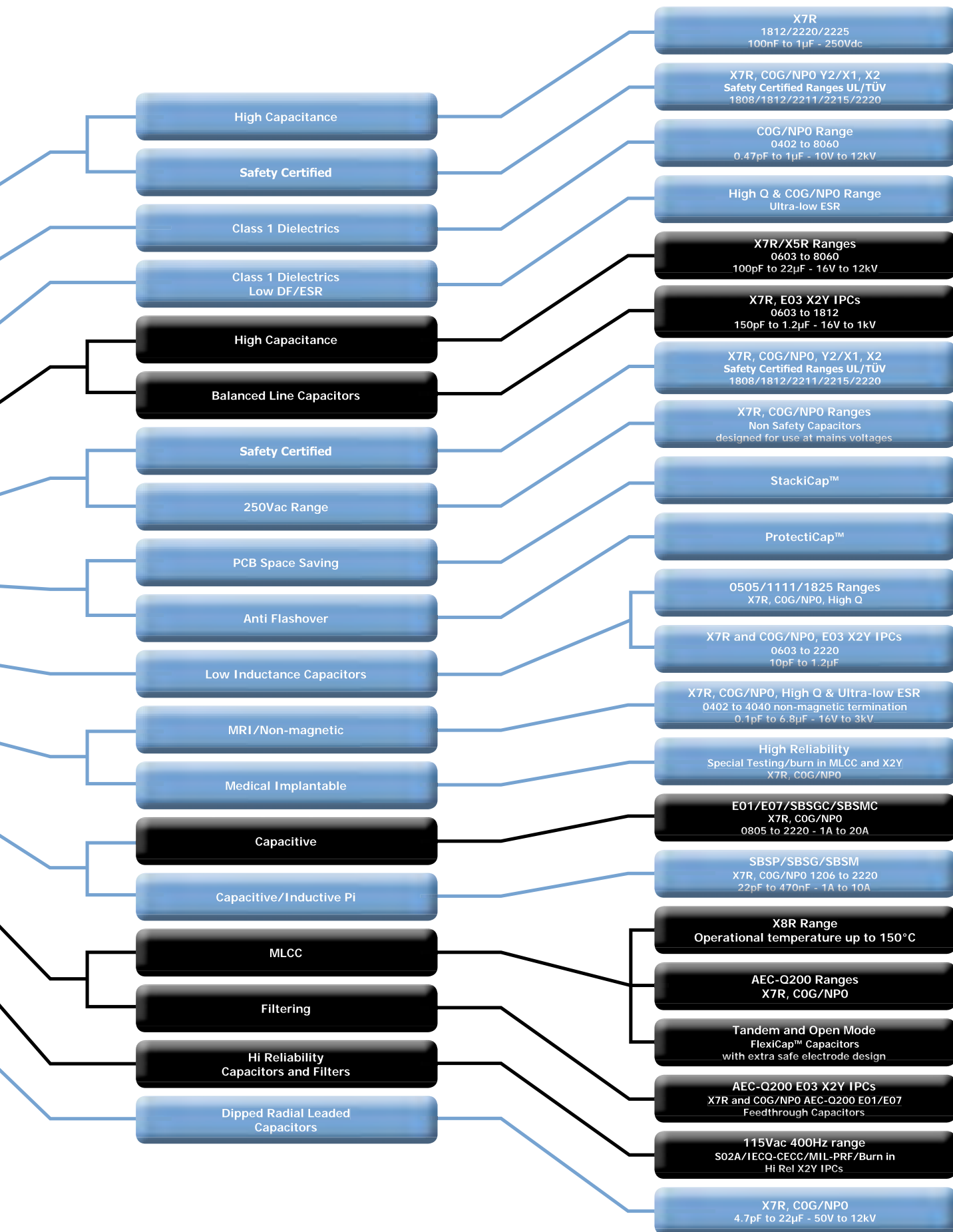

Standard MLCC ranges - 10Vdc to 12Vdc

A range of dc rated multi-layer chip capacitors from 0.47pF to 22µF and case sizes 0603 to 8060 in COG/NPO and X7R dielectrics. Suitable for all general purpose and high reliability applications where package size and reliability are important. All are manufactured using Syfer's unique wet process and incorporate precious metal electrodes.

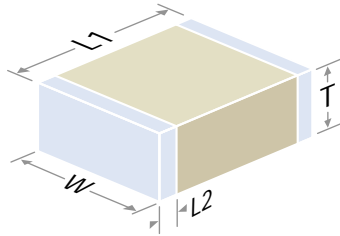

Range dimensions - Standard MLCC ranges

Size	Length (L1) mm/inches	Width (W) mm/inches	Max. Thickness (T) mm/inches	Termination Band (L2) mm/inches	
				min	max
0603	1.6 ± 0.2 0.063 ± 0.008	0.8 ± 0.2 0.031 ± 0.008	0.8 0.031	0.10 0.004	0.40 0.015
0805	2.0 ± 0.3 0.08 ± 0.012	1.25 ± 0.2 0.05 ± 0.008	1.3 0.051	0.13 0.005	0.75 0.03
1206	3.2 ± 0.3 0.126 ± 0.012	1.6 ± 0.2 0.063 ± 0.008	1.6 0.063	0.25 0.01	0.75 0.03
1210	3.2 ± 0.3 0.126 ± 0.012	2.5 ± 0.3 0.1 ± 0.012	2.0 0.08	0.25 0.01	0.75 0.03
1808	4.5 ± 0.35 0.18 ± 0.014	2.0 ± 0.3 0.08 ± 0.012	2.0 0.08	0.25 0.01	1.0 0.04
1812	4.5 ± 0.35 0.18 ± 0.014	3.2 ± 0.3 0.126 ± 0.012	2.5 0.1	0.25 0.01	1.0 0.04
1825	4.5 ± 0.35 0.18 ± 0.014	6.30 ± 0.4 0.25 ± 0.016	2.5 0.1	0.25 0.01	1.0 0.04
2220	5.7 ± 0.4 0.225 ± 0.016	5.0 ± 0.4 0.197 ± 0.016	4.2 0.16	0.25 0.01	1.0 0.04
2225	5.7 ± 0.4 0.225 ± 0.016	6.3 ± 0.4 0.25 ± 0.016	4.2 0.16	0.25 0.01	1.0 0.04
3640	9.2 ± 0.5 0.36 ± 0.02	10.16 ± 0.5 0.4 ± 0.02	2.5 0.1	0.5 0.02	1.5 0.06
5550	14.0 ± 0.5 0.55 ± 0.02	12.7 ± 0.5 0.5 ± 0.02	4.2 0.16	0.5 0.02	1.5 0.06
8060	20.3 ± 0.5 0.8 ± 0.02	15.24 ± 0.5 0.6 ± 0.02	2.5 0.1	0.5 0.02	1.5 0.06

Custom chip sizes not included in the table, but larger than 2225, can be considered with minimum tooling charges. Please refer specific requests direct to the sales office.

Max thickness relates to standard components and actual thickness may be considerably less. Thicker parts, or components with reduced maximum thickness, can be considered by request – please refer requests to the Sales Office.

Ordering information - Standard MLCC ranges

1210	Y	100	0103	J	X	T	---
Chip size	Termination	Voltage	Capacitance in picofarads (pF)	Capacitance tolerance	Dielectric	Packaging	Suffix code
0603	Y = FlexiCap™ termination base with nickel barrier (100% matte tin plating). RoHS compliant.	010 = 10V	<1.0pF Insert a P for the decimal point as the first character. eg. P300 = 0.3pF Values in 0.1pF steps ≥1.0pF & <10pF Insert a P for the decimal point as the second character. eg. 8P20 = 8.2pF Values are E24 series	<10pF H = ±0.05 pF B = ±0.10pF C = ±0.25pF D = ±0.50pF ≥ 10pF F = ±1% G = ±2% J = ±5% K = ±10% M = ±20%	C = COG/NPO (1B) X = X7R (2R1) P = X5R	T = 178mm (7") reel R = 330mm (13") reel B = Bulk pack - tubs or trays	Used for specific customer requirements
0805		016 = 16V					
1206		025 = 25V					
1210		050 = 50V					
1808	H = FlexiCap™ termination base with nickel barrier (Tin/lead plating with min. 10% lead). Not RoHS compliant.	063 = 63V	Values are E24 series				
1812		100 = 100V					
1825		200 = 200V					
2220		250 = 250V					
2225	F = Silver Palladium. RoHS compliant. J = Silver base with nickel barrier (100% matte tin plating). RoHS compliant. A = Silver base with nickel barrier (Tin/lead plating with min. 10% lead). Not RoHS compliant.	500 = 500V	First digit is 0. Second and third digits are significant figures of capacitance code. Fourth digit is number of zeros eg. 0101 = 100pF Values are E24 series				
3640		630 = 630V					
5550		1K0 = 1kV					
8060		1K2 = 1.2kV 1K5 = 1.5kV 2K0 = 2kV 2K5 = 2.5kV 3K0 = 3kV 4K0 = 4kV 5K0 = 5kV 6K0 = 6kV 8K0 = 8kV 10K = 10kV 12K = 12kV					

Standard MLCC - 10Vdc to 12kVdc - C0G/NP0 ranges

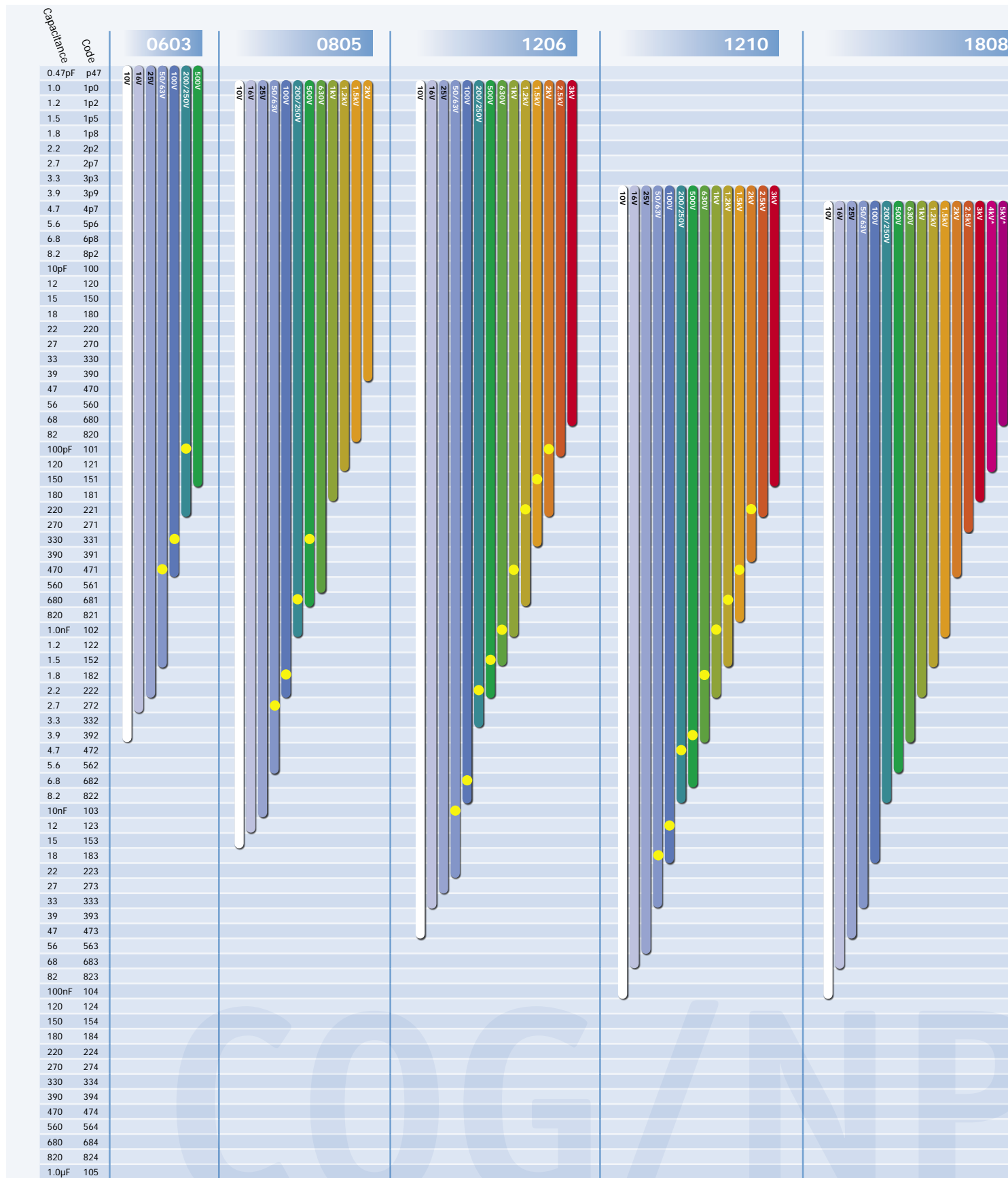

Note:

- *These parts may require conformal coating post soldering.
- Standard chip thickness = 2.5mm maximum unless specified as 3.2 or 4.0mm.

● = AEC-Q200 approved parts - maximum values.

Note: X7R ranges on reverse

Standard MLCC - 10Vdc to 12kVdc - X7R ranges

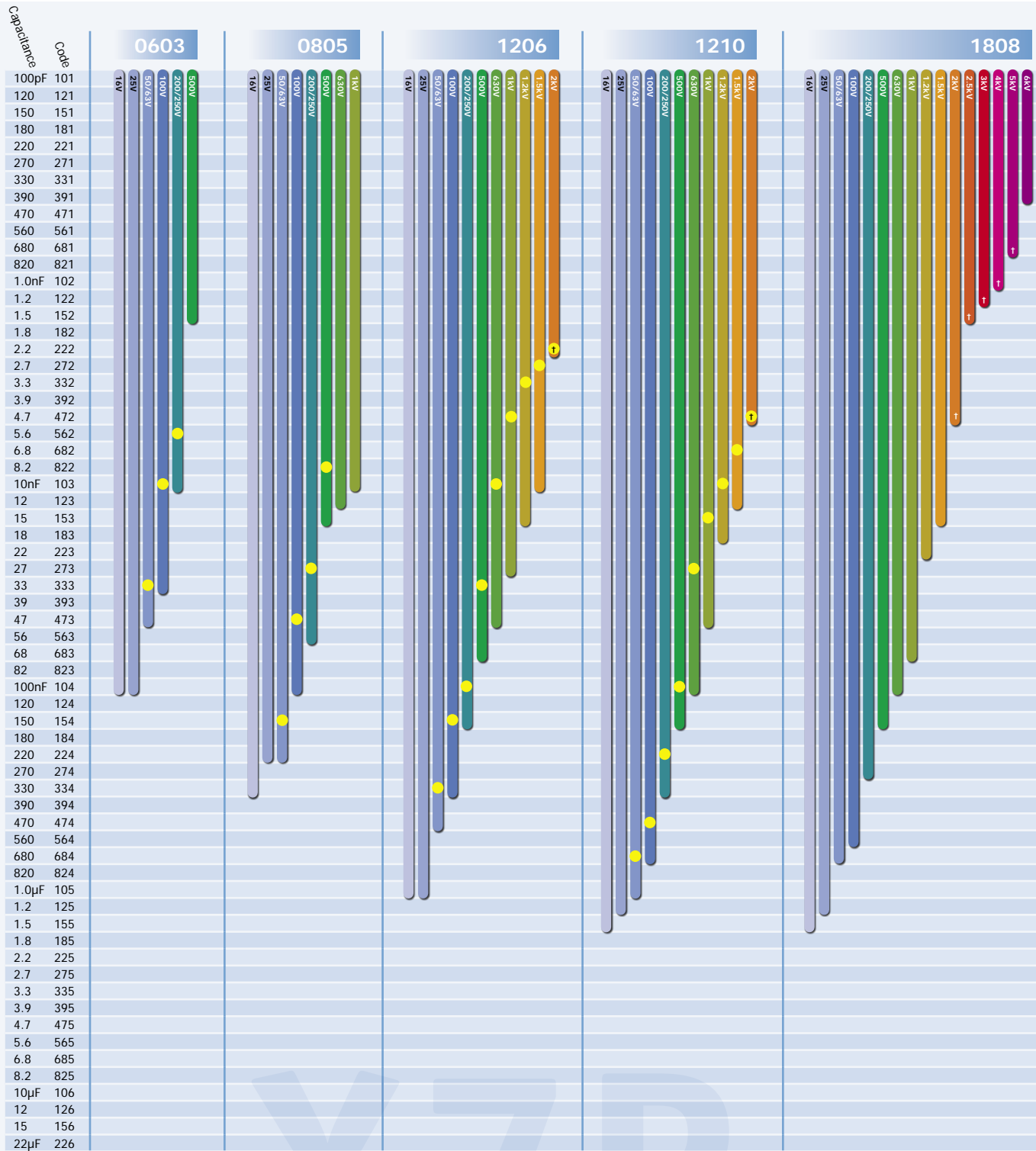

Note: COG/NPO ranges on reverse

Note: COG/NPO

ProtectiCap™ capacitors - X7R

MLCCs are particularly suitable for high voltage applications where small size is required. For standard high voltage capacitors a coating may be required to be applied post-soldering, to minimise the risk of flashover from one termination on the chip to the other. By contrast, the new ProtectiCap™ high voltage range has been introduced to specifically address this issue. The integral coating minimises the risk of flashover without any requirement for the customer to apply conformal coating after soldering.

This range is fully compliant with the RoHS and WEEE directives. Parts are compatible with lead free solders and standard aqueous and solvent cleaning processes.

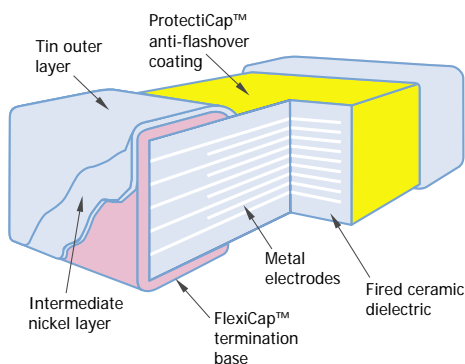

Operating Temperature

-55°C to +125°C

Temperature Coefficient of Capacitance (Typical)

±15%

Insulation resistance

Time constant (Ri xCr) (whichever is the least)

100GΩ or 1000s

Minimum/maximum capacitance values - ProtectiCap™ capacitors

Chip Size	1206	1210	1808	1812	2220
Min Cap	220pF	680pF	330pF	470pF	1.0nF
2000V	3.3nF	5.6nF	5.6nF	12nF	-
2500V	2.7nF	4.7nF	4.7nF	8.2nF	22nF
3000V	1.5nF	3.3nF	3.3nF	4.7nF	10nF
4000V	-	-	2.2nF	3.3nF	6.8nF
5000V	-	-	-	-	4.7nF
7" Reel	2,500	2,000	1,500	500/1,000*	500/1,000*
13" Reel	10,000	8,000	6,000	2,000/4,000*	2,000/4,000*

NOTE: Other capacitance values may become available, please contact the sales office if you need values other than those shown in the above table. For dimensions and soldering information, please go to our website (www.syfer.com) or see our MLC Catalogue.

*Reel quantity depends on chip thickness. Please contact the Sales Office.

Ordering information - ProtectiCap™ capacitors

1206	P	2K0	0102	K	X	T
Chip size	Termination	Voltage	Capacitance in picofarads (pF)	Capacitance tolerance	Dielectric	Packaging
1206 1210 1808 1812 2220	P = ProtectiCap™ (FlexiCap™ termination base with Ni barrier, 100% matte tin plating).	2K0 = 2kV 2K5 = 2.5kV 3K0 = 3kV 4K0 = 4kV 5K0 = 5kV	First digit is 0. Second and third digits are significant figures of capacitance code. The fourth digit is number of 0's following Example 0102 = 1000pF	J = ±5% K = ±10% M = ±20%	X = X7R	T = 178mm (7") reel R = 330mm (13") reel B = Bulk pack - tubs or trays

ProtectiCap™

TCC/VCC capacitors - X7R

TCC/VCC range

X7R capacitors are available from Syfer with a defined capacitance variation under applied dc voltage, across the full operating temperature range. Whilst the capacitance of C0G/NP0 chips does not vary with applied voltage, standard X7R capacitors exhibit capacitance fluctuation but with no specified limit.

For applications where a limit is required, Syfer is able to offer either a "B" code dielectric (conforms to MIL "BX" dielectric and IECQ-CECC "2X1") or "R" code dielectric (conforms to MIL "BZ" dielectric and IECQ-CECC "2C1").

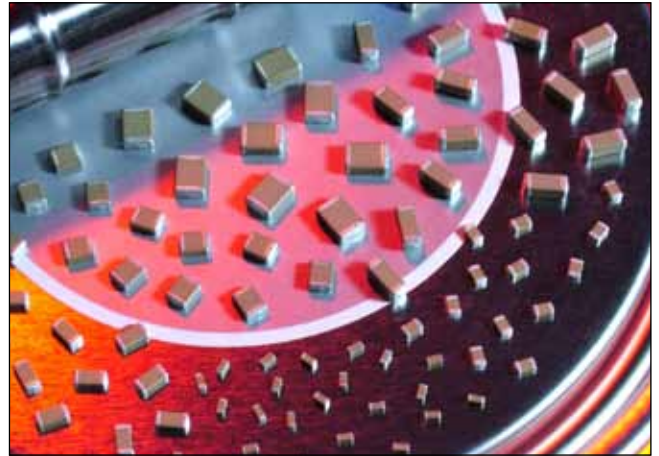

TCC/VCC capacitors - 2C1 (BZ)

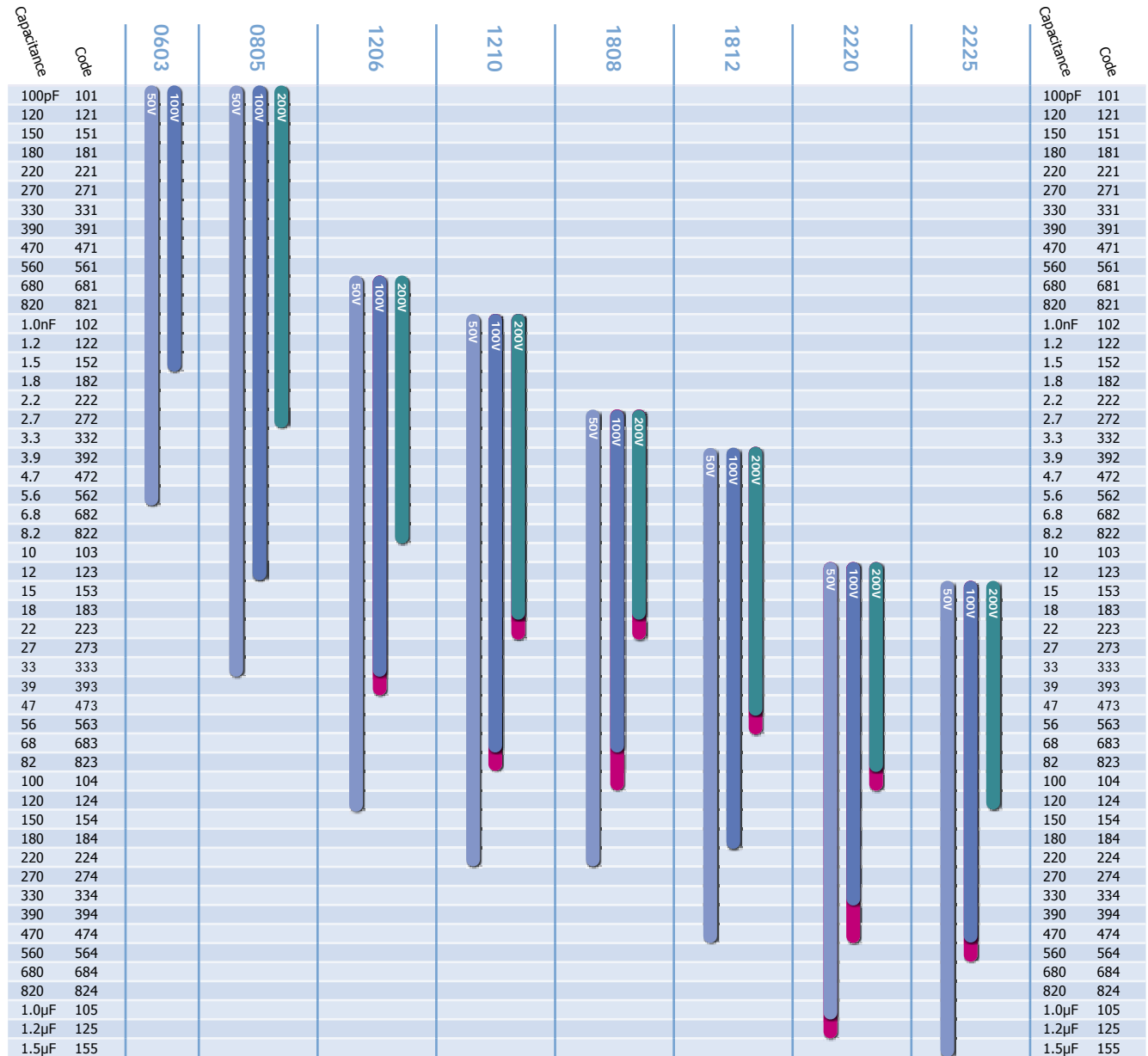

● = non RoHS compliant and FlexiCap™ termination only. Other values available in J, Y (FlexiCap™) and F terminations.

TCC/VCC capacitors - X7R

		X7R		
Dielectric characteristics		Stable		
	IECQ-CECC	2C1	2R1	2X1
	EIA	-	X7R	-
	MIL	BZ	-	BX
Rated temperature range		-55°C to +125°C		
Maximum capacitance change over temperature range No DC voltage applied		±20%	±15%	±15%
Rated DC voltage applied		+20-30%	-	+15-25%
Syfer dielectric ordering code		R	X	B

For part numbering, the "X" denoting the X7R dielectric code needs to be replaced by either "B" or "R". Please contact the sales office for full range information.

TCC/VCC capacitors - 2X1 (BX)

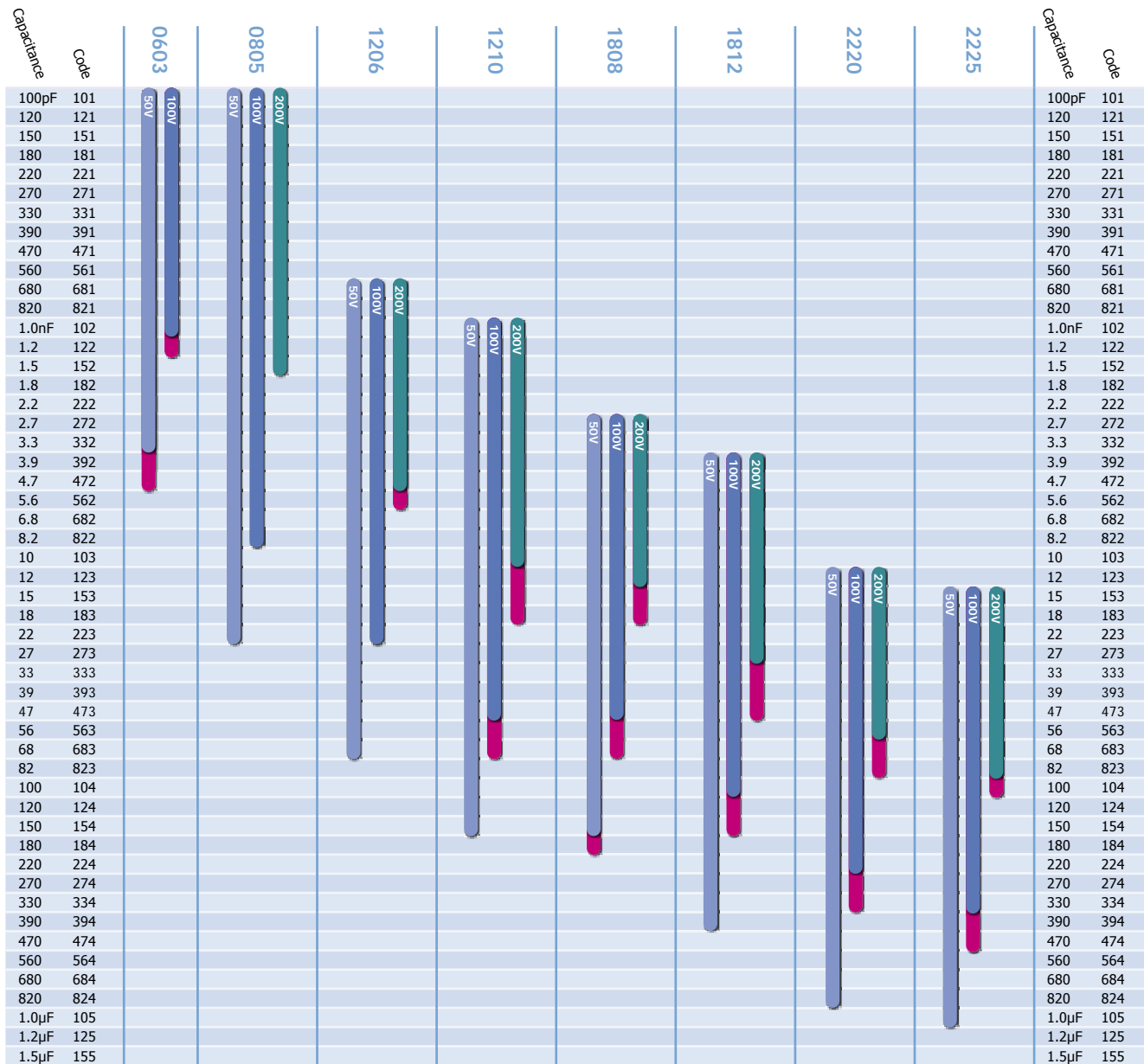

● = non RoHS compliant and FlexiCap™ termination only. Other values available in J, Y (FlexiCap™) and F terminations.

VC1 capacitors - X7R

VC1 residual range

The VC1 residual capacitance range MLCCs provide a more stable capacitance value with voltage - not to drop below 50% of the 1Vrms 1kHz value, up to full rated DC voltage, at room temperature.

They can be operated continuously at full rated voltage, but if de-rated will maintain a larger percentage of their original capacitance value, e.g. at 80% RV capacitance value equals 40% approx - see graph.

Defined capacitance value in case sizes from 0805 to 3640, with voltage rating up to 3kV. Ideal for Power supplies, capacitance critical circuits, smoothing circuits and EMI suppression.

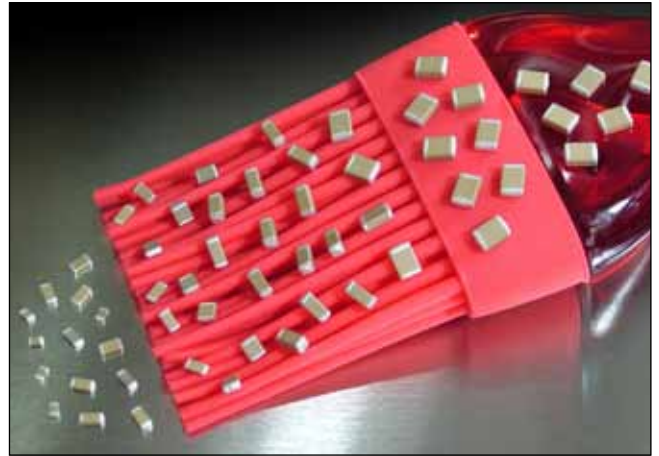

Operating Temperature

-55°C to +125°C

Temperature Coefficient (Typical)

± 15%

Insulation Resistance at +25°C

Time constant ($R_i \times C_r$) (whichever is the least)
100GΩ or 1000s

Aging Rate

Typically up to 2% per time decade

Minimum/maximum capacitance values - VC1 capacitors

Chip Size	0805	1206	1210	1808	1812	2220	2225	3640
Min Cap	100pF	150pF	220pF	220pF	470pF	1nF	1nF	2.2nF
250V	12nF	39nF	82nF	82nF	220nF	680nF	1μF	1.8μF
500V	2.2nF	6.8nF	15nF	15nF	56nF	150nF	220nF	560nF
630V	1.5nF	4.7nF	8.2nF	8.2nF	39nF	100nF	120nF	470nF
1000V	390pF	1.5nF	2.7nF	2.7nF	15nF	39nF	56nF	180nF
1200V	-	1nF	2.2nF	2.2nF	10nF	27nF	39nF	120nF
1500V	-	560pF	1.2nF	1.2nF	5.6nF	15nF	22nF	68nF
2000V	-	270pF	560pF	560pF	3.3nF	10nF	12nF	39nF
2500V	-	-	-	-	1.8nF	5.6nF	8.2nF	22nF
3000V	-	-	-	-	-	3.9nF	5.6nF	12nF

NOTE: Other capacitance values may become available, please contact our Sales Office if you need values other than those shown in the above table. For dimensions and soldering information, please go to our website (www.syfer.com).

Typical Performance Curves

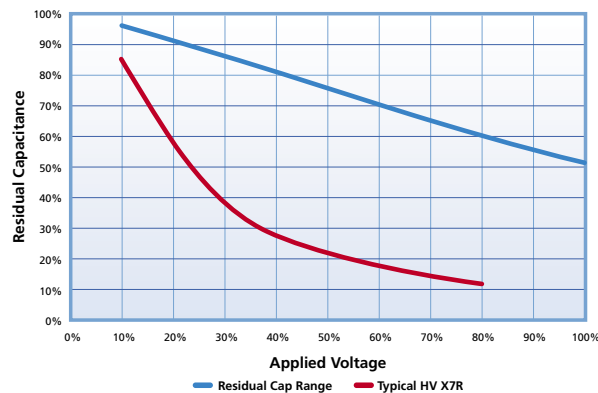

VC1 capacitors - X7R

Ordering information - VC1 capacitors

1206	Y	1K0	0152	K	X	T	VC1
Chip size	Termination	Voltage	Capacitance in picofarads (pF)	Capacitance tolerance	Dielectric	Packaging	Suffix
0805 1206 1210 1808 1812 2220 2225 3640	Y = FlexiCap™ termination base with nickel barrier (100% matte tin plating). RoHS compliant.	250 = 250V 500 = 500V 630 = 630V 1K0 = 1.0kV 1K2 = 1.2kV 1K5 = 1.5kV 2K0 = 2.0kV 2K5 = 2.5kV 3K0 = 3.0kV	First digit is 0. Second and third digits are significant figures of capacitance code. The fourth digit is number of 0's following Example: 0152 = 1500pF	J = ±5% K = ±10% M = ±20%	X = X7R	T = 178mm (7") reel R = 330mm (13") reel B = Bulk pack - tubs	

Reeled quantities - VC1 capacitors

Chip Size	0805	1206	1210	1812	1812	1812	1812	3640
7" Reel	3,000	2,500	2,000	500/1,000*	500/1,000*	500/1,000*	500/1,000*	n/a
13" Reel	12,000	10,000	8,000	2,000/4,000*	2,000/4,000*	2,000/4,000*	2,000/4,000*	500

*Reel quantity depends on chip thickness. Please contact Sales Office.

PSL capacitors - C0G/NP0 & X7R

PSL range

The PSL range of multilayer ceramic capacitors is suitable for a variety of applications including power supplies, DC-DC converters and LED lighting.

This range is manufactured to exacting standards using our unique screen printing process. This provides a high quality component suitable for demanding applications.



Now available with FlexiCap™ termination

Operating Temperature

-55°C to +125°C

Temperature Coefficient (Typical)

± 15%

Insulation Resistance at +25°C

Time constant ($R_i \times C_r$) (whichever is the least)
100GΩ or 1000s

Aging Rate

Typically less than 2% per time decade

Minimum/maximum capacitance values - PSL capacitors

Rated Voltage	Chip Size										
	0805		1206		1210		1808	1812		2220	
	C0G/NP0	X7R	C0G/NP0	X7R	C0G/NP0	X7R	C0G/NP0	C0G/NP0	X7R	C0G/NP0	X7R
50V / 63V	N/A	220pF - 100nF	N/A	470pF - 470nF	N/A	1nF - 1μF	N/A	N/A	N/A	N/A	N/A
100V	4.7pF - 1.5nF	220pF - 47nF	10pF - 3.3nF	470pF - 150nF	22pF - 5.6nF	1nF - 330nF	22pF - 5.6nF	47pF - 12nF	1nF - 680nF	68pF - 27nF	1nF - 1.5μF
200V / 250V	4.7pF - 1nF	220pF - 27nF	10pF - 2.2nF	470pF - 100nF	22pF - 4.7nF	1nF - 180nF	22pF - 4.7nF	47pF - 10nF	1nF - 470nF	68pF - 22nF	1nF - 1μF
500V	4.7pF - 470pF	220pF - 10nF	10pF - 1.5nF	470pF - 56nF	22pF - 3.3nF	1nF - 100nF	22pF - 3.3nF	47pF - 6.8nF	1nF - 220nF	68pF - 15nF	1nF - 560nF
630V	4.7pF - 220pF	220pF - 5.6nF	10pF - 1nF	470pF - 47nF	22pF - 2.2nF	1nF - 68nF	22pF - 2.2nF	47pF - 5.6nF	1nF - 150nF	68pF - 12nF	1nF - 330nF
1kV	4.7pF - 100pF	220pF - 3.3nF	10pF - 680pF	470pF - 10nF	22pF - 1.5nF	1nF - 22nF	22pF - 1.5nF	47pF - 4.7nF	1nF - 68nF	68pF - 10nF	1nF - 100nF 1nF - 120nF
1.5kV	4.7pF - 68pF	N/A	10pF - 390pF	N/A	22pF - 680pF	N/A	22pF - 680pF	47pF - 2.2nF	N/A	68pF - 4.7nF	N/A
2kV	4.7pF - 33pF	N/A	10pF - 220pF	470pF - 1nF 470pF - 2.2nF	22pF - 470pF	1nF - 4.7nF	22pF - 470pF	47pF - 1nF	1nF - 10nF	68pF - 2.2nF	N/A
2.5kV	N/A	N/A	10pF - 100pF	N/A	22pF - 150pF	N/A	22pF - 270pF	47pF - 680pF	N/A	68pF - 1.5nF	N/A
3kV	N/A	N/A	10pF - 68pF	N/A	22pF - 100pF	N/A	22pF - 220pF	47pF - 470pF	N/A	68pF - 1nF	N/A

Note: Other capacitance values may become available, please contact our Sales Office if you need values other than those shown in the above table. For dimensions and soldering information, please go to our website (www.syfer.com).

■ = AEC-Q200

PSL capacitors - COG/NP0 & X7R

Ordering information - PSL capacitors

1206	J	1K0	0103	K		J	T
Chip size	Termination	Voltage	Capacitance in picofarads (pF)	Capacitance tolerance		Dielectric	Packaging
0805 1206 1210 1808 1812 2220	J = Nickel barrier with 100% matte tin plating. RoHS compliant. Y =FlexiCap™ termination base with nickel barrier (100% matte tin plating). RoHS compliant. Lead free. (X7R only). Note: AEC-Q200 qualified parts only available with FlexiCap™ termination.	050 = 50V 063 = 63V 100 = 100V 200 = 200V 250 = 250V 500 = 500V 630 = 630V 1K0 = 1kV 1K5 = 1.5kV 2K0 = 2kV 2K5 = 2.5kV 3K0 = 3kV	First digit is 0. Second and third digits are significant figures of capacitance code. The fourth digit is number of 0's following Example: 0103 = 10000pF	X7R K = ±10% M = ±20%	COG/NP0 F = ±1% G = ±2% J = ±5% K = ±10%	G = COG/NP0 J = X7R S = X7R AEC-Q200	T = 178mm (7") reel R = 330mm (13") reel B = Bulk pack - tubs

Reeled quantities - PSL capacitors

Chip Size	0805	1206	1210	1808	1812	2220
7" Reel	3,000	2,500	2,000	1,500	500/1,000*	500/1,000*
13" Reel	12,000	10,000	8,000	6,000	2,000/4,000*	2,000/4,000*

*Reel quantity depends on chip thickness. Please contact our Sales Office.

High Q capacitors - MS range

The Syfer High Q MS range offers a very stable, High Q material system that provides excellent, low loss performance in systems below 3GHz. Available in 0402 to 3640 case sizes with various termination options including FlexiCap™, this range of high frequency capacitors is suitable for many applications where economical, high performance is required.

CapCad™ capacitor modelling software is now available for the HiQ range. This software has been developed with an easy to use and readily accessible comparison tool for choosing the best MLCC to suit the customer's needs. Please consult the Syfer website to launch the software.



Operating Temperature

-55°C to +125°C

Temperature Coefficient (Typical)

0 ± 30 ppm/°C

Insulation resistance at +25°C

>100GΩ

Insulation resistance at +125°C

>10GΩ

Minimum/maximum capacitance values - High Q capacitors - MS range

Chip Size	0402*	0603†	0505	0805†	1206	1111	1210	1812	2220	2225	3640
Min Cap	0.1pF	0.1pF	0.2pF	0.2pF	0.5pF	0.3pF	0.3pF	1.0pF	2.0pF	2.0pF	4.0pF
50V 63V	33pF	220pF	330pF	680pF	2.2nF						
100V	22pF	150pF	220pF	470pF	1.5nF	3.3nF	3.3nF	6.8nF	15nF	18nF	
150V	18pF	120pF	180pF	390pF	1.2nF	2.7nF	2.7nF	4.7nF	12nF	15nF	
200V 250V	15pF	100pF	150pF	330pF	1.0nF	2.2nF	2.2nF	3.9nF	10nF	10nF	
300V		56pF	100pF	220pF	680pF	1.5nF	1.5nF	3.3nF	6.8nF	8.2nF	
500V				100pF	330pF	820pF	820pF	2.2nF	4.7nF	5.6nF	15nF
630V					150pF	390pF	390pF	1.0nF	2.2nF	3.3nF	6.8nF
1000V					82pF	220pF	220pF	680pF	1.5nF	2.2nF	4.7nF
2000V					18pF	68pF	68pF	150pF	470pF	560pF	1.5nF
3000V								68pF	150pF	220pF	470pF
Tape quantities	7" reel 5000	7" reel 4000	7" reel 2500	7" reel 3000	7" reel 2500	7" reel 1000	7" reel 2000	7" reel 500/1000 13" reel 2000/4000	7" reel 500/1000 13" reel 2000/4000	7" reel 500/1000 13" reel 2000/4000	13" reel only
13" reel quantities available on request											

Below 1pF capacitance values are available in 0.1pF steps. Above 1pF capacitance values are available in E24 series values.

Other values and taping quantities may be available on request, consult the Sales Office for details. For values < than 0.3pF please consult the Sales Office for availability.

*0402 size - please consult the Sales Office for availability.

†0603 and 0805 sizes not recommended for new designs. Refer to Ultra-low ESR ranges on page 28.

Ordering information - High Q capacitors - MS range

0505	J	250	4P70	B	Q	T
Chip size	Termination	Voltage	Capacitance in picofarads (pF)	Capacitance tolerance	Dielectric	Packaging
0402* 0603† 0505 0805† 1206 1111 1210 1812 2220 2225 3640	J = Silver base with nickel barrier (100% matte tin plating). RoHS compliant. Lead free. A = Silver base with nickel barrier (Tin/lead plating with min. 10% lead). Not RoHS compliant.	050 = 50V 063 = 63V 100 = 100V 150 = 150V 200 = 200V 250 = 250V 300 = 300V 500 = 500V 630 = 630V 1K0 = 1kV 2K0 = 2kV 3K0 = 3kV	<1.0pF Insert a P for the decimal point as the first character. eg. P300 = 0.3pF Values in 0.1pF steps ≥1.0pF & <10pF Insert a P for the decimal point as the second character. eg. 8P20 = 8.2pF Values are E24 series ≥10pF First digit is 0. Second and third digits are significant figures of capacitance code. Fourth digit is number of zeros eg. 0101 = 100pF Values are E24 series	<4.7pF H = ±0.05pF B = ±0.1pF C = ±0.25pF D = ±0.5pF <10pF B = ±0.1pF C = ±0.25pF D = ±0.5pF ≥10pF F = ±1% G = ±2% J = ±5% K = ±10%	Q = High Q Ceramic	T = 178mm (7") reel R = 330mm (13") reel B = Bulk pack - tubs or trays

High Q capacitors - MS range

Typical performance data - 0805 chip size*

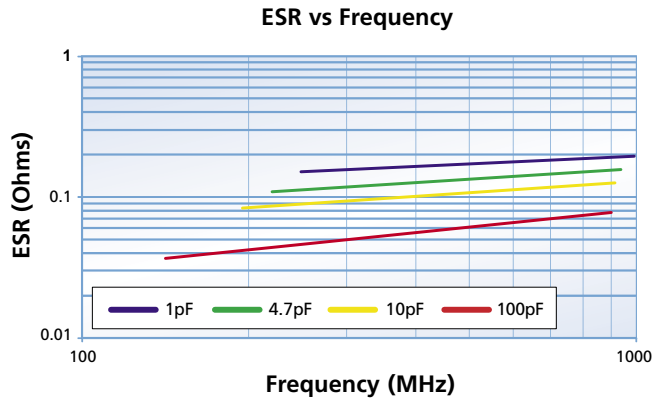

Typical performance data - 1111 chip size*

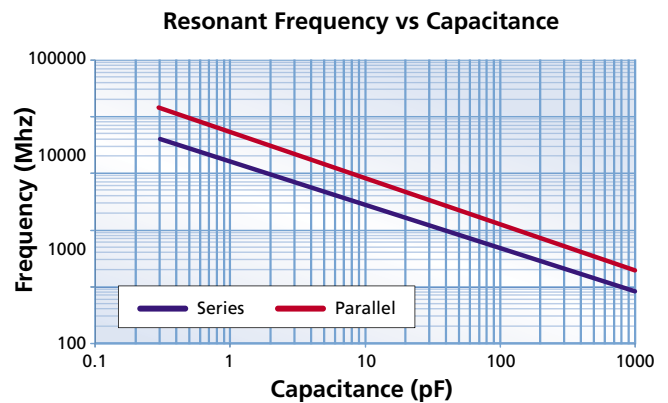
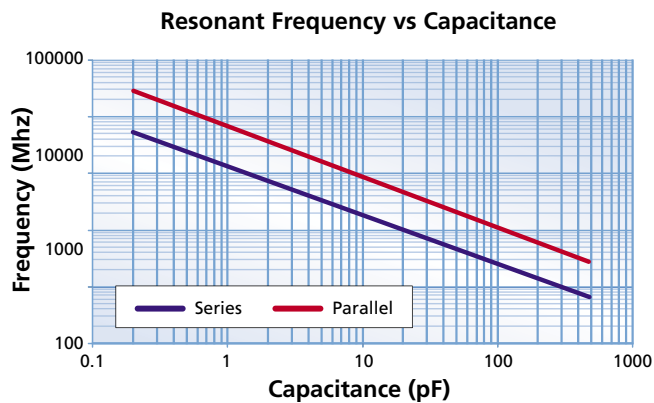
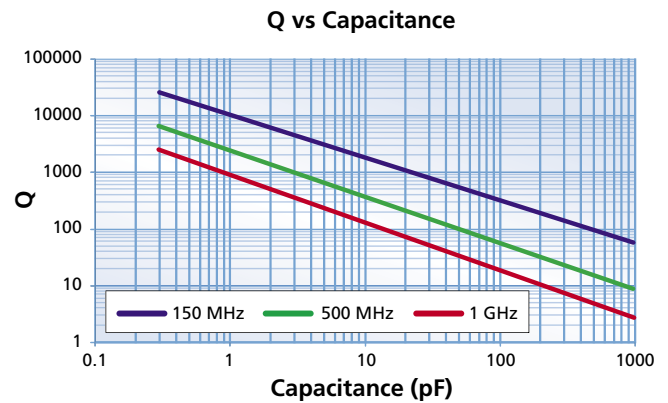
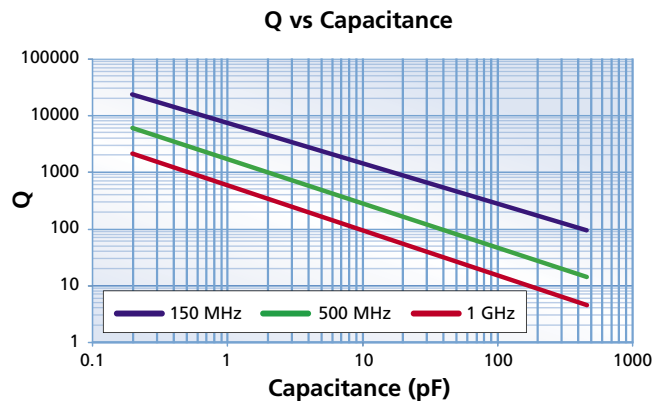
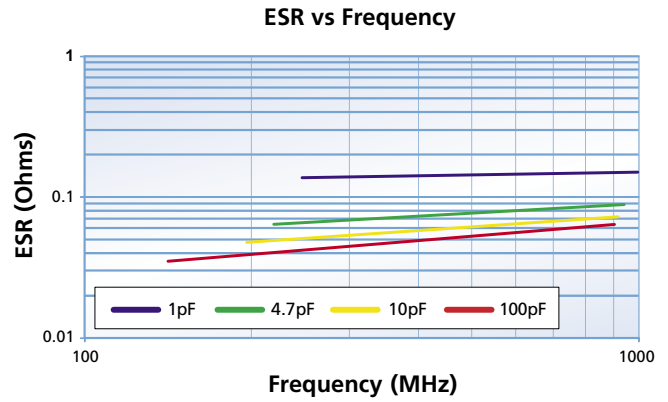

* Please refer to the Sales Office for other chip size electrical data.

Ultra-low ESR capacitors - COG/NP0

The Ultra-low ESR range offers a very stable, High Q material system that provides excellent, low loss performance in systems below 3GHz. Available with various termination options including FlexiCap™, this range of high frequency capacitors is suitable for many applications where economical, high performance is required.

0603 S-parameter downloads are available from: <http://www.knowlescapacitors.com/syfer/en/products/mlc-capacitors/ultra-low-esr-capacitors> and the Syfer MVP page on the Modelithics website. Please visit the Syfer MVP page for more information at: <http://www.modelithics.com/mvp/syfer>

Operating Temperature

-55°C to +125°C

Temperature Coefficient (Typical)

0 ± 30 ppm/°C

Insulation resistance

Time constant (Ri xCr) (whichever is the least)

100GΩ or 1000s



Minimum/maximum capacitance values - Ultra-low ESR capacitors

Chip Size	0603	0805
Min Cap	0.1pF	0.2pF
200V _{250V}	100pF	240pF
Tape quantities	7" reel - 4,000	7" reel - 3,000
	13" reel - 16,000	13" reel - 12,000

Note: Below 1pF capacitance values are available in 0.1pF steps. Above 1pF capacitance values are available in E24 series values. Other values and taping quantities may be available on request, consult the Sales Office for details.

Typical performance

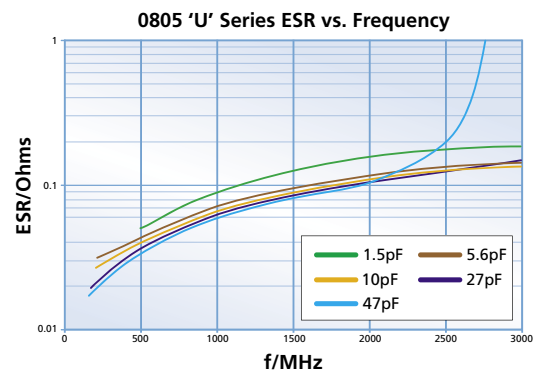
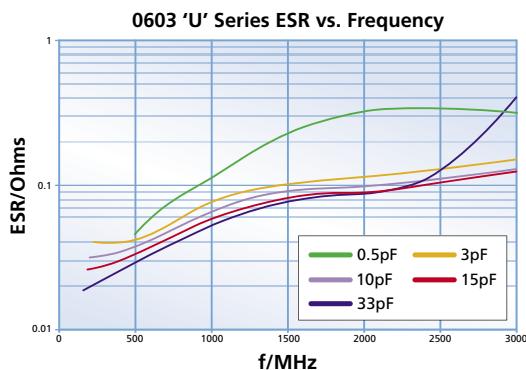

Ordering information - Ultra-low ESR capacitors

0805	J	250	0101	J	U	T
Chip size	Termination	Voltage	Capacitance in picofarads (pF)	Capacitance tolerance	Dielectric	Packaging
0603 0805	J = Silver base with nickel barrier (100% matte tin plating). RoHS compliant. Lead free. A = Silver base with nickel barrier (Tin/lead plating with min. 10% lead). Not RoHS compliant.	200 = 200V 250 = 250V	<1.0pF Insert a P for the decimal point as the first character. eg. P300 = 0.3pF Values in 0.1pF steps ≥1.0pF & <10pF Insert a P for the decimal point as the second character. eg. 8P20 = 8.2pF Values are E24 series ≥10pF First digit is 0. Second and third digits are significant figures of capacitance code. Fourth digit is number of zeros eg. 0101 = 100pF Values are E24 series	<4.7pF H = ±0.05pF B = ±0.1pF C = ±0.25pF D = ±0.5pF <10pF B = ±0.1pF C = ±0.25pF D = ±0.5pF ≥10pF F = ±1% G = ±2% J = ±5% K = ±10%	U = Ultra-low ESR	T = 178mm (7") reel R = 330mm (13") reel B = Bulk pack - tubs or trays

StackiCap™ capacitors - X7R

The StackiCap™ range offers a significant reduction in 'PCB real estate' for an equivalent capacitance value when board space is at a premium.

Syfer's unique patent pending* construction and FlexiCap™ termination material make the StackiCap™ range suitable for applications including: power supplies, lighting, aerospace electronics and high voltage applications where a large amount of capacitance is required. Further developments are on-going, please contact the Sales Office for details of the full range.

* Patent application No. 1210261-2 applies.



Maximum capacitance

Up to 5.6µF

Maximum voltage

Up to 2kV

Comparison chart - StackiCap™ capacitors

Chip Size	Voltage	StackiCap™ values (nF) *	Non- StackiCap™ range (nF)	Replaces Case Size
1812	200/250V	1000	680	2220
	500V	470	330	2220
	630V	330	180	2220
	1kV	180	100	2225 / 3640
	1.2kV	100	33	2225
	1.5kV	56	22	2225
2220	200/250V	2200	1000	3640
	500V	1000	560	3640
	630V	1000	330	5550
	1kV	470	120	8060
	1.2kV	220	82	5550
	1.5kV	150	47	5550
	2kV	100	27	8060
3640	200/250V	5600	3300	5550
	500V	2700	1000	8060
	630V	2200	680	8060
	1kV	1000	180	8060
	1.2kV	470	150	8060
	1.5kV	330	100	8060
	2kV	150	47	8060

■ = AEC-Q200. *Other capacitance values available. Please consult the Sales Office.

Ordering information - StackiCap™ capacitors

1812	Y	500	0474	J	X	T	WS2
Chip size	Termination	Voltage	Capacitance in picofarads (pF)	Capacitance tolerance	Dielectric	Packaging	Suffix code
1812 2220 3640	Y = FlexiCap™ termination base with nickel barrier (100% matte tin plating). RoHS compliant. Lead free. H = FlexiCap™ Termination base with nickel barrier (Tin/lead plating with minimum 10% lead). Not RoHS compliant.	200/250 = 200/250V 500 = 500V 630 = 630V 1K0 = 1kV 1K2 = 1.2kV 1K5 = 1.5kV 2K0 = 2kV	First digit is 0. Second and third digits are significant figures of capacitance code in picofarads (pF). Fourth digit is number of zeros eg. 0474 = 470nF Values are E12 series	J = ±5% K = ±10% M = ±20%	X = X7R E = X7R (2R1) AEC-Q200	T = 178mm (7") reel R = 330mm (13") reel B = Bulk pack - tubs or trays	WS2

Reeled quantities - StackiCap™ capacitors

	1812	2220	3640
178mm (7") Reel	500/1,000	500/1,000	-
330mm (13") Reel	2,000/4,000	2,000/4,000	500



Non-magnetic capacitors - COG/NP0, High Q, X7R

Multilayer ceramic capacitors with silver/palladium (Ag/Pd) terminations have often been used in medical applications where non-magnetic components are required, for example in MRI equipment. The use of conventional nickel barrier terminations is not suitable due to nickel exhibiting magnetic properties.

However, RoHS requirements have dictated the use of lead-free solders, and the composition of these solders has resulted in an increase in soldering temperatures. This has caused solder leaching problems for the Ag/Pd termination, and meant alternative terminations have had to be found.

As copper is non-magnetic, one solution is to use a copper barrier instead of a nickel barrier, with a tin finish on top and this is the solution Syfer has developed.

This Non-magnetic termination is offered with selected non-magnetic COG/NP0, High Q and X7R dielectrics, providing a fully non-magnetic component ($\mu_r = 1.0000$).

To meet high temperature 260°C soldering reflow profiles as detailed in J-STD-020, COG/NP0 dielectrics are supplied with FlexiCap™ or sintered termination and X7R dielectrics are supplied with Syfer's award winning FlexiCap™ termination.



COG/NP0 & High Q - minimum/maximum capacitance values

Chip Size	0402*	0603	0505	0805	1206	1111 1210	1808	1812	2220	2225
Min Cap	0.1pF	0.1pF	0.2pF	0.2pF	0.5pF	0.3pF	1.0pF	1.0pF	2.0pF	2.0pF
Min Cap Tolerance	±0.05pF (<4.7pF), 0.1pF (≥4.7pF & <10pF) and ±1% (≥10pF)									
50V 63V	22pF	100pF	220pF	470pF	1.5nF	-	-	-	-	-
100V	15pF	68pF	150pF	330pF	1.0nF	2.2nF	2.2nF	4.7nF	10nF	15nF
150V	10pF	47pF	100pF	220pF	680pF	1.5nF	1.5nF	3.3nF	6.8nF	10nF
200V 250V	6.8pF	33pF	56pF	150pF	470pF	1.0nF	1.0nF	2.2nF	4.7nF	6.8nF
300V	-	27pF	47pF	120pF	390pF	820pF	820pF	1.8nF	3.9nF	5.6nF
500V	-	-	-	68pF	270pF	680pF	680pF	1.5nF	3.3nF	4.7nF
630V	-	-	-	-	150pF	390pF	390pF	1.0nF	2.2nF	3.3nF
1000V	-	-	-	-	82pF	220pF	220pF	680pF	1.5nF	2.2nF
2000V	-	-	-	-	18pF	68pF	68pF	150pF	470pF	560pF
3000V	-	-	-	-	-	-	-	68pF	150pF	220pF

For values < than 0.3pF please consult the Sales Office for availability.

*0402 - please consult the sales office for availability.

X7R - minimum/maximum capacitance values

Chip Size	0402*	0603	0805	1206	1210	1808	1812	2220	2225
Min Cap	47pF	100pF	330pF	680pF	1.5nF	2.2nF	3.3nF	6.8nF	10nF
Min Cap Tolerance	±5%								
16V	10nF	100nF	330nF	1.0µF	1.5µF	1.5µF	3.3µF	5.6µF	6.8µF
25V	6.8nF	68nF	220nF	820nF	1.2µF	1.2µF	2.2µF	4.7µF	5.6µF
50V 63V	4.7nF	47nF	150nF	470nF	1.0µF	680nF	1.5µF	3.3µF	3.3µF
100V	1.5nF	10nF	47nF	150nF	470nF	330nF	1.0µF	1.5µF	1.5µF
200V 250V	680pF	5.6nF	27nF	100nF	220nF	180nF	470nF	1.0µF	1.0µF
500V	-	1.5nF	8.2nF	33nF	100nF	100nF	270nF	560nF	680nF
630V	-	-	4.7nF	10nF	27nF	33nF	150nF	330nF	390nF
1000V	-	-	3.3nF	4.7nF	15nF	18nF	56nF	120nF	150nF
1200V	-	-	-	3.3nF	10nF	10nF	33nF	82nF	100nF
1500V	-	-	-	2.7nF	6.8nF	6.8nF	22nF	47nF	68nF
2000V	-	-	-	2.2nF	4.7nF	4.7nF	10nF	27nF	33nF

*0402 - please consult the factory for availability.

Non-magnetic capacitors - COG/NP0, High Q, X7R

Ordering information - Non-magnetic capacitors

1210	3	100	0103	J	X	T	---
Chip size	Termination	Voltage	Capacitance in picofarads (pF)	Capacitance tolerance	Dielectric codes	Packaging	Suffix code
0402* 0603 0505 0805 1206 1111 1210 1808 1812 2220 2225	2 = Sintered silver base with copper barrier (100% matte tin plating). RoHS compliant. (Available on COG/NP0 & High Q only). 3 = FlexiCap™ base with copper barrier (100% matte tin plating). RoHS compliant. 4 = Sintered silver base with copper barrier (tin/lead plating). Non RoHS compliant. (Available on COG/NP0 & High Q only). 5 = FlexiCap™ base with copper barrier (tin/lead plating). Non RoHS compliant.	016 = 16V 025 = 25V 050 = 50V 063 = 63V 100 = 100V 150 = 150V 200 = 200V 250 = 250V 500 = 500V 630 = 630V 1K0 = 1kV 1K2 = 1.2kV 1K5 = 1.5kV 2K0 = 2kV 3K0 = 3kV	<10pF Insert a P for the decimal point, eg. P300 = 0.3pF, 8P20 = 8.2pF. ≥10pF 1st digit is 0. 2nd and 3rd digits are significant figures of capacitance code. The 4th digit is number of 0's following eg. 0103 = 10000pF Values <1pF in 0.1pF steps, above this values are E24 series	<4.7pF H = ±0.05pF B = ±0.1pF C = ±0.25pF D = ±0.5pF ≥4.7pF & <10pF B = ±0.1pF C = ±0.25pF D = ±0.5pF ≥10pF F = ±1% G = ±2% J = ±5% K = ±10% M = ±20%	C = COG/NP0 (1B) Q = High Q X = X7R (2R1)	T = 178mm (7") reel R = 330mm (13") reel B = Bulk pack - tubs or trays	Used for specific customer requirements

*0402 - please consult the sales office for availability.

Reeled Quantities

Chip Size	0402*	0603	0505	0805	1206	1111 1210	1808	1812	2220	2225
7" Reel	5000	4000	2500	3000	2500	1000/2000	2000	500/1000	500/1000	500/1000
13" Reel	13" reel quantities available on request						8000	2000/4000	2000/4000	2000/4000

Note: Other capacitance values may become available, please contact our Sales Office if you need values other than those shown in the above tables. For dimensions and soldering information, please go to our website (www.syfer.com) or see our MLC catalogue.

Typical performance data - 0805 chip size

ESR vs Frequency

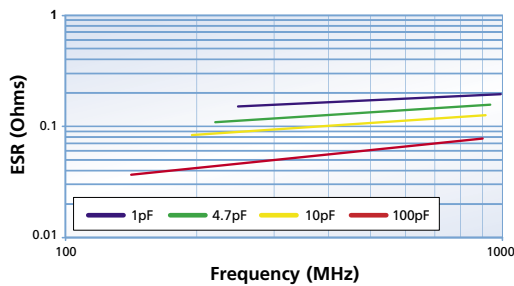

Q vs Capacitance

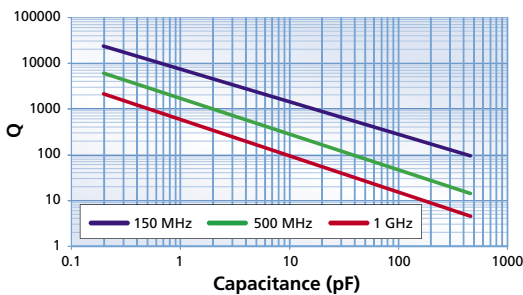

Resonant Frequency vs Capacitance

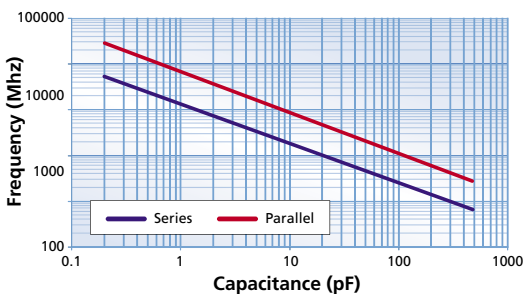

Typical performance data - 1111 chip size

ESR vs Frequency

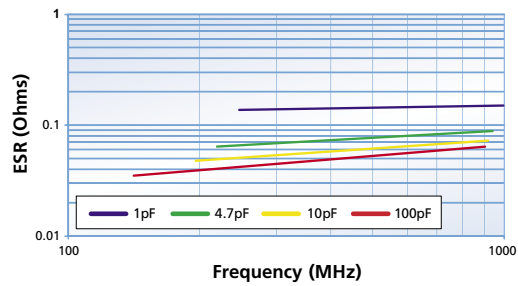

Q vs Capacitance

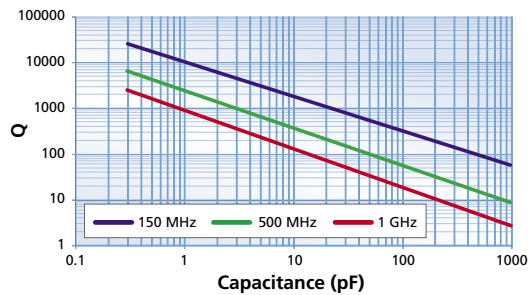

Resonant Frequency vs Capacitance

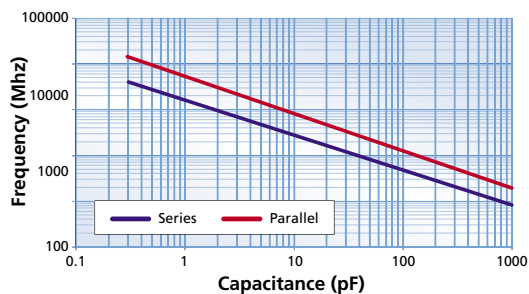

Non-magnetic Ribbon Leaded capacitors - C0G/NP0, High Q, X7R

Capacitance values

1pF to 27nF (High Q)

Chip sizes

2225 and 4040

Operating temperature

-55°C to +125°C

High Q low ESR dielectrics

(other options available)

Insulation Resistance (IR)

100Gohm min @ 100 Vdc or 1000s (whichever is the less)

DWV up to 8400Vdc

Termination material

Silver plated copper ribbon attached with HMP solder (MP greater than 260°C)



2225

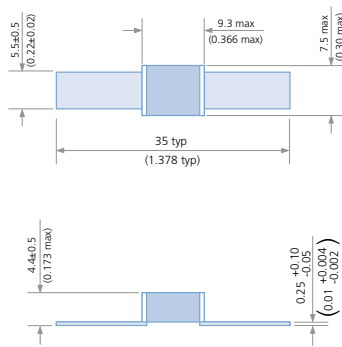

4040

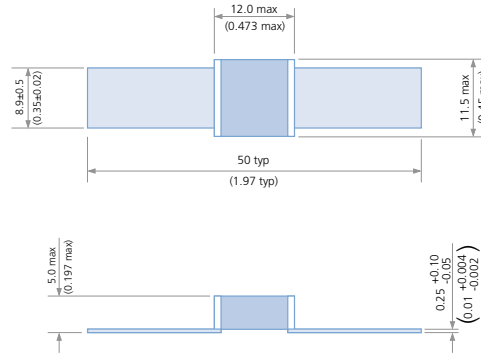

Min/max capacitance values

Chip Size	Case size 25 2225		Case size 40 4040	
	Min.	Max.	Min.	Max.
200V	6.2nF	10nF	16nF	27nF
500V	5.1nF	5.6nF	13nF	15nF
630V	3.9nF	4.7nF	12nF	12nF
1kV	1.2nF	3.3nF	5.6nF	10nF
2kV	510pF	1.0nF	1.6nF	5.1nF
3kV	1pF	47pF* / 470pF	910pF	1.5nF
4kV	-	-	620pF	820pF
5kV	-	-	390pF	560pF
6kV	-	-	160pF	330pF
7.2kV	-	-	1pF	56pF** / 150pF

*2225 - 47pF max. for dual rated @2.5kVac 30MHz **4040 - 56pF max. for dual rated @5kVac 30MHz.

Ordering information - Non-magnetic Ribbon Leaded capacitors

4040	B	7K0	0470	G	Q	B	Lead options	Variant code
Chip size	Coating	Voltage	Capacitance in picofarads (pF)	Capacitance tolerance	Dielectric	Packing	R	W001
2225 4040	B = Uncoated	200 = 200V 500 = 500V 1K0 = 1kV 2K0 = 2kV 3K0 = 3kV 5K0 = 5kV 7K0 = 7kV	<10pF Insert a P for the decimal point, eg 2P20 = 2.2pF. >10pF. 1st digit is 0. 2nd and 3rd digits are significant figures of capacitance code. The 4th digit is number of 0's following eg. 0470 = 47pF 0512 = 5100pF	<10pF B = ±0.10pF C = ±0.25pF D = ±0.50pF ≥10pF G = ±2% J = ±5% K = ±10% M = ±20%	C = C0G/NP0 (1B) Q = High Q X = X7R (2R1)	B = Bulk packed	R = Ribbon Leaded	W001 = Standard Variant

Open Mode and Tandem capacitors - X7R

Open Mode capacitors have been designed specifically for use in applications where mechanical cracking is a severe problem and short circuits due to cracking are unacceptable.

Open Mode capacitors use inset electrode margins, which prevent any mechanical cracks which may form during board assembly from connecting to the internal electrodes.

When combined with Syfer's FlexiCap™ termination, Syfer Open Mode capacitors provide a robust component with the assurance that if a part becomes cracked, the crack will be unlikely to result in short circuit failure.

Open Mode max capacitance (X7R only)

	0603	0805	1206	1210	1808	1812	2220	2225
16V	39nF	150nF	470nF	680nF	680nF	1.5µF	3.3µF	4.7µF
25V	33nF	120nF	330nF	560nF	560nF	1.2µF	2.2µF	3.9µF
50/63V	22nF	100nF	220nF	470nF	470nF	1.0µF	1.5µF	2.7µF
100V	6.8nF	27nF	100nF	220nF	220nF	680nF	1.0µF	1.8µF
200/250V	2.7nF	15nF	68nF	100nF	100nF	330nF	680nF	1.0µF
500V	-	5.6nF	27nF	68nF	68nF	180nF	330nF	330nF
630V	-	-	10nF	27nF	27nF	82nF	180nF	180nF
1kV	-	-	4.7nF	15nF	15nF	33nF	82nF	100nF

■ = AEC-Q200

Tandem Capacitors have been designed as a fail safe range using a series section internal design, for use in any application where short circuits would be unacceptable.

When combined with Syfer's FlexiCap™ termination, Syfer Tandem capacitors provide an ultra robust and reliable component, for use in the most demanding applications.

Non-standard voltages are available. For more information please consult the sales office.

Tandem max capacitance (X7R only)

	0603	0805	1206	1210	1812	2220	2225
16V	12nF	47nF	150nF	270nF	560nF	1.2µF	1.5µF
25V	10nF	39nF	120nF	220nF	470nF	1.0µF	1.2µF
50/63V	6.8nF	33nF	100nF	180nF	390nF	680nF	1.0µF
100V	2.2nF	10nF	47nF	82nF	220nF	470nF	680nF
200/250V	1.0nF	4.7nF	22nF	47nF	100nF	220nF	330nF

■ = AEC-Q200



Open Mode capacitor -

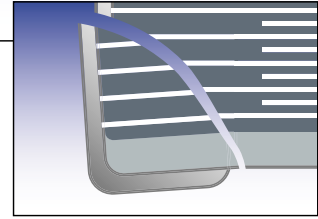

Qualification included cracking the components by severe bend tests. Following the bend tests cracked components were subjected to endurance / humidity tests, with no failures evident due to short circuits.

Note: Depending on the severity of the crack, capacitance loss was between 0% and 70%.



Tandem capacitor -

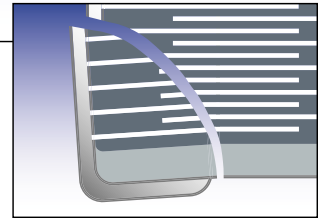

Qualification included cracking the components by severe bend tests. Following the bend tests cracked components were subjected to endurance / humidity tests, with no failures evident due to short circuits.

Note: Depending on the severity of the crack, capacitance loss was between 0% and 50%.

Ordering information - Open Mode and Tandem capacitors

1206	Y	050	0224	K	X	T	---
Chip size	Termination	Voltage	Capacitance in picofarads (pF)	Capacitance tolerance	Dielectric codes	Packaging	Suffix code
0603 0805 1206 1210 1808 1812 2220 2225	Y = FlexiCap™ termination base with nickel barrier (100% matte tin plating). RoHS compliant.	016 = 16V 025 = 25V 050 = 50V 063 = 63V 100 = 100V 200 = 200V 250 = 250V 500 = 500V 630 = 630V 1K0 = 1kV	First digit is 0. Second and third digits are significant figures of capacitance code. The fourth digit is number of zeros following. Example: 0224 = 220000pF	J = ±5% K = ±10% M = ±20%	X = X7R E = X7R (AEC-Q200 product)	T = 178mm (7") reel R = 330mm (13") reel B = Bulk pack - tubs or trays	M01 = Syfer Open Mode capacitor T01 = Syfer Tandem capacitor

IECQ-CECC range - Specialty High Rel. and approved parts

IECQ-CECC, AEC-Q200 and Space grade range

A range of specialist, high reliability, multilayer ceramic capacitors for use in critical or high reliability environments. All fully tested / approved and available with a range of suitable termination options, including tin/lead plating and Syfer FlexiCap™.

Ranges include :-

1. Range tested and approved in accordance with IECQ-CECC QC32100.
2. Range qualified to the requirements of AEC-Q200.
3. Range qualified to the requirements of Syfer detail specification S02A-0100 (based on ESCC 3009).



IECQ-CECC - maximum capacitance values

		0603	0805	1206	1210	1808	1812	2220	2225
16V	COG/NP0	1.5nF	6.8nF	22nF	33nF	33nF	100nF	150nF	220nF
	X7R	100nF	330nF	1.0µF	1.5µF	1.5µF	3.3µF	5.6µF	6.8µF
25V	COG/NP0	1.0nF	4.7nF	15nF	22nF	27nF	68nF	100nF	150nF
	X7R	56nF	220nF	820nF	1.2µF	1.2µF	2.2µF	4.7µF	5.6µF
50/63V	COG/NP0	470pF	2.7nF	10nF	18nF	18nF	33nF	68nF	100nF
	X7R	47nF	220nF	470nF	1.0µF	680nF	1.5µF	2.2µF	3.3µF
100V	COG/NP0	330pF	1.8nF	6.8nF	12nF	12nF	27nF	47nF	68nF
	X7R	10nF	47nF	150nF	470nF	330nF	1.0µF	1.5µF	1.5µF
200/ 250V	COG/NP0	100pF	680pF	2.2nF	4.7nF	4.7nF	12nF	22nF	27nF
	X7R	5.6nF	27nF	100nF	220nF	180nF	470nF	1.0µF	1.0µF
500V	COG/NP0	n/a	330pF	1.5nF	3.3nF	3.3nF	10nF	15nF	22nF
	X7R	n/a	8.2nF	33nF	100nF	100nF	270nF	560nF	820nF
1kV	COG/NP0	n/a	n/a	470pF	1.0nF	1.2nF	3.3nF	8.2nF	10nF
	X7R	n/a	n/a	4.7nF	15nF	18nF	56nF	120nF	150nF

Ordering information - IECQ-CECC and AEC-Q200 range

1210	Y	100	0103	J	D	T	---
Chip size	Termination	Voltage	Capacitance in picofarads (pF)	Capacitance tolerance	Dielectric Release codes	Packaging	Suffix code
0603 0805 1206 1210 1808 1812 1825 2220 2225 3640	Y = FlexiCap™ termination base with Ni barrier (100% matte tin plating). RoHS compliant. H = FlexiCap™ termination base with Ni barrier (Tin/lead plating with min. 10% lead). Not RoHS compliant. F = Silver Palladium. RoHS compliant. J = Silver base with nickel barrier (100% matte tin plating). RoHS compliant. A = Silver base with nickel barrier (Tin/lead plating with min. 10% lead). Not RoHS compliant.	016 = 16V 025 = 25V 050 = 50V 063 = 63V 100 = 100V 200 = 200V 250 = 250V 500 = 500V 630 = 630V 1K0 = 1kV 1K2 = 1.2kV 1K5 = 1.5kV 2K0 = 2kV 2K5 = 2.5kV 3K0 = 3kV	First digit is 0. Second and third digits are significant figures of capacitance code. The fourth digit is number of zeros following Example: 0103 = 10nF	<10pF B = ±0.1pF C = ±0.25pF D = ±0.5pF ≥ 10pF F = ±1% G = ±2% J = ±5% K = ±10% M = ±20%	D = X7R (2R1) with IECQ-CECC release F = COG/NP0 (1B/NP0) with IECQ-CECC release B = 2X1/BX released in accordance with IECQ-CECC R = 2C1/BZ released in accordance with IECQ-CECC For B and R codes please refer to TCC/VCC range for full capacitance values E = X7R (2R1) AEC-Q200 A = COG/NP0 (1B/NP0) AEC-Q200 T = X8R with AEC-Q200 release	T = 178mm (7") reel R = 330mm (13") reel B = Bulk pack - tubs or trays	Used for specific customer requirements

AEC-Q200 range - Specialty High Rel. and approved parts

AEC-Q200 range - maximum capacitance values

		0603	0805	1206	1210	1808	1812	1825	2220	2225	3640
50/63V	COG/NPO	470pF	2.7nF	10nF	18nF	n/a	39nF	68nF	68nF	100nF	220nF
	X7R	33nF	150nF	330nF	680nF	n/a	1.5µF	1.8µF	3.3µF	3.3µF	4.7µF
	X8R	n/a	33nF	120nF	220nF	270nF	470nF	n/a	680nF	1.0µF	n/a
100V	COG/NPO	330pF	1.8nF	6.8nF	12nF	n/a	27nF	47nF	47nF	68nF	180nF
	X7R	10nF	47nF	150nF	470nF	n/a	1µF	1.2µF	1.5µF	1.5µF	3.3µF
	X8R	n/a	15nF	56nF	120nF	150nF	220nF	n/a	470nF	560nF	n/a
200/ 250V	COG/NPO	100pF	680pF	2.2nF	4.7nF	n/a	12nF	22nF	22nF	27nF	82nF
	X7R	5.6nF	27nF	100nF	220nF	n/a	470nF	1.0µF	1.0µF	1.0µF	1.5µF
	X8R	n/a	10nF	33nF	68nF	82nF	120nF	n/a	220nF	330nF	n/a
500V	COG/NPO	n/a	330pF	1.5nF	3.9nF	n/a	10nF	15nF	15nF	22nF	56nF
	X7R	n/a	8.2nF	33nF	100nF	n/a	270nF	560nF	560nF	680nF	1.0µF
	X8R	n/a	3.9nF	18nF	39nF	47nF	100nF	n/a	180nF	270nF	n/a
630V	COG/NPO	n/a	n/a	1.0nF	1.8nF	n/a	5.6nF	8.2nF	10nF	15nF	39nF
	X7R	n/a	n/a	10nF	27nF	n/a	150nF	180nF	330nF	390nF	680nF
	X8R	n/a	1.8nF	3.9nF	10nF	12nF	33nF	n/a	150nF	180nF	n/a
1kV	COG/NPO	n/a	n/a	470pF	1nF	n/a	3.3nF	4.7nF	8.2nF	10nF	22nF
	X7R	n/a	n/a	4.7nF	15nF	n/a	56nF	120nF	120nF	150nF	180nF
	X8R	n/a	1nF	2.2nF	4.7nF	5.6nF	18nF	n/a	39nF	56nF	n/a
1.2kV	COG/NPO	n/a	n/a	220pF	680pF	n/a	3.3nF	3.9nF	4.7nF	6.8nF	18nF
	X7R	n/a	n/a	3.3nF	10nF	n/a	33nF	68nF	82nF	100nF	150nF
	X8R	n/a	n/a	1.8nF	3.9nF	4.7nF	12nF	n/a	33nF	39nF	n/a
1.5kV	COG/NPO	n/a	n/a	150pF	470pF	n/a	2.2nF	2.7nF	3.3nF	4.7nF	12nF
	X7R	n/a	n/a	2.7nF	6.8nF	n/a	22nF	47nF	47nF	68nF	100nF
	X8R	n/a	n/a	1.2nF	2.2nF	2.7nF	8.2nF	n/a	22nF	27nF	n/a
2kV	COG/NPO	n/a	n/a	100pF	220pF	n/a	1.5nF	1.2nF	1.8nF	2.2nF	5.6nF
	X7R	n/a	n/a	2.2nF	4.7nF	n/a	10nF	10nF	27nF	33nF	47nF
	X8R	n/a	n/a	470pF	1.2nF	1.8nF	4.7nF	n/a	12nF	18nF	n/a
2.5kV	X8R	n/a	n/a	n/a	n/a	1.0nF	2.7nF	n/a	6.8nF	10nF	n/a
3kV	X8R	n/a	n/a	n/a	n/a	680pF	2.2nF	n/a	4.7nF	5.6nF	n/a

3 Terminal EMI Components (E01) & (E07) - AEC-Q200 range - maximum capacitance values

		E01			E07		
		0805	1206	1806	0805	1206	1806
50V	COG/NPO	820pF	1.0nF	2.2nF	220pF	1nF	1.5nF
	X7R	47nF	100nF	200nF	47nF	100nF	200nF
100V	COG/NPO	560pF	1.0nF	2.2nF	120pF	560pF	680pF
	X7R	15nF	15nF	68nF	15nF	15nF	68nF

Note: For some lower capacitance parts, higher voltage rated parts may be supplied. Please refer to page 44.

X2Y Integrated Passive Components (E03) - AEC-Q200 range - capacitance values

		0805	1206	1410	1812
50V	COG/NPO	390pF - 470pF	1.2nF - 1.5nF	4.7nF - 5.6nF	8.2nF - 10nF
	X7R	18nF - 33nF	56nF - 150nF	180nF - 330nF	390nF - 560nF
100V	COG/NPO	10pF - 330pF	22pF - 1.0nF	100pF - 3.9nF	820pF - 6.8nF
	X7R	470pF - 15nF	1.5nF - 47nF	4.7nF - 150nF	8.2nF - 330nF

Note: For some lower capacitance parts, higher voltage rated parts may be supplied. Please refer to page 46.

S02A Space grade range - Specialty High Rel. and approved parts

S02A Space grade range - minimum/maximum capacitance values

		0603	0805	1206	1210	1812	2220	2225
16V	COG/NP0	390pF - 1.5nF	1pF - 6.8nF	1pF - 22nF	10pF - 33nF	220pF - 100nF	470pF - 150nF	560pF - 220nF
	X7R	330pF - 100nF	100pF - 330nF	680pF - 1.0μF	1.0nF - 1.5μF	3.9nF - 3.3μF	10nF - 5.6μF	18nF - 6.8μF
25V	COG/NP0	390pF - 1.0nF	1pF - 4.7nF	1pF - 15nF	10pF - 22nF	220pF - 68nF	470pF - 100nF	560pF - 150nF
	X7R	330pF - 56nF	100pF - 220nF	680pF - 820nF	1.0nF - 1.2μF	3.9nF - 2.2μF	10nF - 4.7μF	18nF - 5.6μF
50/63V	COG/NP0	0.5pF - 470pF	1pF - 2.7nF	1pF - 10nF	10pF - 18nF	220pF - 39nF	470pF - 68nF	560pF - 100nF
	X7R	330pF - 47nF	100pF - 220nF	680pF - 470nF	1.0nF - 1.0μF	3.9nF - 2.2μF	10nF - 3.3μF	18nF - 3.3μF
100V	COG/NP0	1pF - 330pF	1pF - 1.8nF	1pF - 6.8nF	10pF - 12nF	220pF - 27nF	470pF - 47nF	560pF - 68nF
	X7R	100pF - 10nF	100pF - 47nF	100pF - 150nF	1.0nF - 470nF	3.9nF - 1.0μF	10nF - 1.5μF	18nF - 1.5μF
200V	COG/NP0	1pF - 100pF	1pF - 680pF	1pF - 2.2nF	10pF - 4.7nF	220pF - 12nF	470pF - 22nF	560pF - 27nF
	X7R	100pF - 5.6nF	100pF - 27nF	100pF - 100nF	1.0nF - 220nF	3.9nF - 470nF	10nF - 1.0μF	18nF - 1.0μF
500V	COG/NP0	-	1pF - 270pF	1pF - 1.2nF	10pF - 2.7nF	180pF - 6.8nF	390pF - 15nF	4.7nF - 18nF
	X7R	-	10pF - 8.2nF	180pF - 33nF	390pF - 100nF	390pF - 270nF	1nF - 560nF	15nF - 820nF

Note: In accordance with ESCC 3009.

Ordering information - S02A Space grade range - product code construction

1210	A	100	0103	J	X	T	---
Chip size	Termination ⁽¹⁾	Voltage	Capacitance in picofarads (pF)	Capacitance tolerance	Dielectric Rel Release codes	Packaging	Suffix code
0603 0805 1206 1210 1812 2220 2225	<p>Y = FlexiCap™ termination base with nickel barrier (100% matte tin plating). RoHS compliant.</p> <p>H = FlexiCap™ termination base with nickel barrier (Tin/lead plating with min. 10% lead). Not RoHS compliant.</p> <p>F = Silver Palladium. RoHS compliant.</p> <p>A = Silver base with nickel barrier (Tin/lead plating with min. 10% lead). Not RoHS compliant. Available in COG/NP0 only.</p>	<p>016 = 16V 025 = 25V 050 = 50V 063 = 63V 100 = 100V 200 = 200V 500 = 500V</p>	<p>First digit is 0. Second and third digits are significant figures of capacitance code. The fourth digit is number of zeros following Example: 0103 = 10nF</p>	<p><10pF B = ±0.1pF C = ±0.25pF D = ±0.5pF</p> <p>≥ 10pF F = ±1% G = ±2% J = ±5% K = ±10% M = ±20%</p>	<p>C = COG/NP0 (1B) X = X7R (2R1)</p>	<p>T = 178mm (7") reel R = 330mm (13") reel B = Bulk pack - tubs or trays Q = Waffle pack</p>	<p>Used for specific customer requirements S02A = S (Space Grade) High Rel</p>

Notes:

- Termination **A**, **H** & **F** available for Space applications. If another termination type is required then contact the sales office.
- Please include Lot Acceptance Test requirement (LAT1, LAT2 or LAT3) on purchase order against each line item.
Tests conducted after 100% Burn-In (2xRV @125°C for 168 hours).
LAT1: 4 x adhesion, 8 x rapid temp change + LAT2 and LAT3.
LAT2: 20 x 1000 hour life test + LAT3.
LAT3: 6 x TC and 4 x solderability.
- S02A Space Grade Options**
S02A: with LAT1 (also incorporates LAT2 & LAT3).
S02A: with LAT2 (also incorporates LAT3).
S02A: with LAT3.
S02A: No LAT conducted.
S02A5: S02A design with 100% visual inspection and 100% electrical test verification.
No screening tests (including no burn in).
No LAT tests etc. These are typically ordered for Engineering Models.

Safety Certified capacitors

Safety Certified capacitors

Syfer Technology's Safety Certified capacitors comply with international UL and TÜV specifications to offer designers the option of using a surface mount ceramic multilayer capacitor to replace leaded film types. Offering the benefits of simple pick-and-place assembly, reduced board space required and lower profile, they are also available in a FlexiCap™ version to reduce the risk of mechanical cracking.

Syfer's high voltage capacitor expertise means the range offers among the highest range available of capacitance values in certain case sizes. Applications include: modems, AC-DC power supplies and where lightning strike or other voltage transients represent a threat to electronic equipment.

- Surface mount multilayer ceramic capacitors
- Meet Class Y2/X1, X1 and X2 requirements
- Approved for mains ac voltages, up to 250Vac
- Approved by UL and TÜV
- Sizes 1808, 1812, 2211, 2215 and 2220
- Smaller sizes suitable for use in equipment certified to EN60950
- Certification specifications for larger sizes include IEC/EN60384-14, UL/CSA60950 and UL60384-14
- Surface mount package

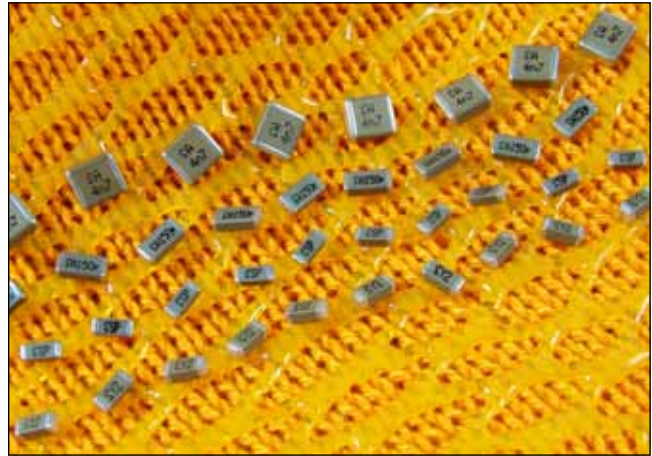

- Reduces board area and height restrictions
- Reduced assembly costs over conventional through hole components
- FlexiCap™ option available on all sizes
- Specific parts qualified to AEC-Q200

Class	Rated voltage	Impulse voltage	Insulation bridging	May be used in primary circuit
Y1	250Vac	8000V	Double or reinforced	Line to protective earth
Y2	250Vac	5000V	Basic or supplementary*	Line to protective earth
Y4	150Vac	2500V	Basic or supplementary*	Line to protective earth
X1	250Vac	4000V	-	Line to line
X2	250Vac	2500V	-	Line to line
X3	250Vac	None	-	Line to line

* 2 x Y2 or Y4 rated may bridge double or reinforced insulation when used in series.

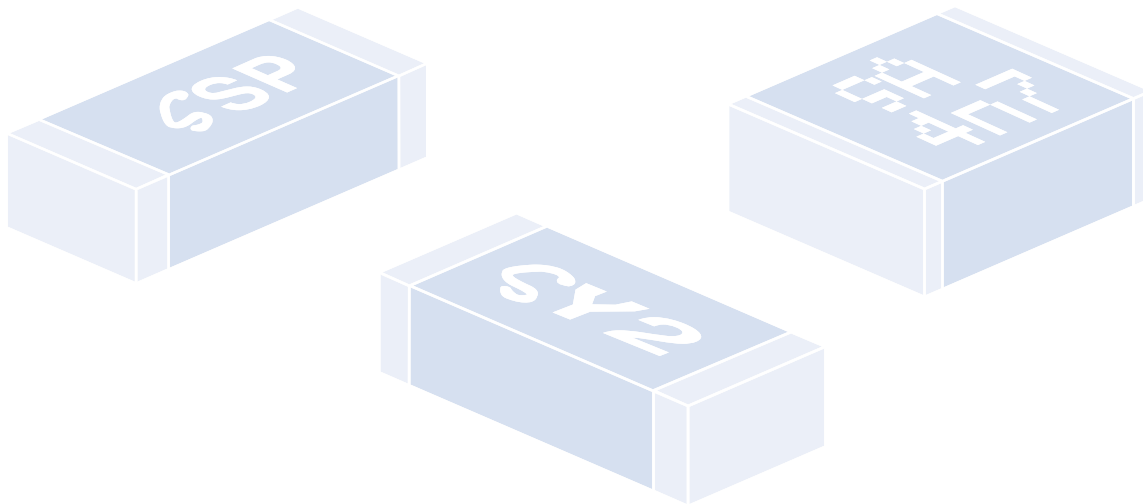

Safety Certified capacitors - Certification Chart

Classification and approval specification - Safety Certified capacitors

CHIP SIZE	DIELECTRIC	CAP RANGE	SYFER FAMILY CODE	CLASSIFICATION	APPROVAL SPECIFICATION	APPROVAL BODY	AEC-Q200
1808	COG/NPO	4.7pF to 1.5nF	SP ⁽¹⁾	X2	IEC60384-14 EN60384-14	TÜV	TÜV & UL FULL RANGE
				NWGQ2, NWGQ8	UL-60950-1, 2nd Ed CSA 60950-1-07 2nd Ed	UL	
1808	X7R	150pF to 4.7nF	SP ⁽¹⁾	X2	IEC60384-14 EN60384-14	TÜV	TÜV & UL FULL RANGE 'Y' TERM ONLY
				NWGQ2, NWGQ8	UL-60950-1, 2nd Ed CSA 60950-1-07 2nd Ed	UL	
1808	COG/NPO	4.7pF to 390pF	PY2 ⁽¹⁾	X1	IEC60384-14 EN60384-14	TÜV	TÜV & UL FULL RANGE
				NWGQ2, NWGQ8	UL-60950-1, 2nd Ed CSA 60950-1-07 2nd Ed	UL	
1808	X7R	150pF to 1nF std. term.* >1nF to 1.5nF P term. only	PY2 ^(1,3)	X1	IEC60384-14 EN60384-14	TÜV	TÜV & UL 1nF max. 'Y' TERM ONLY
				NWGQ2, NWGQ8	UL-60950-1, 2nd Ed CSA 60950-1-07 2nd Ed	UL	
1812	COG/NPO	4.7pF to 390pF	PY2 ⁽¹⁾	X1	IEC60384-14 EN60384-14	TÜV	TÜV & UL FULL RANGE
		4.7pF to 470pF					
1812	X7R	150pF to 2.2nF std. term.* >2.2nF to 4.7nF P term. only	PY2 ^(1,4)	X1	IEC60384-14 EN60384-14	TÜV	TÜV & UL 2.2nF max. 'Y' TERM ONLY
2211	COG/NPO	4.7pF to 1nF	SP ⁽²⁾	Y2/X1	IEC60384-14 EN60384-14	TÜV	TÜV & UL FULL RANGE
				NWGQ2, NWGQ8	UL-60950-1, 2nd Ed CSA 60950-1-07 2nd Ed	UL	
2211	X7R	100pF to 3.9nF	SP ⁽²⁾	Y2/X1	IEC60384-14 EN60384-14	TÜV	TÜV & UL FULL RANGE 'Y' & 'H' TERM ONLY
				NWGQ2, NWGQ8	UL-60950-1, 2nd Ed CSA 60950-1-07 2nd Ed	UL	
2215	COG/NPO	820pF to 1.0nF	SP ⁽²⁾	Y2/X1	IEC60384-14 EN60384-14	TÜV	TÜV & UL FULL RANGE
				NWGQ2, NWGQ8	UL-60950-1, 2nd Ed CSA 60950-1-07 2nd Ed	UL	
2215	X7R	2.7nF to 3.9nF	SP ⁽²⁾	Y2/X1	IEC60384-14 EN60384-14	TÜV	TÜV & UL FULL RANGE 'Y' & 'H' TERM ONLY
				NWGQ2, NWGQ8	UL-60950-1, 2nd Ed CSA 60950-1-07 2nd Ed	UL	
2220	X7R	150pF to 5.6nF	B16	Y2/X1 ⁽²⁾	IEC60384-14 EN60384-14	TÜV	TÜV & UL FULL RANGE 'Y' & 'H' TERM ONLY
				Y2/X1, ⁽¹⁾ FOWX2, FOWX8	UL-60384-14:2010 CSA E60384-14:09	UL	
2220	X7R	150pF to 22nF std. term.* >22nF to 33nF P term. only	B17 ^(2,5)	X2	IEC60384-14 EN60384-14	TÜV	TÜV ONLY 22nF max. 'Y' & 'H' TERM ONLY

Notes

Termination availability

- (1) J & Y terminations only.
- (2) J, Y, A & H terminations available.
- (3) For cap values >1000pF available in "P" ProtectiCap™ termination only.
- (4) For cap values >2200pF available in "P" ProtectiCap™ termination only.
- (5) B17 values above 22nF available in "P" ProtectiCap™ termination only.

PY2 Unmarked capacitors also available as released in accordance with approval specifications. Family code SY2 applies.

SP Unmarked capacitors also available as released in accordance with approval specifications. Family code SPU applies.

Capacitance values in red qualified to AEC-Q200.

*std. term. = Standard Termination.



Safety Certified capacitors - Ordering information

Ordering information - Safety Certified capacitors - Class SPU/SP ranges

1808	J	A25	0102	J	C	T	SP
Chip size	Termination	Voltage	Capacitance in picofarads (pF)	Capacitance tolerance	Dielectric codes	Packaging	Suffix code
1808 2211 2215	<p>J = Ni barrier</p> <p>Y = FlexiCap™ termination base with Ni barrier (100% matte tin plating). RoHS compliant.</p> <p>2211/2215 only</p> <p>A = Silver base with Ni barrier (Tin/lead plating with min. 10% lead). Not RoHS compliant.</p> <p>H = FlexiCap™ termination base with Ni barrier (Tin/lead plating with min. 10% lead). Not RoHS compliant.</p>	A25 = 250Vac	<p>First digit is 0. Second and third digits are significant figures of capacitance code. The fourth digit is number of zeros following.</p> <p>Example: 0102 = 1.0nF</p>	<p><10pF</p> <p>B = ±0.10pF</p> <p>C = ±0.25pF</p> <p>D = ±0.50pF</p> <p>≥ 10pF</p> <p>F = ±1%</p> <p>G = ±2%</p> <p>J = ±5%</p> <p>K = ±10%</p> <p>M = ±20%</p>	<p>C = COG/NP0</p> <p>X = X7R</p> <p>A = COG/NP0 (1B/NP0) AEC-Q200</p> <p>E = X7R (2B1) AEC-Q200</p>	<p>T = 178mm (7") reel</p> <p>R = 330mm (13") reel</p> <p>B = Bulk pack - tubs or trays</p>	<p>SP = Surge Protection capacitors (marked and approved)</p> <p>SPU = Surge Protection capacitors (un-marked parts are in accordance with, but not certified)</p>



Ordering information - Safety Certified capacitors - Class PY2/SY2

1808	J	A25	0102	J	X	T	PY2
Chip size	Termination	Voltage	Capacitance in picofarads (pF)	Capacitance tolerance	Dielectric codes	Packaging	Suffix code
1808 1812	<p>J = Ni barrier</p> <p>Y = FlexiCap™ termination base with Ni barrier (100% matte tin plating). RoHS compliant.</p> <p>P = ProtectiCap™ FlexiCap™ termination base with Ni barrier, (100% matte tin plating).</p>	A25 = 250Vac	<p>First digit is 0. Second and third digits are significant figures of capacitance code. The fourth digit is number of zeros following.</p> <p>Example: 0102 = 1.0nF</p>	<p><10pF</p> <p>B = ±0.10pF</p> <p>C = ±0.25pF</p> <p>D = ±0.50pF</p> <p>≥ 10pF</p> <p>F = ±1%</p> <p>G = ±2%</p> <p>J = ±5%</p> <p>K = ±10%</p> <p>M = ±20%</p>	<p>C = COG/NP0</p> <p>X = X7R</p> <p>A = COG/NP0 (1B/NP0) AEC-Q200</p> <p>E = X7R (2B1) AEC-Q200</p>	<p>T = 178mm (7") reel</p> <p>R = 330mm (13") reel</p> <p>B = Bulk pack - tubs or trays</p>	<p>PY2 = Safety tested Surge Protection capacitors (marked and approved)</p> <p>SY2 = Surge Protection capacitors (un-marked parts are in accordance with, but not certified)</p>



Ordering information - Safety Certified capacitors - Class B16/B17 ranges

2220	J	A25	0102	J	X	T	B16
Chip size	Termination	Voltage	Capacitance in picofarads (pF)	Capacitance tolerance	Dielectric codes	Packaging	Suffix code
2220	<p>J = Ni barrier</p> <p>Y = FlexiCap™ termination base with Ni barrier (100% matte tin plating). RoHS compliant.</p> <p>A = Silver base with Ni barrier (Tin/lead plating with min. 10% lead). Not RoHS compliant.</p> <p>H = FlexiCap™ termination base with Ni barrier (Tin/lead plating with min. 10% lead). Not RoHS compliant.</p> <p>P = ProtectiCap™ FlexiCap™ termination base with Ni barrier, (100% matte tin plating).</p>	A25 = 250Vac	<p>First digit is 0. Second and third digits are significant figures of capacitance code. The fourth digit is number of zeros following.</p> <p>Example: 0102 = 1.0nF</p>	<p>J = ±5%</p> <p>K = ±10%</p> <p>M = ±20%</p>	<p>X = X7R</p> <p>E = X7R (2B1) AEC-Q200</p>	<p>T = 178mm (7") reel</p> <p>1000 pieces</p> <p>R = 330mm (13") reel</p> <p>4000 pieces</p> <p>B = Bulk pack - tubs or trays</p>	<p>B16 = Type A: X1/Y2</p> <p>B17 = Type B: X2</p>



250Vac Non Safety Rated AC Capacitors - COG/NP0 & X7R

Industry wide standard multilayer ceramic capacitors are supplied with a DC rating only. For AC use Surge and Safety capacitors with an AC rating of 250Vac have been available but the capacitance range is limited as a result of the strict impulse and VP requirements in the international standards.

Knowles offers a solution in both our original and PSL range for operation up to 250Vac 60Hz continuous use provided for non-safety critical applications where extended capacitance ranges are required.

Capacitance range

Case sizes 0805 to 2220 are available in both X7R and COG/NP0 dielectrics with capacitances of up to 120nF. The capacitance ranges are divided into four groups which are based on the voltage coefficient of capacitance, COG/NP0 which has negligible capacitance shift with applied voltage and three subgroups of X7R. Type A with typical current flow of 0.093mA per nF @ 240V 50Hz, Type B with typical current flow of 0.082mA per nF @ 240V 50Hz and Type C with typical current flow of 0.06mA per nF @ 240V 50Hz.

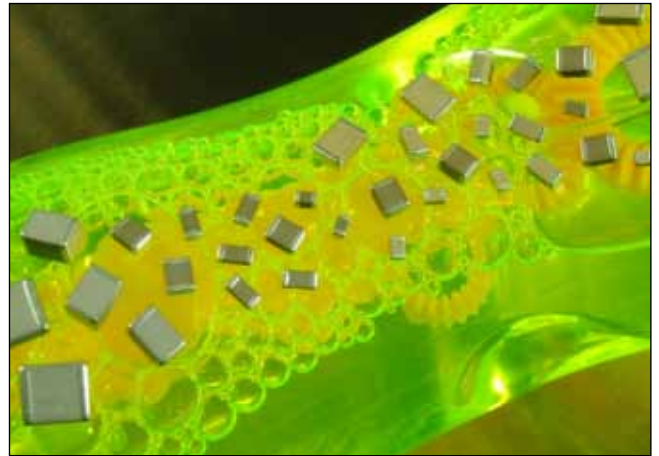

250Vac Non Safety Rated AC capacitors - minimum/maximum capacitance values

Chip size	0805	1206	1210	1808	1812	2220
COG/NP0	1.0pF - 470pF	1.0pF - 1.2nF	4.7pF - 2.2nF	4.7pF - 2.2nF	10pF - 5.6nF	10pF - 10nF
X7R - A	560pF - 1.5nF	1.5nF - 10nF	2.7nF - 22nF	2.7nF - 22nF	6.8nF - 56nF	12nF - 120nF
X7R - B	1.8nF - 3.3nF	12nF	27nF	27nF	68nF - 82nF	-
X7R - C	3.9nF - 10nF	15nF - 47nF	33nF - 100nF	33nF - 100nF	100nF - 120nF	-
PSL X7R - A	-	3.3nF - 10nF	10nF - 22nF	-	10nF - 68nF	47nF - 120nF
PSL X7R - C	-	12nF - 22nF	27nF - 68nF	-	82nF - 100nF	-

Note: Please see website for further details.

Ordering information - 250Vac Non Safety Rated AC capacitors

1812	Y	A25	0103	K	X	T
Chip size	Termination	Voltage	Capacitance in picofarads (pF)	Capacitance tolerance	Dielectric codes	Packaging
0805 1206 1210 1808 1812 2220	Y = FlexiCap™ termination base with nickel barrier (100% matte tin plating). RoHS compliant. J = Silver base with nickel barrier (100% matte tin plating). RoHS compliant.	A25 = 250Vac 60Hz	<10pF Insert a P for the decimal point, eg P300 = 0.3pF, 8P20 = 8.2pF. ≥10pF 1st digit is 0, 2nd and 3rd digits are significant figures of capacitance code. The 4th digit is number of 0's following eg. 0103 = 10nF	<10pF B = ±0.1pF C = ±0.25pF D = ±0.5pF ≥10pF F = ±1% G = ±2% J = ±5% K = ±10% M = ±20%	C = COG/NP0 X = X7R J = PSL X7R	T = 178mm (7") reel R = 330mm (13") reel B = Bulk pack - tubs or trays

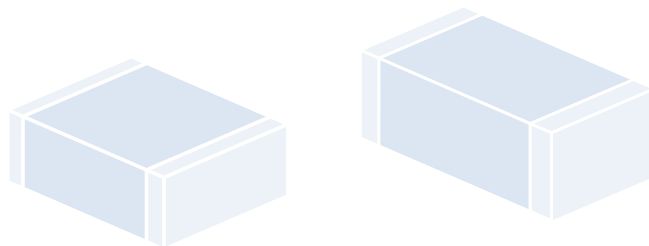

115Vac 400Hz capacitors - COG/NP0, X7R

115Vac 400Hz capacitors for aerospace applications

Syfer Technology has conducted reliability testing on standard surface mount ceramic capacitors in order to ensure their performance at 115Vac 400Hz and the associated voltage and frequency transients required by MIL-STD-704. Self heating will occur due to losses in the capacitor but has been measured at less than 25°C rise with neutral mounting conditions at room temperature.

Please note that the 115V 400Hz ranges are not RoHS 2011/65/EU compliant.

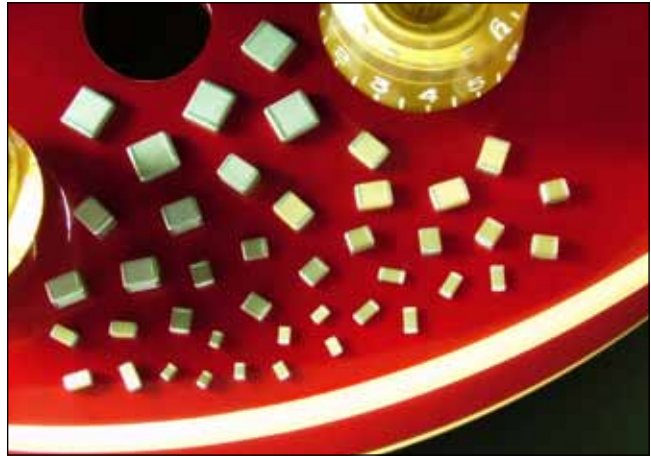

115Vac 400Hz capacitors - minimum/maximum capacitance values

	0805	1206	1210	1808	1812	2220
Dielectric	Maximum capacitance values					
COG/NP0	1pF - 330pF	1pF - 1.5nF	3.9pF - 3.9nF	4.7pF - 3.9nF	10pF - 10nF	10pF - 15nF
X7R	100pF - 4.7nF	100pF - 18nF	100pF - 39nF	100pF - 39nF	150pF - 82nF	220pF - 100nF

Ordering information - 115Vac 400Hz capacitors

1206	Y	A12	0103	J	X	T
Chip size	Termination	Voltage	Capacitance in picofarads (pF)	Capacitance tolerance	Dielectric codes	Packaging
0805 1206 1210 1808 1812 2220	<p>Y = FlexiCap™ termination base with nickel barrier (100% matte tin plating). RoHS compliant.</p> <p>H = FlexiCap™ termination base with nickel barrier (Tin/lead plating with min. 10% lead). Not RoHS compliant.</p> <p>J = Silver base with nickel barrier (100% matte tin plating). RoHS compliant.</p> <p>A = Silver base with nickel barrier (Tin/lead plating with min. 10% lead). Not RoHS compliant.</p>	A12 = 115Vac	<p>First digit is 0. Second and third digits are significant figures of capacitance code. The fourth digit is number of zeros following.</p> <p>Example: 0103 = 10nF</p>	<p><4.7pF H = ±0.05pF B = ±0.10pF C = ±0.25pF D = ±0.50pF</p> <p>≥4.7pF & <10pF B = ±0.10pF C = ±0.25pF D = ±0.50pF</p> <p>≥10pF F = ±1% G = ±2% J = ±5% K = ±10% M = ±20%</p>	<p>C = COG/NP0 X = X7R</p>	<p>T = 178mm (7") reel R = 330mm (13") reel B = Bulk pack - tubs or trays</p>



DWV chip range - COG/NPO, X7R

High Dielectric Withstand Voltage capacitors (DWV range)

The DWV range is specifically designed for use in applications where a high Dielectric Withstand Voltage (DWV) is required.

These parts have a continuous rated voltage of 500Vdc minimum and are 100% DWV tested at the specified voltages to ensure Flashover (arcing) across the surface does not occur.

- High dielectric withstand voltages (DWV) of 1.5kV and 2.5kV
- These ratings are based on an application of the DWV voltage for a period of up to 60 seconds (where the charging current is limited to 50mA)
- Case sizes: 1206, 1210, 1808, 1812, 2220 and 2225
- COG/NPO and X7R dielectrics
- Capacitance values from 4.7pF to 120nF
- For full range information please see Syfer web site, or contact the Sales Office.



DWV capacitors - minimum/maximum capacitance range

		1206	1210	1808	1812	2220	2225
1.5kV	COG/NPO	4.7pF - 330pF	4.7pF - 1nF	4.7pF - 1.2nF	10pF - 2.2nF	100pF - 4.7nF	100pF - 5.6nF
	X7R	4.7pF - 3.9nF	4.7pF - 10nF	4.7pF - 12nF	10pF - 33nF	100pF - 100nF	100pF - 120nF
2.5kV	COG/NPO	4.7pF - 220pF	4.7pF - 560nF	4.7pF - 1nF	10pF - 1.5nF	100pF - 3.3nF	100pF - 3.9nF
	X7R	4.7pF - 1nF	4.7pF - 2.2nF	4.7pF - 2.7nF	10pF - 5.6nF	10pF - 15nF	100pF - 18nF

Ordering information - DWV capacitors

1812	J	1K5	0820	K	C	T	DWV
Chip size	Termination	Dielectric Withstand Voltage	Capacitance in picofarads (pF)	Capacitance tolerance	Dielectric codes	Packaging	Suffix code
1206 1210 1808 1812 2220 2225	Y = FlexiCap™ termination base with nickel barrier (100% matte tin plating). RoHS compliant. J = Silver base with nickel barrier (100% matte tin plating). RoHS compliant.	1K5 = 1.5kV 2K5 = 2.5kV	First digit is 0. Second and third digits are significant figures of capacitance code. The fourth digit is number of zeros following. Example: 0820 = 82pF	<10pF B = ±0.10pF C = ±0.25pF D = ±0.50pF ≥10pF F = ±1% G = ±2% ≥10pF J = ±5% K = ±10% M = ±20%	C = COG/NPO X = X7R	T = 178mm (7") reel R = 330mm (13") reel B = Bulk pack - tubs or trays	Dielectric Withstand Voltage



High Temperature capacitors - X8R

The X8R dielectric will operate from -55°C to +150°C, with a maximum capacitance change ±15% (without applied voltage).

The devices are available in sizes 0805 to 2225, with voltage ranges from 25V to 3kV and capacitance values from 270pF to 1.8µF.

The capacitors have been developed by Syfer to meet demand from various applications in the automotive and industrial markets and in other electronic equipment exposed to high temperatures. The increased use of electronics in automotive "under the hood" applications has created demand for this product range.

The X8R range incorporates a specially formulated termination with a nickel barrier finish that has been designed to enhance the mechanical performance of these SMD chip capacitors in harsh environments typically present in automotive applications.

For information, X8R dielectric contains lead within the ceramic and parts rated less than 250Vdc are not compliant with the EU 2011/65/ EU RoHS directive.

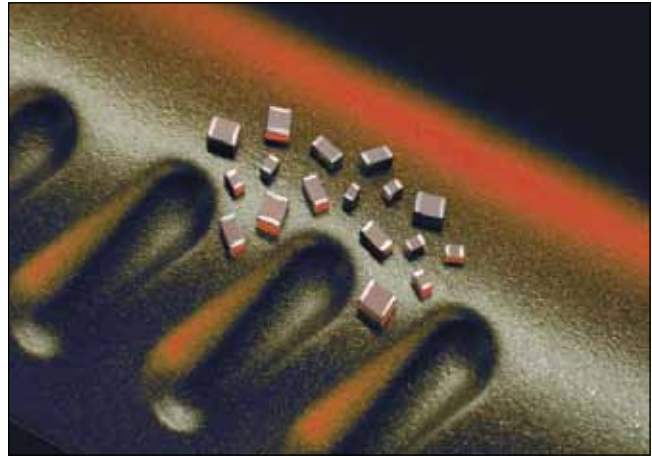

Capacitance Range

270pF to 1.8µF

Temperature Coefficient of Capacitance (TCC)

±15% from -55°C to +150°C

Dissipation Factor (DF)

≤ 0.025

Insulation Resistance (IR)

100G Ω or 1000secs (whichever is the less).

Dielectric Withstand Voltage (DWV)

2.5 x rated voltage for 5±1 seconds, 50mA charging current maximum.

Ageing Rate

1% per decade (typical)

X8R High Temperature capacitors - minimum/maximum cap. values according to the rated d.c. voltage

	0805	1206	1210	1808	1812	2220	2225
Minimum capacitance value	680pF	270pF	680pF	390pF	1nF	2.7nF	3.9nF
Maximum capacitance value according to the rated dc voltage	25V	56nF	180nF	330nF	470nF	680nF	1.5µF
	50V	33nF	120nF	220nF	270nF	470nF	680nF
	100V	15nF	56nF	120nF	150nF	220nF	470nF
	200/250V	10nF	33nF	68nF	82nF	120nF	220nF
	500V	3.9nF	18nF	39nF	47nF	100nF	180nF
	630V	1.8nF	3.9nF	10nF	12nF	33nF	150nF
	1kV	1nF	2.2nF	4.7nF	5.6nF	18nF	39nF
	1.2kV	-	1.8nF	3.9nF	4.7nF	12nF	33nF
	1.5kV	-	1.2nF	2.2nF	2.7nF	8.2nF	22nF
	2kV	-	470pF	1.2nF	1.8nF	4.7nF	12nF
	2.5kV	-	-	-	1nF	2.7nF	6.8nF
3kV	-	-	-	680pF	2.2nF	4.7nF	

■ = X8R ranges in yellow available as qualified AEC-Q200.

Ordering information - X8R High Temperature capacitors

1206	Y	100	0473	K	N	T
Chip size	Termination	Voltage d.c.	Capacitance in picofarads (pF)	Capacitance tolerance	Dielectric codes	Packaging
0805 1206 1210 1808 1812 2220 2225	Y = FlexiCap™ termination base with nickel barrier (100% matte tin plating). RoHS compliant.	025 = 25V 050 = 50V 100 = 100V 200 = 200V 250 = 250V 500 = 500V 630 = 630V 1K0 = 1kV 1K2 = 1.2kV 1K5 = 1.5kV 2K0 = 2kV 2K5 = 2.5kV 3K0 = 3kV	First digit is 0. Second and third digits are significant figures of capacitance code. The fourth digit is number of zeros following. Example: 0473 = 47000pF = 47nF	J = ±5% K = ±10% M = ±20%	N = X8R T = X8R AEC-Q200	T = 178mm (7") reel R = 330mm (13") reel B = Bulk pack - tubs or trays

Surface mount EMI Filters - E01 & E07 feedthrough capacitors

The Syfer E01 and E07 ranges of feedthrough MLCC chip 'C' filters are 3 terminal chip devices designed to offer reduced inductance compared to conventional MLCCs when used in signal line filtering.

The filtered signal passes through the chip internal electrodes and the noise is filtered to the grounded side contacts, resulting in reduced length noise transmission paths.

Available in COG/NPO and X7R dielectrics, with current ratings of 300mA, 1A, 2A, 3A and voltage ratings of 25Vdc to 200Vdc. Also available with FlexiCap™ termination which is strongly recommended for new designs.

Commonly used in automotive applications, a range qualified to AECQ-200 is also available.

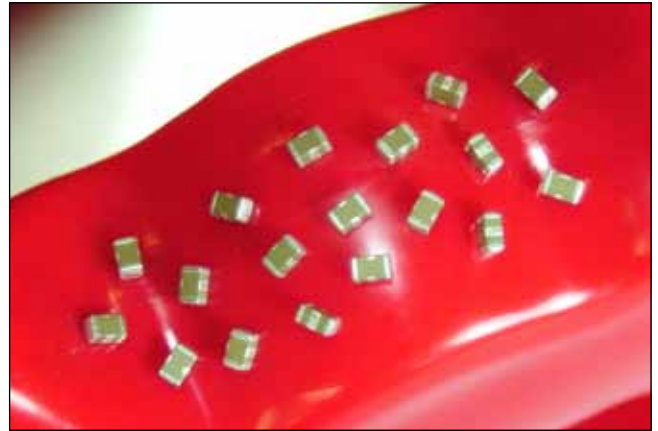

E01 300mA, E07 1A/2A/3A

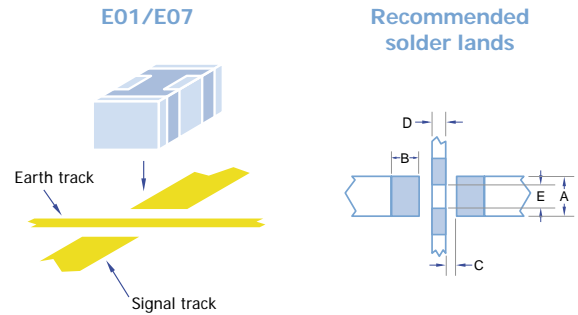
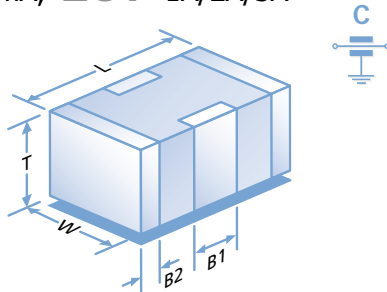

Dimensions

	0805	1206	1806	1812
L	2.0 ± 0.3 (0.079 ± 0.012)	3.2 ± 0.3 (0.126 ± 0.012)	4.5 ± 0.35 (0.177 ± 0.014)	4.5 ± 0.35 (0.177 ± 0.014)
W	1.25 ± 0.2 (0.049 ± 0.008)	1.6 ± 0.2 (0.063 ± 0.008)	1.6 ± 0.2 (0.063 ± 0.008)	3.2 ± 0.3 (0.126 ± 0.012)
T	1.0 ± 0.15 (0.039 ± 0.006)	1.1 ± 0.2 (0.043 ± 0.008)	1.1 ± 0.2 (0.043 ± 0.008)	2.0 ± 0.3 (0.079 ± 0.012)
B1	0.60 ± 0.2 (0.024 ± 0.008)	0.95 ± 0.3 (0.037 ± 0.012)	1.4 ± 0.3 (0.055 ± 0.012)	1.45 ± 0.35 (0.055 ± 0.012)
B2	0.3 ± 0.15 (0.012 ± 0.006)	0.5 ± 0.25 (0.02 ± 0.01)	0.5 ± 0.25 (0.02 ± 0.01)	0.75 ± 0.25 (0.02 ± 0.01)

	0805	1206	1806	1812
A	0.95 (0.037)	1.20 (0.047)	1.2 (0.047)	2.65 (0.104)
B	0.90 (0.035)	0.90 (0.035)	1.40 (0.055)	1.40 (0.055)
C	0.30 (0.012)	0.60 (0.024)	0.80 (0.031)	0.80 (0.031)
D	0.40 (0.016)	0.80 (0.031)	1.40 (0.055)	1.40 (0.055)
E	0.75 (0.030)	1.0 (0.039)	1.0 (0.039)	2.05 (0.080)

Notes: 1) All dimensions mm (inches).

2) Pad widths less than chip width gives improved mechanical performance.

3) The solder stencil should place 4 discrete solder pads. The unprinted distance between ground pads is shown as dim E.

4) Insulating the earth track underneath the filters is acceptable and can help avoid displacement of filter during soldering but can result in residue entrapment under the chip.

Standard Range - E01 & E07 Feedthrough Capacitors

Type		E01			E07			
Chip Size		0805	1206	1806	0805	1206	1806	1812
Max Current		300mA	300mA	300mA	1A	2A	2A	3A
Rated Voltage	Dielectric	Minimum and maximum capacitance values						
25Vdc	COG/NPO	180pF-1.5nF	560pF-3.9nF	820pF-4.7nF	180pF-1.5nF	560pF-3.9nF	820pF-4.7nF	-
	X7R	470pF-100nF	5.6nF-330nF	3.9nF-560nF	820pF-100nF	10nF-330nF	22nF-560nF	560nF-1.8µF
50Vdc	COG/NPO	22pF-820pF	22pF-3.3nF	22pF-3.9nF	10pF-220pF	22pF-1nF	100pF-1.5nF	-
	X7R	560pF-68nF	4.7nF-220nF	3.3nF-330nF	1nF-68nF	10nF-220nF	22nF-330nF	330nF-1.5µF
100Vdc	COG/NPO	22pF-560pF	22pF-2.2nF	22pF-3.3nF	10pF-120pF	22pF-560pF	100pF-680pF	-
	X7R	560pF-27nF	1.8nF-100nF	3.3nF-180nF	1nF-27nF	10nF-100nF	22nF-180nF	180nF-820nF
200Vdc	COG/NPO	-	560pF-1.2nF	56pF-1nF	-	15pF-180pF	56pF-470pF	-
	X7R	-	2.7nF-56nF	3.9nF-100nF	-	12nF-56nF	22nF-100nF	100nF-270nF

Note: E07 25Vdc COG/NPO 1206 and 1806 ranges in green, have maximum current of 1A.

AEC-Q200 Qualified Range - E01 & E07 Feedthrough Capacitors - maximum capacitance values

Type		E01			E07		
Chip Size		0805	1206	1806	0805	1206	1806
50V	COG/NPO	820pF	1nF	2.2nF	220pF	1nF	1.5nF
	X7R	47nF	100nF	200nF	47nF	100nF	200nF
100V	COG/NPO	560pF	1nF	2.2nF	120pF	560pF	680pF
	X7R	15nF	15nF	68nF	15nF	15nF	68nF

Note: For some lower capacitance parts, higher voltage rated parts may be supplied. Please refer to the table below.

Surface mount EMI Filters - E01 & E07 feedthrough capacitors

Open board insertion loss performance in 50Ω system

Open Board Performance						
Capacitance	0.1MHz	1MHz	10MHz	100MHz	1GHz	Resonance Freq (MHz) approx.
10pF	0	0	0	0	7.5	2200
22pF	0	0	0	0	16	1600
33pF	0	0	0	1	22	1350
47pF	0	0	0	2	28	1150
68pF	0	0	0	3	41	900
100pF	0	0	0	5	28	800
150pF	0	0	0	8	24	700
220pF	0	0	0	12	20	600
330pF	0	0	1	15	20	500
470pF	0	0	2	18	20	425
560pF	0	0	3	20	20	350
680pF	0	0	4	22	20	300
820pF	0	0	5	24	20	260
1nF	0	0	7	27	20	220
1.5nF	0	0	9	31	20	200
2.2nF	0	0	12	34	20	170
3.3nF	0	1	14	39	20	135
4.7nF	0	2	18	46	20	110
6.8nF	0	3	21	50	20	90
10nF	0	5	24	48	20	80
15nF	0	8	27	45	20	65
22nF	0	12	31	43	20	56
33nF	1	14	34	40	20	40
47nF	2	17	38	40	20	34
68nF	4	20	41	40	20	30
100nF	6	24	45	40	20	28
150nF	8	26	48	40	20	24
220nF	10	30	52	40	20	17
330nF	13	33	55	40	20	15.5
470nF	16	36	60	40	20	14
560nF	18	39	65	40	20	12

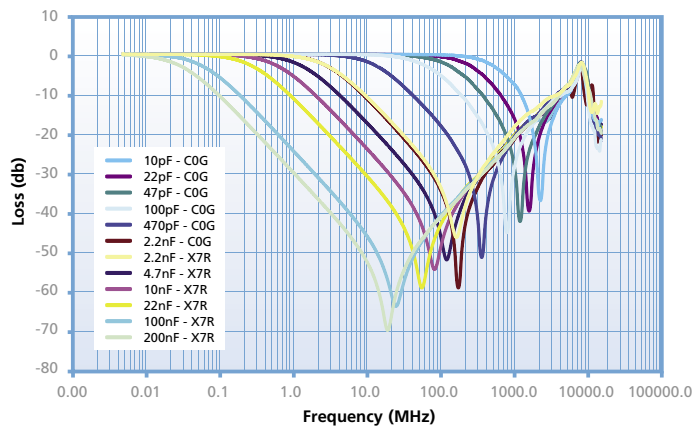

Ordering Information - E01 & E07 feedthrough capacitors

1206	Y	100	0103	M	X	T	E07
Chip Size	Termination	Voltage	Capacitance in picofarads (pF)	Tolerance	Dielectric	Packaging	Type
0805 1206 1806	J = Nickel Barrier (Tin) *Y = FlexiCap™ (Tin - X7R only) A = (Tin/Lead) Not RoHS compliant. *H = FlexiCap™ (Tin/Lead) Not RoHS compliant.	025 = 25V 050 = 50V 100 = 100V 200 = 200V	First digit is 0. Second and third digits are significant figures of capacitance code. The fourth digit is number of zeros following Example: 0103 = 10000pF.	M = ±20%	A = COG/NP0 AEC-Q200 C = COG/NP0 E = X7R AEC-Q200 X = X7R	T = 178mm (7") reel R = 330mm (13") reel B = Bulk	E01 E07

Note: *FlexiCap™ termination only available in X7R material. Please contact our Sales Office for any special requirements.

Reeled quantities

178mm (7") reel	0805 3000	1206 2500	1806 2500	330mm (13") reel	0805 12000	1206 10000	1806 10000
-----------------	--------------	--------------	--------------	------------------	---------------	---------------	---------------

Surface mount EMI Filters - E03 X2Y Integrated Passive Components

The Syfer X2Y Integrated Passive Component is a 3 terminal EMI chip device.

When used in balanced line applications, the revolutionary design provides simultaneous line-to-line and line-to-ground filtering, using a single ceramic chip. In this way, differential and common mode filtering are provided in one device.

For unbalanced applications, it provides ultra low ESL (equivalent series inductance). Capable of replacing 2 or more conventional devices, it is ideal for balanced and unbalanced lines, twisted pairs and dc motors, in automotive, audio, sensor and other applications.

Available in sizes from 0805 to 1812, these filters can prove invaluable in meeting stringent EMC demands.

Manufactured in the UK by Syfer Technology Limited under licence from X2Y Attenuators LLC.



Dielectric
X7R or COG/NPO

Electrical configuration
Multiple capacitance

Capacitance measurement
At 1000hr point

Typical capacitance matching
Better than 5%
(down to 1% available on request)

Temperature rating
-55°C to 125°C

Insulation resistance
100Gohms or 1000s (whichever is the less)

Dielectric withstand voltage
≤200V 2.5 times rated Volts for 5 secs
500V 1.5 times rated Volts for 5 secs
Charging current limited to 50mA Max.

Type		E03			
Chip size		0805	1206	1410	1812
Rated voltage	Dielectric				
16Vdc	COG/NPO	-	-	-	-
	X7R	-	-	-	-
25Vdc	COG/NPO	560pF - 820pF	1.8nF - 3.3nF	6.8nF - 8.2nF	12nF - 15nF
	X7R	56nF - 68nF	-	470nF	820nF
50Vdc	COG/NPO	390pF - 470pF	1.2nF - 1.5nF	4.7nF - 5.6nF	8.2nF - 10nF
	X7R	18nF - 47nF	56nF - 220nF	180nF - 400nF	390nF - 680nF
100Vdc	COG/NPO	10pF - 330pF	22pF - 1.0nF	100pF - 3.9nF	820pF - 6.8nF
	X7R	470pF - 15nF	1.5nF - 47nF	4.7nF - 150nF	8.2nF - 330nF
200Vdc	COG/NPO	-	22pF - 1.0nF	100pF - 3.3nF	820pF - 5.6nF
	X7R	-	820pF - 33nF	1.2nF - 120nF	2.7nF - 180nF
500Vdc	COG/NPO	-	-	-	820pF - 3.9nF
	X7R	-	-	-	2.7nF - 100nF

Notes: 1) For some lower capacitance parts, higher voltage rated parts may be supplied.

AEC-Q200 range (E03) - capacitance values

Chip size		0805	1206	1410	1812
50Vdc	COG/NPO	390pF - 470pF	1.2nF - 1.5nF	4.7nF - 5.6nF	8.2nF - 10nF
	X7R	18nF - 33nF	56nF - 150nF	180nF - 330nF	390nF - 560nF
100Vdc	COG/NPO	10pF - 330pF	22pF - 1.0nF	100pF - 3.9nF	820pF - 6.8nF
	X7R	470pF - 15nF	1.5nF - 47nF	4.7nF - 150nF	8.2nF - 330nF

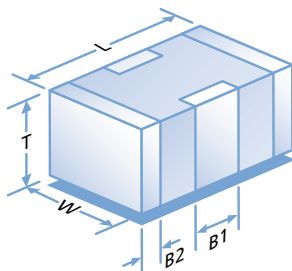

	0805	1206	1410	1812
L	2.0±0.3 (0.08±0.012)	3.2±0.3 (0.126±0.012)	3.6±0.3 (0.14±0.012)	4.5±0.35 (0.18±0.014)
W	1.25±0.2 (0.05±0.008)	1.60±0.2 (0.063±0.008)	2.5±0.3 (0.1±0.012)	3.2±0.3 (0.126±0.012)
T	1.0±0.15 (0.04±0.006)	1.1±0.2 (0.043±0.008)	2.0 max. (0.08 max.)	2.1 max. (0.08 max.)
B1	0.5±0.25 (0.02±0.01)	0.95±0.3 (0.037±0.012)	1.20±0.3 (0.047±0.012)	1.4±0.35 (0.06±0.014)
B2	0.3±0.15 (0.012±0.006)	0.5±0.25 (0.02±0.01)	0.5±0.25 (0.02±0.01)	0.75±0.25 (0.03±0.01)

Notes: 1) All dimensions mm (inches).

2) Pad widths less than chip width gives improved mechanical performance.

3) The solder stencil should place 4 discrete solder pads. The un-printed distance between ground pads is shown as dim E.

4) Insulating the earth track underneath the filters is acceptable and can help avoid displacement of filter during soldering but can result in residue entrapment under the chip.

Surface mount EMI Filters - E03 X2Y Integrated Passive Components

Recommended solder lands

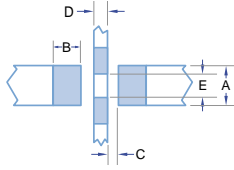

	0805	1206	1410	1812
A	0.95 (0.037)	1.2 (0.047)	2.05 (0.08)	2.65 (0.104)
B	0.9 (0.035)	0.9 (0.035)	1.0 (0.040)	1.4 (0.055)
C	0.3 (0.012)	0.6 (0.024)	0.7 (0.028)	0.8 (0.031)
D	0.4 (0.016)	0.8 (0.031)	0.9 (0.035)	1.4 (0.055)
E	0.75 (0.030)	1.0 (0.039)	1.85 (0.071)	2.05 (0.080)

Component	Advantages	Disadvantages	Applications
Chip capacitor	Industry standard	Requires 1 per line High inductance Capacitance matching problems	By-pass Low frequency
3 terminal feedthrough	Feedthrough Lower inductance	Current limited	Feedthrough Unbalanced lines High frequency
Syfer X2Y Integrated Passive Component	Very low inductance Replaces 2 (or 3) components Negates the effects of temperature, voltage and ageing Provides both common mode and differential mode attenuation Can be used on balanced & unbalanced lines	Care must be taken to optimise circuit design	By-pass Balanced lines High frequency dc electric motors Unbalanced lines Audio amplifiers CANBUS

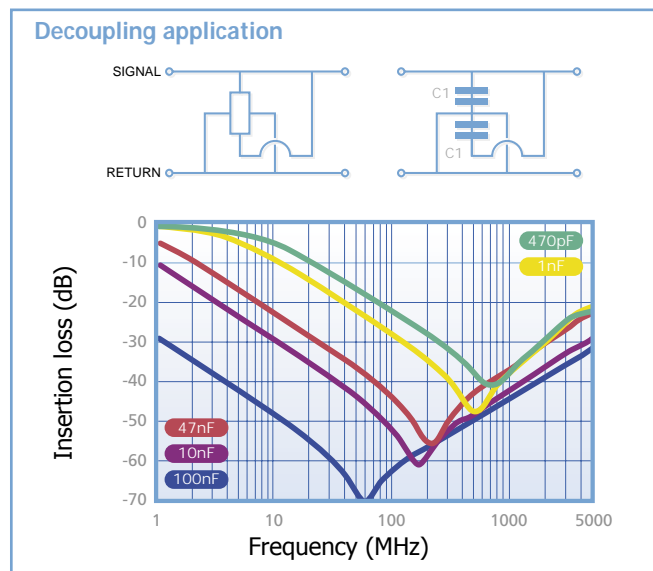
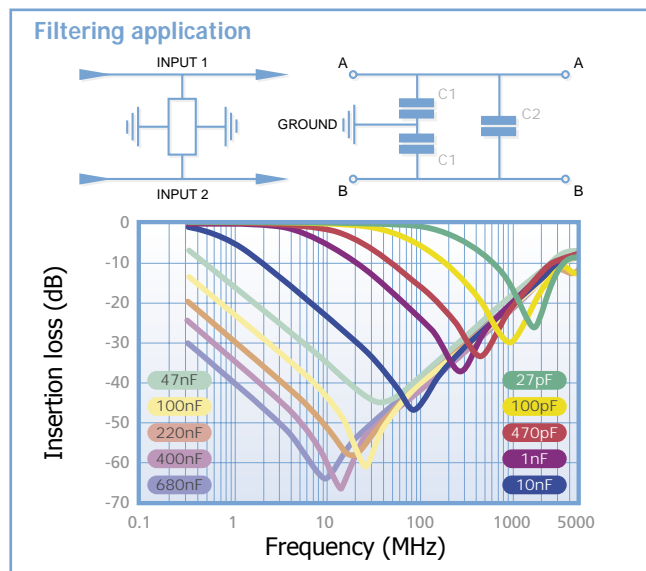

Ordering Information - X2Y IPC range

1812	Y	100	0334	M	X	T	E03
Chip Size	Termination	Voltage	Capacitance in picofarads (pF) C ₁	Tolerance	Dielectric	Packaging	Type
0805 1206 1410 1812	J = Nickel Barrier (Tin) *Y = FlexiCap™ (Tin - X7R only) A = (Tin/Lead) Not RoHS compliant. *H = FlexiCap™ (Tin/Lead) Not RoHS compliant.	016 = 16V 025 = 25V 050 = 50V 100 = 100V 200 = 200V 500 = 500V	First digit is 0. Second and third digits are significant figures of capacitance code. The fourth digit is number of zeros following Example: 0334=330nF. Note: C ₁ = 2C ₂	M = ±20% (Tighter tolerances may be available on request).	A = COG/NPO AEC-Q200 C = COG/NPO E = X7R AEC-Q200 X = X7R	T = 178mm (7") reel R = 330mm (13") reel B = Bulk	Syfer X2Y Integrated Passive Component

Note: *FlexiCap™ termination only available in X7R material. Please contact the sales office for any special requirements.

Reeled quantities

178mm (7") reel	0805	1206	1410	1812
	3000	2500	2000	1000

330mm (13") reel	0805	1206	1410	1812
	12000	10000	8000	4000

Ceramic chip capacitors - Packaging information

Tape and reel packing of surface mounting chip capacitors for automatic placement are in accordance with IEC60286-3.

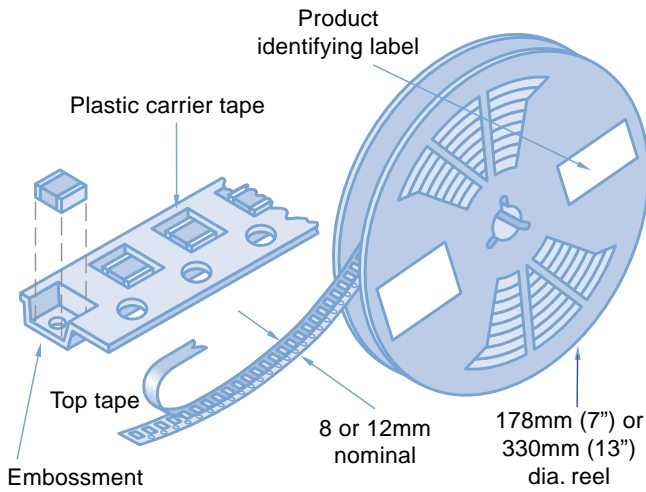

Peel force

The peel force of the top sealing tape is between 0.2 and 1.0 Newton at 180°. The breaking force of the carrier and sealing tape in the direction of unreeling is greater than 10 Newtons.

Reel dimensions mm (inches)

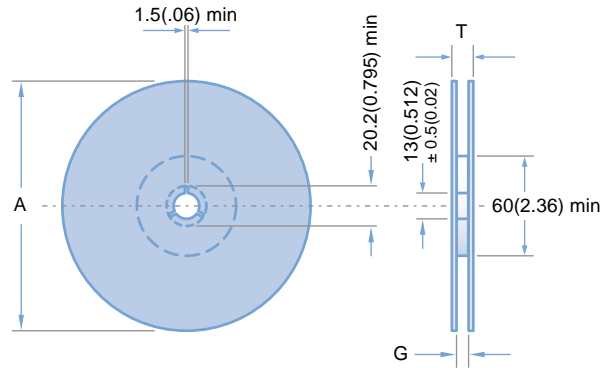

Symbol	Description	178mm reel	330mm reel
A	Reel diameter	178 (7)	330 (13)
G	Reel inside width	8.4 (0.33)	12.4 (0.49)
T	Reel outside width	14.4 (0.56) max	18.4 (0.72) max

Tape dimensions

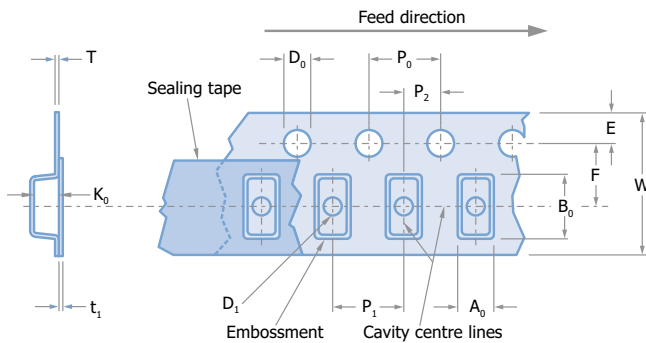

Symbol	Description	Dimensions mm (inches)	
		8mm tape	12mm tape
A ₀	Width of cavity	Dependent on chip size to minimize rotation	
B ₀	Length of cavity	Dependent on chip size to minimize rotation	
K ₀	Depth of cavity	Dependent on chip size to minimize rotation	
W	Width of tape	8.0 (0.315)	12.0 (0.472)
F	Distance between drive hole centres and cavity centres	3.5 (0.138)	5.5 (0.213)
E	Distance between drive hole centres and tape edge	1.75 (0.069)	
P ₁	Distance between cavity centres	4.0 (0.156)	8.0 (0.315)
P ₂	Axial distance between drive hole centres and cavity centres	2.0 (0.079)	
P ₀	Axial distance between drive hole centres	4.0 (0.156)	
D ₀	Drive hole diameter	1.5 (0.059)	
D ₁	Diameter of cavity piercing	1.0 (0.039)	1.5 (0.059)
T	Carrier tape thickness	0.3 (0.012) ± 0.1 (0.004)	0.4 (0.016) ± 0.1 (0.004)
t ₁	Top tape thickness	0.1 (0.004) max	

Ceramic Chip Capacitors - Packaging Information

Missing components

The number of missing components in the tape may not exceed 0.25% of the total quantity with not more than three consecutive components missing. This must be followed by at least six properly placed components.

Identification

Each reel is labelled with the following information: manufacturer, chip size, capacitance, tolerance, rated voltage, dielectric type, batch number, date code and quantity of components.

Leader and Trailer

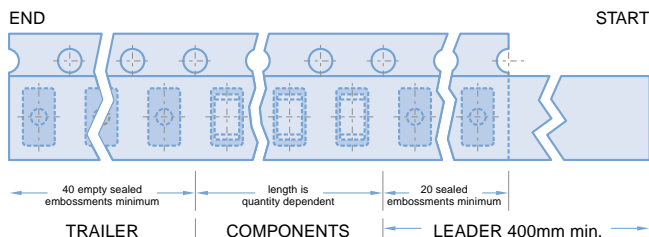

Component orientation

Tape and reeling is in accordance with IEC 60286 part 3, which defines the packaging specifications of leadless components on continuous tapes.

- Notes: 1) IEC60286-3 states $A_o \leq B_o$ (see tape dimensions on page 48).
 2) Regarding the orientation of 1825 and 2225 components, the termination bands are right to left, NOT front to back. Please see diagram.

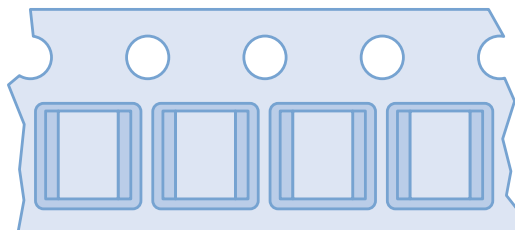

Orientation of 1825 & 2225 components

Outer Packaging

Outer carton dimensions mm (inches) max.

Reel Size	No. of reels	L	W	T
178 (7.0)	1	185 (7.28)	185 (7.28)	25 (0.98)
178 (7.0)	4	190 (7.48)	195 (7.76)	75 (2.95)
330 (13.0)	1	335 (13.19)	335 (13.19)	25 (0.98)

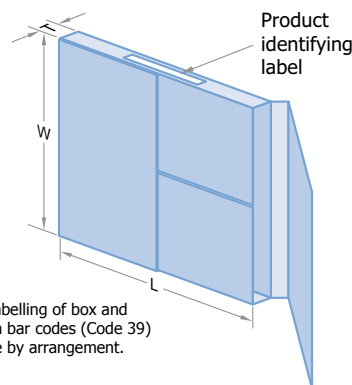

Reel quantities

Chip size	0402	0505	0603	0805	1111	1206	1210	1410	1808	1812	1825	2211	2215	2220	2225
Max. chip thickness	0.5mm	1.3mm	0.8mm	1.3mm	1.8mm	1.6mm	2.0mm	2.0mm	2.0mm	2.5mm	2.5mm	2.5mm	2.5mm	2.5mm	2.5mm
	0.02"	0.05"	0.03"	0.05"	0.07"	0.06"	0.08"	0.08"	0.08"	0.1"	0.1"	0.1"	0.1"	0.1"	0.1"
Reel quantities	178mm (7")	10000	2500	4000	3000	1000	2500	2000	2000	1500	500/1000	500	750	500	500/1000
	330mm (13")	-	-	16000	12000	-	10000	8000	8000	6000	2000/4000	2000	-	4000	2000/4000

Notes:

- 1) The above quantities per reel are for the maximum manufactured chip thickness. Thinner chips can be taped in larger quantities per reel.
 2) Where two different quantities are shown for the same case size, please contact the Sales Office to determine the exact quantity for any specific part number.

Bulk packing - tubs

Chips are supplied in rigid re-sealable plastic tubs together with impact cushioning wadding. Tubs are labelled with the details: chip size, capacitance, tolerance, rated voltage, dielectric type, batch number, date code and quantity of components.

Dimensions mm (inches)

H	60 (2.36)
D	50 (1.97)

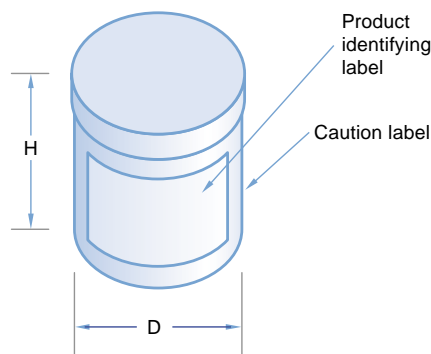

Radial Leaded Capacitors - COG/NP0, X7R

Syfer Technology produces a wide range of dipped radial leaded capacitors. These are available in rated voltages of 50V up to 6kV. Although our catalogue range extends to 6kV, we are able to offer a capability for specials up to 12kV. Our larger case sizes and high voltage versions are particularly in demand, especially for mil/aero and medical power supply applications. Please contact our Sales Office to discuss any special requirements.

- High working voltage - up to 12kVdc
- Large case sizes
- RoHS compliant versions
- Tin-lead plated wire option to reduce tin whiskers (quote suffix A97 for 8111 to 8141 & A31 for 8151, 8161, 8171).



		8111M	8111N	8121M	8121N	8121T	8131M	8131M T = 6.3mm	8131T	8141M	8151M	8151M T = 6.3mm	8161M	8161M T = 7.0mm	8171M	8171M T = 7.0mm
Min. cap values	COG/NP0	4.7pF	4.7pF	4.7pF	4.7pF	4.7pF	4.7pF	-	10pF	4.7pF	10pF	-	27pF	-	47pF	-
	X7R	100pF	100pF	100pF	100pF	330pF	100pF	-	150pF	100pF	470pF	-	1.0nF	-	1.8nF	-
50/63V	COG/NP0	5.6nF	5.6nF	33nF	33nF	33nF	220nF	-	100nF	220nF	330nF	-	680nF	-	1.0µF	-
	X7R	220nF	220nF	1.0µF	1.0µF	1.0µF	3.3µF	-	2.2µF	4.7µF	10µF	-	15µF	-	22µF	-
100V	COG/NP0	2.2nF	2.2nF	18nF	18nF	18nF	82nF	-	47nF	82nF	270nF	-	470nF	-	680nF	-
	X7R	100nF	100nF	680nF	680nF	680nF	2.7µF	-	1.5µF	2.7µF	5.6µF	-	10µF	-	15µF	-
200/ 250V	COG/NP0	1.0nF	1.0nF	8.2nF	8.2nF	8.2nF	47nF	68nF	22nF	47nF	120nF	180nF	270nF	330nF	390nF	560nF
	X7R	56nF	56nF	330nF	330nF	330nF	1.5µF	-	680nF	1.5µF	3.3µF	-	5.6µF	-	10µF	-
500V	COG/NP0	680pF	680pF	6.8nF	6.8nF	6.8nF	33nF	47nF	15nF	33nF	82nF	120nF	180nF	270nF	270nF	470nF
	X7R	15nF	15nF	150nF	150nF	150nF	820nF	-	330nF	820nF	1.0µF	-	1.8µF	-	3.3µF	-
630V	COG/NP0	560pF	560pF	3.9nF	3.9nF	3.9nF	22nF	39nF	10nF	22nF	68nF	100nF	120nF	180nF	220nF	390nF
	X7R	12nF	12nF	100nF	100nF	100nF	390nF	-	180nF	470nF	680nF	-	1.2µF	-	2.2µF	-
1kV	COG/NP0	180pF	180pF	2.2nF	2.2nF	2.2nF	18nF	27nF	6.8nF	18nF	47nF	82nF	82nF	150nF	150nF	270nF
	X7R	10nF	10nF	47nF	47nF	47nF	150nF	-	100nF	150nF	180nF	-	390nF	-	1.0µF	-
1.2kV	COG/NP0	120pF	120pF	1.5nF	1.5nF	1.5nF	12nF	22nF	4.7nF	12nF	33nF	56nF	68nF	100nF	100nF	180nF
	X7R	-	-	10nF	10nF	10nF	100nF	-	33nF	100nF	150nF	-	220nF	-	470nF	-
1.5kV	COG/NP0	82pF	82pF	820pF	820pF	820pF	6.8nF	12nF	2.7nF	6.8nF	22nF	39nF	39nF	68nF	68nF	120nF
	X7R	-	-	6.8nF	6.8nF	6.8nF	68nF	-	22nF	68nF	100nF	-	150nF	-	330nF	-
2kV	COG/NP0	39pF	39pF	390pF	390pF	390pF	4.7nF	6.8nF	1.5nF	4.7nF	10nF	18nF	22nF	39nF	39nF	68nF
	X7R	-	-	4.7nF	4.7nF	4.7nF	33nF	-	10nF	47nF	47nF	-	82nF	-	150nF	-
2.5kV	COG/NP0	-	-	220pF	220pF	220pF	2.2nF	3.9nF	820pF	2.2nF	6.8nF	12nF	12nF	22nF	22nF	39nF
	X7R	-	-	-	-	-	12nF	-	3.3nF	12nF	33nF	-	68nF	-	100nF	-
3kV	COG/NP0	-	-	150pF	150pF	150pF	1.8nF	2.7nF	560pF	1.8nF	4.7nF	8.2nF	10nF	18nF	15nF	27nF
	X7R	-	-	-	-	-	8.2nF	-	2.7nF	10nF	22nF	-	47nF	-	82nF	-
4kV	COG/NP0	-	-	-	-	-	820pF	1.5nF	270pF	820pF	1.8nF	3.3nF	4.7nF	6.8nF	8.2nF	15nF
	X7R	-	-	-	-	-	5.6nF	-	2.2nF	5.6nF	6.8nF	-	15nF	-	33nF	-
5kV	COG/NP0	-	-	-	-	-	560pF	1.0nF	180pF	560pF	1.5nF	2.2nF	2.7nF	4.7nF	5.6nF	10nF
	X7R	-	-	-	-	-	4.7nF	-	1.2nF	4.7nF	5.6nF	-	10nF	-	22nF	-
6kV	COG/NP0	-	-	-	-	-	390pF	680pF	120pF	390pF	1.0nF	1.5nF	1.8nF	3.3nF	3.9nF	6.8nF
	X7R	-	-	-	-	-	2.7nF	-	1.0nF	2.7nF	4.7nF	-	8.2nF	-	15nF	-
8kV	COG/NP0	-	-	-	-	-	-	-	-	-	150pF	-	330pF	-	680pF	-
	X7R	-	-	-	-	-	-	-	-	-	1.5nF	-	4.7nF	-	6.8nF	-
10kV	COG/NP0	-	-	-	-	-	-	-	-	-	100pF	-	180pF	-	470pF	-
	X7R	-	-	-	-	-	-	-	-	-	1.0nF	-	2.2nF	-	4.7nF	-
12kV	COG/NP0	-	-	-	-	-	-	-	-	-	68pF	-	120pF	-	220pF	-
	X7R	-	-	-	-	-	-	-	-	-	820pF	-	1.2nF	-	2.2nF	-

Note: T = Maximum thickness.

Radial Leaded Capacitors - Packaging information

Dimensions - Radial Leaded capacitors

		Width	Height	Thickness	Lead Space	Lead Diameter
	Pattern	(X) max. mm (inches)	(Y) max. mm (inches)	(Z) max. mm (inches)	(S) mm (inches)	(d) mm (inches)
8111M	A	3.81 (0.15)	5.31 (0.21)	2.54 (0.10)	2.54 ±0.4 (0.1 ±0.016)	0.5 ±0.05 (0.02 ±0.002)
8111N	B	3.81 (0.15)	5.31 (0.21)	2.54 (0.10)	5.08 ±0.4 (0.2 ±0.016)	0.5 ±0.05 (0.02 ±0.002)
8121M	A	5.08 (0.20)	6.58 (0.26)	3.18 (0.125)	2.54 ±0.4 (0.1 ±0.016)	0.5 ±0.05 (0.02 ±0.002)
8121N	B	5.08 (0.20)	6.58 (0.26)	3.18 (0.125)	5.08 ±0.4 (0.2 ±0.016)	0.5 ±0.05 (0.02 ±0.002)
8121T	B	10.16 (0.40)	5.80 (0.23)	4.50 (0.18)	7.62 ±0.4 (0.30 ±0.016)	0.5 ±0.05 (0.02 ±0.002)
8131M	A	7.62 (0.30)	9.12 (0.36)	3.81/6.30 (0.15/0.25)	5.08 ±0.4 (0.2 ±0.016)	0.5 ±0.05 (0.02 ±0.002)
8131T	B	10.16 (0.40)	9.12 (0.36)	4.50 (0.18)	7.62 ±0.4 (0.30 ±0.016)	0.5 ±0.05 (0.02 ±0.002)
8141M	A	10.16 (0.40)	11.66 (0.46)	3.81 (0.15)	5.08 ±0.4 (0.2 ±0.016)	0.5 ±0.05 (0.02 ±0.002)
8151M	A	12.70 (0.50)	14.20 (0.56)	5.08/6.30 (0.20/0.25)	10.1 ±0.4 (0.4 ±0.016)	0.6 ±0.05 (0.025 ±0.002)
8161M	A	18.50 (0.73)	16.50 (0.65)	6.00/7.00 (0.24/0.28)	14.5 ±0.5 (0.57 ±0.02)	0.6 ±0.05 (0.025 ±0.002)
8165M	A	19.00 (0.75)	19.00 (0.75)	4.25 (0.17)	17.5 ±0.5 (0.67 ±0.02)	0.6 ±0.05 (0.025 ±0.002)
8171M	A	25.00 (0.98)	20.00 (0.79)	6.00/7.00 (0.24/0.28)	21.0 ±0.6 (0.83 ±0.024)	0.6 ±0.05 (0.025 ±0.002)

Marking information

All encapsulated capacitors are marked with:- Capacitance value, tolerance, rated d.c. voltage, dielectric, and where size permits the Syfer Technology 'S' logo.

Example: 1000pF ±10% 50V 2X1 dielectric

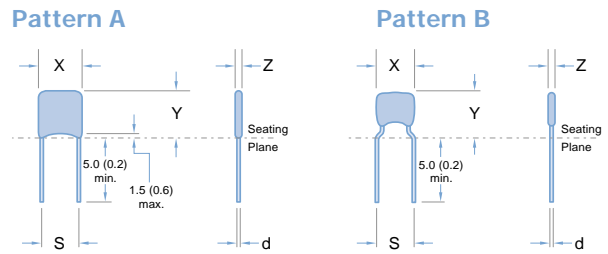
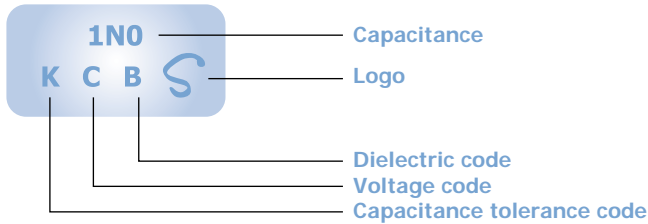

Note: Pattern A may be substituted with Pattern B at Syfer's discretion.

Ordering information - Radial Leaded capacitors

8111M	100	0102	J	C	□□□	□□□
Type No./ Size ref	Voltage d.c. (marking code)	Capacitance in picofarads (pF)	Capacitance tolerance	Dielectric Rel Release codes	Suffix code	Suffix code
8111M	050 = 50V (C)	<10pF	<10pF	C = C0G/NP0 (1B/CG; CG/BP)	Used for specific customer requirements.	C42 denotes RoHS compliant. A31 or A97 denote non-RoHS tin/lead wires.
8111N	063 = 63V (D)	Insert a P for the decimal point as the second character. eg. 8P20 = 8.2pF	D: ± 0.5pF F: ± 1.0pF	X = X7R (2R1)		
8121M	100 = 100V (E)	≥10pF	≥10pF	To Special Order	Suffix A97 for 8111 to 8141 & A31 for 8151, 8161, 8171.	
8121N	200 = 200V (F)	First digit is 0. Second and third digits are significant figures of capacitance code. Fourth digit is number of zeros eg. 0101 = 100pF	J: ± 5% K: ± 10% M: ± 20% G: ± 2% (C0G/NP0 only).	B = 2X1 (BX) R = 2C1 (BZ)		
8121T	250 = 250V (Q)					
8131M	500 = 500V					
8131T	630 = 630V					
8141M	1K0 = 1kV					
8151M	1K2 = 1.2kV					
8161M	1K5 = 1.5kV					
8165M	2K0 = 2kV					
8171M	2K5 = 2.5kV					
	3K0 = 3kV					
	4K0 = 4kV					
	5K0 = 5kV					
	6K0 = 6kV					
	8K0 = 8kV					
	10K = 10kV					
	12K = 12kV					

Notes: The voltage code may be replaced with the complete voltage (e.g. 1500V = 1K5V) at Syfer's discretion. Marking may be over both sides of the component as necessary.

Radial Leaded Capacitors - C0G/NP0 & X7R ranges

Capacitance	Code	8111M / 8111N		8121M / 8121N		8121T	
		C0G/NP0	X7R	C0G/NP0	X7R	C0G/NP0	X7R
		4.7pF	4p7				
5.6	5p6						
6.8	6p8						
8.2	8p2						
10pF	100						
12	120						
15	150						
18	180						
22	220						
27	270						
33	330						
39	390						
47	470						
56	560						
68	680						
82	820						
100pF	101						
120	121						
150	151						
180	181						
220	221						
270	271						
330	331						
390	391						
470	471						
560	561						
680	681						
820	821						
1.0nF	102						
1.2	122						
1.5	152						
1.8	182						
2.2	222						
2.7	272						
3.3	332						
3.9	392						
4.7	472						
5.6	562						
6.8	682						
8.2	822						
10nF	103						
12	123						
15	153						
18	183						
22	223						
27	273						
33	333						
39	393						
47	473						
56	563						
68	683						
82	823						
100nF	104						
120	124						
150	154						
180	184						
220	224						
270	274						
330	334						
390	394						
470	474						
560	564						
680	684						
820	824						
1.0μF	105						
1.2	125						
1.5	155						
1.8	185						
2.2	225						
2.7	275						
3.3	335						
3.9	395						
4.7	475						
5.6	565						
6.8	685						
8.2	825						
10μF	106						
12	126						
15μF	156						

Radial Leaded Capacitors - C0G/NP0 & X7R ranges

8131M		8131T		Capacitance	Code
C0G/NP0	X7R	C0G/NP0	X7R		
50V/63V	50V/63V	50V/63V	50V/63V	4.7pF	4p7
100V	100V	100V	100V	5.6	5p6
200V/250V	200V/250V	200V/250V	200V/250V	6.8	6p8
500V	500V	500V	500V	8.2	8p2
1kV	1kV	1kV	1kV	10pF	100
1.5kV	1.5kV	1.5kV	1.5kV	12	120
2kV	2kV	2kV	2kV	15	150
2.5kV	2.5kV	2.5kV	2.5kV	18	180
3kV	3kV	3kV	3kV	22	220
3.5kV	3.5kV	3.5kV	3.5kV	27	270
4kV	4kV	4kV	4kV	33	330
4.5kV	4.5kV	4.5kV	4.5kV	39	390
5kV	5kV	5kV	5kV	47	470
6kV	6kV	6kV	6kV	56	560
6.3mm	6.3mm	6.3mm	6.3mm	68	680
6.5mm	6.5mm	6.5mm	6.5mm	82	820
6.8mm	6.8mm	6.8mm	6.8mm	100pF	101
7.0mm	7.0mm	7.0mm	7.0mm	120	121
7.2mm	7.2mm	7.2mm	7.2mm	150	151
7.5mm	7.5mm	7.5mm	7.5mm	180	181
7.8mm	7.8mm	7.8mm	7.8mm	220	221
8.0mm	8.0mm	8.0mm	8.0mm	270	271
8.2mm	8.2mm	8.2mm	8.2mm	330	331
8.5mm	8.5mm	8.5mm	8.5mm	390	391
8.8mm	8.8mm	8.8mm	8.8mm	470	471
9.0mm	9.0mm	9.0mm	9.0mm	560	561
9.2mm	9.2mm	9.2mm	9.2mm	680	681
9.5mm	9.5mm	9.5mm	9.5mm	820	821
9.8mm	9.8mm	9.8mm	9.8mm	1.0nF	102
10.0mm	10.0mm	10.0mm	10.0mm	1.2	122
10.2mm	10.2mm	10.2mm	10.2mm	1.5	152
10.5mm	10.5mm	10.5mm	10.5mm	1.8	182
10.8mm	10.8mm	10.8mm	10.8mm	2.2	222
11.0mm	11.0mm	11.0mm	11.0mm	2.7	272
11.2mm	11.2mm	11.2mm	11.2mm	3.3	332
11.5mm	11.5mm	11.5mm	11.5mm	3.9	392
11.8mm	11.8mm	11.8mm	11.8mm	4.7	472
12.0mm	12.0mm	12.0mm	12.0mm	5.6	562
12.2mm	12.2mm	12.2mm	12.2mm	6.8	682
12.5mm	12.5mm	12.5mm	12.5mm	8.2	822
12.8mm	12.8mm	12.8mm	12.8mm	10nF	103
13.0mm	13.0mm	13.0mm	13.0mm	12	123
13.2mm	13.2mm	13.2mm	13.2mm	15	153
13.5mm	13.5mm	13.5mm	13.5mm	18	183
13.8mm	13.8mm	13.8mm	13.8mm	22	223
14.0mm	14.0mm	14.0mm	14.0mm	27	273
14.2mm	14.2mm	14.2mm	14.2mm	33	333
14.5mm	14.5mm	14.5mm	14.5mm	39	393
14.8mm	14.8mm	14.8mm	14.8mm	47	473
15.0mm	15.0mm	15.0mm	15.0mm	56	563
15.2mm	15.2mm	15.2mm	15.2mm	68	683
15.5mm	15.5mm	15.5mm	15.5mm	82	823
15.8mm	15.8mm	15.8mm	15.8mm	100nF	104
16.0mm	16.0mm	16.0mm	16.0mm	120	124
16.2mm	16.2mm	16.2mm	16.2mm	150	154
16.5mm	16.5mm	16.5mm	16.5mm	180	184
16.8mm	16.8mm	16.8mm	16.8mm	220	224
17.0mm	17.0mm	17.0mm	17.0mm	270	274
17.2mm	17.2mm	17.2mm	17.2mm	330	334
17.5mm	17.5mm	17.5mm	17.5mm	390	394
17.8mm	17.8mm	17.8mm	17.8mm	470	474
18.0mm	18.0mm	18.0mm	18.0mm	560	564
18.2mm	18.2mm	18.2mm	18.2mm	680	684
18.5mm	18.5mm	18.5mm	18.5mm	820	824
18.8mm	18.8mm	18.8mm	18.8mm	1.0μF	105
19.0mm	19.0mm	19.0mm	19.0mm	1.2	125
19.2mm	19.2mm	19.2mm	19.2mm	1.5	155
19.5mm	19.5mm	19.5mm	19.5mm	1.8	185
19.8mm	19.8mm	19.8mm	19.8mm	2.2	225
20.0mm	20.0mm	20.0mm	20.0mm	2.7	275
20.2mm	20.2mm	20.2mm	20.2mm	3.3	335
20.5mm	20.5mm	20.5mm	20.5mm	3.9	395
20.8mm	20.8mm	20.8mm	20.8mm	4.7	475
21.0mm	21.0mm	21.0mm	21.0mm	5.6	565
21.2mm	21.2mm	21.2mm	21.2mm	6.8	685
21.5mm	21.5mm	21.5mm	21.5mm	8.2	825
21.8mm	21.8mm	21.8mm	21.8mm	10μF	106
22.0mm	22.0mm	22.0mm	22.0mm	12	126
22.2mm	22.2mm	22.2mm	22.2mm	15μF	156

Radial Leaded Capacitors - COG/NP0 & X7R ranges

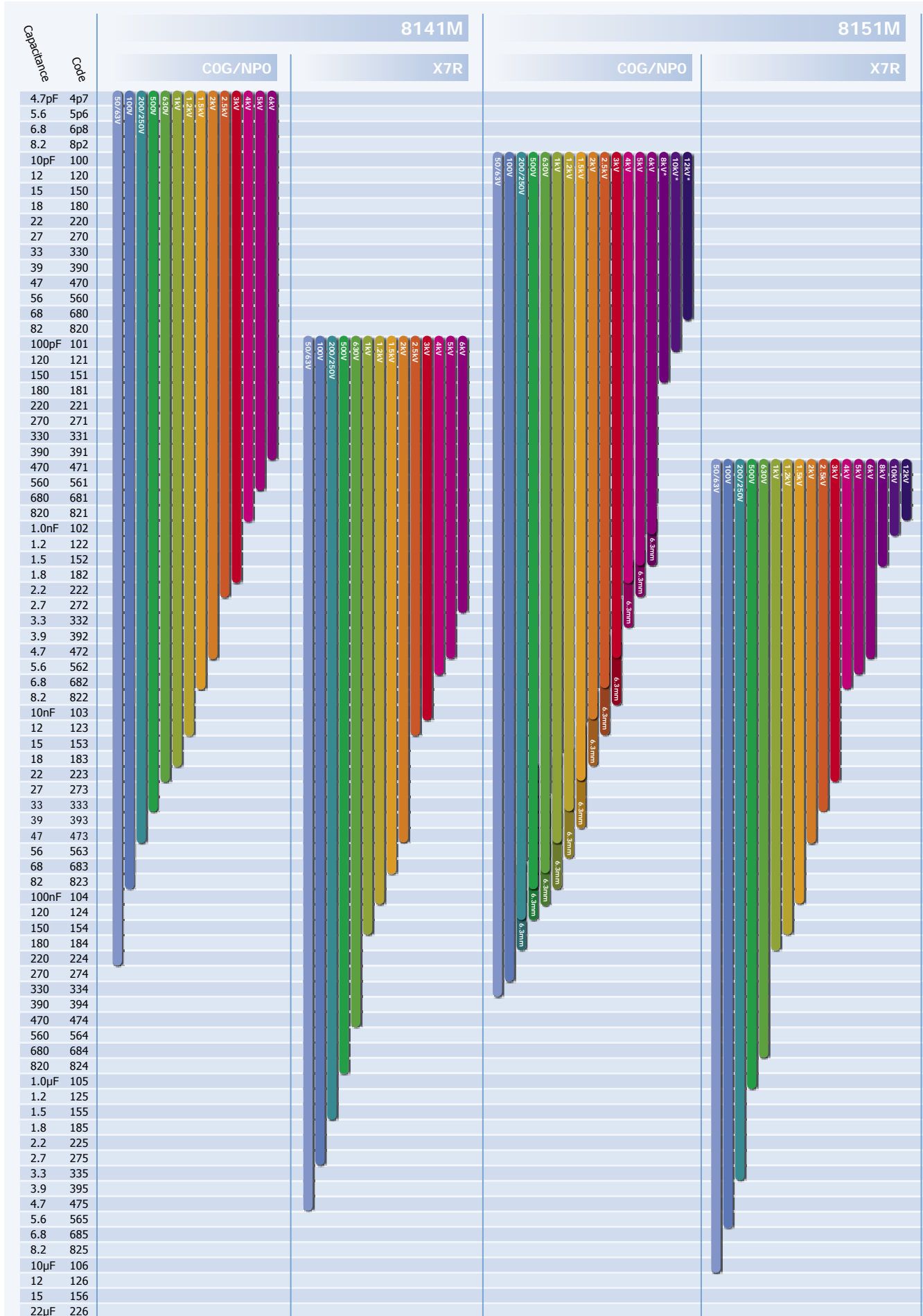

Radial Leaded Capacitors - COG/NP0 & X7R ranges

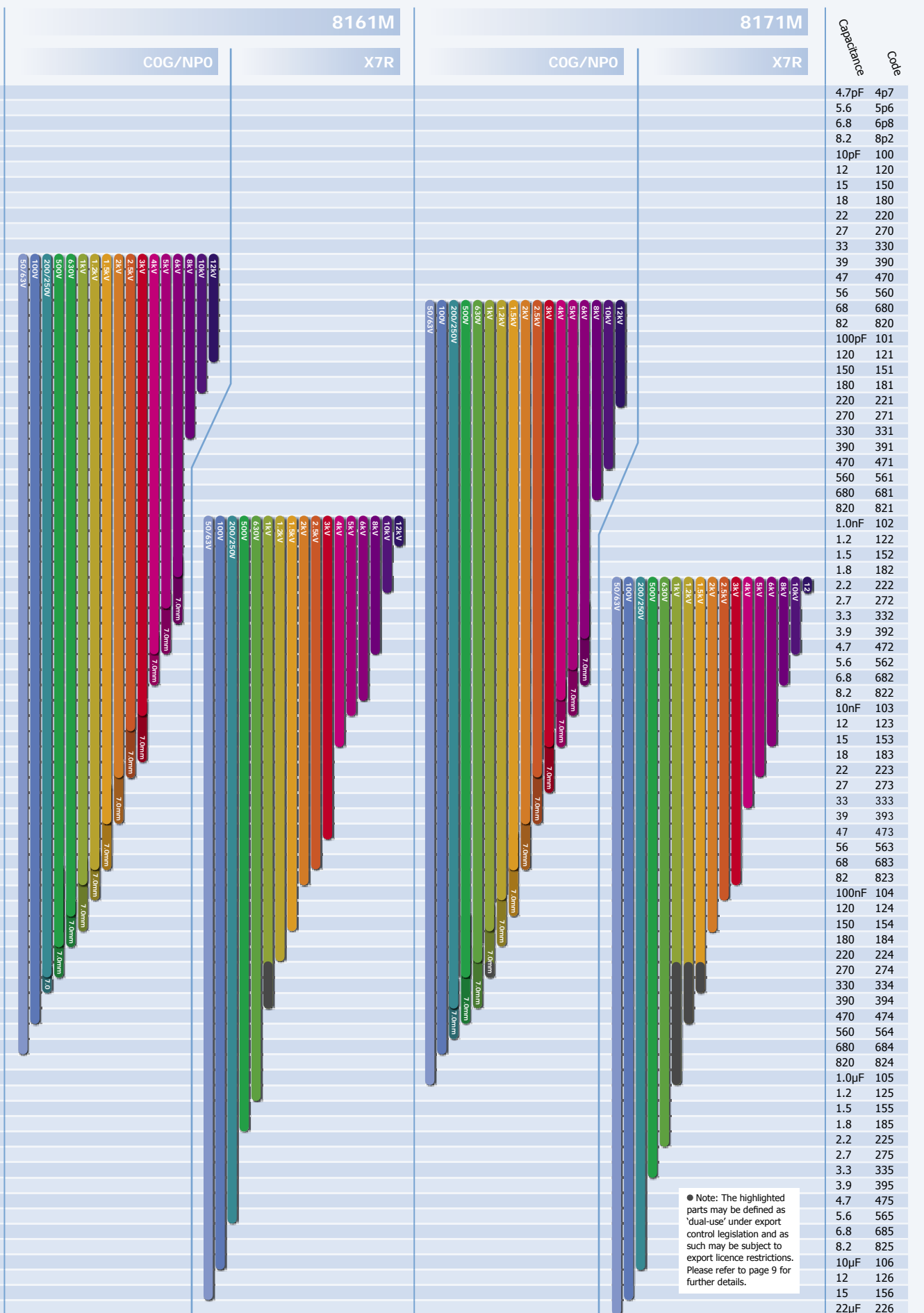

Radial Leded Capacitors - Packaging information

Cropped leads

Cropped leads between 4.0 (0.157) and 30.0 (1.18) are available to special order. Some of the preferred codes are listed below, together with the appropriate suffix code.

Dimensions as for standard product except as specified.

Suffix code - AE3 All radial ranges	Suffix code - AE4 All radial ranges	Suffix code - AD7 All radial ranges	Suffix code - AD5 All radial ranges
Lead length (L) 6 ± 1 (0.236 ± 0.04) from seating plane	Lead length (L) 4 ± 1 (0.162 ± 0.04) from seating plane	Lead length (L) 5 ± 1 (0.2 ± 0.04) from seating plane	Lead length (L) 10 ± 1 (0.4 ± 0.04) from seating plane

Dimensions mm (inches)

Snap in leads

Various forms of snap in leads (preformed) are available to special order, some of the preferred suffix codes are listed below.

Dimensions as for standard product except as specified.

Suffix code - AD1

For PCB holes 0.9mm diameter
Types 8121N and 8131M

Dimensions

Y = 8121N 8 (0.315) Max
8131M 10 (0.394) Max
L = Min: 2.75 (0.108)
Max: 3.50 (0.138)

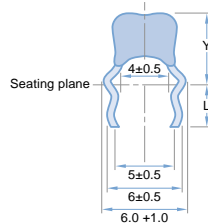

Suffix code - AD2

For PCB holes 1.2mm diameter
Types 8131M

Dimensions

Y = 10 (0.294) Max
L = Min: 2.75 (0.108)
Max: 3.50 (0.138)

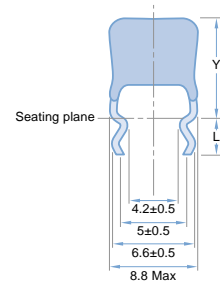

Suffix code - AD3

For PCB holes 1.2mm diameter
Types 8121N

Dimensions

Y = 8 (0.315) Max
L = Min: 2.75 (0.108)
Max: 3.50 (0.138)

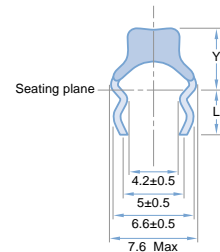

Bandoliered suffix codes

Dipped radial leded with 2.54 and 5.08mm lead spacing can be supplied bandoliered on reels or in ammo boxes to special order. Some of the preferred suffix codes for bandoliered products are given below.

For bandoliered products the minimum order quantity, pieces, is specified in the tables below, larger orders must be in multiples of this quantity.

Dipped – straight and formed leads

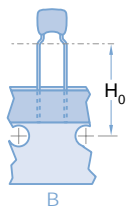
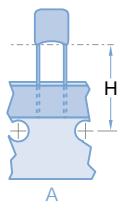

Product code	Lead style	Diagram	H	H ₀	Suffix code		
					Reel 2500pcs	AMMO pack	
					1000pcs	2000pcs	
8111M	Straight 2.54 crs	A	19±1	–	C01	C02	C11
8111M	Straight 2.54 crs	A	16±0.5	–	C30	C31	C32
8111N	Formed 5.08 crs	B	–	16±0.5	C01	C02	C11
8121M	Straight 2.54 crs	A	19±1	–	C01	C02	C11
8121M	Straight 2.54 crs	A	16±0.5	–	C30	C31	C32
8121N	Formed 5.08 crs	B	–	16±0.5	C01	C02	C11
8131M	Straight 5.08 crs	A	19±1	–	C01	C02	C11
8131M	Straight 5.08 crs	A	16±0.5	–	C30	C31	C32

8121T and 8131T available in bulk packaging only.

Dipped – stand-off lead form

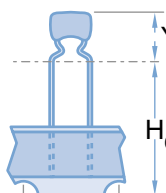

This style has been developed to provide a meniscus-free seating plane with a stress relieving form for auto-insertion.

Product code	Lead style	Y max	H ₀	2500pcs	1000pcs	2000pcs
8111N	Formed 5.08 crs	7.5	16±0.5	C12	C23	C22
8111N	Formed 5.08 crs	7.5	19±1	C13	C25	C24
8121N	Formed 5.08 crs	8.5	16±0.5	C12	C23	C22
8121N	Formed 5.08 crs	8.5	19±1	C13	C25	C24

Radial Leaded Capacitors - Packaging information

A maximum of 3 consecutive components may be missing from the bandolier, followed by at least 6 filled positions.

Components missing from the bandolier are included in the total quantity, whereby the number of missing components may not exceed 0.25% of this total per packing module.

At the beginning and end of a reel the bandolier will exhibit at least 10 blank positions.

Minimum pull strength of product from tape = 5N.

Each reel/carton is provided with a label showing the:
 Manufacturer, product style, batch identification, quantity and date code.

Labelling with bar codes (code 39) is available on request.

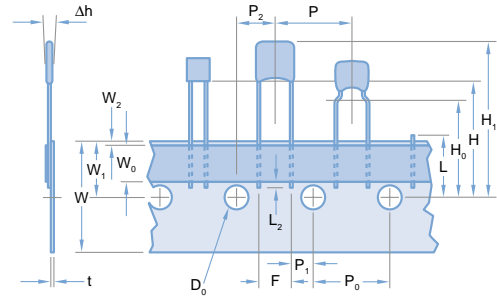

In accordance with IEC 60286 part 2.

Dimensions mm (inches)

Description	Symbol	2.5mm lead space	5mm lead space	Tolerance
Lead wire diameter	d	0.5 (0.02) 0.6 (0.025)	0.5 (0.02) 0.6 (0.025)	±0.05 (0.002)
Component pitch	P	12.7 (0.5)	12.7 (0.5)	1.00 (0.04)
Feed hole pitch	P ₀	12.7 (0.5)	12.7 (0.5)	±0.30 (0.01)
Feed hole centre to lead	P ₁	5.08 (0.2)	3.81 (0.15)	±0.70 (0.03)
Feed hole centre to component	P ₂	6.35 (0.25)	6.35 (0.25)	±0.70 (0.03)
Lead spacing	F	2.54 (0.10)	5.08 (0.20)	+0.6 (0.02) -0.1 (0.004)
Component alignment	Δh	0	0	±2.00(0.08)
Tape width	W	18.0 (0.70)	18.0 (0.70)	+1.00 (0.04) -0.50 (0.02)
Hold down tape width	W ₀	6.0 (0.23)	6.0 (0.23)	±0.30 (0.01)
Hole position	W ₁	9.0 (0.35)	9.0 (0.35)	±0.50 (0.02)
Hold down tape position	W ₂	0.50 (0.02)	0.50 (0.02)	Max
Height to seating plane from tape centre (straight leads) (2)	H	16 (0.63) to 20 (0.79)	16 (0.63) to 20 (0.79)	As required
Height to seating plane from tape centre (formed leads) (2)	H ₀	16 (0.63) to 20 (0.79)	16 (0.63) to 20 (0.79)	As required
Height to top of component from tape centre	H ₁	32.2 (1.26)	32.2 (1.26)	Max
Feed hole diameter	D ₀	4.0 (0.16)	4.0 (0.16)	±0.20 (0.008)
Carrier tape plus adhesive tape thickness	t	0.7 (0.03)	0.7 (0.03)	±0.20 (0.008)
Carrier tape thickness	-	0.5 (0.02)	0.5 (0.02)	±0.10 (0.004)
Cut out component snipped lead length from tape centre	L	11.0 (0.43)	11.0 (0.43)	Max
Lead wire protrusion from hold down	L ₂	2.0 (0.08)	2.0 (0.08)	Max

Bandoliered reels

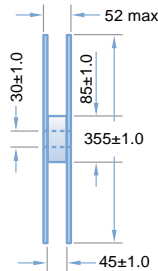
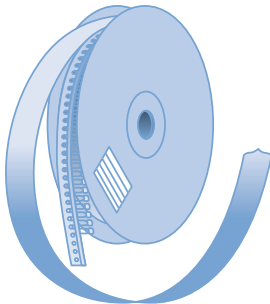

The adhesive tape faces outwards. The dispensing direction is as shown. For the protection of the components a paper inlay is inserted between the windings of the bandolier. At the end of the bandolier this paper inlay continues for at least a further two rotations.

Bandoliered ammo packing

2 carton sizes

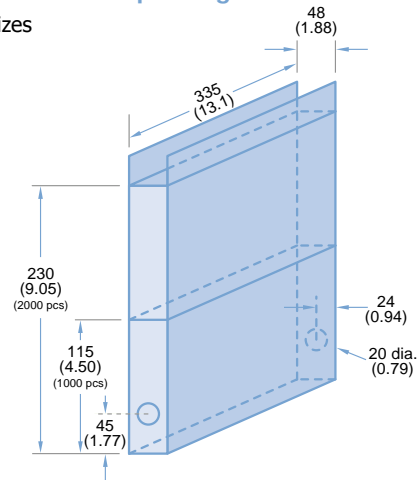



knowles

DLI•Novacap•Syfer•Voltronics



Knowles Capacitors designs, manufactures and sells special electronic components. Our products are used in military, space, telecom infrastructure, medical and industrial applications where function and reliability are crucial.



Knowles (Cazenovia)
2777 Route 20 East, Cazenovia, NY 13035 USA



Phone: +1 315 655 8710
Fax: +1 315 655 0445
DLISales@knowles.com



Novacap
25111 Anza Drive, Valencia, CA 91355 USA



Phone: +1 661 295 5920
Fax: +1 661 295 5928
NovacapSales@knowles.com



Knowles (UK) Ltd
Old Stoke Road, Arminghall, Norwich, NR14 8SQ UK



Phone: +44 1603 723300
Fax: +44 1603 723301
SyferSales@knowles.com



Voltronics Corporation
2250 Northwood Drive, Salisbury, MD 21801 USA



Phone: +1 410 749 2424
Fax: +1 443 260 2263
VoltronicsSales@knowles.com

9706/MLC/15/