

## Peak Emission Wavelength: 1650nm

The MTE5116N2 consists of a 1650nm high output infrared die in a water-clear 5mm plastic molded package. Custom package solutions and sorting are available.

### FEATURES

- > High Output Power
- > Narrow Beam Angle
- > High Reliability

### APPLICATIONS

- > Optical Switches & Sensors
- > Fiber Optical Communication
- > Bar-code Reader

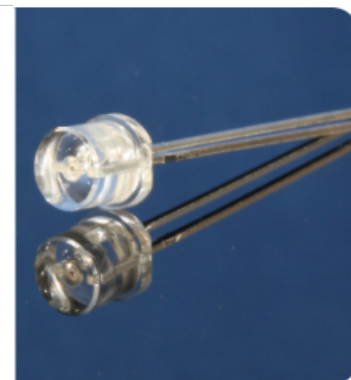

## Absolute Maximum Ratings (Ta=25°C)



ITEMS	SYMBOL	RATINGS	UNIT
Forward Current (DC)	IF	100	mA
Forward Current (Pulse)*1	IFP	1	A
Reverse Voltage	VR	5	V
Power Dissipation	PD	110	mW
Operating Temperature Range	Topr	-20 ~ +80	°C
Storage Temperature Range	Tstg	-30 ~ +100	°C
Junction Temperature	Tj	100	°C
Lead Soldering Temperature*2	Tls	260	°C

\*1: Tw=10μsec, T=10msec. \*2: Time 5Sec max, Position: Up to 3mm from the body.

## Electrical & Optical Characteristics (Ta = 25°C)

ITEMS	SYMBOL	CONDITIONS	MIN	TYP	MAX	UNIT
Power Output	PO	IF=20mA	--	1.9	--	mW
Power Output	PO	IF=50mA	--	3.5	--	mW
Forward Voltage	VF	IF=20mA	--	0.85	--	V
Forward Voltage	VF	IF=50mA	--	0.95	--	V
Reverse Current	IR	VR=5V	--	--	100	μA
Peak Emission Wavelength	λp	IF=50mA	--	1650	--	nm
Spectral Line Half Width	Δλ	IF=50mA	--	115	--	nm
Half Intensity Beam Angle	Θ	IF=50mA	--	±45	--	deg

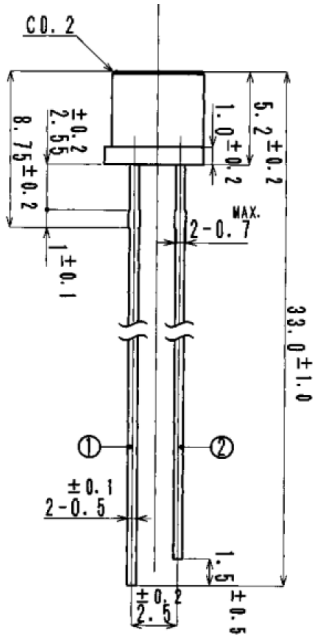

- ① Anode
- ② Cathode

**SPECTRAL OUTPUT**

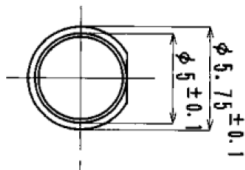
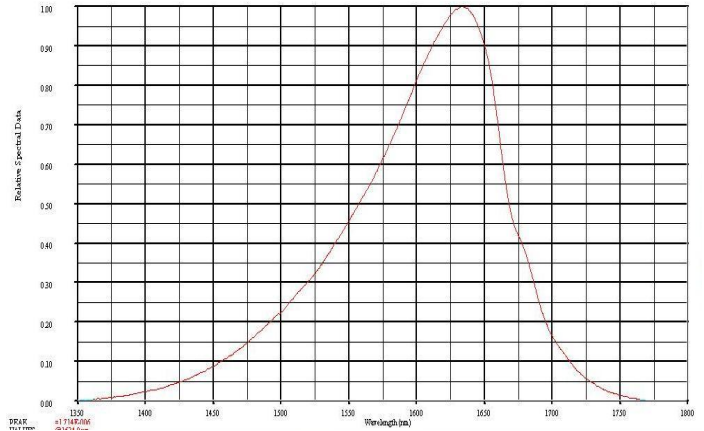

**Forward I-V Characteristics**

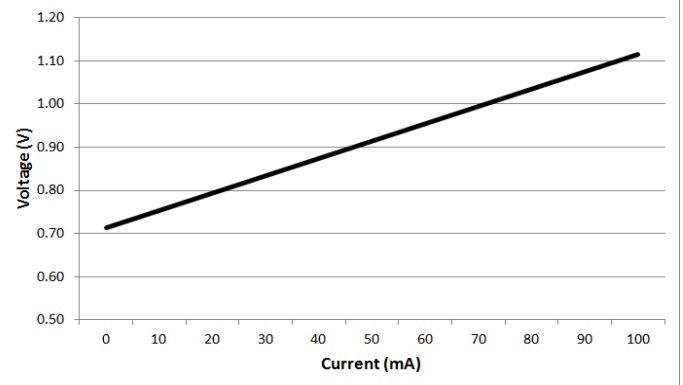

Unit: mm, Tolerance:  $\pm 0.2$

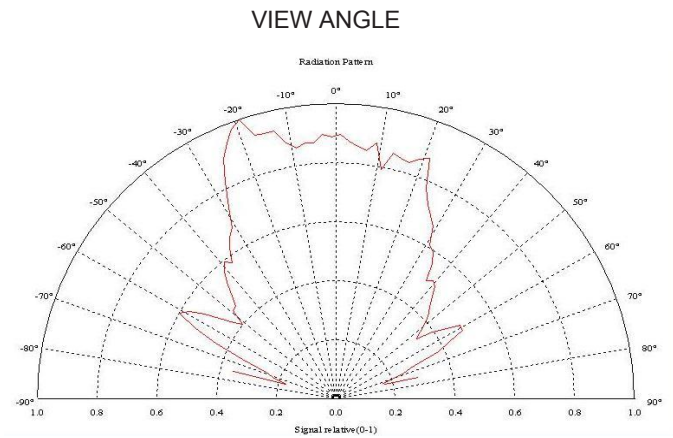
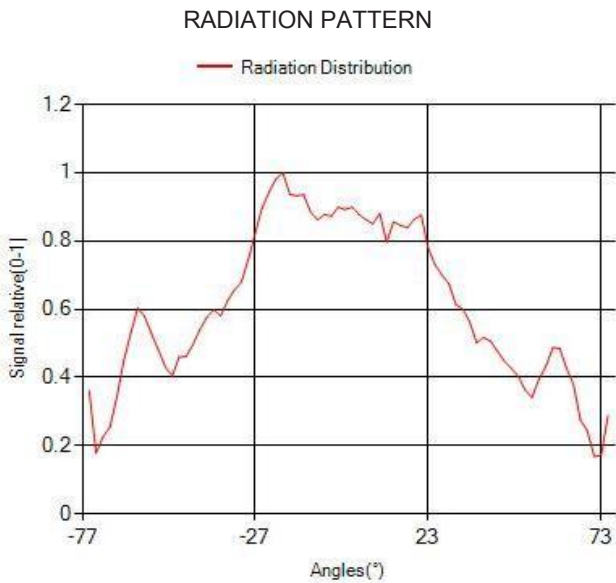

The information contained herein is subject to change without notice.

2019-06-18

# Mouser Electronics

Authorized Distributor

Click to View Pricing, Inventory, Delivery & Lifecycle Information:

[Marktech Optoelectronics:](#)

[MTE5116N2](#)