

## Cree® XLamp® XB Family LEDs

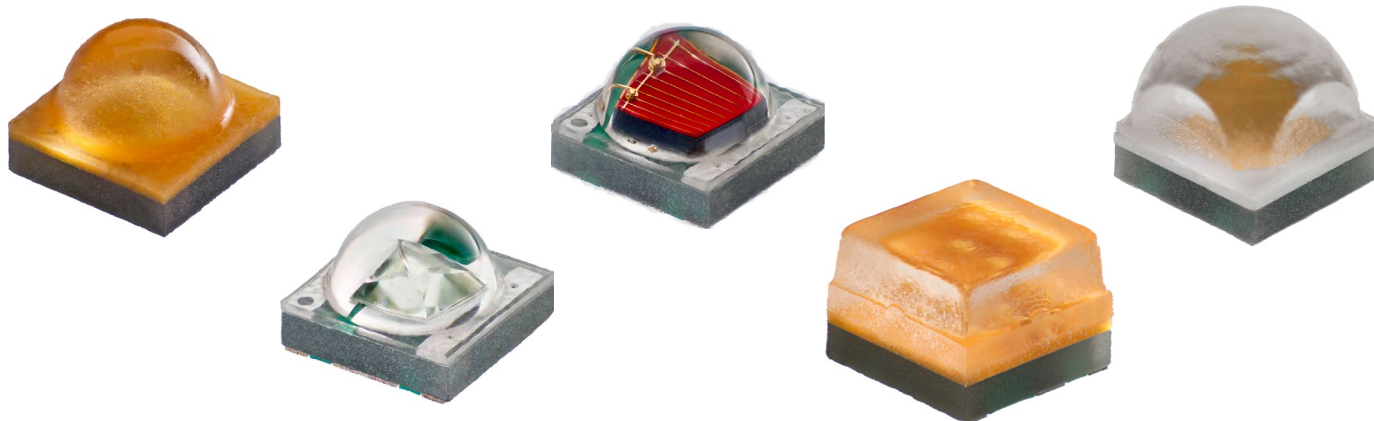

### TABLE OF CONTENTS

Bin and Order Code Formats .....	2
Performance Groups – Luminous or Radiant Flux .....	4
Performance Groups – Dominant Wavelength .....	5
Performance Groups – Forward Voltage .....	6
Performance Groups – Chromaticity.....	7
Cree’s Standard Chromaticity Regions Plotted on the 1931 CIE Curve .....	10
Cree’s Standard Cool White Kits Plotted on ANSI Standard Chromaticity Regions .....	12
Cree’s Outdoor White Kits Plotted on ANSI Standard Chromaticity Regions .....	13
Cree’s Standard Warm and Neutral White Kits Plotted on ANSI Standard Chromaticity Regions.....	15
Cree’s Standard Chromaticity Kits .....	16
Standard Order Codes and Bins	
XB-D ANSI Cool White.....	18
XB-D Neutral White.....	19
XB-D Warm White .....	20
XB-D Color.....	22
XB-E HVW Neutral White.....	26
XB-E HVW Warm White .....	26
XB-G HVW Warm White.....	27
XB-H ANSI Cool White.....	28
XB-H Neutral White.....	29
XB-H Warm White .....	31

### INTRODUCTION

This document describes the product nomenclature required to select and order Cree’s XLamp® XB family LEDs. XLamp XB family LEDs are tested and sorted into bins which are then combined into orderable kits, identified by an order code.

All XLamp LEDs are tested and sorted by color and brightness into a unique bin. Each bin contains LEDs from only one color and brightness group and is uniquely identified by a bin code. White XLamp LEDs are sorted by chromaticity (color) and luminous flux (brightness). Color XLamp LEDs are sorted by dominant wavelength (color) and luminous or radiant flux (brightness). LEDs are shipped in reels containing LEDs from a single bin and labeled with the corresponding bin code. XLamp LED packaging details are provided in product data sheets.

Kits contain LEDs from a number of similar bins and are fully defined by their order codes. A full explanation of the order codes for XLamp XB family LEDs, as well as a list of standard order codes, is provided in this document.

**BIN AND ORDER CODE FORMATS**

Bin codes and order codes for XB family LEDs, except for XB-H LEDs, are configured in the following manner:

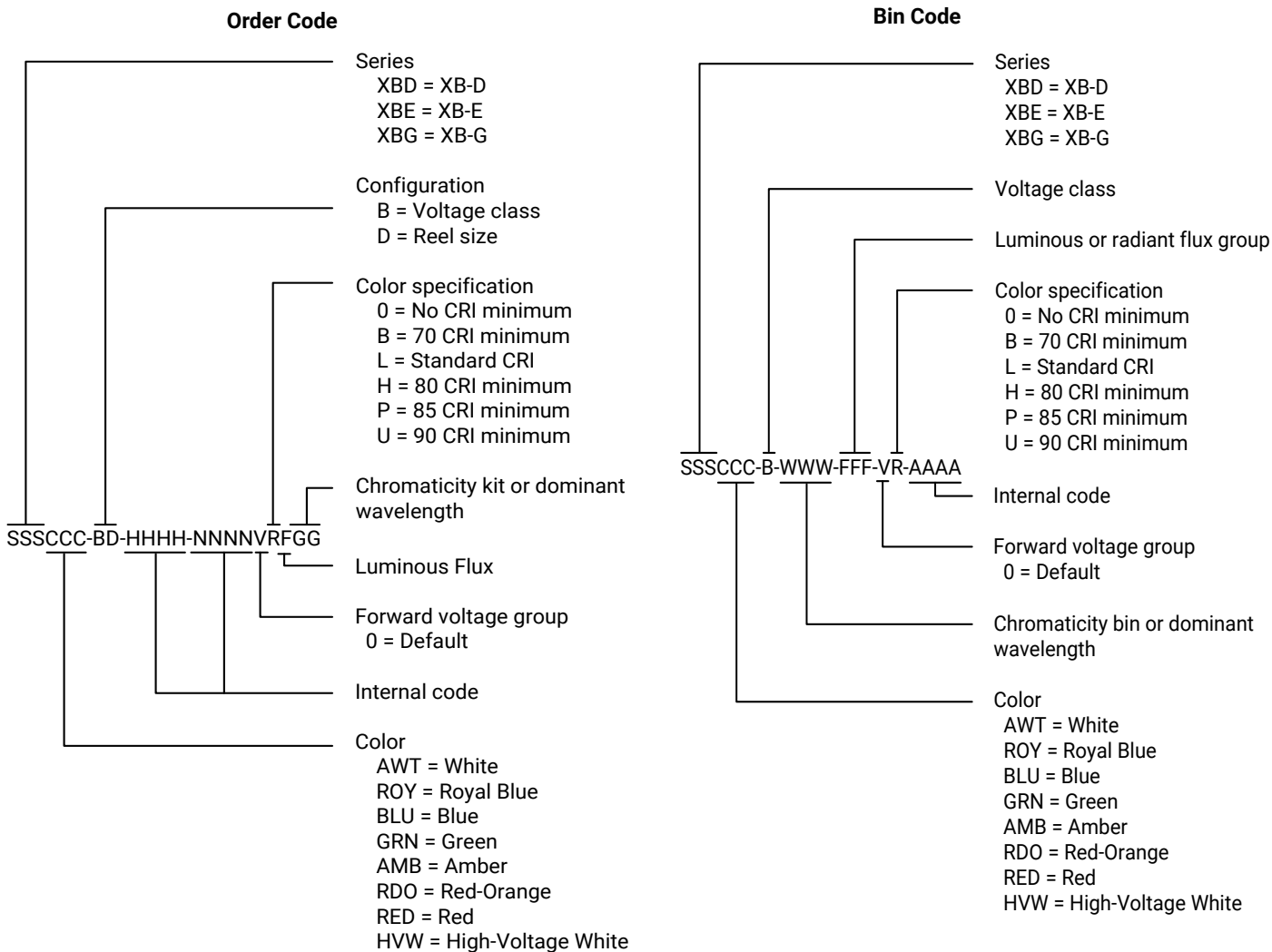

Example Order Code: XBDAWT-00-0000-0000HAE7

Example Bin Code: XBDAWT-0-7A3-Q20-0H-0001

**BIN AND ORDER CODE FORMATS - CONTINUED**

Bin codes and order codes for XB-H LEDs are configured in the following manner:

**Order Code**

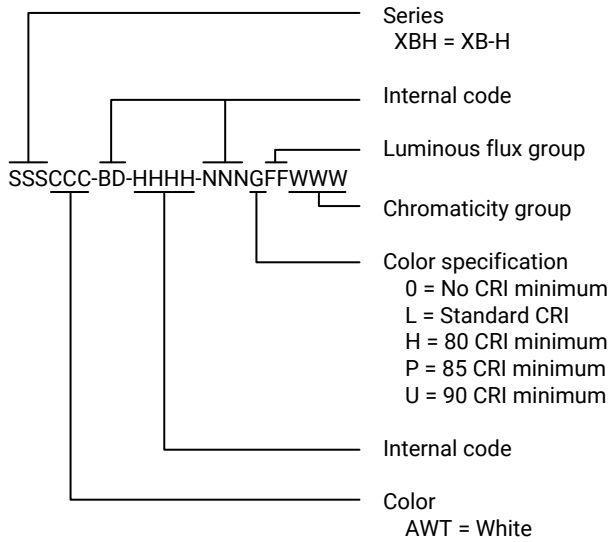

Example Order Code: XBHAWT-00-0000-000HT20E7

**Bin Code**

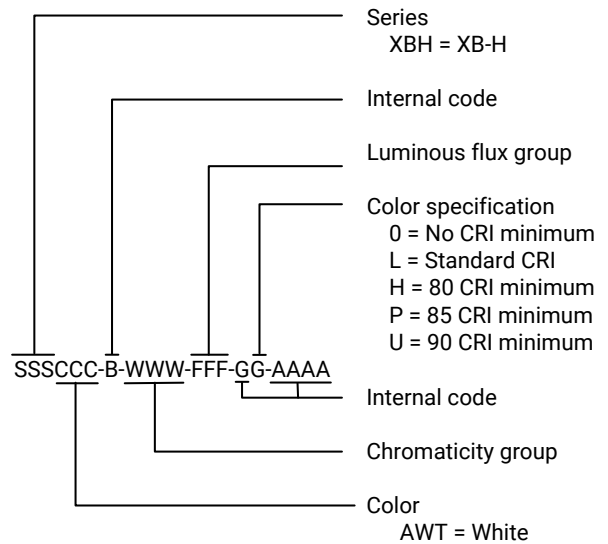

Example Bin Code: XBHAWT-0-7A3-T20-0H-0001

## PERFORMANCE GROUPS – LUMINOUS OR RADIANT FLUX

XLamp XB family LEDs, except Royal Blue and XB-H LEDs, are tested for luminous flux and placed into one of the following luminous-flux groups. These groups, appended with a 0, are used in the Bin Code “Luminous or radiant flux group.”

Group Code	Minimum Luminous Flux @ 350 mA (lm)	Maximum Luminous Flux @ 350 mA (lm)
K2	30.6	35.2
K3	35.2	39.8
M2	39.8	45.7
M3	45.7	51.7
N2	51.7	56.8
N3	56.8	62
N4	62	67.2
P2	67.2	73.9
P3	73.9	80.6
P4	80.6	87.4
Q2	87.4	93.9
Q3	93.9	100
Q4	100	107
Q5	107	114
R2	114	122
R3	122	130
R4	130	139
R5	139	148
S2	148	156

XLamp XB-H LEDs are tested for luminous flux and placed into one of the following luminous-flux groups. These groups, appended with a 0, are used in the Bin Code “Luminous or radiant flux group.”

Group Code	Minimum Luminous Flux @ 700 mA (lm)	Maximum Luminous Flux @ 700 mA (lm)
S4	164	172
S5	172	182
S6	182	200
T2	200	220
T3	220	240
T4	240	260
T5	260	280
T6	280	300
U2	300	320

## PERFORMANCE GROUPS – LUMINOUS OR RADIANT FLUX (CONTINUED)

Royal-blue XLamp LEDs are tested for radiant flux and sorted into one of the following radiant-flux bins.

Group	Minimum Radiant Flux (mW) @ 350 mA	Maximum Radiant Flux (mW) @ 350 mA
30	450	475
31	475	500
32	500	525
33	525	550
34	550	575
35	575	600
36	600	625
37	625	650
38	650	675
39	675	700
40	700	725

## PERFORMANCE GROUPS – DOMINANT WAVELENGTH

Color XLamp LEDs are tested for dominant wavelength (DWL) and sorted into one of the DWL bins defined below.

Color	DWL Group	Minimum DWL (nm) @ 350 mA	Maximum DWL (nm) @ 350 mA
Royal Blue	D36	450	452.5
	D37	452.5	455
	D46	455	457.5
	D47	457.5	460
	D56	460	462.5
	D57	462.5	465
Blue	B3	465	470
	B4	470	475
	B5	475	480
	B6	480	485
Green	G2	520	525
	G3	525	530
	G4	530	535
Amber	A2	585	590
	A3	590	595
Red-Orange	O3	610	615
	O4	615	620
Red	R2	620	625
	R3	625	630

**PERFORMANCE GROUPS – FORWARD VOLTAGE**

Amber, red-orange, red and royal blue XLamp XB family LEDs are tested for forward voltage and sorted into one of the forward voltage bins defined below.

Forward Voltage Group	Minimum Forward Voltage @ 350 mA	Maximum Forward Voltage @ 350 mA
B	1.75	2.0
C	2.0	2.25
D	2.25	2.5
E	2.5	2.75
F	2.75	3.0
G	3.0	3.25
H	3.25	3.5

**PERFORMANCE GROUPS – CHROMATICITY**

Region	x	y	Region	x	y	Region	x	y	Region	x	y
0A	0.2950	0.2970	0B	0.2920	0.3060	0C	0.2984	0.3133	0D	0.2984	0.3133
	0.2920	0.3060		0.2895	0.3135		0.2962	0.3220		0.3048	0.3207
	0.2984	0.3133		0.2962	0.3220		0.3028	0.3304		0.3068	0.3113
	0.3009	0.3042		0.2984	0.3133		0.3048	0.3207		0.3009	0.3042
0R	0.2980	0.2880	0S	0.2895	0.3135	0T	0.2962	0.3220	0U	0.3037	0.2937
	0.2950	0.2970		0.2870	0.3210		0.2937	0.3312		0.3009	0.3042
	0.3009	0.3042		0.2937	0.3312		0.3005	0.3415		0.3068	0.3113
	0.3037	0.2937		0.2962	0.3220		0.3028	0.3304		0.3093	0.2993
1A	0.3048	0.3207	1B	0.3028	0.3304	1C	0.3115	0.3391	1D	0.3130	0.3290
	0.3130	0.3290		0.3115	0.3391		0.3205	0.3481		0.3213	0.3373
	0.3144	0.3186		0.3130	0.3290		0.3213	0.3373		0.3221	0.3261
	0.3068	0.3113		0.3048	0.3207		0.3130	0.3290		0.3144	0.3186
1R	0.3068	0.3113	1S	0.3005	0.3415	1T	0.3099	0.3509	1U	0.3144	0.3186
	0.3144	0.3186		0.3099	0.3509		0.3196	0.3602		0.3221	0.3261
	0.3161	0.3059		0.3115	0.3391		0.3205	0.3481		0.3231	0.3120
	0.3093	0.2993		0.3028	0.3304		0.3115	0.3391		0.3161	0.3059
2A	0.3215	0.3350	2B	0.3207	0.3462	2C	0.3290	0.3538	2D	0.3290	0.3417
	0.3290	0.3417		0.3290	0.3538		0.3376	0.3616		0.3371	0.3490
	0.3290	0.3300		0.3290	0.3417		0.3371	0.3490		0.3366	0.3369
	0.3222	0.3243		0.3215	0.3350		0.3290	0.3417		0.3290	0.3300
2R	0.3222	0.3243	2S	0.3196	0.3602	2T	0.3290	0.3690	2U	0.3290	0.3300
	0.3290	0.3300		0.3290	0.3690		0.3381	0.3762		0.3366	0.3369
	0.3290	0.3180		0.3290	0.3538		0.3376	0.3616		0.3361	0.3245
	0.3231	0.3120		0.3207	0.3462		0.3290	0.3538		0.3290	0.3180
3A	0.3371	0.3490	3B	0.3376	0.3616	3C	0.3463	0.3687	3D	0.3451	0.3554
	0.3451	0.3554		0.3463	0.3687		0.3551	0.3760		0.3533	0.3620
	0.3440	0.3427		0.3451	0.3554		0.3533	0.3620		0.3515	0.3487
	0.3366	0.3369		0.3371	0.3490		0.3451	0.3554		0.3440	0.3427
3R	0.3366	0.3369	3S	0.3381	0.3762	3T	0.3480	0.3840	3U	0.3440	0.3428
	0.3440	0.3428		0.3480	0.3840		0.3571	0.3907		0.3515	0.3487
	0.3429	0.3307		0.3463	0.3687		0.3551	0.3760		0.3495	0.3339
	0.3361	0.3245		0.3376	0.3616		0.3463	0.3687		0.3429	0.3307
4A	0.3530	0.3597	4B	0.3548	0.3736	4C	0.3641	0.3804	4D	0.3615	0.3659
	0.3615	0.3659		0.3641	0.3804		0.3736	0.3874		0.3702	0.3722
	0.3590	0.3521		0.3615	0.3659		0.3702	0.3722		0.3670	0.3578
	0.3512	0.3465		0.3530	0.3597		0.3615	0.3659		0.3590	0.3521
4R	0.3512	0.3465	4S	0.3571	0.3907	4T	0.3668	0.3957	4U	0.3590	0.3521
	0.3590	0.3521		0.3668	0.3957		0.3771	0.4034		0.3670	0.3578
	0.3567	0.3389		0.3641	0.3804		0.3736	0.3874		0.3640	0.3440
	0.3495	0.3339		0.3548	0.3736		0.3641	0.3804		0.3567	0.3389

## PERFORMANCE GROUPS – CHROMATICITY (CONTINUED)

Region	x	y	Region	x	y	Region	x	y	Region	x	y
5A1	0.3670	0.3578	5A2	0.3686	0.3649	5A3	0.3744	0.3685	5A4	0.3726	0.3612
	0.3686	0.3649		0.3702	0.3722		0.3763	0.3760		0.3744	0.3685
	0.3744	0.3685		0.3763	0.3760		0.3825	0.3798		0.3804	0.3721
	0.3726	0.3612		0.3744	0.3685		0.3804	0.3721		0.3783	0.3646
5B1	0.3702	0.3722	5B2	0.3719	0.3797	5B3	0.3782	0.3837	5B4	0.3763	0.3760
	0.3719	0.3797		0.3736	0.3874		0.3802	0.3916		0.3782	0.3837
	0.3782	0.3837		0.3802	0.3916		0.3869	0.3958		0.3847	0.3877
	0.3763	0.3760		0.3782	0.3837		0.3847	0.3877		0.3825	0.3798
5C1	0.3825	0.3798	5C2	0.3847	0.3877	5C3	0.3912	0.3917	5C4	0.3887	0.3836
	0.3847	0.3877		0.3869	0.3958		0.3937	0.4001		0.3912	0.3917
	0.3912	0.3917		0.3937	0.4001		0.4006	0.4044		0.3978	0.3958
	0.3887	0.3836		0.3912	0.3917		0.3978	0.3958		0.3950	0.3875
5D1	0.3783	0.3646	5D2	0.3804	0.3721	5D3	0.3863	0.3758	5D4	0.3840	0.3681
	0.3804	0.3721		0.3825	0.3798		0.3887	0.3836		0.3863	0.3758
	0.3863	0.3758		0.3887	0.3836		0.3950	0.3875		0.3924	0.3794
	0.3840	0.3681		0.3863	0.3758		0.3924	0.3794		0.3898	0.3716
5R	0.3670	0.3578	5S	0.3771	0.4034	5T	0.3916	0.4127	5U	0.3783	0.3646
	0.3783	0.3646		0.3916	0.4127		0.4064	0.4221		0.3898	0.3716
	0.3743	0.3502		0.3869	0.3958		0.4006	0.4044		0.3848	0.3565
	0.3640	0.3440		0.3736	0.3874		0.3869	0.3958		0.3743	0.3502
6A1	0.3889	0.3690	6A2	0.3915	0.3768	6A3	0.3981	0.3800	6A4	0.3953	0.3720
	0.3915	0.3768		0.3941	0.3848		0.4010	0.3882		0.3981	0.3800
	0.3981	0.3800		0.4010	0.3882		0.4080	0.3916		0.4048	0.3832
	0.3953	0.3720		0.3981	0.3800		0.4048	0.3832		0.4017	0.3751
6B1	0.3941	0.3848	6B2	0.3968	0.3930	6B3	0.4040	0.3966	6B4	0.4010	0.3882
	0.3968	0.3930		0.3996	0.4015		0.4071	0.4052		0.4040	0.3966
	0.4040	0.3966		0.4071	0.4052		0.4146	0.4089		0.4113	0.4001
	0.4010	0.3882		0.4040	0.3966		0.4113	0.4001		0.4080	0.3916
6C1	0.4080	0.3916	6C2	0.4113	0.4001	6C3	0.4186	0.4037	6C4	0.4150	0.3950
	0.4113	0.4001		0.4146	0.4089		0.4222	0.4127		0.4186	0.4037
	0.4186	0.4037		0.4222	0.4127		0.4299	0.4165		0.4259	0.4073
	0.4150	0.3950		0.4186	0.4037		0.4259	0.4073		0.4221	0.3984
6D1	0.4017	0.3751	6D2	0.4048	0.3832	6D3	0.4116	0.3865	6D4	0.4082	0.3782
	0.4048	0.3832		0.4080	0.3916		0.4150	0.3950		0.4116	0.3865
	0.4116	0.3865		0.4150	0.3950		0.4221	0.3984		0.4183	0.3898
	0.4082	0.3782		0.4116	0.3865		0.4183	0.3898		0.4147	0.3814
6R	0.3889	0.3690	6S	0.4054	0.4191	6T	0.4217	0.4273	6U	0.4017	0.3751
	0.4017	0.3751		0.4217	0.4273		0.4382	0.4356		0.4147	0.3814
	0.3957	0.3596		0.4146	0.4089		0.4299	0.4165		0.4077	0.3652
	0.3840	0.3540		0.3996	0.4015		0.4146	0.4089		0.3957	0.3596



## PERFORMANCE GROUPS – CHROMATICITY (CONTINUED)

Region	x	y	Region	x	y	Region	x	y	Region	x	y
7A	0.4221	0.3985	7B	0.4299	0.4165	7C	0.4430	0.4212	7D	0.4342	0.4028
	0.4342	0.4028		0.4430	0.4212		0.4562	0.426		0.4465	0.4071
	0.4260	0.3853		0.4342	0.4028		0.4465	0.4071		0.4373	0.3893
	0.4147	0.3814		0.4221	0.3985		0.4342	0.4028		0.4260	0.3853
7A1	0.4147	0.3814	7A2	0.4183	0.3898	7A3	0.4242	0.3919	7A4	0.4203	0.3833
	0.4183	0.3898		0.4221	0.3984		0.4281	0.4006		0.4242	0.3919
	0.4242	0.3919		0.4281	0.4006		0.4342	0.4028		0.4300	0.3939
	0.4203	0.3833		0.4242	0.3919		0.4300	0.3939		0.4259	0.3853
7B1	0.4221	0.3984	7B2	0.4259	0.4073	7B3	0.4322	0.4096	7B4	0.4281	0.4006
	0.4259	0.4073		0.4299	0.4165		0.4364	0.4188		0.4322	0.4096
	0.4322	0.4096		0.4364	0.4188		0.4430	0.4212		0.4385	0.4119
	0.4281	0.4006		0.4322	0.4096		0.4385	0.4119		0.4342	0.4028
7C1	0.4342	0.4028	7C2	0.4385	0.4119	7C3	0.4449	0.4141	7C4	0.4403	0.4049
	0.4385	0.4119		0.4430	0.4212		0.4496	0.4236		0.4449	0.4141
	0.4449	0.4141		0.4496	0.4236		0.4562	0.4260		0.4513	0.4164
	0.4403	0.4049		0.4449	0.4141		0.4513	0.4164		0.4465	0.4071
7D1	0.4259	0.3853	7D2	0.4300	0.3939	7D3	0.4359	0.3960	7D4	0.4316	0.3873
	0.4300	0.3939		0.4342	0.4028		0.4403	0.4049		0.4359	0.3960
	0.4359	0.3960		0.4403	0.4049		0.4465	0.4071		0.4418	0.3981
	0.4316	0.3873		0.4359	0.3960		0.4418	0.3981		0.4373	0.3893
8A	0.4465	0.4071	8B	0.4562	0.4260	8C	0.4687	0.4289	8D	0.4582	0.4099
	0.4582	0.4099		0.4687	0.4289		0.4813	0.4319		0.4700	0.4126
	0.4483	0.3918		0.4582	0.4099		0.4700	0.4126		0.4593	0.3944
	0.4373	0.3893		0.4465	0.4071		0.4582	0.4099		0.4483	0.3918
8A1	0.4373	0.3893	8A2	0.4418	0.3981	8A3	0.4475	0.3994	8A4	0.4428	0.3906
	0.4418	0.3981		0.4465	0.4071		0.4523	0.4085		0.4475	0.3994
	0.4475	0.3994		0.4523	0.4085		0.4582	0.4099		0.4532	0.4008
	0.4428	0.3906		0.4475	0.3994		0.4532	0.4008		0.4483	0.3919
8B1	0.4465	0.4071	8B2	0.4513	0.4164	8B3	0.4573	0.4178	8B4	0.4523	0.4085
	0.4513	0.4164		0.4562	0.4260		0.4624	0.4274		0.4573	0.4178
	0.4573	0.4178		0.4624	0.4274		0.4687	0.4289		0.4634	0.4193
	0.4523	0.4085		0.4573	0.4178		0.4634	0.4193		0.4582	0.4099
8C1	0.4582	0.4099	8C2	0.4634	0.4193	8C3	0.4695	0.4207	8C4	0.4641	0.4112
	0.4634	0.4193		0.4687	0.4289		0.4750	0.4304		0.4695	0.4207
	0.4695	0.4207		0.4750	0.4304		0.4813	0.4319		0.4756	0.4221
	0.4641	0.4112		0.4695	0.4207		0.4756	0.4221		0.4700	0.4126
8D1	0.4483	0.3919	8D2	0.4532	0.4008	8D3	0.4589	0.4021	8D4	0.4538	0.3931
	0.4532	0.4008		0.4582	0.4099		0.4641	0.4112		0.4589	0.4021
	0.4589	0.4021		0.4641	0.4112		0.4700	0.4126		0.4646	0.4034
	0.4538	0.3931		0.4589	0.4021		0.4646	0.4034		0.4593	0.3944

**CREE'S STANDARD CHROMATICITY REGIONS PLOTTED ON THE 1931 CIE CURVE**

**ANSI Cool White - XB-D & XB-H**

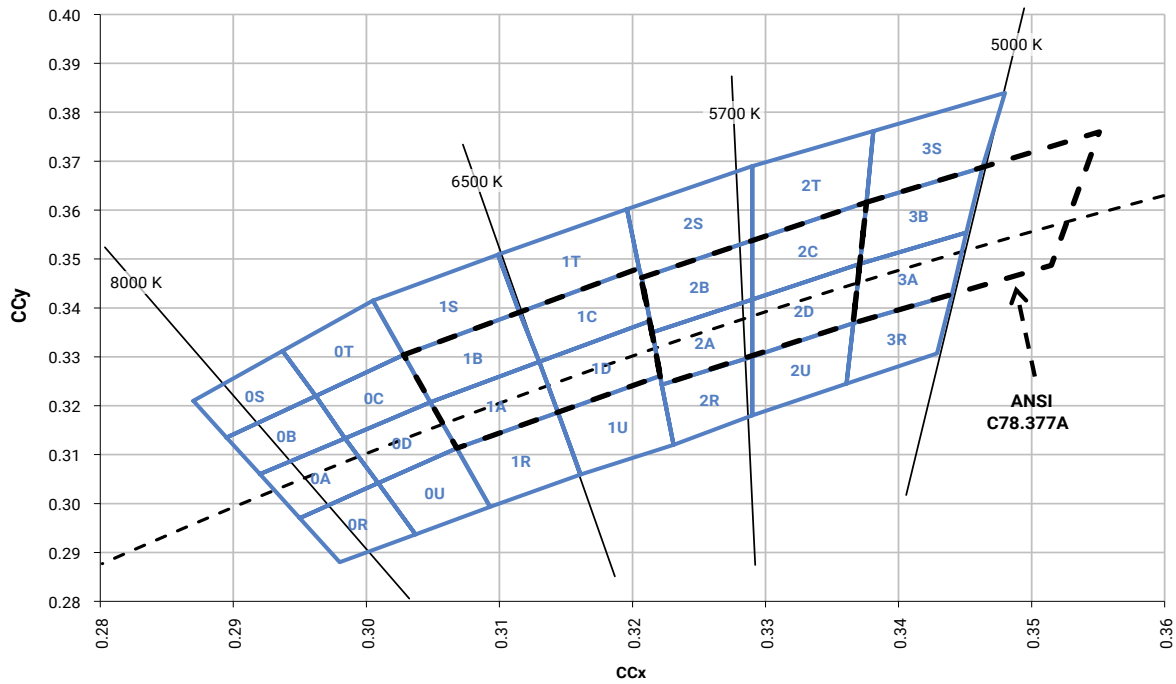

**ANSI Neutral White and ANSI Warm White - XB-D & XB-H**

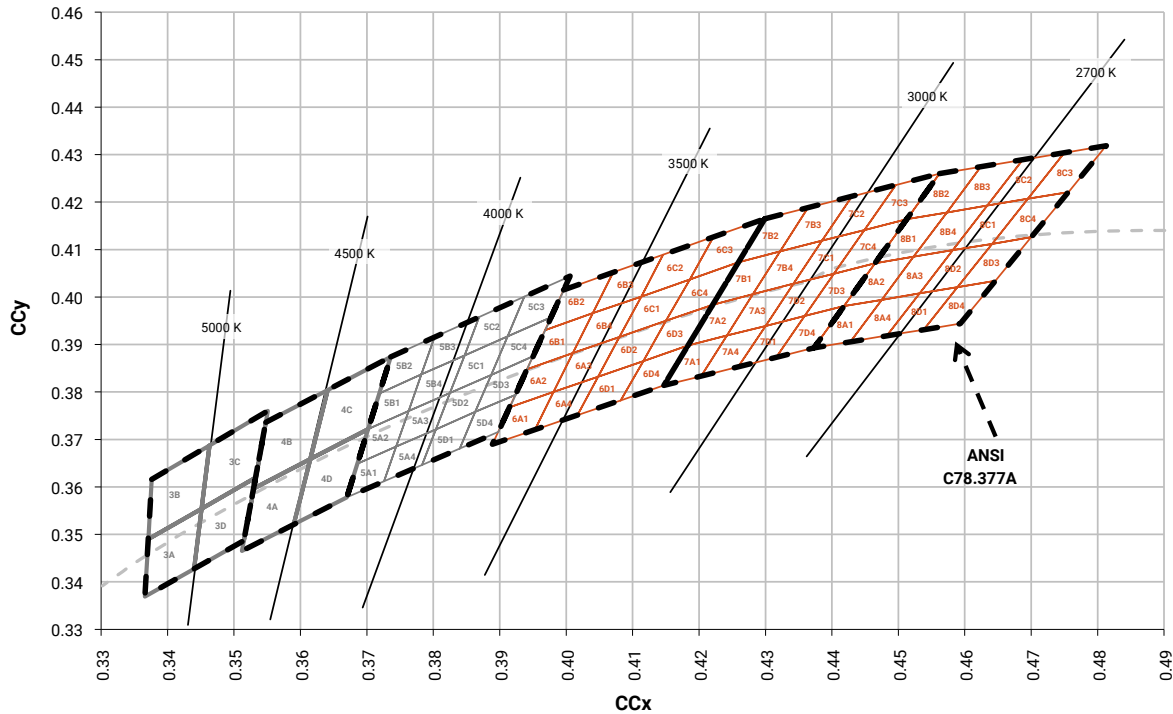

**CREE'S STANDARD CHROMATICITY REGIONS PLOTTED ON THE 1931 CIE CURVE (CONTINUED)**

ANSI Neutral White and ANSI Warm White - XB-E HVW & XB-G HVW

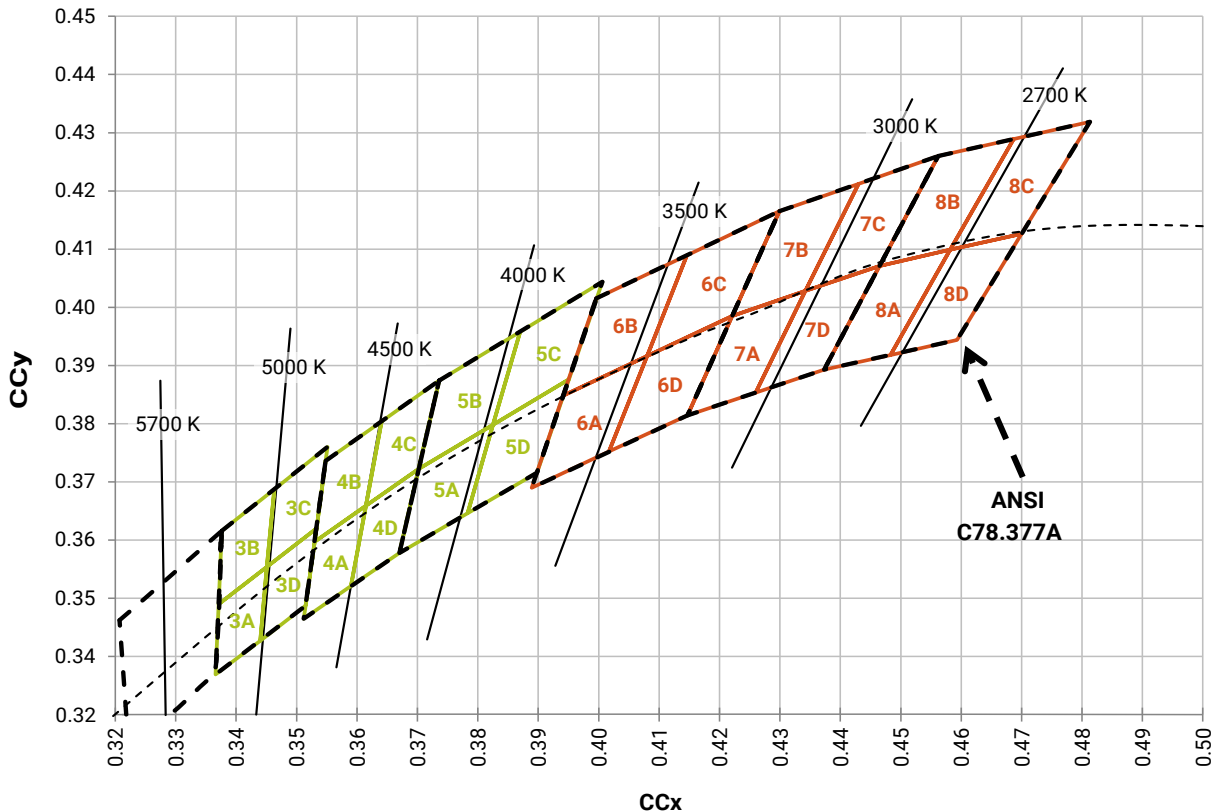

Outdoor White - XB-D & XB-H

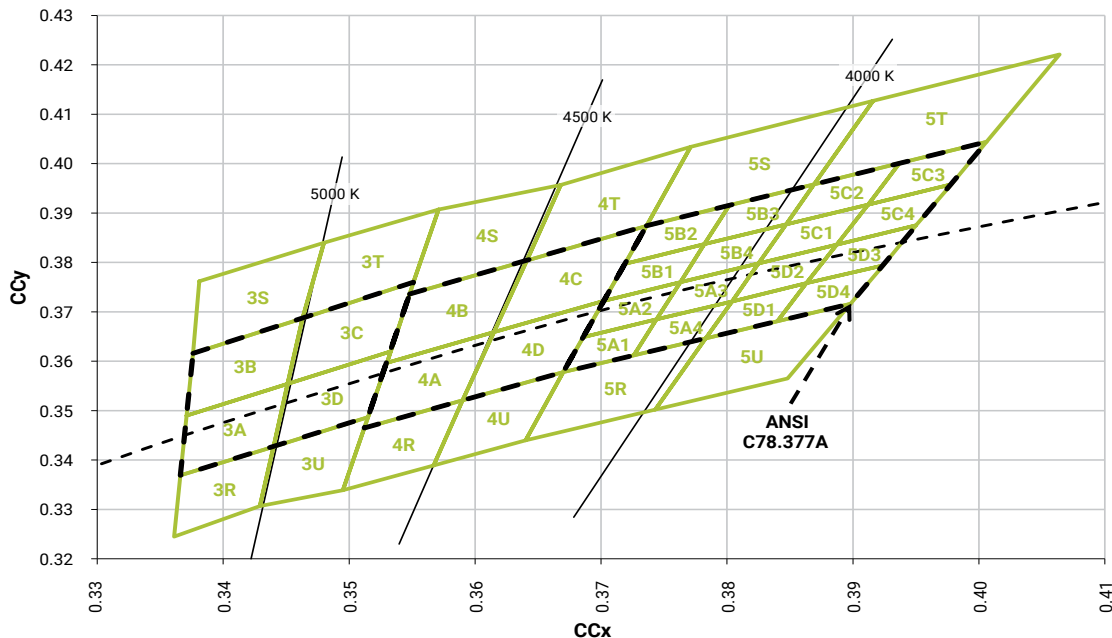

**CREE'S STANDARD COOL WHITE KITS PLOTTED ON ANSI STANDARD CHROMATICITY REGIONS**

**XB-D & XB-H**

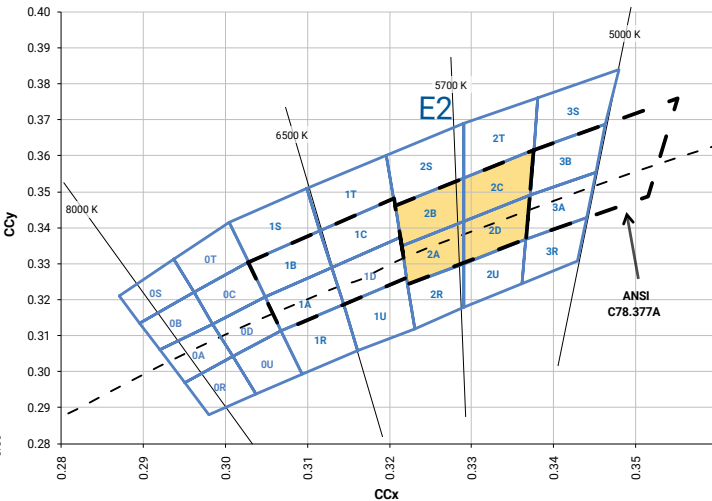
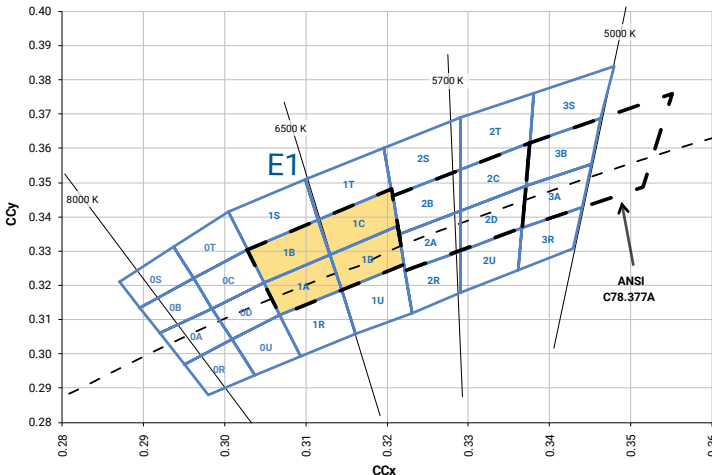
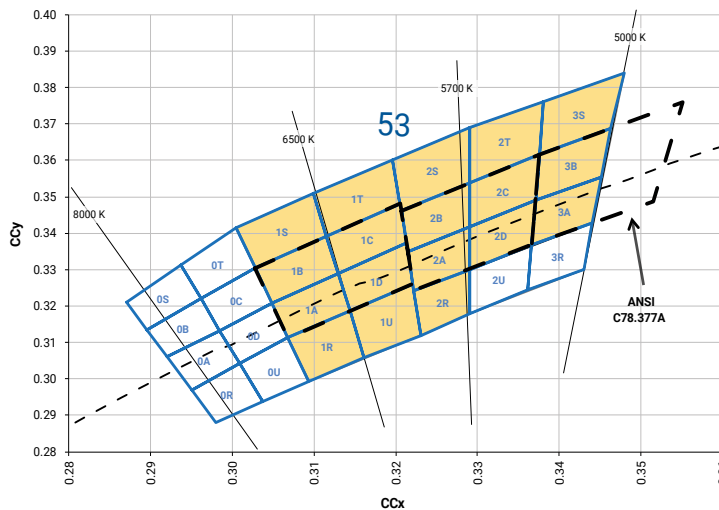
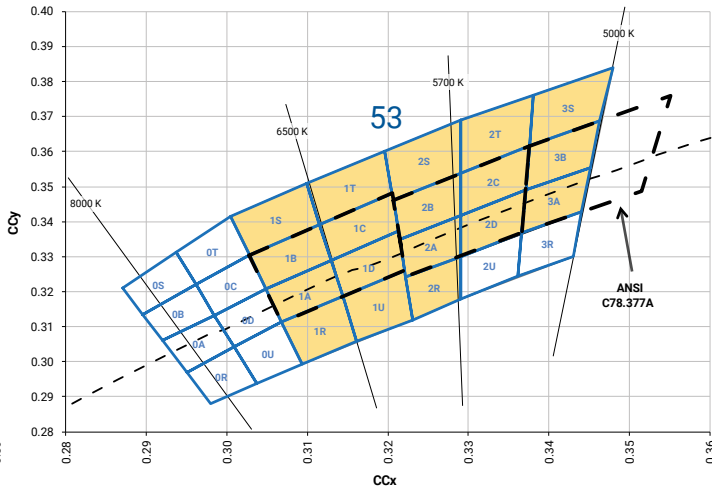
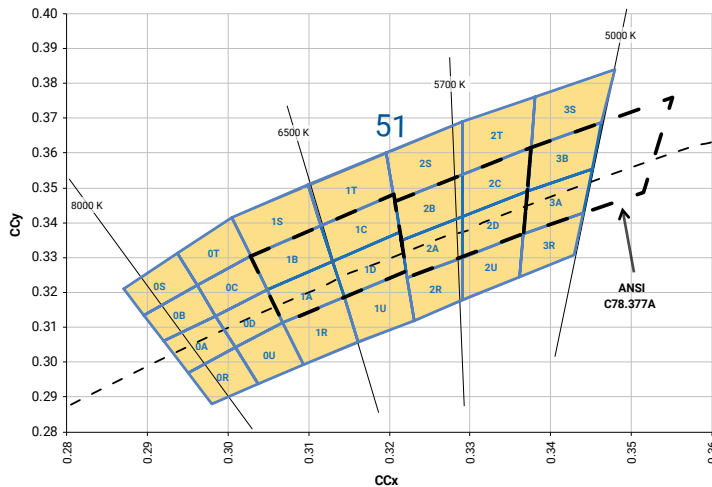

**CREE'S OUTDOOR WHITE KITS PLOTTED ON ANSI STANDARD CHROMATICITY REGIONS**

XB-D & XB-H

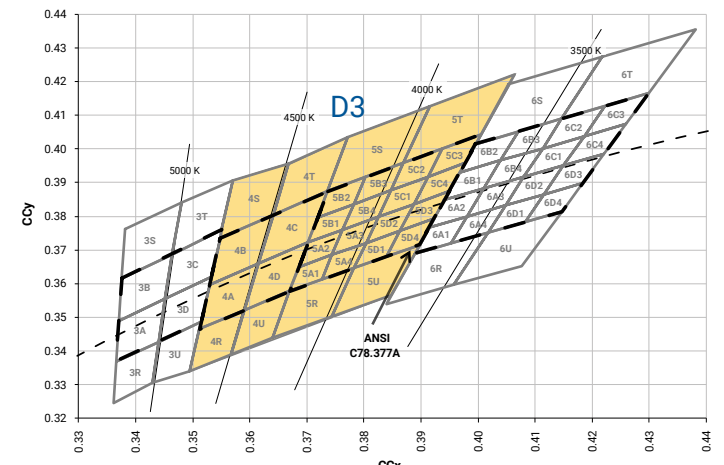
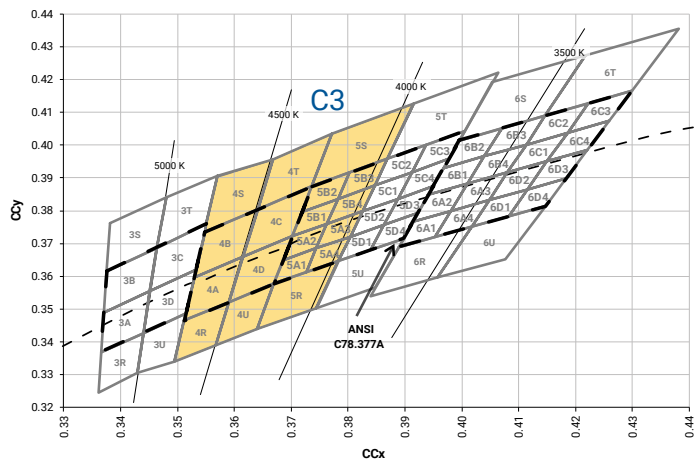
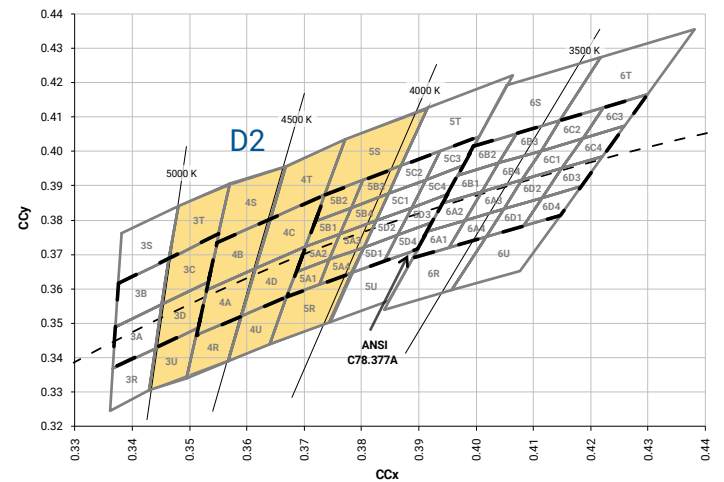
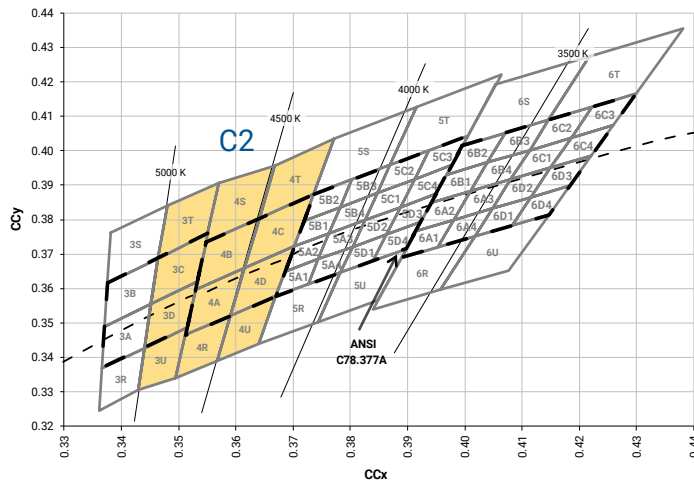
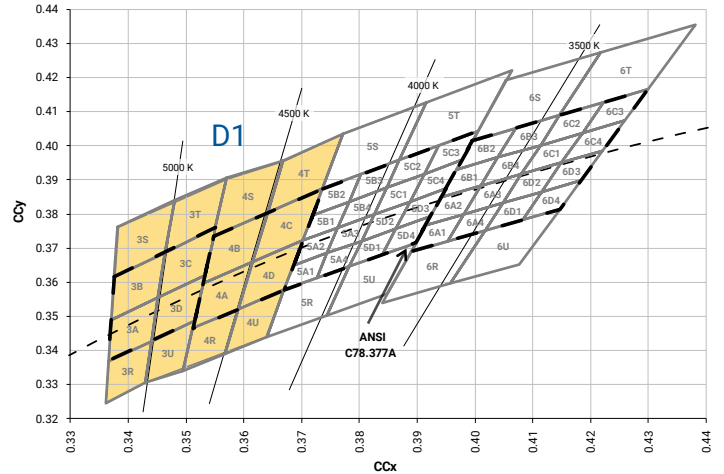
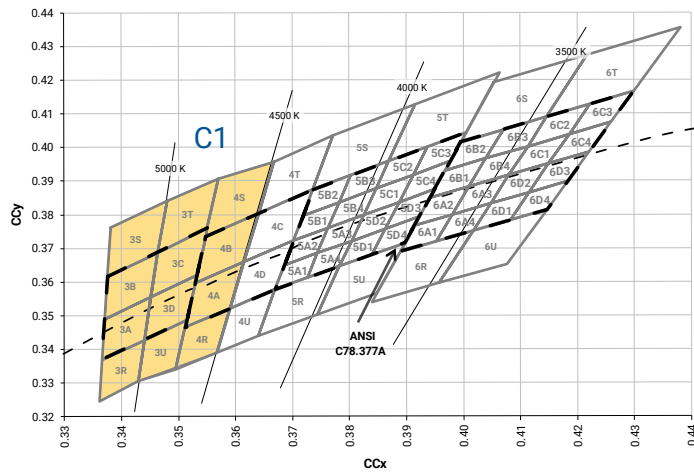

**CREE'S OUTDOOR WHITE KITS PLOTTED ON ANSI STANDARD CHROMATICITY REGIONS - CONTINUED**

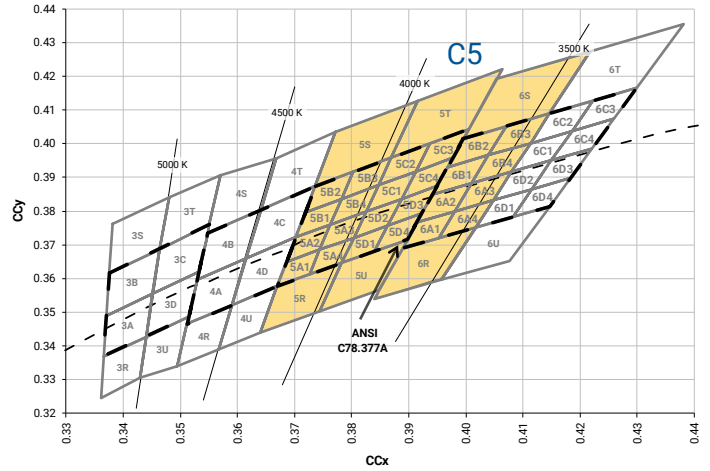
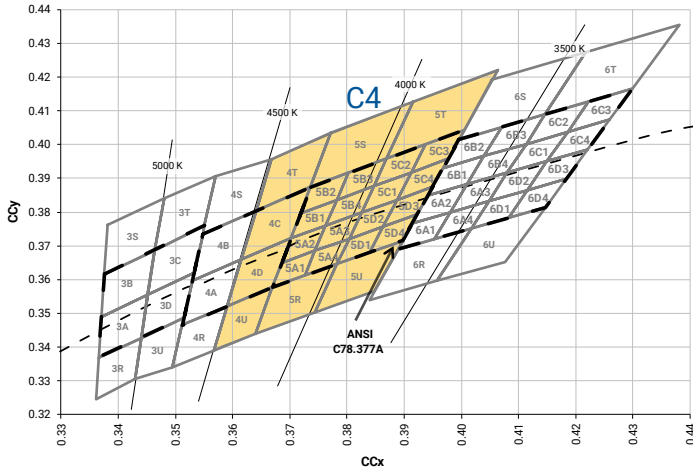

**CREE'S STANDARD WARM AND NEUTRAL WHITE KITS PLOTTED ON ANSI STANDARD CHROMATICITY REGIONS**

XB-D & XB-H

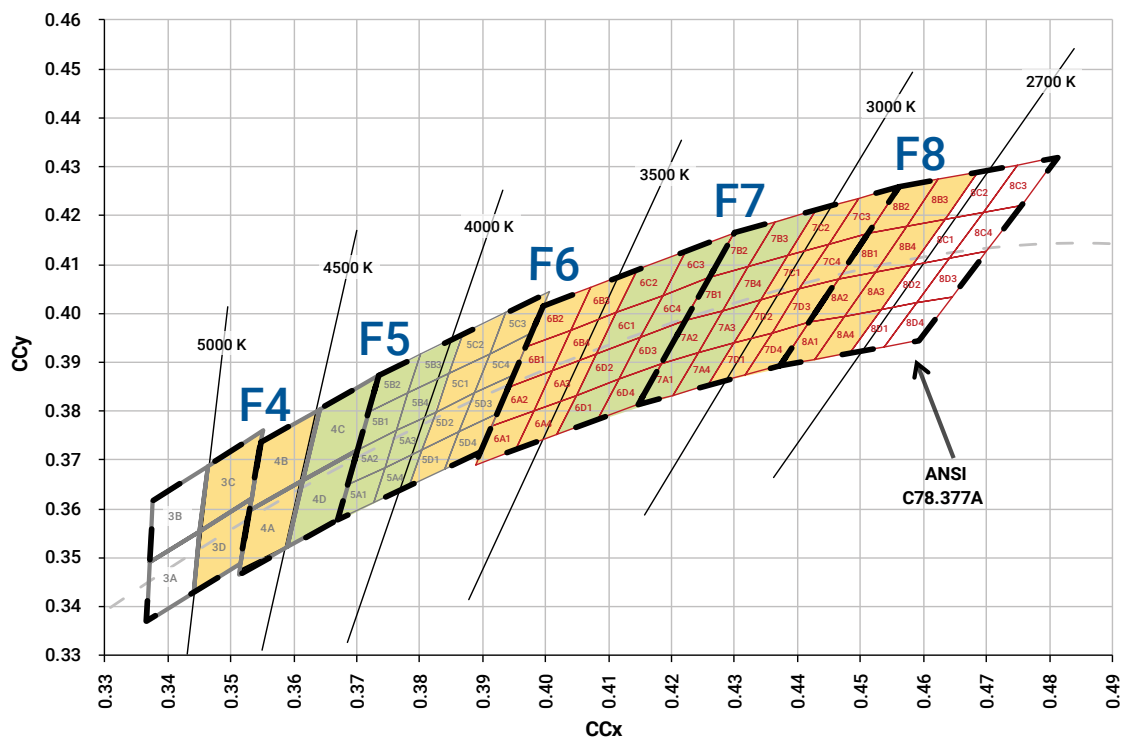
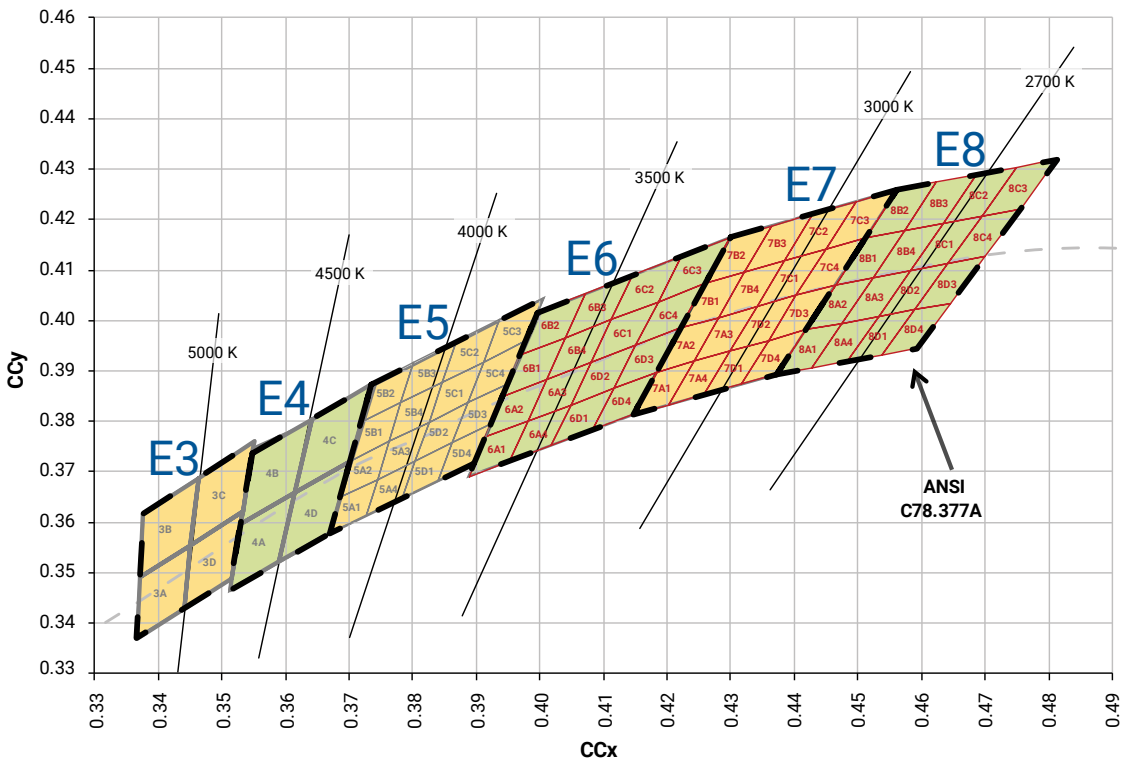

**CREE'S STANDARD CHROMATICITY KITS**

The following table provides the chromaticity bins associated with chromaticity kits, which are specified as part of the order code.

Color	Kit	Chromaticity Bins
Cool White	51	0A, 0B, 0C, 0D, 0R, 0S, 0T, 0U, 1A, 1B, 1C, 1D, 1R, 1S, 1T, 1U, 2A, 2B, 2C, 2D, 2R, 2S, 2T, 2U, 3A, 3B, 3R, 3S
	53	1A, 1B, 1C, 1D, 1R, 1S, 1T, 1U, 2A, 2B, 2C, 2D, 2R, 2S, 2T, 3A, 3B, 3S
	50	1A, 1B, 1C, 1D, 2A, 2B, 2C, 2D
	E1	1A, 1B, 1C, 1D
	E2	2A, 2B, 2C, 2D
Neutral White	E3	3A, 3B, 3C, 3D
	C1	3A, 3B, 3C, 3D, 3R, 3S, 3T, 3U, 4A, 4B, 4R, 4S
	F4	3C, 3D, 4A, 4B
	D1	3A, 3B, 3C, 3D, 3R, 3S, 3T, 3U, 4A, 4B, 4C, 4D, 4R, 4S, 4T, 4U
	E4	4A, 4B, 4C, 4D
	D2	3C, 3D, 3T, 3U, 4A, 4B, 4C, 4D, 4R, 4S, 4T, 4U, 5A1, 5A2, 5A3, 5A4, 5B1, 5B2, 5B3, 5B4, 5R, 5S
	C2	3C, 3D, 3T, 3U, 4A, 4B, 4C, 4D, 4R, 4S, 4T, 4U
	C3	4A, 4B, 4C, 4D, 4R, 4S, 4T, 4U, 5A1, 5A2, 5A3, 5A4, 5B1, 5B2, 5B3, 5B4, 5R, 5S
	D3	4A, 4B, 4C, 4D, 4R, 4S, 4T, 4U, 5A1, 5A2, 5A3, 5A4, 5B1, 5B2, 5B3, 5B4, 5C1, 5C2, 5C3, 5C4, 5D1, 5D2, 5D3, 5D4, 5R, 5S, 5T, 5U
	C4	4C, 4D, 4T, 4U, 5A1, 5A2, 5A3, 5A4, 5B1, 5B2, 5B3, 5B4, 5C1, 5C2, 5C3, 5C4, 5D1, 5D2, 5D3, 5D4, 5R, 5S, 5T, 5U
	F5	4C, 4D, 5A1, 5A2, 5A3, 5A4, 5B1, 5B2, 5B3, 5B4
	E5	5A1, 5A2, 5A3, 5A4, 5B1, 5B2, 5B3, 5B4, 5C1, 5C2, 5C3, 5C4, 5D1, 5D2, 5D3, 5D4
	D4	4C, 4D, 4T, 4U, 5A1, 5A2, 5A3, 5A4, 5B1, 5B2, 5B3, 5B4, 5C1, 5C2, 5C3, 5C4, 5D1, 5D2, 5D3, 5D4, 5R, 5S, 5T, 5U, 6A1, 6A2, 6A3, 6A4, 6B1, 6B2, 6B3, 6B4, 6R, 6S
Z5	5A3, 5B4, 5C1, 5D2	
Warm White	F6	5C1, 5C2, 5C3, 5C4, 5D1, 5D2, 5D3, 5D4, 6A1, 6A2, 6A3, 6A4, 6B1, 6B2, 6B3, 6B4
	D5	5A1, 5A2, 5A3, 5A4, 5B1, 5B2, 5B3, 5B4, 5C1, 5C2, 5C3, 5C4, 5D1, 5D2, 5D3, 5D4, 5R, 5S, 5T, 5U, 6A1, 6A2, 6A3, 6A4, 6B1, 6B2, 6B3, 6B4, 6C1, 6C2, 6C3, 6C4, 6D1, 6D2, 6D3, 6D4, 6R, 6S, 6T, 6U
	C6	5C1, 5C2, 5C3, 5C4, 5D1, 5D2, 5D3, 5D4, 5T, 5U, 6A1, 6A2, 6A3, 6A4, 6B1, 6B2, 6B3, 6B4, 6C1, 6C2, 6C3, 6C4, 6D1, 6D2, 6D3, 6D4, 6R, 6S, 6T, 6U
	E6	6A1, 6A2, 6A3, 6A4, 6B1, 6B2, 6B3, 6B4, 6C1, 6C2, 6C3, 6C4, 6D1, 6D2, 6D3, 6D4
	Z6	6A3, 6B4, 6C1, 6D2
	F7	6C1, 6C2, 6C3, 6C4, 6D1, 6D2, 6D3, 6D4, 7A1, 7A2, 7A3, 7A4, 7B1, 7B2, 7B3, 7B4
	E7	7A1, 7A2, 7A3, 7A4, 7B1, 7B2, 7B3, 7B4, 7C1, 7C2, 7C3, 7C4, 7D1, 7D2, 7D3, 7D4
	Z7	7A3, 7B4, 7C1, 7D2
	F8	7C1, 7C2, 7C3, 7C4, 7D1, 7D2, 7D3, 7D4, 8A1, 8A2, 8A3, 8A4, 8B1, 8B2, 8B3, 8B4
	E8	8A1, 8A2, 8A3, 8A4, 8B1, 8B2, 8B3, 8B4, 8C1, 8C2, 8C3, 8C4, 8D1, 8D2, 8D3, 8D4
Z8	8A3, 8B4, 8C1, 8D2	



**CREE'S STANDARD CHROMATICITY KITS - CONTINUED**

The following table provides the chromaticity bins associated with chromaticity kits for XB-E HVW LEDs.

Color	CCT	Kit	Chromaticity Bins
Neutral White	5000 K	E3	3A, 3B, 3C, 3D
	4750 K	F4	3C, 3D, 4A, 4B
Warm White	3000 K	E7	7A, 7B, 7C, 7D
	2850 K	F8	7C, 7D, 8A, 8B
	2700 K	E8	8A, 8B, 8C, 8D

The following table provides the chromaticity bins associated with chromaticity kits for XB-G HVW LEDs.

Color	CCT	Kit	Chromaticity Bins
Warm White	3000 K	E7	7A, 7B, 7C, 7D
	2850 K	F8	7C, 7D, 8A, 8B
	2700 K	E8	8A, 8B, 8C, 8D

The following tables of order codes list flux minimums and chromaticity regions for the various categories of XLamp XB family LEDs. For other flux and chromaticity combinations, contact Cree or an authorized distributor.

### STANDARD ORDER CODES AND BINS (XB-D ANSI COOL WHITE, $T_j = 85^\circ\text{C}$ )

XLamp XB-D LED Standard Kit Codes - White						
Chromaticity		Minimum Luminous Flux (lm) @ 350 mA*		Order Codes		
Kit	CCT	Code	Flux (lm)	No CRI Minimum	70 CRI Minimum	80 CRI Minimum
ANSI Cool White (5000 K – 8300 K)						
51	6200 K	R3	122	XBDAWT-00-0000-000000F51	XBDAWT-00-0000-000000BF51	
		R2	114	XBDAWT-00-0000-000000E51	XBDAWT-00-0000-000000BE51	
		Q5	107	XBDAWT-00-0000-000000D51	XBDAWT-00-0000-000000BD51	XBDAWT-00-0000-000000HD51
		Q4	100			XBDAWT-00-0000-000000HC51
53	6000 K	R3	122	XBDAWT-00-0000-000000F53	XBDAWT-00-0000-000000BF53	
		R2	114	XBDAWT-00-0000-000000E53	XBDAWT-00-0000-000000BE53	
		Q5	107	XBDAWT-00-0000-000000D53	XBDAWT-00-0000-000000BD53	XBDAWT-00-0000-000000HD53
		Q4	100			XBDAWT-00-0000-000000HC53
50	6200 K	R3	122	XBDAWT-00-0000-000000F50	XBDAWT-00-0000-000000BF50	
		R2	114	XBDAWT-00-0000-000000E50	XBDAWT-00-0000-000000BE50	
		Q5	107	XBDAWT-00-0000-000000D50	XBDAWT-00-0000-000000BD50	XBDAWT-00-0000-000000HD50
		Q4	100			XBDAWT-00-0000-000000HC50
E1	6500 K	R3	122	XBDAWT-00-0000-000000FE1		
		R2	114	XBDAWT-00-0000-000000EE1	XBDAWT-00-0000-000000BEE1	
		Q5	107	XBDAWT-00-0000-000000DE1	XBDAWT-00-0000-000000BDE1	XBDAWT-00-0000-000000HDE1
		Q4	100			XBDAWT-00-0000-000000HCE1
E2	5700 K	R3	122	XBDAWT-00-0000-000000FE2		
		R2	114	XBDAWT-00-0000-000000EE2	XBDAWT-00-0000-000000BEE2	
		Q5	107	XBDAWT-00-0000-000000DE2	XBDAWT-00-0000-000000BDE2	XBDAWT-00-0000-000000HDE2
		Q4	100			XBDAWT-00-0000-000000HCE2

\* Cree XLamp XB Family LED order codes specify only a minimum flux bin and not a maximum. Cree may ship reels in flux bins higher than the minimum specified by the order code without advance notice. Shipments will always adhere to the chromaticity or DWL bin restrictions specified by the order code.

STANDARD ORDER CODES AND BINS (XB-D NEUTRAL WHITE,  $T_j = 85\text{ }^\circ\text{C}$ )

XLamp XB-D LED Standard Kit Codes - White							
Chromaticity		Minimum Luminous Flux (lm) @ 350 mA*		Order Codes			
Kit	CCT	Code	Flux (lm)	No CRI Minimum	70 CRI Minimum	Standard CRI	80 CRI Minimum
ANSI Neutral White (3700 K – 5000 K)							
E3	5000 K	R2	114	XBDAWT-00-0000-000000EE3	XBDAWT-00-0000-000000BEE3	XBDAWT-00-0000-000000LEE3	
		Q5	107	XBDAWT-00-0000-000000DE3	XBDAWT-00-0000-000000BDE3	XBDAWT-00-0000-000000LDE3	XBDAWT-00-0000-000000HDE3
		Q4	100	XBDAWT-00-0000-000000CE3	XBDAWT-00-0000-000000BCE3	XBDAWT-00-0000-000000LCE3	XBDAWT-00-0000-000000HCE3
C1	5000 K	R2	114	XBDAWT-00-0000-000000EC1	XBDAWT-00-0000-000000BEC1	XBDAWT-00-0000-000000LEC1	
		Q5	107	XBDAWT-00-0000-000000DC1	XBDAWT-00-0000-000000BDC1	XBDAWT-00-0000-000000LDC1	
		Q4	100	XBDAWT-00-0000-000000CC1	XBDAWT-00-0000-000000BCC1	XBDAWT-00-0000-000000LCC1	
F4	4750 K	R2	114	XBDAWT-00-0000-000000EF4	XBDAWT-00-0000-000000BEF4	XBDAWT-00-0000-000000LEF4	
		Q5	107	XBDAWT-00-0000-000000DF4	XBDAWT-00-0000-000000BDF4	XBDAWT-00-0000-000000LDF4	XBDAWT-00-0000-000000HDF4
		Q4	100	XBDAWT-00-0000-000000CF4	XBDAWT-00-0000-000000BCF4	XBDAWT-00-0000-000000LCF4	XBDAWT-00-0000-000000HCF4
D1	4750 K	R2	114	XBDAWT-00-0000-000000ED1	XBDAWT-00-0000-000000BED1	XBDAWT-00-0000-000000LED1	
		Q5	107	XBDAWT-00-0000-000000DD1	XBDAWT-00-0000-000000BDD1	XBDAWT-00-0000-000000LDD1	
		Q4	100	XBDAWT-00-0000-000000CD1	XBDAWT-00-0000-000000BCD1	XBDAWT-00-0000-000000LCD1	
E4	4500 K	R2	114	XBDAWT-00-0000-000000EE4	XBDAWT-00-0000-000000BEE4		
		Q5	107	XBDAWT-00-0000-000000DE4	XBDAWT-00-0000-000000BDE4	XBDAWT-00-0000-000000LDE4	XBDAWT-00-0000-000000HDE4
		Q4	100	XBDAWT-00-0000-000000CE4	XBDAWT-00-0000-000000BCE4	XBDAWT-00-0000-000000LCE4	XBDAWT-00-0000-000000HCE4
D2	4500 K	R2	114	XBDAWT-00-0000-000000ED2	XBDAWT-00-0000-000000BED2	XBDAWT-00-0000-000000LED2	
		Q5	107	XBDAWT-00-0000-000000DD2	XBDAWT-00-0000-000000BDD2	XBDAWT-00-0000-000000LDD2	
		Q4	100	XBDAWT-00-0000-000000CD2	XBDAWT-00-0000-000000BCD2	XBDAWT-00-0000-000000LCD2	
C2	4500 K	R2	114	XBDAWT-00-0000-000000EC2	XBDAWT-00-0000-000000BEC2	XBDAWT-00-0000-000000LEC2	
		Q5	107	XBDAWT-00-0000-000000DC2	XBDAWT-00-0000-000000BDC2	XBDAWT-00-0000-000000LDC2	
		Q4	100	XBDAWT-00-0000-000000CC2	XBDAWT-00-0000-000000BCC2	XBDAWT-00-0000-000000LCC2	
C3	4300 K	R2	114	XBDAWT-00-0000-000000EC3	XBDAWT-00-0000-000000BEC3	XBDAWT-00-0000-000000LEC3	
		Q5	107	XBDAWT-00-0000-000000DC3	XBDAWT-00-0000-000000BDC3	XBDAWT-00-0000-000000LDC3	
		Q4	100	XBDAWT-00-0000-000000CC3	XBDAWT-00-0000-000000BCC3	XBDAWT-00-0000-000000LCC3	
F5	4250 K	R2	114	XBDAWT-00-0000-000000EF5	XBDAWT-00-0000-000000BEF5		
		Q5	107	XBDAWT-00-0000-000000DF5	XBDAWT-00-0000-000000BDF5	XBDAWT-00-0000-000000LDF5	XBDAWT-00-0000-000000HDF5
		Q4	100	XBDAWT-00-0000-000000CF5	XBDAWT-00-0000-000000BCF5	XBDAWT-00-0000-000000LCF5	XBDAWT-00-0000-000000HCF5
		Q3	93.9	XBDAWT-00-0000-000000BF5	XBDAWT-00-0000-000000BBF5	XBDAWT-00-0000-000000LBF5	XBDAWT-00-0000-000000HBF5
E5	4000 K	R2	114	XBDAWT-00-0000-000000EE5	XBDAWT-00-0000-000000BEE5		
		Q5	107	XBDAWT-00-0000-000000DE5	XBDAWT-00-0000-000000BDE5	XBDAWT-00-0000-000000LDE5	XBDAWT-00-0000-000000HDE5
		Q4	100	XBDAWT-00-0000-000000CE5	XBDAWT-00-0000-000000BCE5	XBDAWT-00-0000-000000LCE5	XBDAWT-00-0000-000000HCE5
		Q3	93.9	XBDAWT-00-0000-000000BE5	XBDAWT-00-0000-000000BBE5	XBDAWT-00-0000-000000LBE5	XBDAWT-00-0000-000000HBE5

- Typical (Standard) CRI for Neutral White, 3700 K - 5000 K CCT is 75

\* Cree XLamp XB Family LED order codes specify only a minimum flux bin and not a maximum. Cree may ship reels in flux bins higher than the minimum specified by the order code without advance notice. Shipments will always adhere to the chromaticity or DWL bin restrictions specified by the order code.

STANDARD ORDER CODES AND BINS (XB-D WARM WHITE, T<sub>j</sub> = 85 °C)

XLamp XB-D LED Standard Kit Codes - White										
Chromaticity		Minimum Luminous Flux (lm) @ 350 mA*		Order Codes						
Kit	CCT	Code	Flux (lm)	No CRI Minimum	70 CRI Minimum	Standard CRI	80 CRI Minimum	85 CRI Minimum	90 CRI Minimum	
ANSI Warm White (2700 K - 3750 K)										
F6	3750 K	Q5	107	XBDAWT-00-0000-00000DF6	XBDAWT-00-0000-00000BDF6	XBDAWT-00-0000-00000LDF6				
		Q4	100	XBDAWT-00-0000-00000CF6	XBDAWT-00-0000-00000BCF6	XBDAWT-00-0000-00000LCF6	XBDAWT-00-0000-00000HCF6			
		Q3	93.9	XBDAWT-00-0000-00000BF6	XBDAWT-00-0000-00000BBF6	XBDAWT-00-0000-00000LBF6	XBDAWT-00-0000-00000HBF6			
E6	3500 K	Q5	107	XBDAWT-00-0000-00000DE6	XBDAWT-00-0000-00000BDE6	XBDAWT-00-0000-00000LDE6				
		Q4	100	XBDAWT-00-0000-00000CE6	XBDAWT-00-0000-00000BCE6	XBDAWT-00-0000-00000LCE6	XBDAWT-00-0000-00000HCE6			
		Q3	93.9	XBDAWT-00-0000-00000BE6	XBDAWT-00-0000-00000BBE6	XBDAWT-00-0000-00000LBE6	XBDAWT-00-0000-00000HBE6			
F7	3250 K	Q5	107	XBDAWT-00-0000-00000DF7	XBDAWT-00-0000-00000BDF7					
		Q4	100	XBDAWT-00-0000-00000CF7	XBDAWT-00-0000-00000BCF7	XBDAWT-00-0000-00000LCF7	XBDAWT-00-0000-00000HCF7			
		Q3	93.9	XBDAWT-00-0000-00000BF7	XBDAWT-00-0000-00000BBF7	XBDAWT-00-0000-00000LBF7	XBDAWT-00-0000-00000HBF7			
		Q2	87.4	XBDAWT-00-0000-00000AF7	XBDAWT-00-0000-00000BAF7	XBDAWT-00-0000-00000LAF7	XBDAWT-00-0000-00000HAF7			
		P4	80.6					XBDAWT-00-0000-00000P9F7		
		P3	73.9					XBDAWT-00-0000-00000P8F7	XBDAWT-00-0000-00000U8F7	
		P2	67.2					XBDAWT-00-0000-00000P7F7	XBDAWT-00-0000-00000U7F7	
E7	3000 K	Q5	107	XBDAWT-00-0000-00000DE7	XBDAWT-00-0000-00000BDE7					
		Q4	100	XBDAWT-00-0000-00000CE7	XBDAWT-00-0000-00000BCE7	XBDAWT-00-0000-00000LCE7	XBDAWT-00-0000-00000HCE7			
		Q3	93.9	XBDAWT-00-0000-00000BE7	XBDAWT-00-0000-00000BBE7	XBDAWT-00-0000-00000LBE7	XBDAWT-00-0000-00000HBE7			
		Q2	87.4	XBDAWT-00-0000-00000AE7	XBDAWT-00-0000-00000BAE7	XBDAWT-00-0000-00000LAE7	XBDAWT-00-0000-00000HAE7			
		P4	80.6					XBDAWT-00-0000-00000P9E7		
		P3	73.9					XBDAWT-00-0000-00000P8E7	XBDAWT-00-0000-00000U8E7	
		P2	67.2					XBDAWT-00-0000-00000P7E7	XBDAWT-00-0000-00000U7E7	

\* Cree XLamp XB Family LED order codes specify only a minimum flux bin and not a maximum. Cree may ship reels in flux bins higher than the minimum specified by the order code without advance notice. Shipments will always adhere to the chromaticity or DWL bin restrictions specified by the order code.

STANDARD ORDER CODES AND BINS (XB-D WARM WHITE, T<sub>j</sub> = 85 °C) - CONTINUED

XLamp XB-D LED Standard Kit Codes - White									
Chromaticity		Minimum Luminous Flux (lm) @ 350 mA*		Order Codes					
Kit	CCT	Code	Flux (lm)	No CRI Minimum	70 CRI Minimum	Standard CRI	80 CRI Minimum	85 CRI Minimum	90 CRI Minimum
ANSI Warm White (2700 K - 3750 K)									
F8	2850 K	Q4	100	XBDAWT-00-0000-000000CF8	XBDAWT-00-0000-00000BCF8				
		Q3	93.9	XBDAWT-00-0000-000000BF8	XBDAWT-00-0000-00000BBF8	XBDAWT-00-0000-00000LBF8	XBDAWT-00-0000-00000HBF8		
		Q2	87.4	XBDAWT-00-0000-000000AF8	XBDAWT-00-0000-00000BAF8	XBDAWT-00-0000-00000LAF8	XBDAWT-00-0000-00000HAF8		
		P4	80.6			XBDAWT-00-0000-00000L9F8	XBDAWT-00-0000-00000H9F8		
		P3	73.9					XBDAWT-00-0000-00000P8F8	XBDAWT-00-0000-00000U8F8
		P2	67.2					XBDAWT-00-0000-00000P7F8	XBDAWT-00-0000-00000U7F8
E8	2700 K	Q4	100	XBDAWT-00-0000-000000CE8	XBDAWT-00-0000-00000BCE8				
		Q3	93.9	XBDAWT-00-0000-000000BE8	XBDAWT-00-0000-00000BBE8	XBDAWT-00-0000-00000LBE8	XBDAWT-00-0000-00000HBE8		
		Q2	87.4	XBDAWT-00-0000-000000AE8	XBDAWT-00-0000-00000BAE8	XBDAWT-00-0000-00000LAE8	XBDAWT-00-0000-00000HAE8		
		P4	80.6			XBDAWT-00-0000-00000L9E8	XBDAWT-00-0000-00000H9E8		
		P3	73.9					XBDAWT-00-0000-00000P8E8	XBDAWT-00-0000-00000U8E8
		P2	67.2					XBDAWT-00-0000-00000P7E8	XBDAWT-00-0000-00000U7E8

- Typical (Standard) CRI for Warm White, 2600 K - 3700 K CCT is 80.

\* Cree XLamp XB Family LED order codes specify only a minimum flux bin and not a maximum. Cree may ship reels in flux bins higher than the minimum specified by the order code without advance notice. Shipments will always adhere to the chromaticity or DWL bin restrictions specified by the order code.

STANDARD ORDER CODES AND BINS (XB-D COLOR,  $T_j = 25\text{ }^\circ\text{C}$ )

XLamp XB-D LED Standard Kit Codes - Royal Blue				
Royal Blue		Minimum Radiant Flux (mW) @ 350 mA*		Order Codes
Kit	Dominant Wavelength (nm)	Code	Flux (mW)	
01	450 - 465	34	550	XBDROY-00-0000-000000N01
		33	525	XBDROY-00-0000-000000M01
		32	500	XBDROY-00-0000-000000L01
		31	475	XBDROY-00-0000-000000K01
		30	450	XBDROY-00-0000-000000J01
02	450 - 460	34	550	XBDROY-00-0000-000000N02
		33	525	XBDROY-00-0000-000000M02
		32	500	XBDROY-00-0000-000000L02
		31	475	XBDROY-00-0000-000000K02
		30	450	XBDROY-00-0000-000000J02
03	455 - 465	33	525	XBDROY-00-0000-000000M03
		32	500	XBDROY-00-0000-000000L03
		31	475	XBDROY-00-0000-000000K03
		30	450	XBDROY-00-0000-000000J03
04	450 - 455	34	550	XBDROY-00-0000-000000N04
		33	525	XBDROY-00-0000-000000M04
		32	500	XBDROY-00-0000-000000L04
		31	475	XBDROY-00-0000-000000K04
		30	450	XBDROY-00-0000-000000J04
05	455 - 460	33	525	XBDROY-00-0000-000000M05
		32	500	XBDROY-00-0000-000000L05
		31	475	XBDROY-00-0000-000000K05
		30	450	XBDROY-00-0000-000000J05
06	460 - 465	32	500	XBDROY-00-0000-000000L06
		31	475	XBDROY-00-0000-000000K06
		30	450	XBDROY-00-0000-000000J06
07	452.5 - 457.5	33	525	XBDROY-00-0000-000000M07
		32	500	XBDROY-00-0000-000000L07
		31	475	XBDROY-00-0000-000000K07
		30	450	XBDROY-00-0000-000000J07
08	457.5 - 462.5	32	500	XBDROY-00-0000-000000L08
		31	475	XBDROY-00-0000-000000K08
		30	450	XBDROY-00-0000-000000J08
09	452.5 - 462.5	33	525	XBDROY-00-0000-000000M09
		32	500	XBDROY-00-0000-000000L09
		31	475	XBDROY-00-0000-000000K09
		30	450	XBDROY-00-0000-000000J09

\* Cree XLamp XB Family LED order codes specify only a minimum flux bin and not a maximum. Cree may ship reels in flux bins higher than the minimum specified by the order code without advance notice. Shipments will always adhere to the chromaticity or DWL bin restrictions specified by the order code.

**STANDARD ORDER CODES AND BINS (XB-D COLOR, T<sub>j</sub> = 25 °C, CONTINUED)**

XLamp XB-D LED Standard Kit Codes - Blue				
Blue		Minimum Luminous Flux (lm) @ 350 mA*		Order Codes
Kit	Dominant Wavelength (nm)	Code	Flux (lm)	
01	465 - 485	M2	39.8	XBDBLU-00-0000-000000201
		K3	35.2	XBDBLU-00-0000-000000Z01
		K2	30.6	XBDBLU-00-0000-000000Y01
02	465 - 480	M2	39.8	XBDBLU-00-0000-000000202
		K3	35.2	XBDBLU-00-0000-000000Z02
		K2	30.6	XBDBLU-00-0000-000000Y02
05	470 - 480	M2	39.8	XBDBLU-00-0000-000000205
		K3	35.2	XBDBLU-00-0000-000000Z05
		K2	30.6	XBDBLU-00-0000-000000Y05

XLamp XB-D LED Standard Kit Codes - Green				
Green		Minimum Luminous Flux (lm) @ 350 mA*		Order Codes
Kit	Dominant Wavelength (nm)	Code	Flux (lm)	
01	520 - 535	Q5	107	XBDGRN-00-0000-000000D01
		Q4	100	XBDGRN-00-0000-000000C01
		Q3	93.9	XBDGRN-00-0000-000000B01
		Q2	87.4	XBDGRN-00-0000-000000A01
02	520 - 530	Q5	107	XBDGRN-00-0000-000000D02
		Q4	100	XBDGRN-00-0000-000000C02
		Q3	93.9	XBDGRN-00-0000-000000B02
		Q2	87.4	XBDGRN-00-0000-000000A02
03	525 - 535	Q5	107	XBDGRN-00-0000-000000D03
		Q4	100	XBDGRN-00-0000-000000C03
		Q3	93.9	XBDGRN-00-0000-000000B03
		Q2	87.4	XBDGRN-00-0000-000000A03

\* Cree XLamp XB Family LED order codes specify only a minimum flux bin and not a maximum. Cree may ship reels in flux bins higher than the minimum specified by the order code without advance notice. Shipments will always adhere to the chromaticity or DWL bin restrictions specified by the order code.

**STANDARD ORDER CODES AND BINS (XB-D COLOR, T<sub>j</sub> = 25 °C, CONTINUED)**

XLamp XB-D LED Standard Kit Codes - Amber				
Amber		Minimum Luminous Flux (lm) @ 350 mA*		Order Codes
Kit	Dominant Wavelength (nm)	Code	Flux (lm)	
01	585 - 595	P3	73.9	XBDAMB-00-0000-000000801
		P2	67.2	XBDAMB-00-0000-000000701
		N4	62	XBDAMB-00-0000-000000601
		N3	56.8	XBDAMB-00-0000-000000501
03	590 - 595	P3	73.9	XBDAMB-00-0000-000000803
		P2	67.2	XBDAMB-00-0000-000000703
		N4	62	XBDAMB-00-0000-000000603
		N3	56.8	XBDAMB-00-0000-000000503

XLamp XB-D LED Standard Kit Codes - Red-Orange				
Red-Orange		Minimum Luminous Flux (lm) @ 350 mA*		Order Codes
Kit	Dominant Wavelength (nm)	Code	Flux (lm)	
01	610 - 620	Q4	100	XBDRDO-00-0000-000000C01
		Q3	93.9	XBDRDO-00-0000-000000B01
		Q2	87.4	XBDRDO-00-0000-000000A01
		P4	80.6	XBDRDO-00-0000-000000901
		P3	73.9	XBDRDO-00-0000-000000801
02	610 - 615	Q4	100	XBDRDO-00-0000-000000C02
		Q3	93.9	XBDRDO-00-0000-000000B02
		Q2	87.4	XBDRDO-00-0000-000000A02
		P4	80.6	XBDRDO-00-0000-000000902
		P3	73.9	XBDRDO-00-0000-000000802
03	615 - 620	Q3	93.9	XBDRDO-00-0000-000000B03
		Q2	87.4	XBDRDO-00-0000-000000A03
		P4	80.6	XBDRDO-00-0000-000000903
		P3	73.9	XBDRDO-00-0000-000000803

\* Cree XLamp XB Family LED order codes specify only a minimum flux bin and not a maximum. Cree may ship reels in flux bins higher than the minimum specified by the order code without advance notice. Shipments will always adhere to the chromaticity or DWL bin restrictions specified by the order code.



**STANDARD ORDER CODES AND BINS (XB-D COLOR, T<sub>j</sub> = 25 °C, CONTINUED)**

XLamp XB-D LED Standard Kit Codes - Red				
Red		Minimum Luminous Flux (lm) @ 350 mA*		Order Codes
Kit	Dominant Wavelength (nm)	Code	Flux (lm)	
01	620 - 630	P3	73.9	XBDRED-00-0000-000000801
		P2	67.2	XBDRED-00-0000-000000701
		N4	62	XBDRED-00-0000-000000601
		N3	56.8	XBDRED-00-0000-000000501
		N2	51.7	XBDRED-00-0000-000000401
02	620 - 625	P3	73.9	XBDRED-00-0000-000000802
		P2	67.2	XBDRED-00-0000-000000702
		N4	62	XBDRED-00-0000-000000602
		N3	56.8	XBDRED-00-0000-000000502
		N2	51.7	XBDRED-00-0000-000000402

\* Cree XLamp XB Family LED order codes specify only a minimum flux bin and not a maximum. Cree may ship reels in flux bins higher than the minimum specified by the order code without advance notice. Shipments will always adhere to the chromaticity or DWL bin restrictions specified by the order code.

**STANDARD ORDER CODES AND BINS (XB-E HVW NEUTRAL WHITE,  $T_j = 85^\circ\text{C}$ )**

XLamp XB-E HVW LED Standard Kit Codes - White				
Chromaticity		Minimum Luminous Flux (lm) @ 44 mA*		Order Codes
Kit	CCT	Code	Flux (lm)	80 CRI Minimum
ANSI Neutral White (3700 K – 5000 K)				
E3	5000 K	R3	122	XBEHVW-H0-0000-00000HFE3
		R2	114	XBEHVW-H0-0000-00000HEE3
		Q5	107	XBEHVW-H0-0000-00000HDE3
F4	4750 K	R3	122	XBEHVW-H0-0000-00000HFF4
		R2	114	XBEHVW-H0-0000-00000HEF4
		Q5	107	XBEHVW-H0-0000-00000HDF4

**STANDARD ORDER CODES AND BINS (XB-E HVW WARM WHITE,  $T_j = 85^\circ\text{C}$ )**

XLamp XB-E HVW LED Standard Kit Codes - White				
Chromaticity		Minimum Luminous Flux (lm) @ 44 mA*		Order Codes
Kit	CCT	Code	Flux (lm)	80 CRI Minimum
ANSI Warm White (2700 K - 3750 K)				
E7	3000 K	Q4	100	XBEHVW-H0-0000-00000HCE7
		Q3	93.9	XBEHVW-H0-0000-00000HBE7
		Q2	87.4	XBEHVW-H0-0000-00000HAE7
F8	2850 K	Q4	100	XBEHVW-H0-0000-00000HCF8
		Q3	93.9	XBEHVW-H0-0000-00000HBF8
		Q2	87.4	XBEHVW-H0-0000-00000HAF8
E8	2700 K	Q4	100	XBEHVW-H0-0000-00000HCE8
		Q3	93.9	XBEHVW-H0-0000-00000HBE8
		Q2	87.4	XBEHVW-H0-0000-00000HAE8

\* Cree XLamp XB Family LED order codes specify only a minimum flux bin and not a maximum. Cree may ship reels in flux bins higher than the minimum specified by the order code without advance notice. Shipments will always adhere to the chromaticity or DWL bin restrictions specified by the order code.

**STANDARD ORDER CODES AND BINS (XB-G HVW WARM WHITE,  $T_j = 85\text{ }^\circ\text{C}$ )**

XLamp XB-G HVW LED Standard Kit Codes - White				
Chromaticity		Minimum Luminous Flux (lm) @ 44 mA*		Order Codes
Kit	CCT	Code	Flux (lm)	80 CRI Minimum
ANSI Warm White (2700 K - 3750 K)				
E7	3000 K	Q5	107	XBGHVW-H0-0000-00000HDE7
		Q4	100	XBGHVW-H0-0000-00000HCE7
		Q3	93.9	XBGHVW-H0-0000-00000HBE7
F8	2850 K	Q5	107	XBGHVW-H0-0000-00000HDF8
		Q4	100	XBGHVW-H0-0000-00000HCF8
		Q3	93.9	XBGHVW-H0-0000-00000HBF8
E8	2700 K	Q5	107	XBGHVW-H0-0000-00000HDE8
		Q4	100	XBGHVW-H0-0000-00000HCE8
		Q3	93.9	XBGHVW-H0-0000-00000HBE8

\* Cree XLamp XB Family LED order codes specify only a minimum flux bin and not a maximum. Cree may ship reels in flux bins higher than the minimum specified by the order code without advance notice. Shipments will always adhere to the chromaticity or DWL bin restrictions specified by the order code.

**STANDARD ORDER CODES AND BINS (XB-H ANSI COOL WHITE,  $T_j = 85\text{ }^\circ\text{C}$ )**

XLamp XB-H LED Standard Kit Codes - White				
Chromaticity		Minimum Luminous Flux (lm) @ 700 mA*		Order Codes
Kit	CCT	Code	Flux (lm)	Standard CRI
ANSI Cool White (5000 K – 8300 K)				
51	6000 K	T6	280	XBHAWT-00-0000-000LT6051
		T5	260	XBHAWT-00-0000-000LT5051
		T4	240	XBHAWT-00-0000-000LT4051
		T3	220	XBHAWT-00-0000-000LT3051
53	5700 K	T6	280	XBHAWT-00-0000-000LT6053
		T5	260	XBHAWT-00-0000-000LT5053
		T4	240	XBHAWT-00-0000-000LT4053
		T3	220	XBHAWT-00-0000-000LT3053
50	6000 K	T6	280	XBHAWT-00-0000-000LT6050
		T5	260	XBHAWT-00-0000-000LT5050
		T4	240	XBHAWT-00-0000-000LT4050
		T3	220	XBHAWT-00-0000-000LT3050
E1	6500 K	T6	280	XBHAWT-00-0000-000LT60E1
		T5	260	XBHAWT-00-0000-000LT50E1
		T4	240	XBHAWT-00-0000-000LT40E1
		T3	220	XBHAWT-00-0000-000LT30E1
E2	5700 K	T6	280	XBHAWT-00-0000-000LT60E2
		T5	260	XBHAWT-00-0000-000LT50E2
		T4	240	XBHAWT-00-0000-000LT40E2
		T3	220	XBHAWT-00-0000-000LT30E2

\* Cree XLamp XB Family LED order codes specify only a minimum flux bin and not a maximum. Cree may ship reels in flux bins higher than the minimum specified by the order code without advance notice. Shipments will always adhere to the chromaticity or DWL bin restrictions specified by the order code.

STANDARD ORDER CODES AND BINS (XB-H NEUTRAL WHITE,  $T_j = 85^\circ\text{C}$ )

XLamp XB-H LED Standard Kit Codes - White						
Chromaticity		Minimum Luminous Flux (lm) @ 700 mA*		Order Codes		
Kit	CCT	Code	Flux (lm)	No CRI Minimum	Standard CRI	80 CRI Minimum
ANSI Neutral White (3700 K – 5000 K)						
E3	5000 K	T6	280	XBHAWT-00-0000-0000T60E3	XBHAWT-00-0000-000LT60E3	
		T5	260	XBHAWT-00-0000-0000T50E3	XBHAWT-00-0000-000LT50E3	
		T4	240	XBHAWT-00-0000-0000T40E3	XBHAWT-00-0000-000LT40E3	
		T3	220	XBHAWT-00-0000-0000T30E3	XBHAWT-00-0000-000LT30E3	
C1	5000 K	T6	280	XBHAWT-00-0000-0000T60C1		
		T5	260	XBHAWT-00-0000-0000T50C1		
		T4	240	XBHAWT-00-0000-0000T40C1		
		T3	220	XBHAWT-00-0000-0000T30C1		
F4	4750 K	T6	280	XBHAWT-00-0000-0000T60F4		
		T5	260	XBHAWT-00-0000-0000T50F4	XBHAWT-00-0000-000LT50F4	
		T4	240	XBHAWT-00-0000-0000T40F4	XBHAWT-00-0000-000LT40F4	
		T3	220	XBHAWT-00-0000-0000T30F4	XBHAWT-00-0000-000LT30F4	
D1	4750 K	T6	280	XBHAWT-00-0000-0000T60D1		
		T5	260	XBHAWT-00-0000-0000T50D1		
		T4	240	XBHAWT-00-0000-0000T40D1		
		T3	220	XBHAWT-00-0000-0000T30D1		
C2	4750 K	T6	280	XBHAWT-00-0000-0000T60C2		
		T5	260	XBHAWT-00-0000-0000T50C2		
		T4	240	XBHAWT-00-0000-0000T40C2		
		T3	220	XBHAWT-00-0000-0000T30C2		
E4	4500 K	T6	280	XBHAWT-00-0000-0000T60E4		
		T5	260	XBHAWT-00-0000-0000T50E4	XBHAWT-00-0000-000LT50E4	
		T4	240	XBHAWT-00-0000-0000T40E4	XBHAWT-00-0000-000LT40E4	
		T3	220	XBHAWT-00-0000-0000T30E4	XBHAWT-00-0000-000LT30E4	
D2	4500 K	T6	280	XBHAWT-00-0000-0000T60D2		
		T5	260	XBHAWT-00-0000-0000T50D2		
		T4	240	XBHAWT-00-0000-0000T40D2		
		T3	220	XBHAWT-00-0000-0000T30D2		
C3	4500 K	T6	280	XBHAWT-00-0000-0000T60C3		
		T5	260	XBHAWT-00-0000-0000T50C3		
		T4	240	XBHAWT-00-0000-0000T40C3		
		T3	220	XBHAWT-00-0000-0000T30C3		
D3	4300 K	T6	280	XBHAWT-00-0000-0000T60D3		
		T5	260	XBHAWT-00-0000-0000T50D3		
		T4	240	XBHAWT-00-0000-0000T40D3		
		T3	220	XBHAWT-00-0000-0000T30D3		

\* Cree XLamp XB Family LED order codes specify only a minimum flux bin and not a maximum. Cree may ship reels in flux bins higher than the minimum specified by the order code without advance notice. Shipments will always adhere to the chromaticity or DWL bin restrictions specified by the order code.

STANDARD ORDER CODES AND BINS (XB-H NEUTRAL WHITE,  $T_j = 85\text{ }^\circ\text{C}$ ) - CONTINUED

XLamp XB-H LED Standard Kit Codes - White						
Chromaticity		Minimum Luminous Flux (lm) @ 700 mA*		Order Codes		
Kit	CCT	Code	Flux (lm)	No CRI Minimum	Standard CRI	80 CRI Minimum
ANSI Neutral White (3700 K – 5000 K)						
C4	4300 K	T6	280	XBHAWT-00-0000-0000T60C4		
		T5	260	XBHAWT-00-0000-0000T50C4		
		T4	240	XBHAWT-00-0000-0000T40C4		
		T3	220	XBHAWT-00-0000-0000T30C4		
F5	4300 K	T6	280	XBHAWT-00-0000-0000T60F5		
		T5	260	XBHAWT-00-0000-0000T50F5	XBHAWT-00-0000-000LT50F5	
		T4	240	XBHAWT-00-0000-0000T40F5	XBHAWT-00-0000-000LT40F5	
		T3	220	XBHAWT-00-0000-0000T30F5	XBHAWT-00-0000-000LT30F5	
E5	4000 K	T6	280	XBHAWT-00-0000-0000T60E5		
		T5	260	XBHAWT-00-0000-0000T50E5	XBHAWT-00-0000-000LT50E5	
		T4	240	XBHAWT-00-0000-0000T40E5	XBHAWT-00-0000-000LT40E5	XBHAWT-00-0000-000HT40E5
		T3	220	XBHAWT-00-0000-0000T30E5	XBHAWT-00-0000-000LT30E5	XBHAWT-00-0000-000HT30E5
D4	4000 K	T6	280	XBHAWT-00-0000-0000T60D4		
		T5	260	XBHAWT-00-0000-0000T50D4		
		T4	240	XBHAWT-00-0000-0000T40D4		
		T3	220	XBHAWT-00-0000-0000T30D4		
C5	4000 K	T6	280	XBHAWT-00-0000-0000T60C5		
		T5	260	XBHAWT-00-0000-0000T50C5		
		T4	240	XBHAWT-00-0000-0000T40C5		
		T3	220	XBHAWT-00-0000-0000T30C5		
Z5	4000 K	T4	240		XBHAWT-00-0000-000LT40Z5	XBHAWT-00-0000-000HT40Z5
		T3	220		XBHAWT-00-0000-000LT30Z5	XBHAWT-00-0000-000HT30Z5

\* Cree XLamp XB Family LED order codes specify only a minimum flux bin and not a maximum. Cree may ship reels in flux bins higher than the minimum specified by the order code without advance notice. Shipments will always adhere to the chromaticity or DWL bin restrictions specified by the order code.

STANDARD ORDER CODES AND BINS (XB-H WARM WHITE,  $T_j = 85\text{ }^\circ\text{C}$ )

XLamp XB-H LED Standard Kit Codes - White									
Chromaticity		Minimum Luminous Flux (lm) @ 700 mA*		Order Codes					
Kit	CCT	Code	Flux (lm)	No CRI Minimum	Standard CRI	80 CRI Minimum	85 CRI Minimum	90 CRI Minimum	
ANSI Warm White (2700 K - 3750 K)									
F6	3700 K	T5	260	XBHAWT-00-0000-0000T50F6					
		T4	240	XBHAWT-00-0000-0000T40F6	XBHAWT-00-0000-000LT40F6	XBHAWT-00-0000-000HT40F6			
		T3	220	XBHAWT-00-0000-0000T30F6	XBHAWT-00-0000-000LT30F6	XBHAWT-00-0000-000HT30F6			
		T2	200	XBHAWT-00-0000-0000T20F6	XBHAWT-00-0000-000LT20F6	XBHAWT-00-0000-000HT20F6			
D5	3700 K	T6	280	XBHAWT-00-0000-0000T60D5					
		T5	260	XBHAWT-00-0000-0000T50D5					
		T4	240	XBHAWT-00-0000-0000T40D5					
		T3	220	XBHAWT-00-0000-0000T30D5					
C6	3700 K	T5	260	XBHAWT-00-0000-0000T50C6					
		T4	240	XBHAWT-00-0000-0000T40C6					
		T3	220	XBHAWT-00-0000-0000T30C6					
E6	3500 K	T5	260	XBHAWT-00-0000-0000T50E6					
		T4	240	XBHAWT-00-0000-0000T40E6	XBHAWT-00-0000-000LT40E6	XBHAWT-00-0000-000HT40E6			
		T3	220	XBHAWT-00-0000-0000T30E6	XBHAWT-00-0000-000LT30E6	XBHAWT-00-0000-000HT30E6			
		T2	200	XBHAWT-00-0000-0000T20E6	XBHAWT-00-0000-000LT20E6	XBHAWT-00-0000-000HT20E6			
Z6	3500 K	T4	240		XBHAWT-00-0000-000LT40Z6				
		T3	220		XBHAWT-00-0000-000LT30Z6	XBHAWT-00-0000-000HT30Z6			
		T2	200		XBHAWT-00-0000-000LT20Z6	XBHAWT-00-0000-000HT20Z6			
F7	3200 K	T5	260	XBHAWT-00-0000-0000T50F7					
		T4	240	XBHAWT-00-0000-0000T40F7	XBHAWT-00-0000-000LT40F7				
		T3	220	XBHAWT-00-0000-0000T30F7	XBHAWT-00-0000-000LT30F7	XBHAWT-00-0000-000HT30F7			
		T2	200	XBHAWT-00-0000-0000T20F7	XBHAWT-00-0000-000LT20F7	XBHAWT-00-0000-000HT20F7			

\* Cree XLamp XB Family LED order codes specify only a minimum flux bin and not a maximum. Cree may ship reels in flux bins higher than the minimum specified by the order code without advance notice. Shipments will always adhere to the chromaticity or DWL bin restrictions specified by the order code.

STANDARD ORDER CODES AND BINS (XB-H WARM WHITE, T<sub>j</sub> = 85 °C) - CONTINUED

XLamp XB-H LED Standard Kit Codes - White										
Chromaticity		Minimum Luminous Flux (lm) @ 700 mA*		Order Codes						
Kit	CCT	Code	Flux (lm)	No CRI Minimum	Standard CRI	80 CRI Minimum	85 CRI Minimum	90 CRI Minimum		
ANSI Warm White (2700 K - 3750 K)										
E7	3000 K	T5	260	XBHAWT-00-0000-0000T50E7						
		T4	240	XBHAWT-00-0000-0000T40E7	XBHAWT-00-0000-000LT40E7					
		T3	220	XBHAWT-00-0000-0000T30E7	XBHAWT-00-0000-000LT30E7	XBHAWT-00-0000-000HT30E7				
		T2	200	XBHAWT-00-0000-0000T20E7	XBHAWT-00-0000-000LT20E7	XBHAWT-00-0000-000HT20E7	XBHAWT-00-0000-000PT20E7			
		S6	182				XBHAWT-00-0000-000PS60E7	XBHAWT-00-0000-000US60E7		
		S5	172					XBHAWT-00-0000-000PS50E7	XBHAWT-00-0000-000US50E7	
		S4	164						XBHAWT-00-0000-000US40E7	
Z7	3000 K	T3	220		XBHAWT-00-0000-000LT30Z7	XBHAWT-00-0000-000HT30Z7				
		T2	200		XBHAWT-00-0000-000LT20Z7	XBHAWT-00-0000-000HT20Z7				
		S6	182				XBHAWT-00-0000-000PS60Z7	XBHAWT-00-0000-000US60Z7		
		S5	172				XBHAWT-00-0000-000PS50Z7	XBHAWT-00-0000-000US50Z7		
		S4	164					XBHAWT-00-0000-000US40Z7		
F8	2850 K	T3	220		XBHAWT-00-0000-000LT30F8	XBHAWT-00-0000-000HT30F8				
		T2	200		XBHAWT-00-0000-000LT20F8	XBHAWT-00-0000-000HT20F8				
		S6	182		XBHAWT-00-0000-000LS60F8	XBHAWT-00-0000-000HS60F8	XBHAWT-00-0000-000PS60F8	XBHAWT-00-0000-000US60F8		
		S5	172				XBHAWT-00-0000-000PS50F8	XBHAWT-00-0000-000US50F8		
		S4	164				XBHAWT-00-0000-000PS40F8	XBHAWT-00-0000-000US40F8		
E8	2700 K	T3	220		XBHAWT-00-0000-000LT30E8	XBHAWT-00-0000-000HT30E8				
		T2	200		XBHAWT-00-0000-000LT20E8	XBHAWT-00-0000-000HT20E8				
		S6	182		XBHAWT-00-0000-000LS60E8	XBHAWT-00-0000-000HS60E8	XBHAWT-00-0000-000PS60E8	XBHAWT-00-0000-000US60E8		
		S5	172				XBHAWT-00-0000-000PS50E8	XBHAWT-00-0000-000US50E8		
		S4	164				XBHAWT-00-0000-000PS40E8	XBHAWT-00-0000-000US40E8		

\* Cree XLamp XB Family LED order codes specify only a minimum flux bin and not a maximum. Cree may ship reels in flux bins higher than the minimum specified by the order code without advance notice. Shipments will always adhere to the chromaticity or DWL bin restrictions specified by the order code.



**STANDARD ORDER CODES AND BINS (XB-H WARM WHITE, T<sub>j</sub> = 85 °C) - CONTINUED**

XLamp XB-H LED Standard Kit Codes - White								
Chromaticity		Minimum Luminous Flux (lm) @ 700 mA*		Order Codes				
Kit	CCT	Code	Flux (lm)	No CRI Minimum	Standard CRI	80 CRI Minimum	85 CRI Minimum	90 CRI Minimum
ANSI Warm White (2700 K - 3750 K)								
Z8	2700 K	T2	200		XBHAWT-00-0000-000LT20Z8	XBHAWT-00-0000-000HT20Z8		
		S6	182		XBHAWT-00-0000-000LS60Z8	XBHAWT-00-0000-000HS60Z8	XBHAWT-00-0000-000PS60Z8	
		S5	172				XBHAWT-00-0000-000PS50Z8	XBHAWT-00-0000-000US50Z8
		S4	164				XBHAWT-00-0000-000PS40Z8	XBHAWT-00-0000-000US40Z8

\* Cree XLamp XB Family LED order codes specify only a minimum flux bin and not a maximum. Cree may ship reels in flux bins higher than the minimum specified by the order code without advance notice. Shipments will always adhere to the chromaticity or DWL bin restrictions specified by the order code.