

# HIGH VOLTAGE DC SWITCHING RELAY

## 1 POLE - 20 / 30A

### FTR-E1 Series

#### ■ FEATURES

- 450VDC – 20/30A high voltage DC load switching.
- Non polarized contacts. Switchable for charge/discharge circuit.
- Low coil power consumption (0.9W at coil rated voltage)
- High insulation.
  - Between coil and contact: 5,000VAC, 1 minute.
  - Between open contact: 2,500VDC, 1 minute.
- cULus recognized types are available.
- Plastic material: UL flammability 94V-0.
- Plastic sealed.

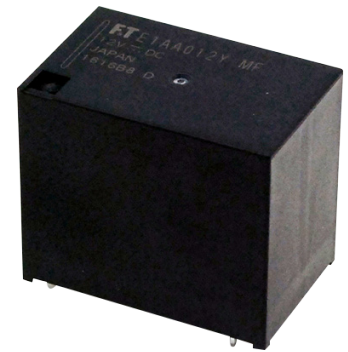

#### ■ Applications

- On board electrical vehicles charger system and plug-in hybrid vehicles
- String disconnecting of photovoltaics systems
- Charge and discharge of power storage system
- High voltage DC load control system

#### ■ Part Numbers

[Example]    FTR-E1    A    A    012    Y    -    MF  
                   (a)        (b)        (c)        (d)        (e)        (f)

(a)	Relay type	FTR-E1	: FTR-E1 series
(b)	Contact configuration	A	: 1a (1 form X)
(c)	Power consumption	A	: Standard (900mW)
(d)	Coil voltage	012 024	: 12VDC : 24VDC
(e)	Contact material	Y	: Silver alloy
(f)	Special type	MF GR HA	: Standard (20A) :cULus recognized (20A) :cULus recognized (30A)

Note: The designation name is stamped on the top of the relay case as follows:

Example: Ordering part number: FTR-E1AA012Y-MF

Stamped on part number: E1AA012Y-MF

# FTR-E1 Series

## ■ Specifications

Item			FTR-E1		Remarks / conditions
			20A type (-MF, -GR)	30A type (-HA)	
Contact data	Configuration		1a (1 form X)		
	Material		Silver alloy		
	Construction		Single contact		
	Contact rating		20A, 450VDC	30A, 450VDC	Resistive
	Voltage drop		Max. 0.5V at 20A		Initial
	Continuous carrying current		25A (85°C, cable size 5.5mm <sup>2</sup> ) 30A (70°C, cable size 8mm <sup>2</sup> ) 40A (40°C, cable size 8mm <sup>2</sup> )		Please refer to characteristic data
	Max. carrying current		40A / 1 hour (85°C, cable size 8mm <sup>2</sup> )		
	Min. switching load		1A 6VDC		Reference *1
Coil	Rated power consumption		900mW		At 20°C
	Operate power consumption		324mW		At 20°C
	Operating temperature range		-40°C ~ +85°C		No frost
Time	Operate		Max. 30ms (without bounce)		At 20°C, nominal voltage
	Release		Max. 10ms (without diode, without bounce)		
Life	Mechanical		1 x 10 <sup>6</sup> operations		18.000 operations / hour
	Electrical		75 x 10 <sup>3</sup> operations		10A, 450VDC resistive, with varistor *2
			10 x 10 <sup>3</sup> operations		20A, 450VDC resistive, with varistor *2
			-	5 x 10 <sup>3</sup> operations	30A, 450VDC resistive, with varistor *2
			100 x 10 <sup>3</sup> operations		20A, 450VDC inrush only (without break)
Insulation	Insulation resistance		1000MΩ		At 1000VDC
	Dielectric withstanding voltage	Open contacts	2,500VAC(50/60Hz), 1 minute		
		Coil contact	5,000VAC(50/60Hz), 1 minute		
Other	Vibration resistance	Misoperation	5~200Hz, 45m/s <sup>2</sup> , constant acceleration		Sense time 1ms, contact ON/OFF
		Endurance	5~200Hz, 45m/s <sup>2</sup> , constant acceleration		Contact ON/OFF, up/down 4hours, left/right/front/back each 2 hours
	Shock resistance	Misoperation	300m/s <sup>2</sup> (11±1ms, contact ON) 200m/s <sup>2</sup> (11±1ms, contact OFF)		Sense time 1ms
		Endurance	1,000m/s <sup>2</sup> (6±1ms)		Contact ON/OFF total 36 times
	Dimensions / weight		43.6×28.3×36.8 mm / approx. 75g		

Note: Electrical characteristics mentioned above are the values at JIS standard condition (temperature 15 to 35degC, relative humidity 25 to 75%, atmospheric pressure 86k to 106kPa) unless otherwise specified.

Note: Care shall be taken on the heat generated on PC board when maximum carrying current exceeds 10A.

Please perform the confirmation test with actual conditions.

\*1: Minimum switching loads mentioned above are reference values. Please perform the confirmation test with actual load before production since reference values may vary according to switching frequencies, environmental conditions and expected reliability levels.

\*2: Electrical life at resistive load mentioned above are the values when a varistor is used as coil suppression device. Using protection device other than varistor, the contact life expectancy may decrease drastically.

# FTR-E1 Series

## ■ Coil Data

Coil code	Rated Coil Voltage (VDC)	Coil Resistance +/-10% ( $\Omega$ )	Must Operate Voltage* (VDC)	Must Release Voltage* (VDC)
012	12	160	7.2 (20°C) 9.0 (85°C)	1.0 (20°C) 1.3 (85°C)
024	24	640	14.4 (20°C) 18.0 (85°C)	2.0 (20°C) 2.6 (85°C)

Note: All values in the table are valid at 20degC and zero contact current unless otherwise specified.

Note: Coil polarity must be applied as specified in schematics.

\*: Specified operated values are valid for pulse wave voltage.

## ■ Safety Standards

Type	Compliance	Contact Rating
cULus	UL508 C22.2 No.14-13 (File No. E63615)	[FTR-E1AA Y-GR] 10A, 450VDC (resistive) 85°C 20A, 450VDC (resistive) 85°C [FTR-E1AA Y-HA] 10A, 450VDC (resistive) 85°C 20A, 450VDC (resistive) 85°C 30A, 450VDC (resistive) 85°C

## ■ Dimensions

- Dimensions

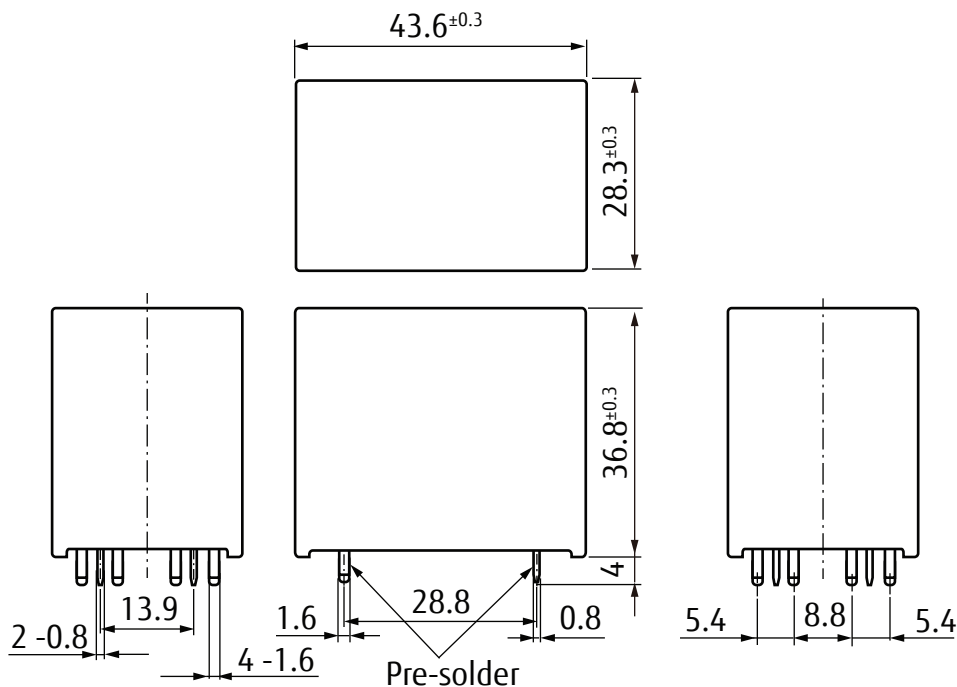

Note: Dimensions of the terminals do not include thickness of pre-solder.

# FTR-E1 Series

- Schematics  
(BOTTOM VIEW)

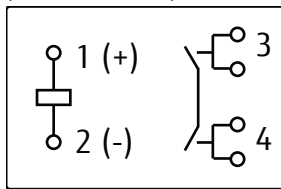

- PC Board Mounting Hole Layout  
(BOTTOM VIEW)

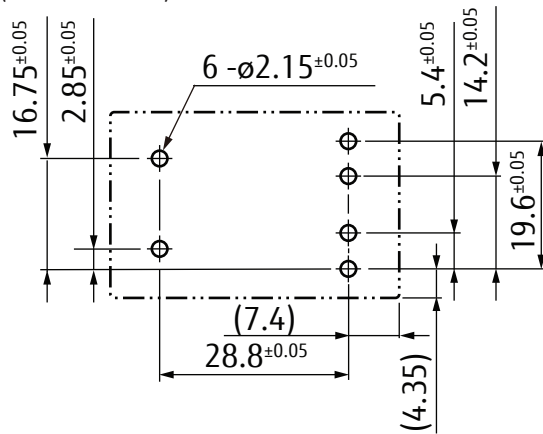

( ): Reference value  
Unit: mm

## Characteristic Data (Reference)

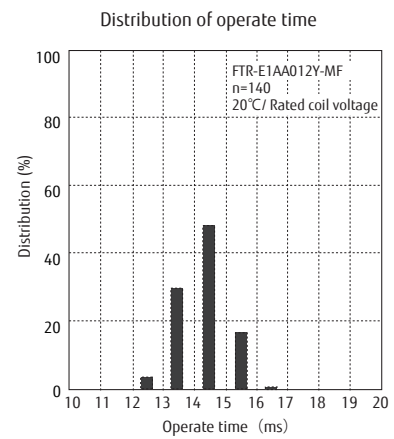
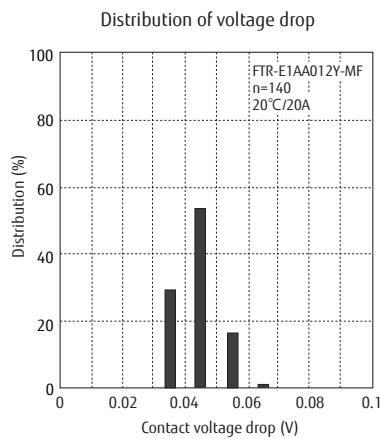
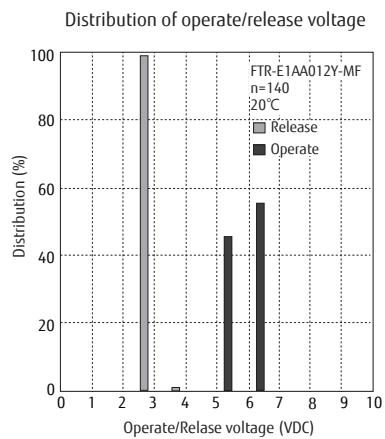

# FTR-E1 Series

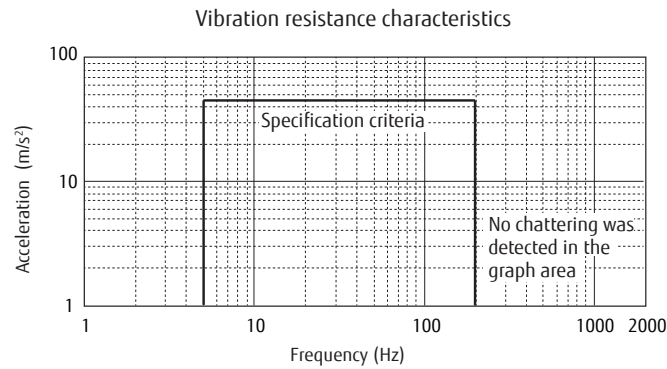
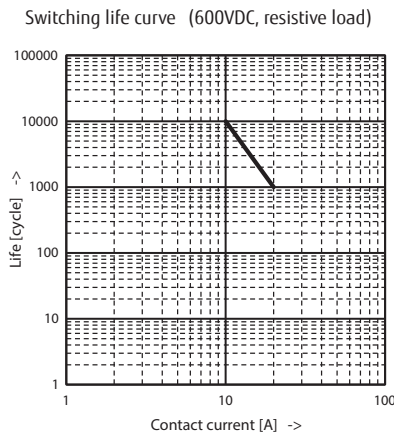
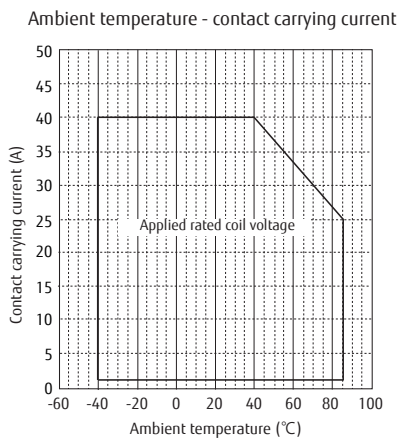
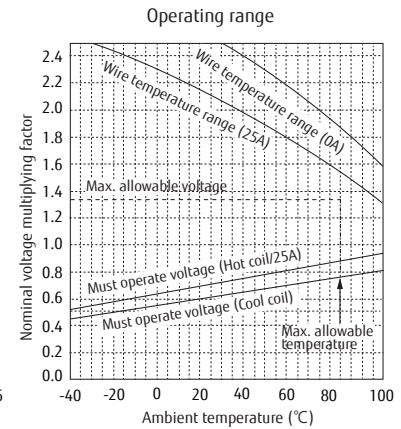
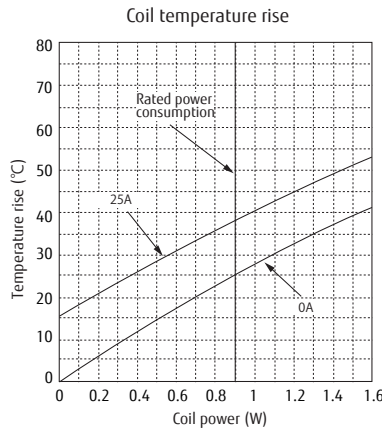
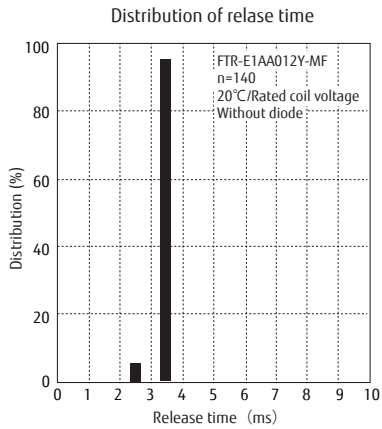

Test material: coil energized and de-energized  
Direction of vibration: see diagram below  
Detection level: chatter > 1 ms

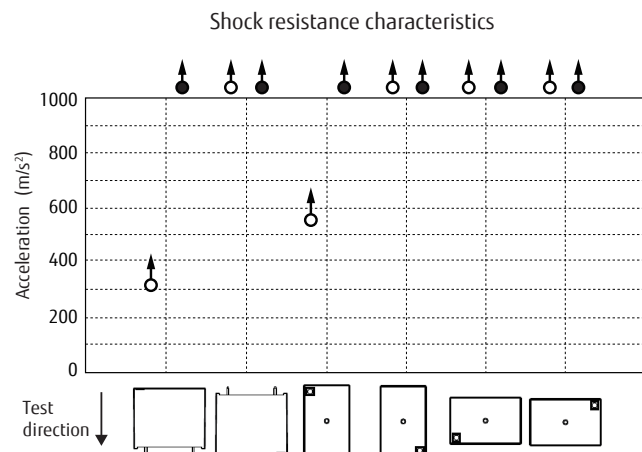
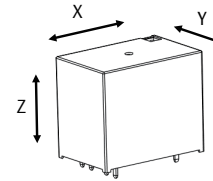

Test material: coil energized and de-energized  
Shock duration: 11ms (490m/s<sup>2</sup> or less)  
6ms (more than 490m/s<sup>2</sup>)  
Test direction: see diagram under the graph  
Detection level: chatter > 1ms

- : Coil de-energized
- : Coil energized

---

# FTR-E1 Series

---

## ■ Important notes

- High voltage DC switching relay
  - There is a possibility that the relay is not able to switch off the load at high voltage DC load. Fail safe circuit must be provided to prevent injury, fire or other harms resulting from failure occurred on relays
  - Relays are periodic maintenance parts. Do not exceed the specified life time and/or switching conditions.
- Specifications
  - All values mentioned in this datasheet are based on ideal conditions. Please perform the confirmation test before actual use.
  - Reflow soldering is prohibited.
  - Care shall be taken on coil polarity
- Environment
  - Do not use relays in the atmosphere with sulfurizing gas or nitric oxide. Contact resistance may increase.
  - Do not use silicon or silicon-containing product near relays. It may cause contact failure.

# FTR-E1 Series

## GENERAL INFORMATION

### 1. RoHS Compliance

- All relays produced by Fujitsu Components are compliant with RoHS directive 2011/65/EU including amendments.
- Use of Cadmium in electrical contacts is exempted as per Annex III of the RoHS directive 2001/65/EU. Please consider expiry date of exemption. Relays with Cadmium containing contacts are not to be used for new designs.
- All relays are lead-free. Please refer to Lead-Free Status Info for older date codes at: <http://www.fujitsu.com/downloads/MICRO/fcai/relays/lead-free-letter.pdf>

### 2. Recommended lead free solder condition

- Lead free solder plating on relay terminals is Sn-3.0Ag-0.5Cu, unless otherwise specified. This material has been verified to be compatible with PbSn assembly process.
- Recommended solder for assembly: Sn-3.0Ag-0.5Cu.

#### Flow Solder Condition:

Pre-heating: maximum 120°C  
within 90 sec.  
Soldering: dip within 5 sec. at  
255°C ± 5°C solder bath  
Relay must be cooled by air immediately  
after soldering

#### Solder by Soldering Iron:

Soldering Iron 30-60W  
Temperature: maximum 350-360°C  
Duration: maximum 3 sec.

**We highly recommend that you confirm your actual solder conditions**

### 3. Moisture Sensitivity

- Moisture Sensitivity Level standard is not applicable to electromechanical relays, unless otherwise indicated.

### 4. Tin Whiskers

- Dipped SnAgCu solder is known as presenting a low risk to tin whisker development. No considerable length whisker was found by our in house test.

# FTR-E1 Series

## Fujitsu Components International Headquarter Offices

<b>Japan</b> FUJITSU COMPONENT LIMITED Shinagawa Seaside Park Tower 19F, 12-4, Higashi-shinagawa 4-chome, Shinagawa-ku, Tokyo, 140-0002, Japan Tel: (81-3) 3450-1682 Fax: (81-3) 3474-2385 Email: fcl-contact@cs.jp.fujitsu.com Web: www.fujitsu.com/jp/fcl/	<b>Asia Pacific</b> FUJITSU COMPONENTS ASIA, LTD. 102E Pasir Panjang Road #01-01 Citilink Warehouse Complex Singapore 118529 Tel: (65) 6375-8560 Fax: (65) 6273-3021 Email: fcal@sg.fujitsu.com Web: www.fujitsu.com/sg/products/devices/components	<b>Korea</b> FUJITSU COMPONENTS KOREA LIMITED Alpha Tower #403, 645 Sampoong-dong, Bundang-gu, Seongnam-si, Gyeonggi-do, 13524 Korea Tel: (82) 31-708-7108 Fax: (82) 31-709-7108 Email: fcal@sg.fujitsu.com www.fujitsu.com/sg/products/devices/components/
<b>North and South America</b> FUJITSU COMPONENTS AMERICA, INC 2290 North First Street, Suite 212 San Jose, CA 95131, USA Tel: (1-408) 745-4900 Fax: (1-408) 745-4970 Email: components@us.fujitsu.com Web: us.fujitsu.com/components	<b>China</b> FUJITSU ELECTRONIC COMPONENTS (SHANGHAI) CO., LTD. Unit 4306, InterContinental Center 100 Yu Tong Road, Shanghai 200070, China Tel: (86-21) 3253 0998 Fax: (86-21) 3253 0997 Email: fcal@sg.fujitsu.com Web: www.fujitsu.com/sg/products/devices/components	
<b>Europe</b> FUJITSU COMPONENTS EUROPE B.V. Diamantlaan 25 2132 WV Hoofddorp Netherlands Tel: (31-23) 5560910 Fax: (31-23) 5560950 Email: info@fceu.fujitsu.com Web: www.fujitsu.com/uk/components	<b>Hong Kong</b> FUJITSU COMPONENTS HONG KONG CO., LTD Unit 506, Inter-Continental Plaza No.94 Granville Road, Tsim Sha Tsui, Kowloon, Hong Kong Tel: (852) 2881-8495 Tex: (852) 2894-9512 Email: fcal@sg.fujitsu.com Web: www.fujitsu.com/sg/products/devices/components/	

©2017 Fujitsu Components Europe B.V. All rights reserved. All trademarks or registered trademarks are the property of their respective owners.

The contents, data and information in this datasheet are provided by Fujitsu Component Ltd. as a service only to its user and only for general information purposes.

The use of the contents, data and information provided in this datasheet is at the users' own risk.

Fujitsu has assembled this datasheet with care and will endeavor to keep the contents, data and information correct, accurate, comprehensive, complete and up to date.

Fujitsu Components Europe B.V. and affiliated companies do however not accept any responsibility or liability on their behalf, nor on behalf of its employees, for any loss or damage, direct, indirect or consequential, with respect to this datasheet, its contents, data, and information and related graphics and the correctness, reliability, accuracy, comprehensiveness, usefulness, availability and completeness thereof.

Nor do Fujitsu Components Europe B.V. and affiliated companies accept on their behalf, nor on behalf of its employees, any responsibility or liability for any representation or warrant of any kind, express or implied, including warranties of any kind for merchantability or fitness for particular use, with respect to these datasheets, its contents, data, information and related graphics and the correctness, reliability, accuracy, comprehensiveness, usefulness, availability and completeness thereof. Rev. February 06<sup>th</sup>, 2017



# Mouser Electronics

Authorized Distributor

Click to View Pricing, Inventory, Delivery & Lifecycle Information:

Fujitsu:

[FTR-E1AA024Y-MF](#) [FTR-E1AA012Y-MF](#) [FTR-E1AA024Y-HA](#) [FTR-E1AA012Y-GR](#) [FTR-E1AA012Y-HA](#) [FTR-E1AA024Y-GR](#)