

MC74LCX00

Low-Voltage CMOS Quad 2-Input NAND Gate

With 5 V-Tolerant Inputs

The MC74LCX00 is a high performance, quad 2-input NAND gate operating from a 2.3 to 3.6 V supply. High impedance TTL compatible inputs significantly reduce current loading to input drivers while TTL compatible outputs offer improved switching noise performance. A V_I specification of 5.5 V allows MC74LCX00 inputs to be safely driven from 5 V devices.

Current drive capability is 24 mA at the outputs.

Features

- Designed for 2.3 V to 3.6 V V_{CC} Operation
- 5 V Tolerant Inputs – Interface Capability With 5 V TTL Logic
- LVTTTL Compatible
- LVC MOS Compatible
- 24 mA Balanced Output Sink and Source Capability
- Near Zero Static Supply Current (10 μ A) Substantially Reduces System Power Requirements
- Latchup Performance Exceeds 500 mA
- ESD Performance: Human Body Model >2000 V
Machine Model >200 V
- NLV Prefix for Automotive and Other Applications Requiring Unique Site and Control Change Requirements; AEC-Q100 Qualified and PPAP Capable
- These Devices are Pb-Free, Halogen Free/BFR Free and are RoHS Compliant



ON Semiconductor®

<http://onsemi.com>

MARKING DIAGRAMS

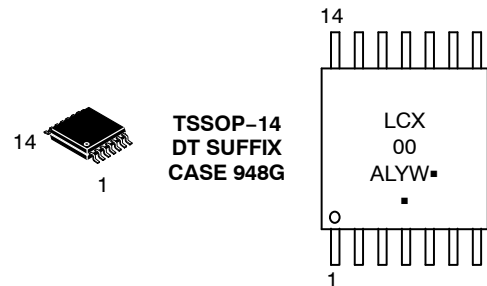
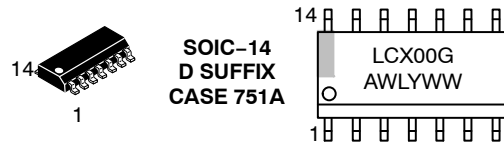

A = Assembly Location
L, WL = Wafer Lot
Y = Year
W, WW = Work Week
G or ■ = Pb-Free Package

(Note: Microdot may be in either location)

ORDERING INFORMATION

See detailed ordering and shipping information in the package dimensions section on page 4 of this data sheet.

MC74LCX00

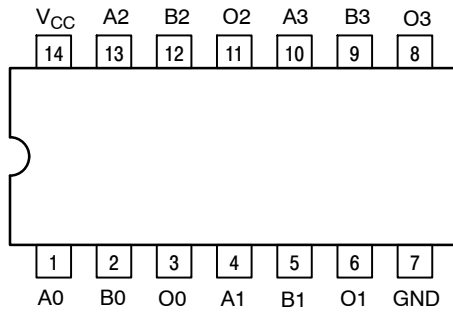

Figure 1. Pinout: 14-lead (Top View)

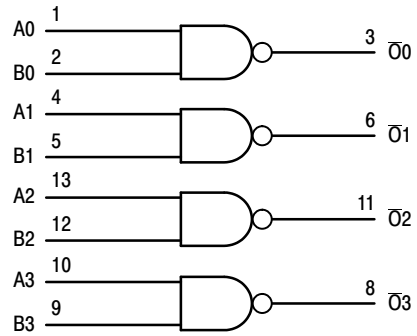

Figure 2. Logic Diagram

PIN NAMES

Pins	Function
An, Bn	Data Inputs
On	Outputs

TRUTH TABLE

Inputs		Outputs
An	Bn	On
L	L	H
L	H	H
H	L	H
H	H	L

H = High Voltage Level
L = Low Voltage Level

For I_{CC} reasons, DO NOT FLOAT Inputs

MAXIMUM RATINGS

Symbol	Parameter	Value	Condition	Unit
V_{CC}	DC Supply Voltage	-0.5 to +7.0		V
V_I	DC Input Voltage	$-0.5 \leq V_I \leq +7.0$		V
V_O	DC Output Voltage	$-0.5 \leq V_O \leq V_{CC} + 0.5$	Output in HIGH or LOW State (Note 1)	V
I_{IK}	DC Input Diode Current	-50	$V_I < GND$	mA
I_{OK}	DC Output Diode Current	-50	$V_O < GND$	mA
		+50	$V_O > V_{CC}$	mA
I_O	DC Output Source/Sink Current	± 50		mA
I_{CC}	DC Supply Current Per Supply Pin	± 100		mA
I_{GND}	DC Ground Current Per Ground Pin	± 100		mA
T_{STG}	Storage Temperature Range	-65 to +150		$^{\circ}C$
MSL	Moisture Sensitivity		Level 1	

Maximum ratings are those values beyond which device damage can occur. Maximum ratings applied to the device are individual stress limit values (not normal operating conditions) and are not valid simultaneously. If these limits are exceeded, device functional operation is not implied, damage may occur and reliability may be affected.

1. I_O absolute maximum rating must be observed.

MC74LCX00

RECOMMENDED OPERATING CONDITIONS

Symbol	Parameter	Min	Type	Max	Unit
V _{CC}	Supply Voltage	Operating	2.5, 3.3	3.6	V
		Data Retention Only	2.5, 3.3	3.6	
V _I	Input Voltage	0		5.5	V
V _O	Output Voltage (HIGH or LOW State) (3-State)	0		V _{CC}	V
I _{OH}	HIGH Level Output Current			-24 -12 -8	mA
I _{OL}	LOW Level Output Current	V _{CC} = 3.0 V – 3.6 V		+24	mA
		V _{CC} = 2.7 V – 3.0 V		+12	
		V _{CC} = 2.3 V – 2.7 V		+8	
T _A	Operating Free-Air Temperature	-40		+85	°C
Δt/ΔV	Input Transition Rise or Fall Rate, V _{IN} from 0.8 V to 2.0 V, V _{CC} = 3.0 V	0		10	ns/V

DC ELECTRICAL CHARACTERISTICS

Symbol	Characteristic	Condition	T _A = -40°C to +85°C		Unit
			Min	Max	
V _{IH}	HIGH Level Input Voltage (Note 2)	2.3 V ≤ V _{CC} ≤ 2.7 V	1.7		V
		2.7 V ≤ V _{CC} ≤ 3.6 V	2.0		
V _{IL}	LOW Level Input Voltage (Note 2)	2.3 V ≤ V _{CC} ≤ 2.7 V		0.7	V
		2.7 V ≤ V _{CC} ≤ 3.6 V		0.8	
V _{OH}	HIGH Level Output Voltage	2.3 V ≤ V _{CC} ≤ 3.6 V; I _{OH} = -100 μA	V _{CC} - 0.2		V
		V _{CC} = 2.3 V; I _{OH} = -8 mA	1.8		
		V _{CC} = 2.7 V; I _{OH} = -12 mA	2.2		
		V _{CC} = 3.0 V; I _{OH} = -18 mA	2.4		
		V _{CC} = 3.0 V; I _{OH} = -24 mA	2.2		
V _{OL}	LOW Level Output Voltage	2.3 V ≤ V _{CC} ≤ 3.6 V; I _{OL} = 100 μA		0.2	V
		V _{CC} = 2.3 V; I _{OL} = 8 mA		0.6	
		V _{CC} = 2.7 V; I _{OL} = 12 mA		0.4	
		V _{CC} = 3.0 V; I _{OL} = 16 mA		0.4	
		V _{CC} = 3.0 V; I _{OL} = 24 mA		0.55	
I _{OFF}	Power Off Leakage Current	V _{CC} = 0, V _{IN} = 5.5 V or V _{OUT} = 5.5 V		10	μA
I _{IN}	Input Leakage Current	V _{CC} = 3.6 V, V _{IN} = 5.5 V or GND		±5	μA
I _{CC}	Quiescent Supply Current	V _{CC} = 3.6 V, V _{IN} = 5.5 V or GND		10	μA
ΔI _{CC}	Increase in I _{CC} per Input	2.3 ≤ V _{CC} ≤ 3.6 V; V _{IH} = V _{CC} - 0.6 V		500	μA

2. These values of V_I are used to test DC electrical characteristics only.

MC74LCX00

AC CHARACTERISTICS ($t_R = t_F = 2.5 \text{ ns}$; $R_L = 500 \Omega$)

Symbol	Parameter	Waveform	Limits						Unit
			$T_A = -40^\circ\text{C to } +85^\circ\text{C}$						
			$V_{CC} = 3.3 \text{ V} \pm 0.3 \text{ V}$		$V_{CC} = 2.7 \text{ V}$		$V_{CC} = 2.5 \text{ V} \pm 0.2 \text{ V}$		
			$C_L = 50 \text{ pF}$		$C_L = 50 \text{ pF}$		$C_L = 30 \text{ pF}$		
			Min	Max	Min	Max	Min	Max	
t_{PLH}	Propagation Delay Time	1	1.5	5.5	1.5	6.2	1.5	6.6	ns
t_{PHL}	Input-to-Output		1.5	5.5	1.5	6.2	1.5	6.6	
t_{OSHL}	Output-to-Output Skew			1.0					ns
t_{OSLH}	(Note 3)			1.0					

3. Skew is defined as the absolute value of the difference between the actual propagation delay for any two separate outputs of the same device. The specification applies to any outputs switching in the same direction, either HIGH-to-LOW (t_{OSHL}) or LOW-to-HIGH (t_{OSLH}); parameter guaranteed by design.

DYNAMIC SWITCHING CHARACTERISTICS

Symbol	Characteristic	Condition	$T_A = +25^\circ\text{C}$			Unit
			Min	Typ	Max	
V_{OLP}	Dynamic LOW Peak Voltage (Note 4)	$V_{CC} = 3.3 \text{ V}$, $C_L = 50 \text{ pF}$, $V_{IH} = 3.3 \text{ V}$, $V_{IL} = 0 \text{ V}$ $V_{CC} = 2.5 \text{ V}$, $C_L = 30 \text{ pF}$, $V_{IH} = 2.5 \text{ V}$, $V_{IL} = 0 \text{ V}$		0.8 0.6		V V
V_{OLV}	Dynamic LOW Valley Voltage (Note 4)	$V_{CC} = 3.3 \text{ V}$, $C_L = 50 \text{ pF}$, $V_{IH} = 3.3 \text{ V}$, $V_{IL} = 0 \text{ V}$ $V_{CC} = 2.5 \text{ V}$, $C_L = 30 \text{ pF}$, $V_{IH} = 2.5 \text{ V}$, $V_{IL} = 0 \text{ V}$		-0.8 -0.6		V V

4. Number of outputs defined as "n". Measured with "n-1" outputs switching from HIGH-to-LOW or LOW-to-HIGH. The remaining output is measured in the LOW state.

CAPACITIVE CHARACTERISTICS

Symbol	Parameter	Condition	Typical	Unit
C_{IN}	Input Capacitance	$V_{CC} = 3.3 \text{ V}$, $V_I = 0 \text{ V}$ or V_{CC}	7	pF
C_{OUT}	Output Capacitance	$V_{CC} = 3.3 \text{ V}$, $V_I = 0 \text{ V}$ or V_{CC}	8	pF
C_{PD}	Power Dissipation Capacitance	10 MHz, $V_{CC} = 3.3 \text{ V}$, $V_I = 0 \text{ V}$ or V_{CC}	25	pF

ORDERING INFORMATION

Device	Package	Shipping [†]
MC74LCX00DG	SOIC-14 (Pb-Free)	55 Units / Rail
MC74LCX00DR2G	SOIC-14 (Pb-Free)	2500 Tape & Reel
MC74LCX00DTG	TSSOP-14 (Pb-Free)	96 Units / Rail
MC74LCX00DTR2G	TSSOP-14 (Pb-Free)	2500 Tape & Reel
NLV74LCX00DTR2G*	TSSOP-14 (Pb-Free)	2500 Tape & Reel

[†]For information on tape and reel specifications, including part orientation and tape sizes, please refer to our Tape and Reel Packaging Specifications Brochure, BRD8011/D.

*NLV Prefix for Automotive and Other Applications Requiring Unique Site and Control Change Requirements; AEC-Q100 Qualified and PPAP Capable.

MC74LCX00

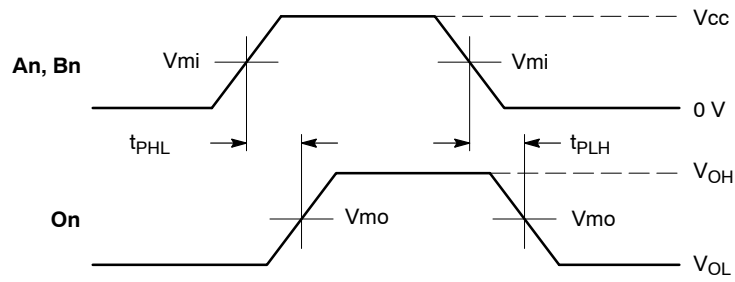

WAVEFORM 1 - PROPAGATION DELAYS

$t_R = t_F = 2.5 \text{ ns}$, 10% to 90%; $f = 1 \text{ MHz}$; $t_W = 500 \text{ ns}$

Symbol	Vcc		
	3.3 V ± 0.3 V	2.7 V	2.5 V ± 0.2 V
Vmi	1.5 V	1.5 V	Vcc/2
Vmo	1.5 V	1.5 V	Vcc/2

Figure 3. AC Waveforms

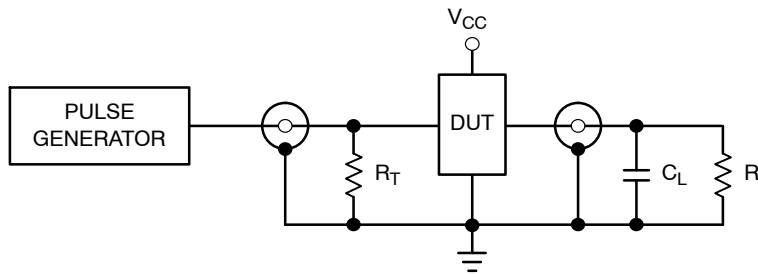

$C_L = 50 \text{ pF}$ at $V_{CC} = 3.3 \pm 0.3 \text{ V}$ or equivalent (includes jig and probe capacitance)
 $C_L = 30 \text{ pF}$ at $V_{CC} = 2.5 \pm 0.2 \text{ V}$ or equivalent (includes jig and probe capacitance)
 $R_L = R_1 = 500 \Omega$ or equivalent
 $R_T = Z_{OUT}$ of pulse generator (typically 50Ω)

Figure 4. Test Circuit

MC74LCX00

PACKAGE DIMENSIONS

TSSOP-14
CASE 948G
ISSUE B

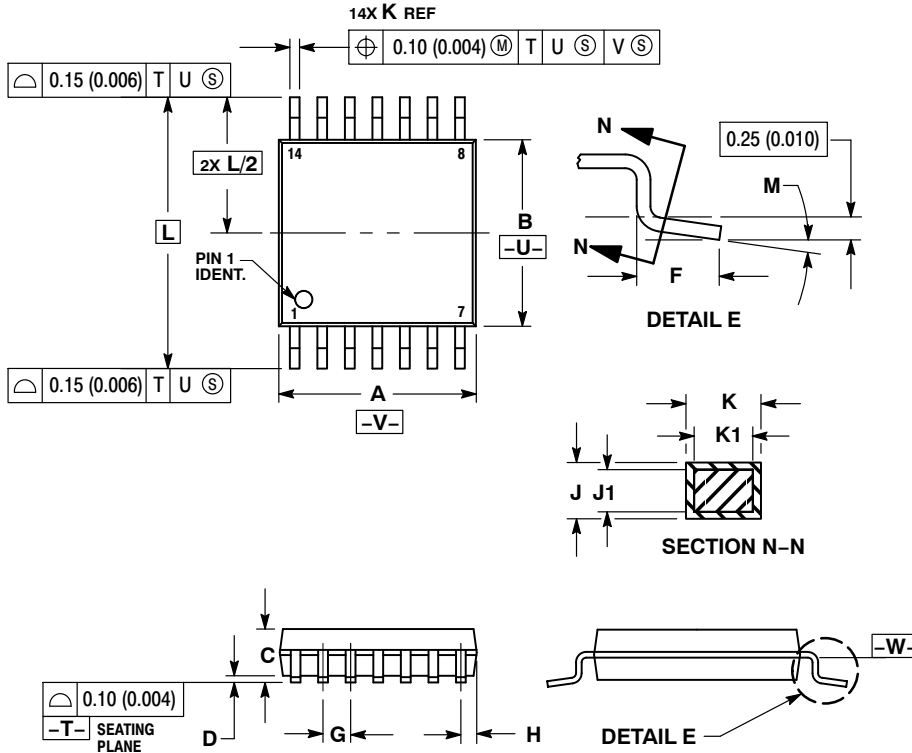

NOTES:

1. DIMENSIONING AND TOLERANCING PER ANSI Y14.5M, 1982.
2. CONTROLLING DIMENSION: MILLIMETER.
3. DIMENSION A DOES NOT INCLUDE MOLD FLASH, PROTRUSIONS OR GATE BURRS. MOLD FLASH OR GATE BURRS SHALL NOT EXCEED 0.15 (0.006) PER SIDE.
4. DIMENSION B DOES NOT INCLUDE INTERLEAD FLASH OR PROTRUSION. INTERLEAD FLASH OR PROTRUSION SHALL NOT EXCEED 0.25 (0.010) PER SIDE.
5. DIMENSION K DOES NOT INCLUDE DAMBAR PROTRUSION. ALLOWABLE DAMBAR PROTRUSION SHALL BE 0.08 (0.003) TOTAL IN EXCESS OF THE K DIMENSION AT MAXIMUM MATERIAL CONDITION.
6. TERMINAL NUMBERS ARE SHOWN FOR REFERENCE ONLY.
7. DIMENSION A AND B ARE TO BE DETERMINED AT DATUM PLANE -W-.

DIM	MILLIMETERS		INCHES	
	MIN	MAX	MIN	MAX
A	4.90	5.10	0.193	0.200
B	4.30	4.50	0.169	0.177
C	---	1.20	---	0.047
D	0.05	0.15	0.002	0.006
F	0.50	0.75	0.020	0.030
G	0.65 BSC		0.026 BSC	
H	0.50	0.60	0.020	0.024
J	0.09	0.20	0.004	0.008
J1	0.09	0.16	0.004	0.006
K	0.19	0.30	0.007	0.012
K1	0.19	0.25	0.007	0.010
L	6.40 BSC		0.252 BSC	
M	0°	8°	0°	8°

SOLDERING FOOTPRINT*

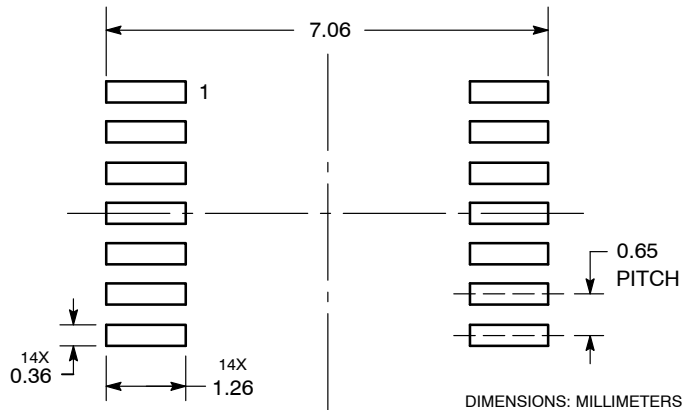

*For additional information on our Pb-Free strategy and soldering details, please download the ON Semiconductor Soldering and Mounting Techniques Reference Manual, SOLDERRM/D.

MC74LCX00

PACKAGE DIMENSIONS

SOIC-14 NB
CASE 751A-03
ISSUE K

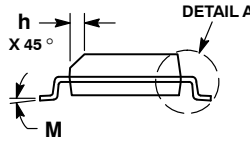
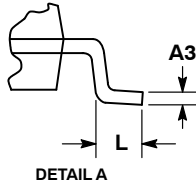
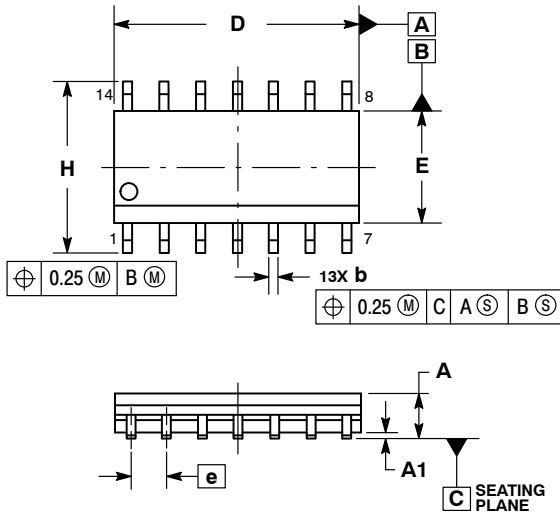

- NOTES:
1. DIMENSIONING AND TOLERANCING PER ASME Y14.5M, 1994.
 2. CONTROLLING DIMENSION: MILLIMETERS.
 3. DIMENSION b DOES NOT INCLUDE DAMBAR PROTRUSION. ALLOWABLE PROTRUSION SHALL BE 0.13 TOTAL IN EXCESS OF AT MAXIMUM MATERIAL CONDITION.
 4. DIMENSIONS D AND E DO NOT INCLUDE MOLD PROTRUSIONS.
 5. MAXIMUM MOLD PROTRUSION 0.15 PER SIDE.

DIM	MILLIMETERS		INCHES	
	MIN	MAX	MIN	MAX
A	1.35	1.75	0.054	0.068
A1	0.10	0.25	0.004	0.010
A3	0.19	0.25	0.008	0.010
b	0.35	0.49	0.014	0.019
D	8.55	8.75	0.337	0.344
E	3.80	4.00	0.150	0.157
e	1.27 BSC		0.050 BSC	
H	5.80	6.20	0.228	0.244
h	0.25	0.50	0.010	0.019
L	0.40	1.25	0.016	0.049
M	0°	7°	0°	7°

SOLDERING FOOTPRINT*

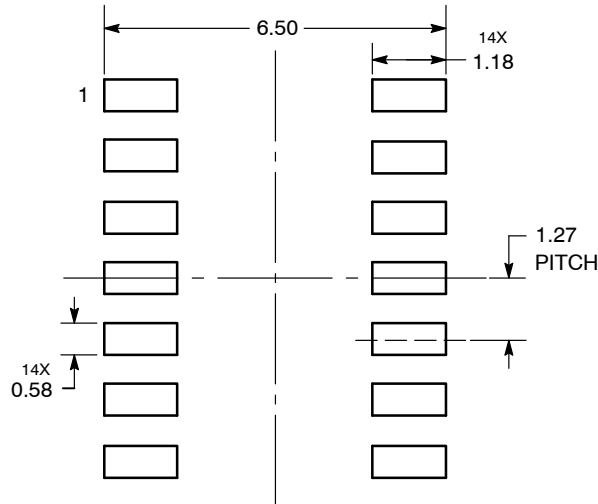

DIMENSIONS: MILLIMETERS

*For additional information on our Pb-Free strategy and soldering details, please download the ON Semiconductor Soldering and Mounting Techniques Reference Manual, SOLDERRM/D.

ON Semiconductor and are registered trademarks of Semiconductor Components Industries, LLC (SCILLC). SCILLC owns the rights to a number of patents, trademarks, copyrights, trade secrets, and other intellectual property. A listing of SCILLC's product/patent coverage may be accessed at www.onsemi.com/site/pdf/Patent-Marking.pdf. SCILLC reserves the right to make changes without further notice to any products herein. SCILLC makes no warranty, representation or guarantee regarding the suitability of its products for any particular purpose, nor does SCILLC assume any liability arising out of the application or use of any product or circuit, and specifically disclaims any and all liability, including without limitation special, consequential or incidental damages. "Typical" parameters which may be provided in SCILLC data sheets and/or specifications can and do vary in different applications and actual performance may vary over time. All operating parameters, including "Typicals" must be validated for each customer application by customer's technical experts. SCILLC does not convey any license under its patent rights nor the rights of others. SCILLC products are not designed, intended, or authorized for use as components in systems intended for surgical implant into the body, or other applications intended to support or sustain life, or for any other application in which the failure of the SCILLC product could create a situation where personal injury or death may occur. Should Buyer purchase or use SCILLC products for any such unintended or unauthorized application, Buyer shall indemnify and hold SCILLC and its officers, employees, subsidiaries, affiliates, and distributors harmless against all claims, costs, damages, and expenses, and reasonable attorney fees arising out of, directly or indirectly, any claim of personal injury or death associated with such unintended or unauthorized use, even if such claim alleges that SCILLC was negligent regarding the design or manufacture of the part. SCILLC is an Equal Opportunity/Affirmative Action Employer. This literature is subject to all applicable copyright laws and is not for resale in any manner.

PUBLICATION ORDERING INFORMATION

LITERATURE FULFILLMENT:
Literature Distribution Center for ON Semiconductor
P.O. Box 5163, Denver, Colorado 80217 USA
Phone: 303-675-2175 or 800-344-3860 Toll Free USA/Canada
Fax: 303-675-2176 or 800-344-3867 Toll Free USA/Canada
Email: orderlit@onsemi.com

N. American Technical Support: 800-282-9855 Toll Free
USA/Canada
Europe, Middle East and Africa Technical Support:
Phone: 421 33 790 2910
Japan Customer Focus Center
Phone: 81-3-5817-1050

ON Semiconductor Website: www.onsemi.com
Order Literature: <http://www.onsemi.com/orderlit>
For additional information, please contact your local Sales Representative

Mouser Electronics

Authorized Distributor

Click to View Pricing, Inventory, Delivery & Lifecycle Information:

[ON Semiconductor:](#)

[MC74LCX00DG](#) [MC74LCX00DR2G](#) [MC74LCX00DTG](#) [MC74LCX00DTR2G](#)