

LTM4645 High Efficiency, PolyPhase 50A Step-Down Power μ Module Regulator

DESCRIPTION

Demonstration circuit 2616A-A features a polyphase design using the [LTM®4645EY](#), a 25A high efficiency, switch mode step-down power μ Module regulator. The input voltage range is from 6V to 15V. To use DC2616A-A for input voltage range from 4.7V to 6V, connect INTV_{CC} to SV_{IN} (change R22, R42 from OPT to 0 Ω), DRV_{CC} to V_{IN} (change R21, R38 from 0 Ω to OPT, R2, R39 from OPT to 0 Ω). The output voltage range is 0.6V to 1.8V. The DC2616A-A can deliver a nominal 50A output current. As explained in the data sheet, output current derating is necessary for certain V_{IN}, V_{OUT}, and thermal conditions. The board operates in continuous conduction mode in heavy load conditions. For high efficiency at low load currents, the MODE_PLLIN jumper selects pulse-skipping mode for

noise sensitive applications or burst mode operation in less noise sensitive applications. The MODE_PLLIN pin also allows the LTM4645 to synchronize to an external clock signal. The phase shift between the two phases is 180 degrees. DC2616A-A has the option of choosing both internal and external compensation circuit for LTM4645. The LTM4645 data sheet must be read in conjunction with this demo manual prior to working on or modifying demo circuit DC2616A-A.

Design files for this circuit board are available at <http://www.linear.com/demo/DC2616A-A>

All registered trademarks and trademarks are the property of their respective owners.

BOARD PHOTO

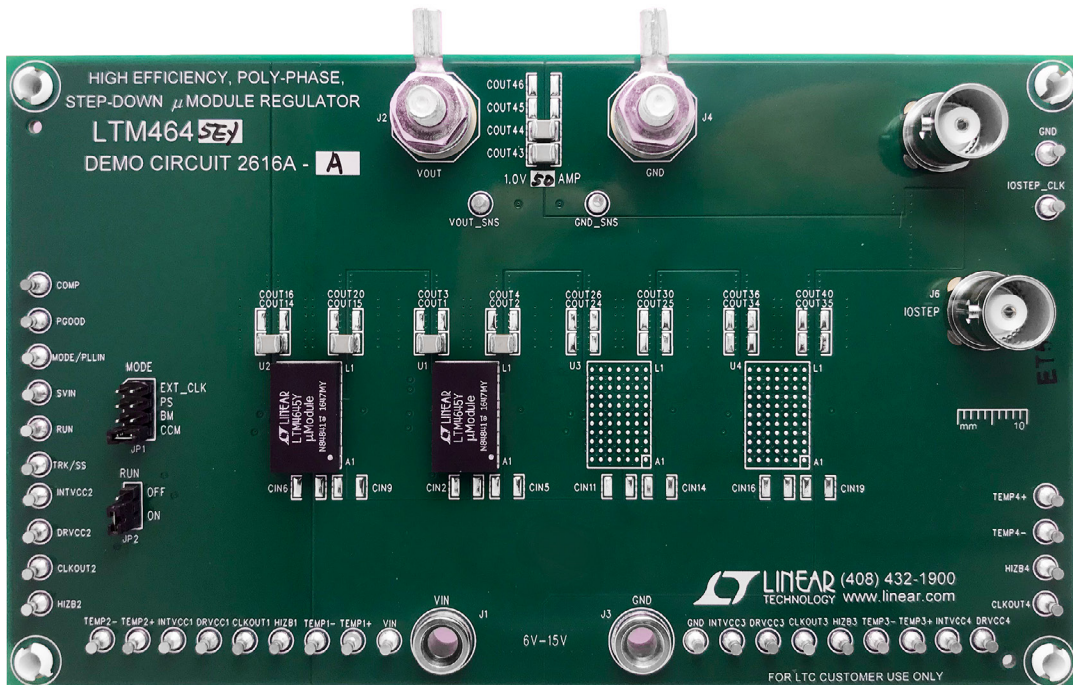

PERFORMANCE SUMMARY Specifications are at T_A = 25°C

PARAMETER	CONDITIONS	VALUE
Input Voltage Range		6V to 15V
Output Voltages		1.0V ± 1.2%
Maximum Continuous Output Current	De-rating is Necessary for Certain Operating Conditions. See Data Sheet for Details.	50ADC
Operating Frequency		600kHz
Efficiency	V _{IN} = 12V, V _{OUT} = 1.0V, I _{OUT} = 50A	84.4% Figure 2
Load Transient	V _{IN} = 12V, V _{OUT} = 1.0V, I _{STEP} = 0A to 12.5A	53.8mV Figure 3

QUICK START PROCEDURE

Demonstration circuit DC2616A-A is an easy way to evaluate the performance of polyphase operation of the LTM4645EY. Due to the high input/output current, the user should select the proper input supply/load/cable which can sustain the full load operation. Please refer to Figure 1 for proper measurement equipment setup and follow the procedure below:

- Place jumpers in the following positions for a typical application:

MODE	RUN
CCM	ON

- With power off, connect the input power supply, load and meters as shown in Figure 1. Preset the load to 0A and V_{IN} supply to 12V.
- Turn on the power supply at the input. The output voltage should be 1.0V ± 1.2% (0.988V to 1.012V).

- Vary the input voltage from 6V to 15V and adjust the load current from 0A to 50A. Observe the output voltage regulation, ripple voltage, efficiency, and other parameters.
- (Optional) For optional load transient test, apply an adjustable pulse signal between IOSTEP_CLK and GND test points. The pulse amplitude sets the load step current amplitude. Keep the pulse width short (<1ms) and pulse duty cycle low (<5%) to limit the thermal stress on the load transient circuit.
- (Optional) LTM4645 can be synchronized to an external clock signal. Apply a clock signal (0V to 5V, square wave) on the MODE_PLLIN test point.
- (Optional) The outputs of LTM4645 can track another supply. The output voltage tracks the voltage on TRACK when a valid signal is applied on the test point.

QUICK START PROCEDURE

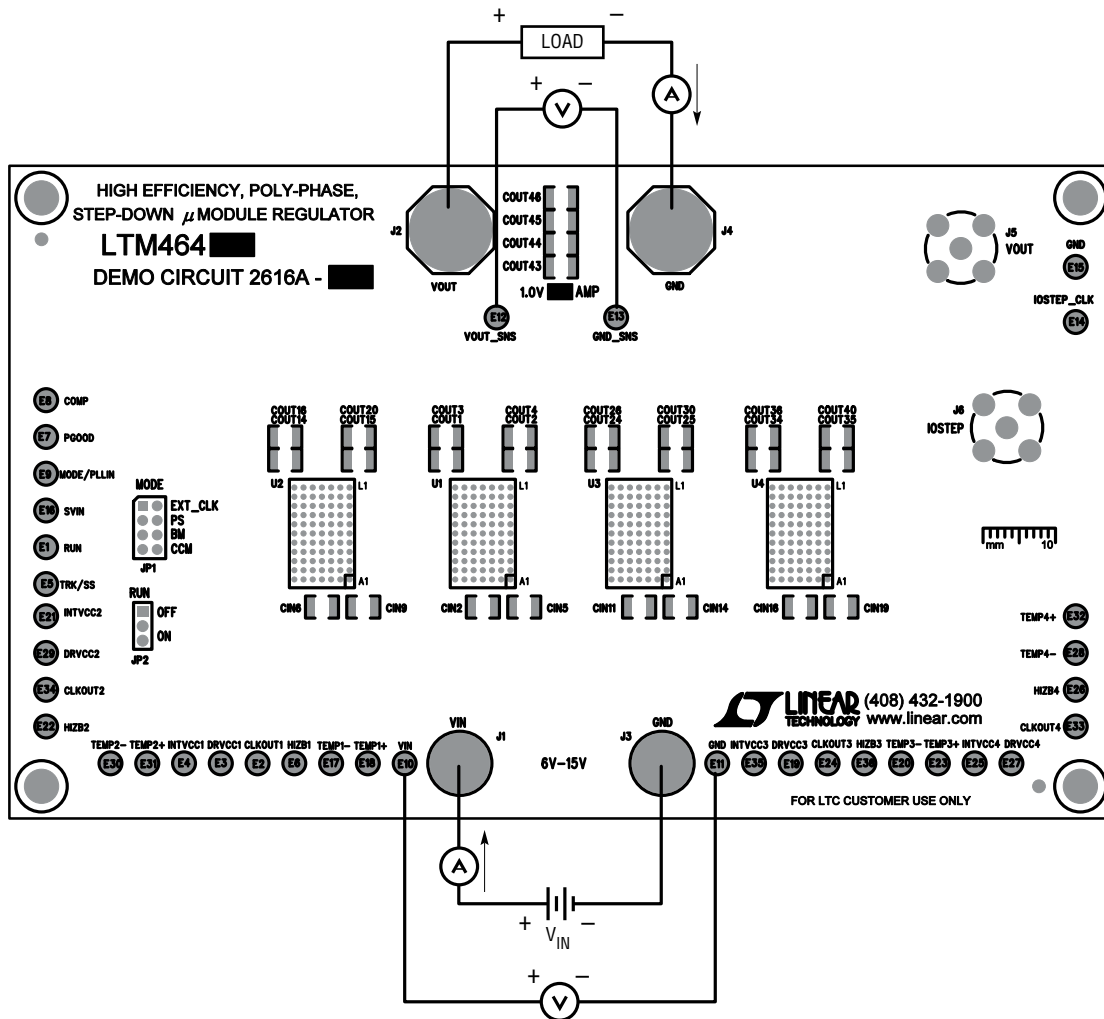

Figure 1. Measurement Setup of DC2616A-A

QUICK START PROCEDURE

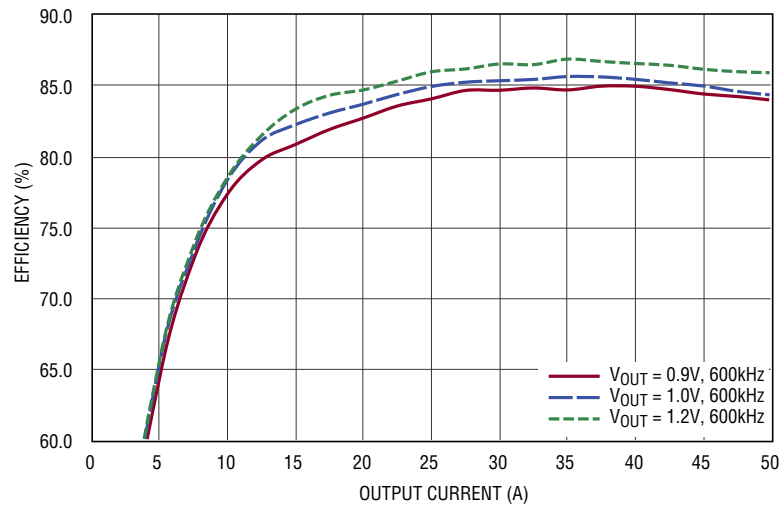

Figure 2. Measured Efficiency at V_{IN} = 12V, f_{SW} = 600kHz, CCM

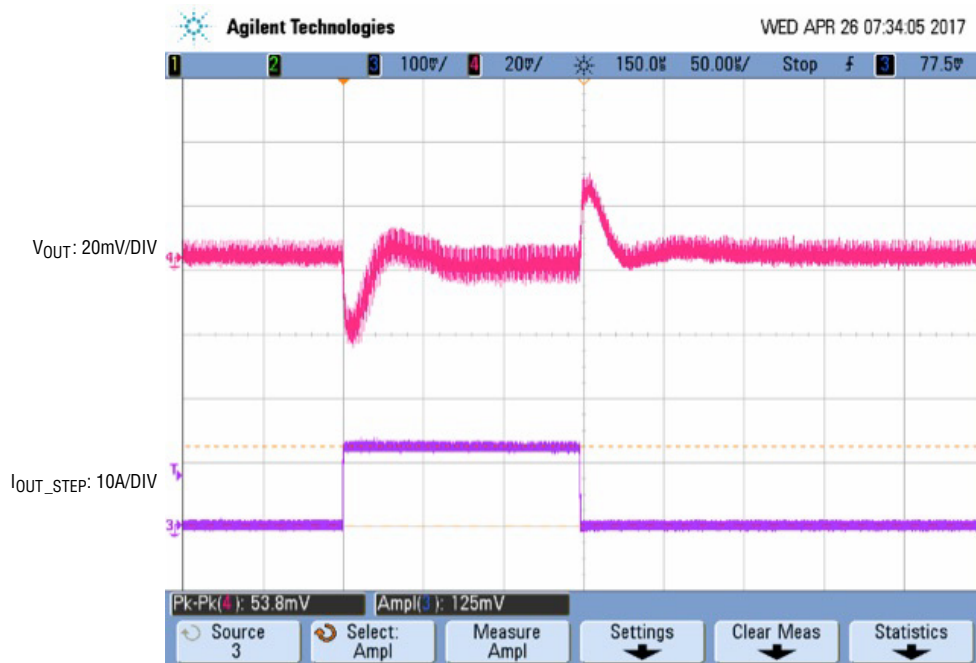

Figure 3. Measured Load Transient
V_{IN} = 12V, V_{OUT} = 1.0V, I_{STEP} = 0A to 12.5A

QUICK START PROCEDURE

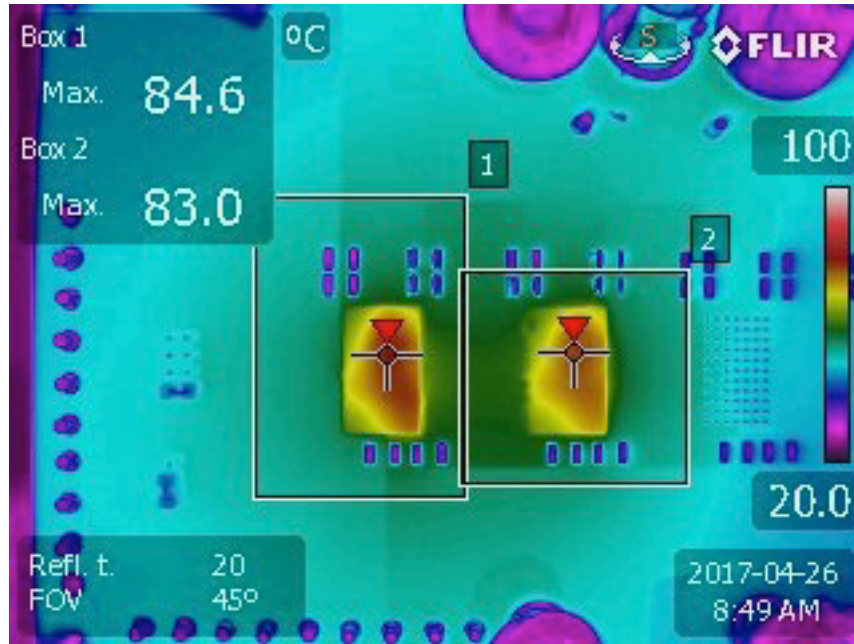

Figure 4. Thermal Capture at 12V_{IN}, 1.0V_{OUT}, 50A (T_A = 25°C, No Airflow)

DEMO MANUAL DC2616A-A

PARTS LIST

ITEM	QTY	REFERENCE	PART DESCRIPTION	MANUFACTURER/PART NUMBER
Required Circuit Components				
1	2	C1, C12	CAP, 1 μ F, X7R, 50V, 10%, 0603	TAIYO YUDEN, UMK107AB7105KA-T
2	8	COUT1, COUT2, COUT5, COUT14, COUT15, COUT21, COUT43, COUT44	CAP, 100 μ F, X5R, 6.3V, 20%, 1210	MURATA, GRM32ER60J107ME20L
3	1	CIN1	CAP, 150 μ F, ALUM., 35V, 20%, 10mm \times 10.5mm, SMD, HVH Series	SUN ELECTRONIC INDUSTRIES CORP, 35HVH150M
4	2	C2, C11	CAP, 4.7 μ F, X5R, 10V, 10%, 0603	AVX, 0603ZD475KAT2A TAIYO YUDEN, LMK107BJ475KA-T TDK, C1608X5R1A475K080AC
5	1	C3	CAP, 0.1 μ F, X7R, 16V, 10%, 0603	AVX, 0603YC104KAT2A NIC, NMC0603X7R104K16TRPF
6	4	CIN3, CIN4, CIN7, CIN8	CAP, 22 μ F, X5R, 25V, 20%, 1210	AVX, 12103D226MAT2A MURATA, GRM32ER61E226ME15L
7	1	C5	CAP, 120pF, X7R, 50V, 10%, 0603	YAGEO, CC0603KRX7R9BB121
8	4	COUT7, COUT8, COUT13, COUT19	CAP, 330 μ F, TANT, 2V, 20%, 7343, D2E	PANASONIC, 2TPF330M6
9	1	C8	CAP, 1 μ F, X7R, 50V, 10%, 0805	MURATA, GRM21BR71H105KA12L TAIYO YUDEN, UMK212B7105KG-T YAGEO, CC0805KXX7R9BB105
10	3	R3, R19, R46	RES., 10k Ω , 1%, 1/10W, 0603, AEC-Q200	KOA SPEER, RK73H1JTTD1002F PANASONIC, ERJ3EKF1002V VISHAY, CRCW060310K0FKEA
11	1	R4	RES., 100k Ω , 1%, 1/10W, 0603	NIC, NRC06F1003TRF PANASONIC, ERJ3EKF1003V VISHAY, CRCW0603100KFKEA
12	2	R7, R26	RES., 49.9k Ω , 1%, 1/10W, 0603	VISHAY, CRCW060349K9FKEA YAGEO, RC0603FR-0749K9L
13	2	R9, R44	RES., 47.5k Ω , 1%, 1/10W, 0603	VISHAY, CRCW060347K5FKEA YAGEO, RC0603FR-0747K5L
14	2	R14, R16	RES., 10 Ω , 5%, 1/10W, 0603	NIC, NRC06J100TRF VISHAY, CRCW060310R0JNEA
15	1	R15	RES., 90.9k Ω , 1%, 1/10W, 0603, AEC-Q200	KOA SPEER, RK73H1JTTD9092F PANASONIC, ERJ3EKF9092V VISHAY, CRCW060390K9FKEA
16	1	R20	RES., 0.01 Ω , 1%, 1/2W, 2010, SENSE, AEC-Q200	VISHAY, WSL2010R0100FEA
17	1	R24	RES., 2.2 Ω , 5%, 1/10W, 0603, AEC-Q200	VISHAY, CRCW06032R20JNEA
18	2	U1, U2	IC, Single 25A DC/DC μ Module Reg., BGA- 77 (15mm \times 9mm \times 3.51mm)	LINEAR TECH., LTM4645EY#PBF

PARTS LIST

ITEM	QTY	REFERENCE	PART DESCRIPTION	MANUFACTURER/PART NUMBER
Additional Demo Board Circuit Components				
1	1	Q1	XSTR., MOSFET, N-CH, 40V, TO-252 (DPAK)	VISHAY, SUD50N04-8M8P-4GE3
2	13	R1, R5, R6, R12, R13, R18, R21, R27, R28, R36, R38, R43, R45	RES., 0Ω, 1/10W, 0603	NIC, NRC06ZOTRF VISHAY, CRCW06030000Z0EA
3	0	U3, U4 (OPT)	IC., OPTION, BGA-77	
4	0	R2, R8, R10, R11, R12, R17, R22, R23, R39, R41, R42, R43, R48, R49, R50, R51, R52, R53, R54, R55, R56, R57, R58, R59, R61, R62, R63, R64, R65, R66, R67, R68, R69, R70, R71, R72 (OPT)	RES., OPTION, 0603	
5	0	COU11, COU12, COU17, COU18, COU27, COU28, COU37, COU38 (OPT)	CAP, OPTION, D3L	
6	0	C4, C6, C7, C9, C17, C18, C19, C21, C22, C20, C23, C24, C25, C26 (OPT)	CAP, OPTION, 0603	
7	0	CIN2, CIN5, CIN6, CIN9, CIN11, CIN12, CIN13, CIN14, CIN16, CIN17, CIN18, CIN19, COU3, COU4, COU6, COU9, COU10, COU16, COU20, COU22, COU24, COU25, COU26, COU30, COU31, COU32, COU34, COU35, COU36, COU40, COU41, COU42, COU45, COU46 (OPT)	CAP, OPTION, 1210	
8	0	COU23, COU29, COU33, COU39 (OPT)	CAP, OPTION, D2E	
Hardware: For Demo Board Only				
1	36	E1, E2, E3, E4, E5, E6, E7, E8, E9, E10, E11, E12, E13, E14, E15, E16, E17, E18, E19, E20, E21, E22, E23, E24, E25, E26, E27, E28, E29, E30, E31, E32, E33, E34, E35, E36	TEST POINT, TURRET, 0.064", MTG. HOLE	MILL-MAX, 2308-2-00-80-00-00-07-0
2	1	JP1	CONN., HDR, MALE, 2x4, 2mm, THT STR	SULLINS CONNECTOR SOLUTIONS, NRPNO42PAEN-RC
3	2	J1, J3	CONN., BANANA JACK, FEMALE, THT, NON-INSULATED, SWAGE	KEYSTONE, 575-4
4	2	J2, J4	WASHER, FLAT, STEEL, ZINC PLATE, OD: 0.436 [11.1]	KEYSTONE, 4703
5	2	J2, J4	STUD, FASTENER, #10-32	PENNINGENGINEERING, KFH-032-10
6	4	J2, J4	NUT, HEX, STEEL, ZINC PLATE, 10-32	KEYSTONE, 4705
7	2	J2, J4	RING, LUG, CRIMP, #10, NON-INSULATED, SOLDERLESS TERMINALS	KEYSTONE, 8205
8	1	JP2	CONN., HDR., MALE, 1x3, 2mm, THT, STR	SULLINS CONNECTOR SOLUTIONS, NRPNO31PAEN-RC
9	2	J5, J6	CONN., RF, BNC, RCPT, THT, STR, 5-PIN	AMPHENOL CONNEX, 112404
10	4	MH1, MH2, MH3, MH4	STANDOFF, NYLON, SNAP-ON, 0.50"	KEYSTONE, 8833
11	2	XJP1, XJP2	CONN., SHUNT, FEMALE, 2 POS, 2mm	SAMTEC, 2SN-BK-G

DEMO MANUAL DC2616A-A

SCHEMATIC DIAGRAM

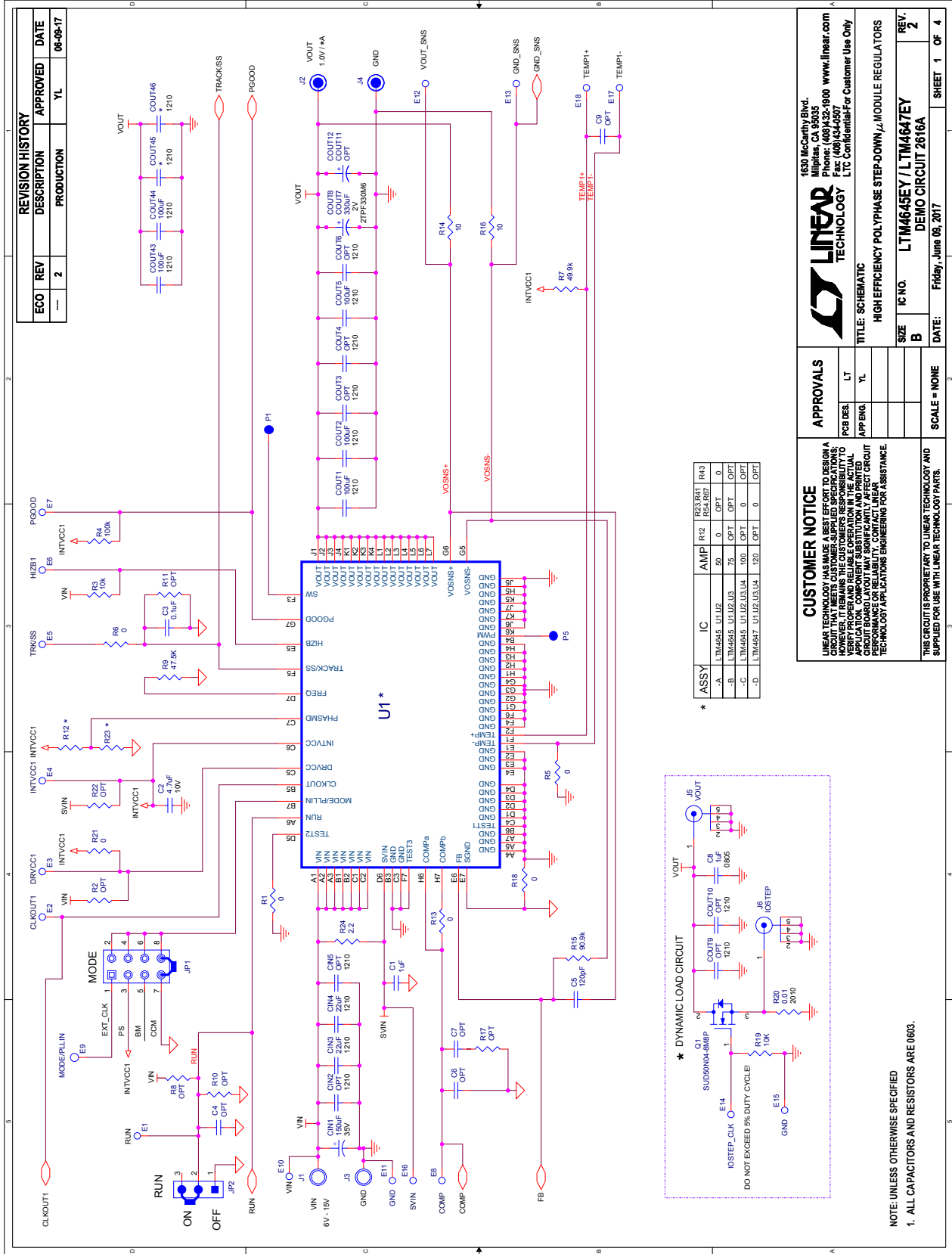

SCHEMATIC DIAGRAM

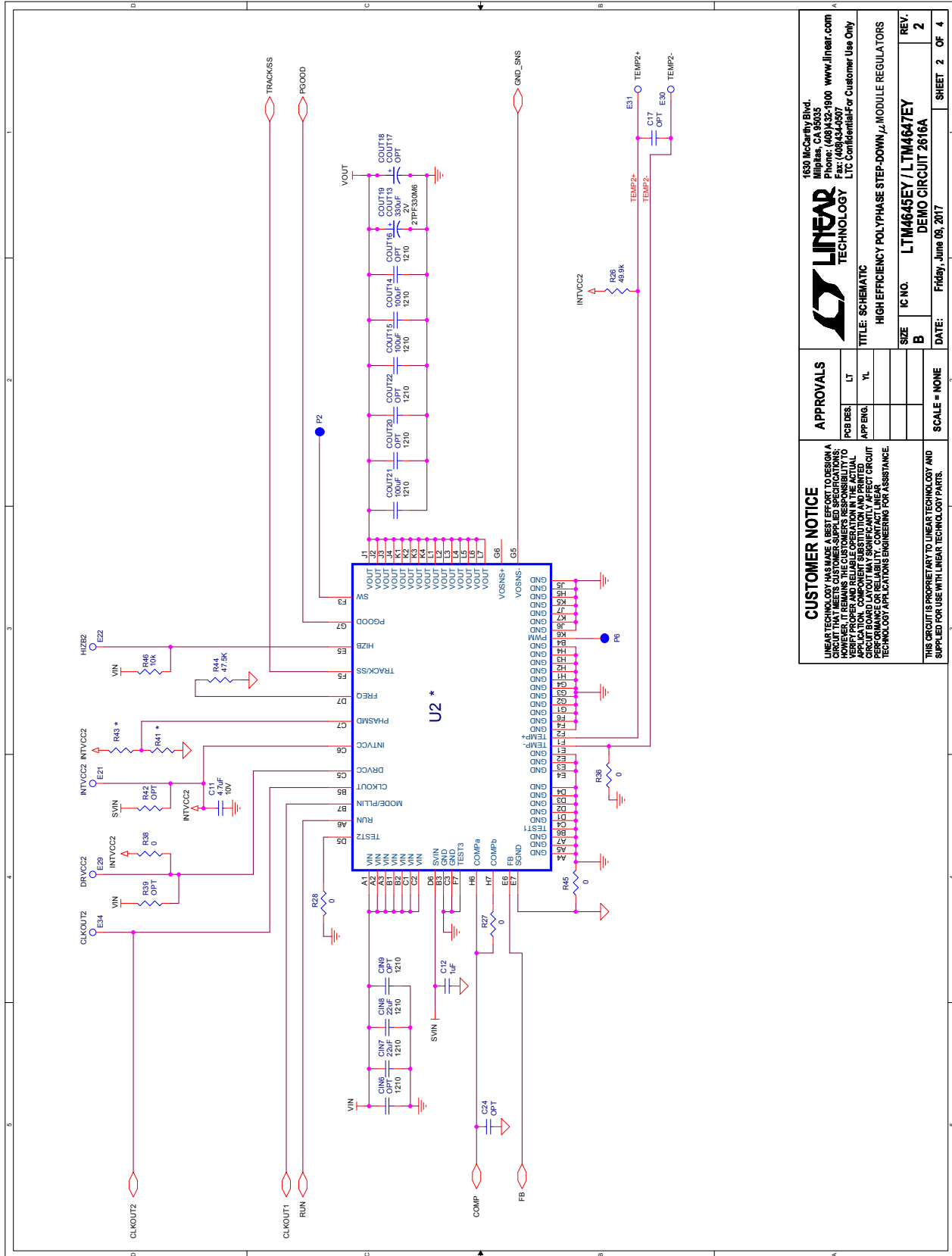

CUSTOMER NOTICE
 LINEAR TECHNOLOGY HAS MADE A BEST EFFORT TO DESIGN A CIRCUIT THAT MEETS CUSTOMER-SPECIFIED REQUIREMENTS. CUSTOMERS ARE RESPONSIBLE FOR VERIFYING THE ACTUAL PERFORMANCE OF THE CIRCUIT IN THEIR APPLICATION. VERIFY PROPER AND RELIABLE OPERATION IN THE ACTUAL APPLICATION. COMPONENT SUBSTITUTION AND PRINTED CIRCUIT BOARD MANUFACTURING VARIATIONS MAY AFFECT PERFORMANCE OR RELIABILITY. CONTACT LINEAR TECHNOLOGY APPLICATIONS ENGINEERING FOR ASSISTANCE.

APPROVALS

DESIGN	LT
APPNG.	YL

SCALE = NONE

SIZE	IC NO.	LTM4645EY / LTM4647EY	REV.
B		DEMO CIRCUIT 2616A	2
	DATE:	Friday, June 09, 2017	SHEET 2 OF 4

LINEAR TECHNOLOGY
 1630 McCarthy Blvd.
 Milpitas, CA 95035
 Phone: (408) 432-1900 www.linear.com
 Fax: (408) 434-0077
 LTC Confidential For Customer Use Only

TITLE: SCHEMATIC
 HIGH EFFICIENCY POLYPHASE STEP-DOWN μ MODULE REGULATORS

DEMO MANUAL DC2616A-A

SCHEMATIC DIAGRAM

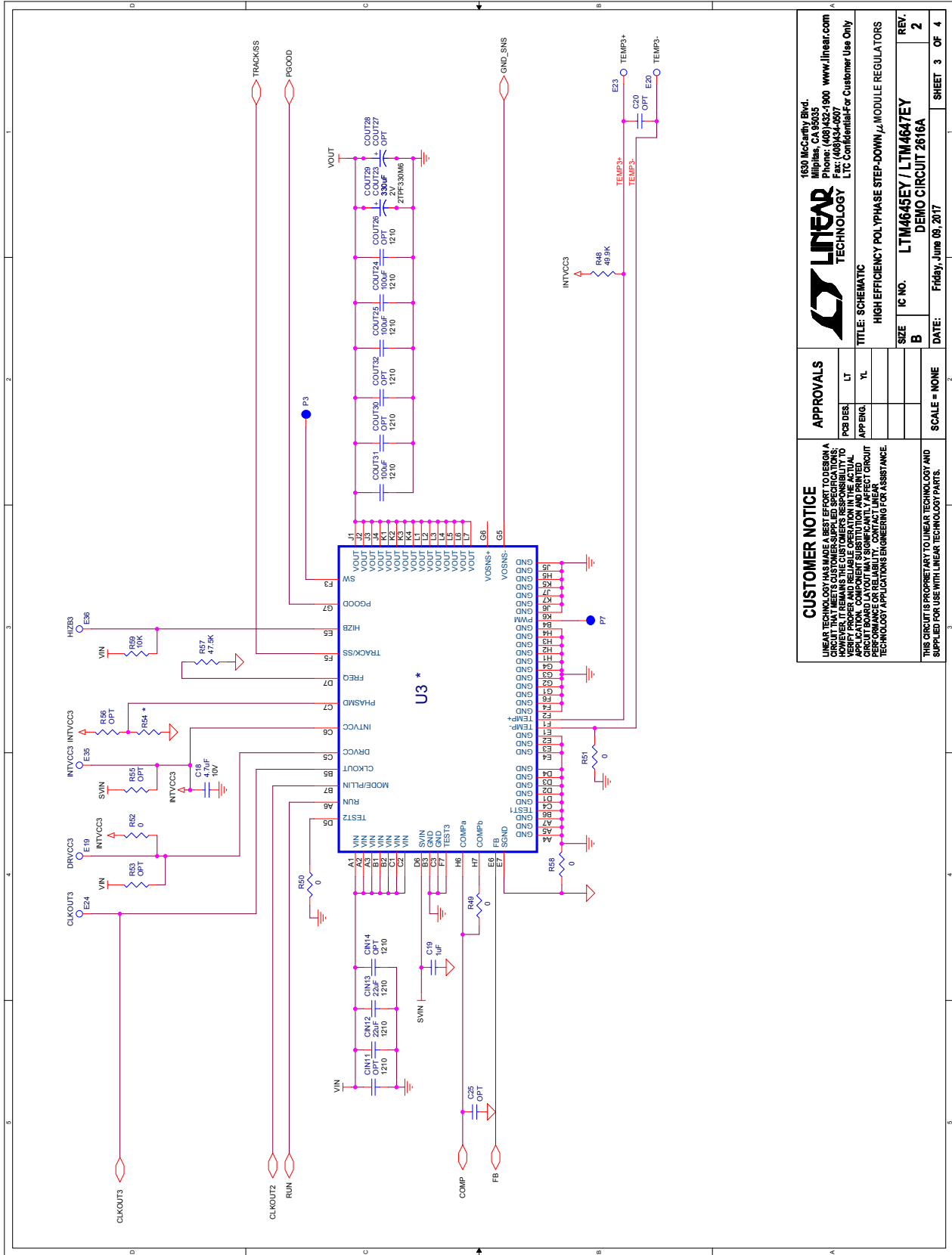

<p>CUSTOMER NOTICE LINEAR TECHNOLOGY HAS MADE A BEST EFFORT TO DESIGN A CIRCUIT THAT MEETS CUSTOMER SPECIFIED REQUIREMENTS. CUSTOMER AGREES TO HOLD LINEAR TECHNOLOGY HARMLESS FROM ANY LIABILITY ARISING FROM THE ACTUAL APPLICATION COMPONENT SUBSTITUTION AND PRINTED BOARD MANUFACTURING VARIATIONS. CUSTOMER AGREES TO HOLD LINEAR TECHNOLOGY HARMLESS FROM ANY LIABILITY ARISING FROM PERFORMANCE OR RELIABILITY. CONTACT LINEAR TECHNOLOGY APPLICATIONS ENGINEERING FOR ASSISTANCE.</p>		<p>APPROVALS</p> <table border="1"> <tr> <td>PB DES.</td> <td>LT</td> </tr> <tr> <td>APPNG.</td> <td>YL</td> </tr> </table>		PB DES.	LT	APPNG.	YL
PB DES.	LT						
APPNG.	YL						
<p>LINEAR TECHNOLOGY 1630 McCarthy Blvd. Milpitas, CA 95035 Phone: (408) 432-1900 www.linear.com Fax: (408) 434-6097 LTC Confidential For Customer Use Only</p>		<p>TITLE: SCHEMATIC HIGH EFFICIENCY POL. PHASE STEP-DOWN μMODULE REGULATORS</p>					
SIZE	IC NO.	LTM4645EY / LTM4647EY	REV.				
B		DEMO CIRCUIT 2616A	2				
DATE:		Friday, June 09, 2017	SHEET 3 OF 4				

SCHEMATIC DIAGRAM

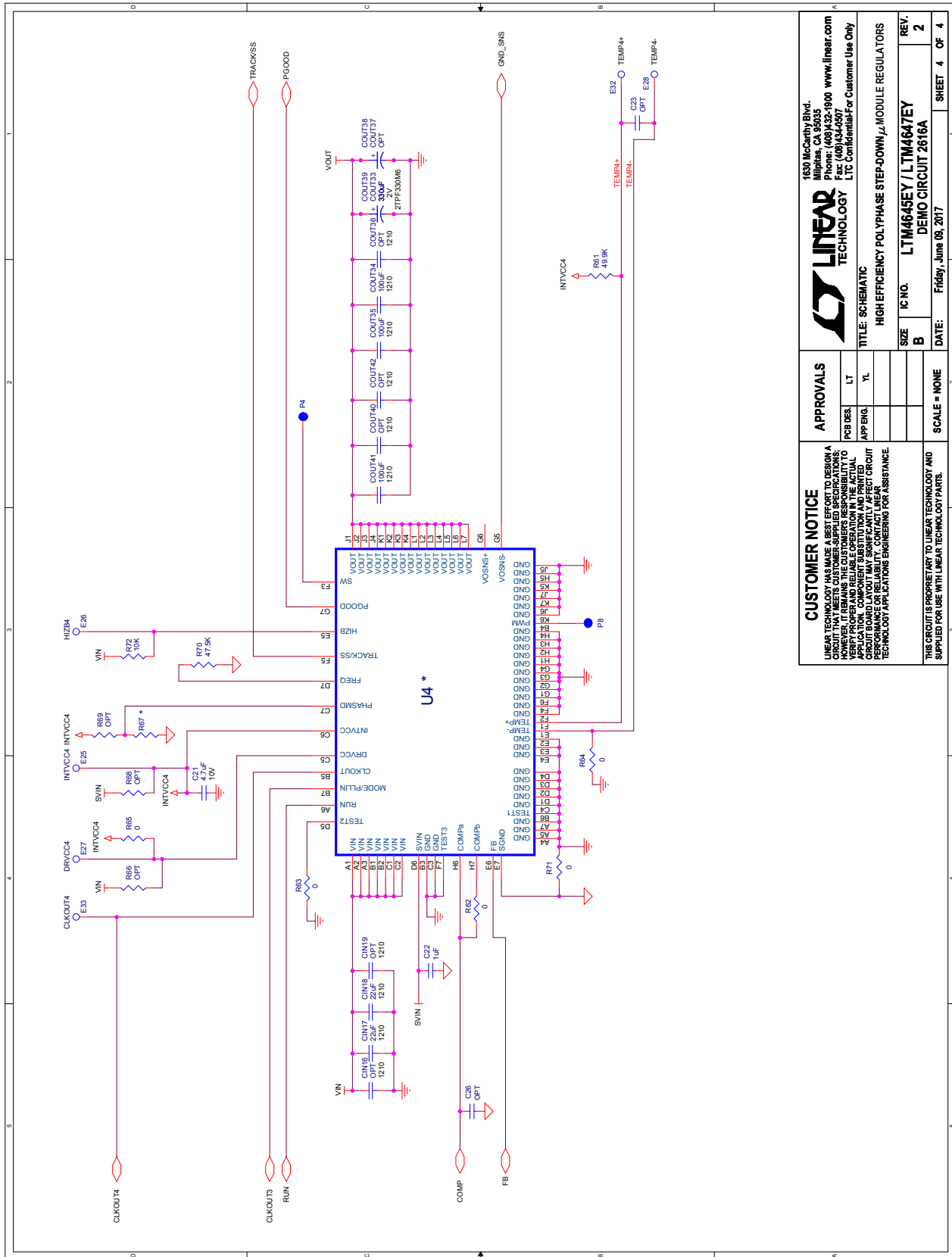

CUSTOMER NOTICE

LINEAR TECHNOLOGY HAS MADE A BEST EFFORT TO DESIGN A CIRCUIT THAT MEETS CUSTOMER-SPECIFIED SPECIFICATIONS. CUSTOMERS ARE RESPONSIBLE FOR VERIFYING THE ACTUAL APPLICATION COMPONENT SUBSTITUTION AND PRINTED BOARD MANUFACTURING TOLERANCES TO MEET THE SPECIFIED PERFORMANCE OR RELIABILITY. CONTACT LINEAR TECHNOLOGY APPLICATIONS ENGINEERING FOR ASSISTANCE.

APPROVALS

PRI. DES.	LT
APPNG.	YL

SCALE = NONE

1630 McCarthy Blvd.
Milpitas, CA 95035
Phone: (408)432-1900 www.linear.com
Fax: (408)434-0007
LTC Confidential For Customer Use Only

LINEAR TECHNOLOGY

TITLE: SCHEMATIC
HIGH EFFICIENCY POLYPHASE STEP-DOWN μ MODULE REGULATORS

SIZE	IC NO.	REV.
B	LTM4645EY / LTM4647EY	2

DEMO CIRCUIT 2616A

DATE: Friday, June 09, 2017

SHEET 4 OF 4



ESD Caution

ESD (electrostatic discharge) sensitive device. Charged devices and circuit boards can discharge without detection. Although this product features patented or proprietary protection circuitry, damage may occur on devices subjected to high energy ESD. Therefore, proper ESD precautions should be taken to avoid performance degradation or loss of functionality.

Legal Terms and Conditions

By using the evaluation board discussed herein (together with any tools, components documentation or support materials, the "Evaluation Board"), you are agreeing to be bound by the terms and conditions set forth below ("Agreement") unless you have purchased the Evaluation Board, in which case the Analog Devices Standard Terms and Conditions of Sale shall govern. Do not use the Evaluation Board until you have read and agreed to the Agreement. Your use of the Evaluation Board shall signify your acceptance of the Agreement. This Agreement is made by and between you ("Customer") and Analog Devices, Inc. ("ADI"), with its principal place of business at One Technology Way, Norwood, MA 02062, USA. Subject to the terms and conditions of the Agreement, ADI hereby grants to Customer a free, limited, personal, temporary, non-exclusive, non-sublicensable, non-transferable license to use the Evaluation Board FOR EVALUATION PURPOSES ONLY. Customer understands and agrees that the Evaluation Board is provided for the sole and exclusive purpose referenced above, and agrees not to use the Evaluation Board for any other purpose. Furthermore, the license granted is expressly made subject to the following additional limitations: Customer shall not (i) rent, lease, display, sell, transfer, assign, sublicense, or distribute the Evaluation Board; and (ii) permit any Third Party to access the Evaluation Board. As used herein, the term "Third Party" includes any entity other than ADI, Customer, their employees, affiliates and in-house consultants. The Evaluation Board is NOT sold to Customer; all rights not expressly granted herein, including ownership of the Evaluation Board, are reserved by ADI. CONFIDENTIALITY. This Agreement and the Evaluation Board shall all be considered the confidential and proprietary information of ADI. Customer may not disclose or transfer any portion of the Evaluation Board to any other party for any reason. Upon discontinuation of use of the Evaluation Board or termination of this Agreement, Customer agrees to promptly return the Evaluation Board to ADI. ADDITIONAL RESTRICTIONS. Customer may not disassemble, decompile or reverse engineer chips on the Evaluation Board. Customer shall inform ADI of any occurred damages or any modifications or alterations it makes to the Evaluation Board, including but not limited to soldering or any other activity that affects the material content of the Evaluation Board. Modifications to the Evaluation Board must comply with applicable law, including but not limited to the RoHS Directive. TERMINATION. ADI may terminate this Agreement at any time upon giving written notice to Customer. Customer agrees to return to ADI the Evaluation Board at that time. LIMITATION OF LIABILITY. THE EVALUATION BOARD PROVIDED HEREUNDER IS PROVIDED "AS IS" AND ADI MAKES NO WARRANTIES OR REPRESENTATIONS OF ANY KIND WITH RESPECT TO IT. ADI SPECIFICALLY DISCLAIMS ANY REPRESENTATIONS, ENDORSEMENTS, GUARANTEES, OR WARRANTIES, EXPRESS OR IMPLIED, RELATED TO THE EVALUATION BOARD INCLUDING, BUT NOT LIMITED TO, THE IMPLIED WARRANTY OF MERCHANTABILITY, TITLE, FITNESS FOR A PARTICULAR PURPOSE OR NON-INFRINGEMENT OF INTELLECTUAL PROPERTY RIGHTS. IN NO EVENT WILL ADI AND ITS LICENSORS BE LIABLE FOR ANY INCIDENTAL, SPECIAL, INDIRECT, OR CONSEQUENTIAL DAMAGES RESULTING FROM CUSTOMER'S POSSESSION OR USE OF THE EVALUATION BOARD, INCLUDING BUT NOT LIMITED TO LOST PROFITS, DELAY COSTS, LABOR COSTS OR LOSS OF GOODWILL. ADI'S TOTAL LIABILITY FROM ANY AND ALL CAUSES SHALL BE LIMITED TO THE AMOUNT OF ONE HUNDRED US DOLLARS (\$100.00). EXPORT. Customer agrees that it will not directly or indirectly export the Evaluation Board to another country, and that it will comply with all applicable United States federal laws and regulations relating to exports. GOVERNING LAW. This Agreement shall be governed by and construed in accordance with the substantive laws of the Commonwealth of Massachusetts (excluding conflict of law rules). Any legal action regarding this Agreement will be heard in the state or federal courts having jurisdiction in Suffolk County, Massachusetts, and Customer hereby submits to the personal jurisdiction and venue of such courts. The United Nations Convention on Contracts for the International Sale of Goods shall not apply to this Agreement and is expressly disclaimed.

Mouser Electronics

Authorized Distributor

Click to View Pricing, Inventory, Delivery & Lifecycle Information:

[Analog Devices Inc.:](#)

[DC2616A-A](#)