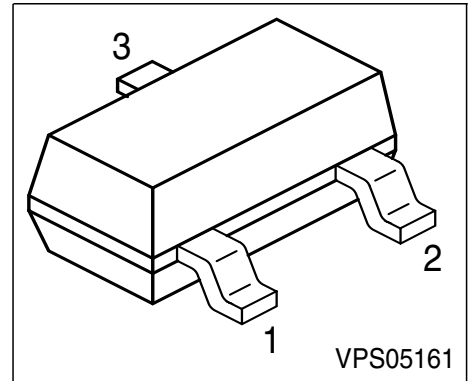
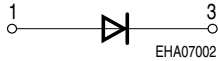
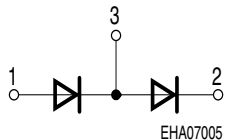

**Silicon Schottky Diodes**

- General-purpose diode for high-speed switching
- Circuit protection
- Voltage clamping
- High-level detecting and mixing

**BAS 40**

EHA07002

**BAS 40-04**

EHA07005

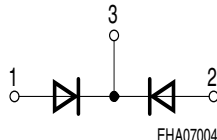
**BAS 40-05**

EHA07004

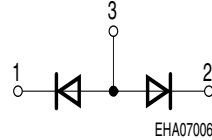
**BAS 40-06**

EHA07006

Type	Marking	Pin Configuration		Package
BAS 40	43s	1 = A	2 n.c.	SOT-23
BAS 40-04	44s	1 = A1	2 = C2	SOT-23
BAS 40-05	45s	1 = A1	2 = A2	SOT-23
BAS 40-06	46s	1 = C1	2 = C2	SOT-23

**Maximum Ratings**

Parameter	Symbol	Value	Unit
Diode reverse voltage	$V_R$	40	V
Forward current	$I_F$	120	mA
Surge forward current, $t \leq 10$ ms	$I_{FSM}$	200	
Total power dissipation BAS 40, $T_S \leq 81^\circ\text{C}$	$P_{tot}$	250	mW
BAS 40-04, BAS 40-05, BAS 40-06, $T_S \leq 55^\circ\text{C}$	$P_{tot}$	250	
Junction temperature	$T_j$	150	$^\circ\text{C}$
Operating temperature range	$T_{op}$	-55 ... 150	
Storage temperature	$T_{stg}$	-55 ... 150	

**Thermal Resistance**

Junction - ambient <sup>1)</sup> BAS 40	$R_{thJA}$	$\leq 345$	K/W
Junction - ambient BAS 40-04 ...	$R_{thJA}$	$\leq 515$	
Junction - soldering point BAS 40	$R_{thJS}$	$\leq 275$	
Junction - soldering point BAS 40-04 ...	$R_{thJS}$	$\leq 375$	

 1) Package mounted on epoxy pcb 40mm x 40mm x 1.5mm / 6cm<sup>2</sup> Cu

**Electrical Characteristics** at  $T_A = 25^\circ\text{C}$ , unless otherwise specified.

Parameter	Symbol	Values			Unit
		min.	typ.	max.	
<b>DC characteristics</b>					
Breakdown voltage $I_{(BR)} = 10 \mu\text{A}$	$V_{(BR)}$	40	-	-	V
Reverse current $V_R = 30 \text{ V}$ $V_R = 40 \text{ V}$	$I_R$	- -	- -	1 10	$\mu\text{A}$
Forward voltage $I_F = 1 \text{ mA}$ $I_F = 10 \text{ mA}$ $I_F = 40 \text{ mA}$	$V_F$	- - -	310 450 720	380 500 1000	mV
<b>AC characteristics</b>					
Diode capacitance $V_R = 0 \text{ V}, f = 1 \text{ MHz}$	$C_T$	-	4	5	pF
Charge carrier life time $I_F = 25 \text{ mA}$	$\tau$	-	-	100	ps
Differential forward resistance $I_F = 10 \text{ mA}, f = 10 \text{ kHz}$	$R_F$	-	10	-	$\Omega$

**Forward current  $I_F = f(V_F)$**

$T_A = 25^\circ\text{C}$

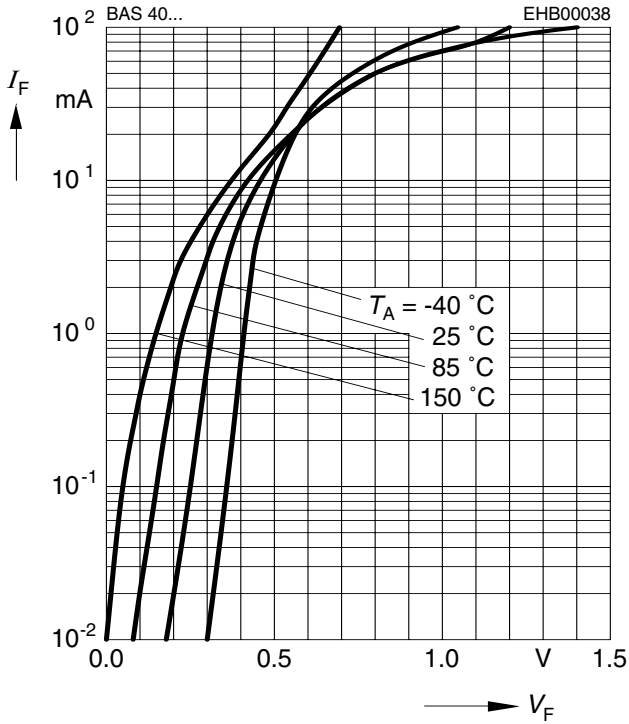

**Reverse current  $I_R = f(V_R)$**

$T_A = \text{Parameter}$

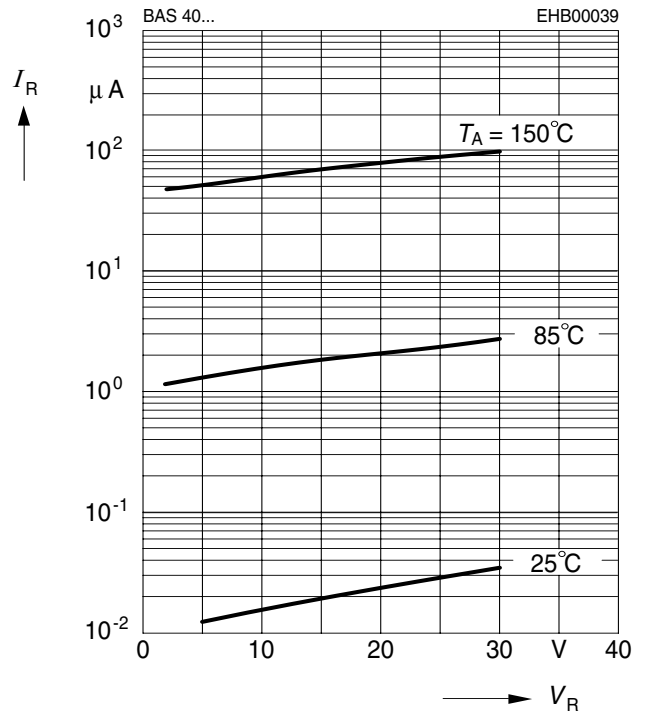

**Diode capacitance  $C_T = f(V_R)$**

$f = 1\text{MHz}$

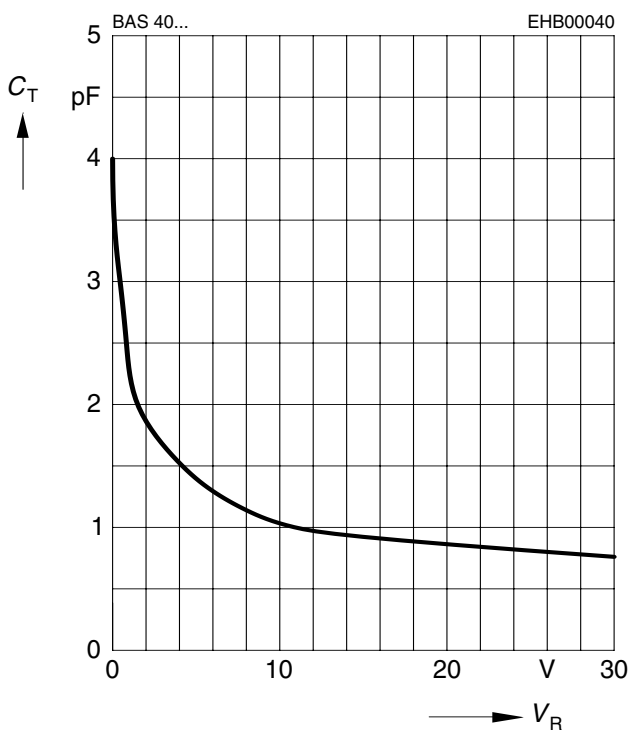

**Differential forward resistance  $r_f = f(I_F)$**

$f = 10\text{kHz}$

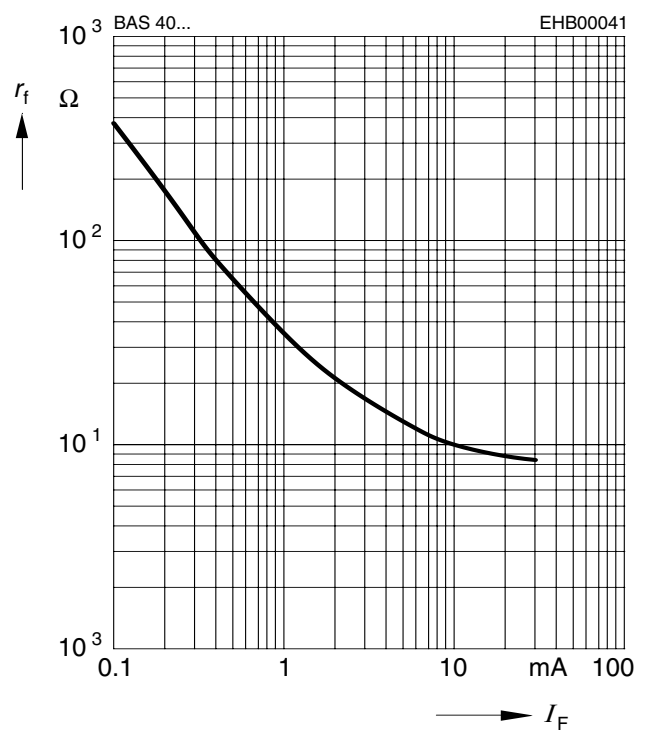

**Forward current  $I_F = f(T_A^*; T_S)$**

\* Package mounted on epoxy

