

IRIS

~5° real spot beam optimized for CREE XP-E.
Assembly with holder and installation tape.

TECHNICAL SPECIFICATIONS:

Dimensions	Ø 38.0 mm
Height	27.1 mm
Fastening	glue, tape, pin, screw
ROHS compliant	yes ⓘ



MATERIAL SPECIFICATIONS:

Component	Type	Material	Colour	Finish
IRIS	Single lens	PMMA	clear	
IRIS-XP-HLD-TAPE	Assembly	PC	black	



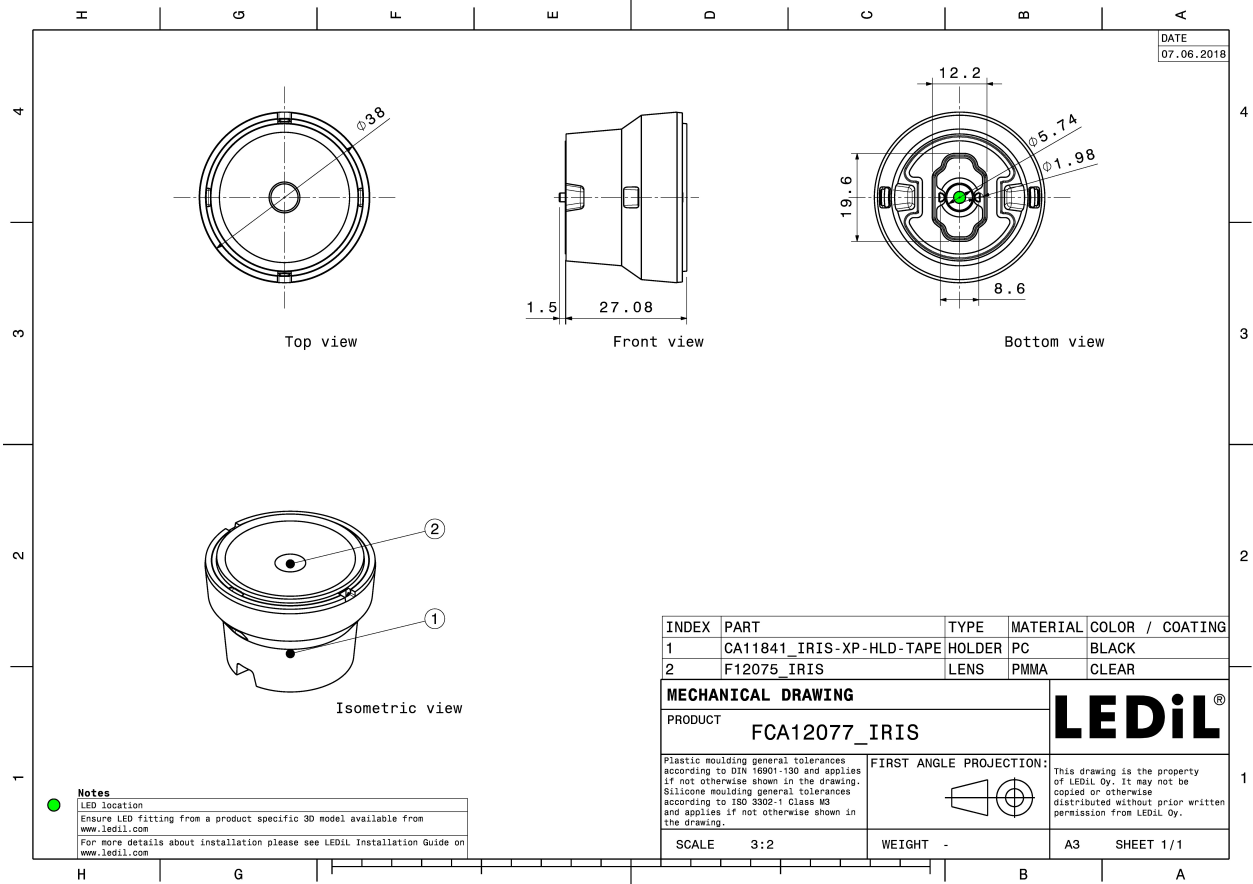

ORDERING INFORMATION:

Component		Qty in box	MOQ	MPQ	Box weight (kg)
FCA12077_IRIS	Single lens	378	126	42	8.9
» Box size: 480 x 280 x 300 mm					



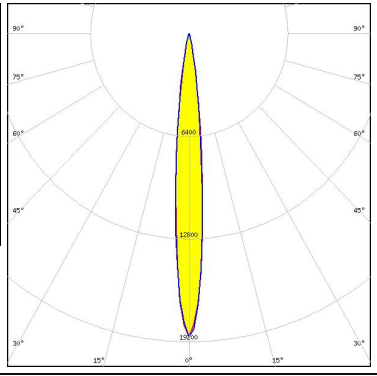

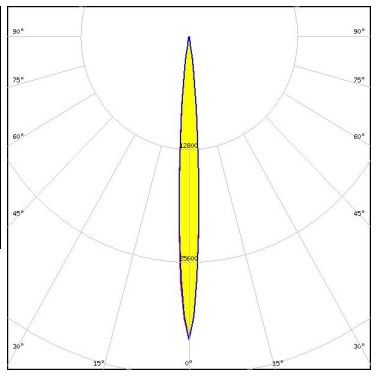

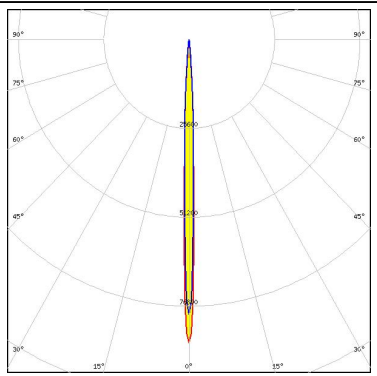
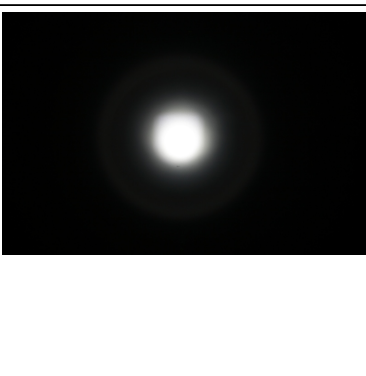
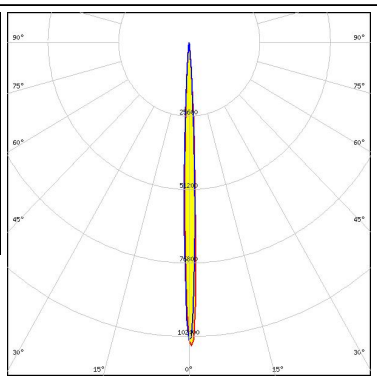

See also our general installation guide: www.ledil.com/installation_guide

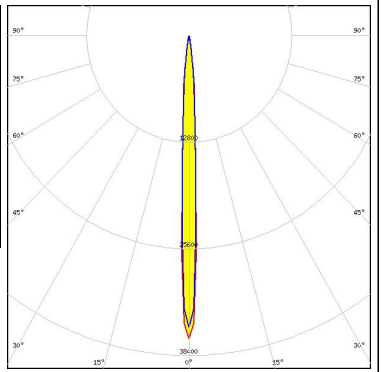

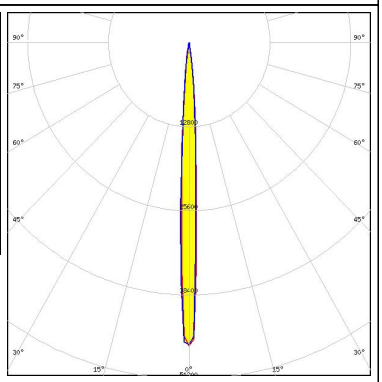

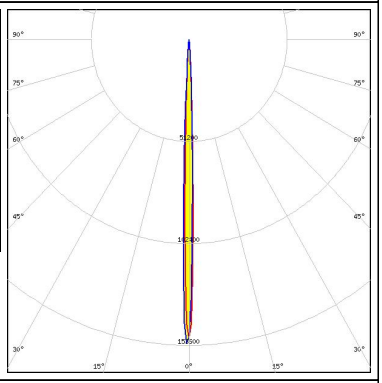

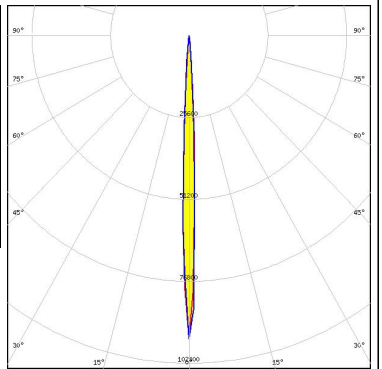
PHOTOMETRIC DATA (MEASURED):

<p>CREE → LED</p> <p>LED XHP35 HD FWHM / FWTM 10.0° / 23.0° Efficiency 89 % Peak intensity 18.6 cd/lm LEDs/each optic 1 Light colour White Required components:</p>		
<p>CREE → LED</p> <p>LED XHP35 HI FWHM / FWTM 7.6° / 17.0° Efficiency 90 % Peak intensity 35.9 cd/lm LEDs/each optic 1 Light colour White Required components:</p>		
<p>CREE → LED</p> <p>LED XP-E FWHM / FWTM 4.0° / 9.0° Efficiency 93 % Peak intensity 87.4 cd/lm LEDs/each optic 1 Light colour White Required components:</p>		
<p>CREE → LED</p> <p>LED XP-E2 FWHM / FWTM 5.0° / 9.0° Efficiency 93 % Peak intensity 103.9 cd/lm LEDs/each optic 1 Light colour White Required components:</p>		

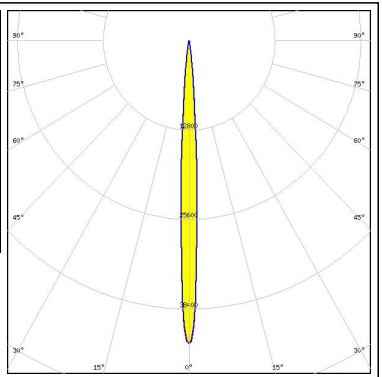
PHOTOMETRIC DATA (MEASURED):

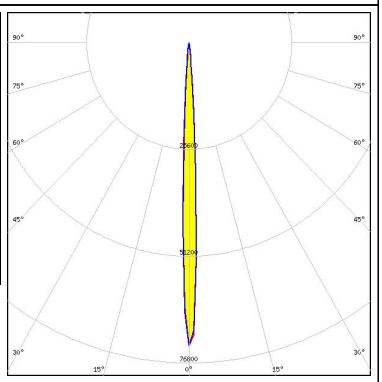
<p>CREE ⇄ LED</p> <p>LED XP-G FWHM / FWTM 6.0° / 14.0° Efficiency 94 % Peak intensity 46.4 cd/lm LEDs/each optic 1 Light colour White Required components:</p>		
<p>CREE ⇄ LED</p> <p>LED XP-G2 FWHM / FWTM 6.0° / 14.0° Efficiency 95 % Peak intensity 46 cd/lm LEDs/each optic 1 Light colour White Required components:</p>		
<p>CREE ⇄ LED</p> <p>LED XP-P FWHM / FWTM 3.0° / 8.0° Efficiency 96 % Peak intensity 152.7 cd/lm LEDs/each optic 1 Light colour White Required components:</p>		
<p>CREE ⇄ LED</p> <p>LED XQ-E HI FWHM / FWTM 3.9° / 9.0° Efficiency 88 % Peak intensity 123.3 cd/lm LEDs/each optic 1 Light colour White Required components:</p>		

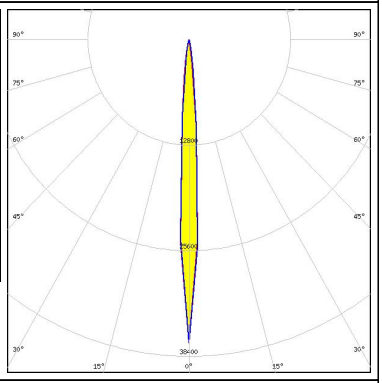

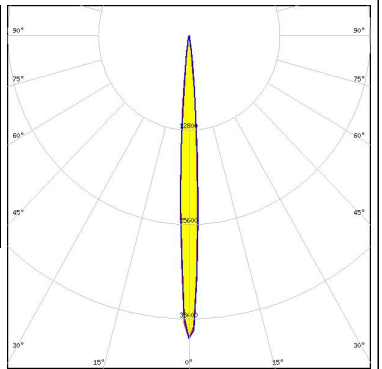

PHOTOMETRIC DATA (MEASURED):

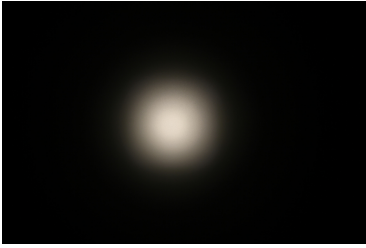
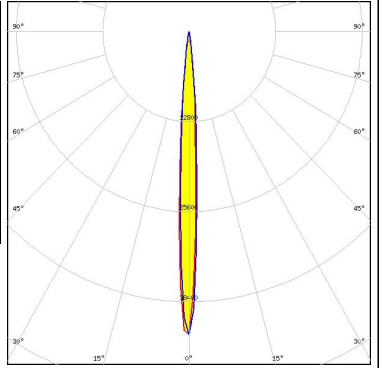
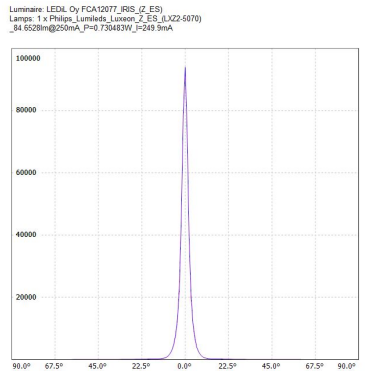
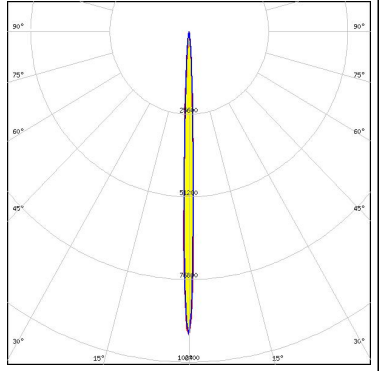
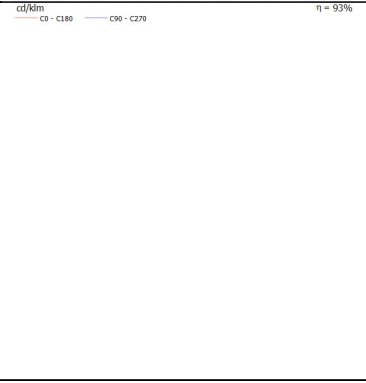
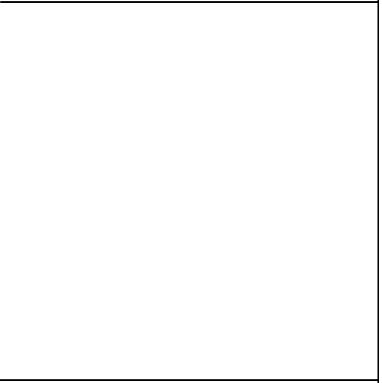
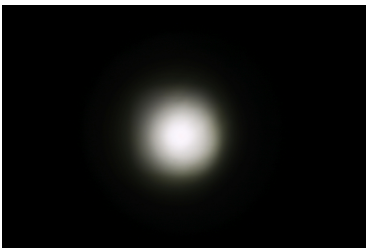
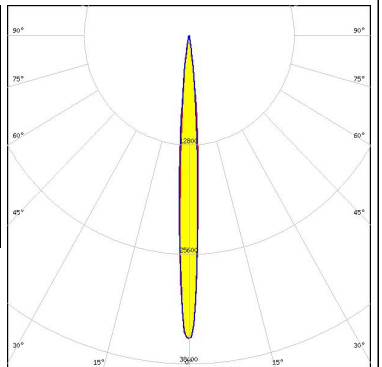
<p>CREE LED</p> <p>LED XT-E FWHM / FWTM 6.0° / 13.0° Efficiency 91 % Peak intensity 44 cd/lm LEDs/each optic 1 Light colour White Required components:</p>		
<p>LUMILEDS</p> <p>LED LUXEON Rebel FWHM / FWTM 5.0° / 9.0° Efficiency % Peak intensity 75.6 cd/lm LEDs/each optic 1 Light colour White Required components:</p>		
<p>LUMILEDS</p> <p>LED LUXEON Rebel ES FWHM / FWTM 7.0° / 14.0° Efficiency 93 % Peak intensity 38.5 cd/lm LEDs/each optic 1 Light colour White Required components:</p>		
<p>LUMILEDS</p> <p>LED LUXEON T FWHM / FWTM 7.0° / 14.0° Efficiency 94 % Peak intensity 40.2 cd/lm LEDs/each optic 1 Light colour White Required components:</p>		

PHOTOMETRIC DATA (MEASURED):

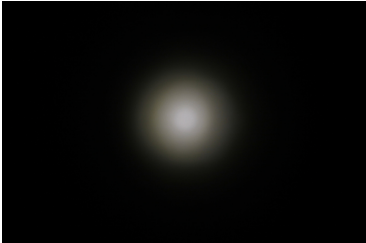
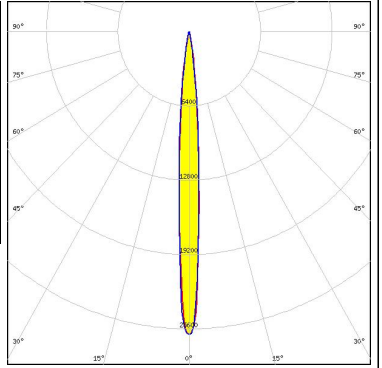
<p>LUMILEDS</p> <p>LED LUXEON TX</p> <p>FWHM / FWTM 6.9° / 15.0°</p> <p>Efficiency 89 %</p> <p>Peak intensity 43.1 cd/lm</p> <p>LEDs/each optic 1</p> <p>Light colour White</p> <p>Required components:</p>		
<p>LUMILEDS</p> <p>LED LUXEON Z ES</p> <p>FWHM / FWTM 4.0° / 9.0°</p> <p>Efficiency 93 %</p> <p>Peak intensity 94.1 cd/lm</p> <p>LEDs/each optic 1</p> <p>Light colour White</p> <p>Required components:</p>	<p>Luminaire: LEDiL Oy FCA12077_IRIS_Z_ES Lamps: 1 x Philips Lumileds Luxeon Z ES (LX22-5070) _S4_6528lm@250mA_P=4.7304E3W_P=248 mA</p> 	
<p>NICHIA</p> <p>LED NCSxx19A</p> <p>FWHM / FWTM 5.0° / 11.0°</p> <p>Efficiency %</p> <p>LEDs/each optic 1</p> <p>Light colour White</p> <p>Required components:</p>		
<p>NICHIA</p> <p>LED NVSW219F</p> <p>FWHM / FWTM 7.0° / 16.0°</p> <p>Efficiency 94 %</p> <p>Peak intensity 35.7 cd/lm</p> <p>LEDs/each optic 1</p> <p>Light colour White</p> <p>Required components:</p>		

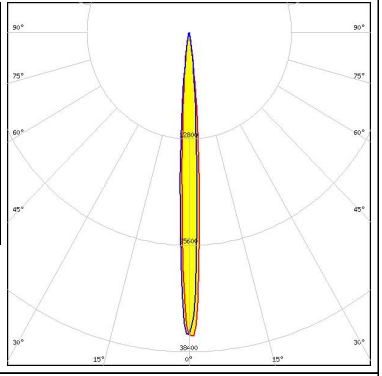
PHOTOMETRIC DATA (MEASURED):

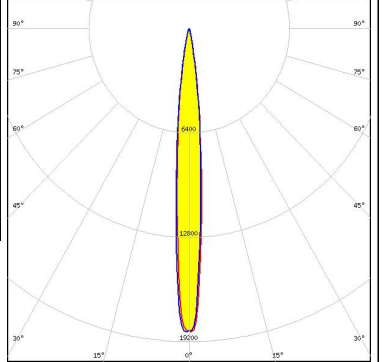
<p>NICHIA</p> <p>LED NVSW3x9A FWHM / FWTM 8.0° / 18.0° Efficiency 89 % Peak intensity 26.3 cd/lm LEDs/each optic 1 Light colour White Required components:</p>		
<p>NICHIA</p> <p>LED NVSxx19A FWHM / FWTM 6.0° / 14.0° Efficiency 93 % Peak intensity 38.7 cd/lm LEDs/each optic 1 Light colour White Required components:</p>		
<p>NICHIA</p> <p>LED NVSxx19B/NVSxx19C FWHM / FWTM 7.0° / 15.0° Efficiency 92 % Peak intensity 36.6 cd/lm LEDs/each optic 1 Light colour White Required components:</p>		
<p>NICHIA</p> <p>LED NWSx229A FWHM / FWTM 10.0° / 21.0° Efficiency 91 % Peak intensity 18.6 cd/lm LEDs/each optic 1 Light colour White Required components:</p>		

PHOTOMETRIC DATA (MEASURED):

OSRAM

Opto Semiconductors

LED OSLON Square EC
 FWHM / FWTM 6.0° / 12.0°
 Efficiency 92 %
 Peak intensity 52 cd/lm
 LEDs/each optic 1
 Light colour White
 Required components:

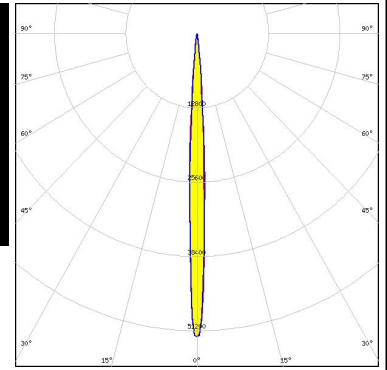

OSRAM

Opto Semiconductors

LED OSLON SSL 150
 FWHM / FWTM 4.0° / 9.0°
 Efficiency 94 %
 Peak intensity 101 cd/lm
 LEDs/each optic 1
 Light colour White
 Required components:

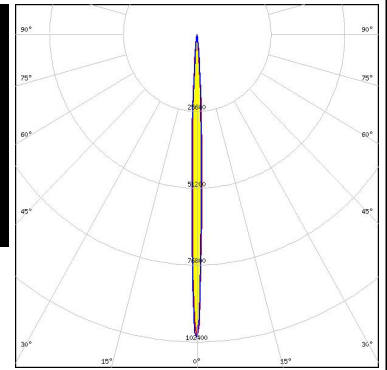

OSRAM

Opto Semiconductors

LED OSLON SSL 80
 FWHM / FWTM 4.0° / 9.0°
 Efficiency 90 %
 Peak intensity 89 cd/lm
 LEDs/each optic 1
 Light colour White
 Required components:

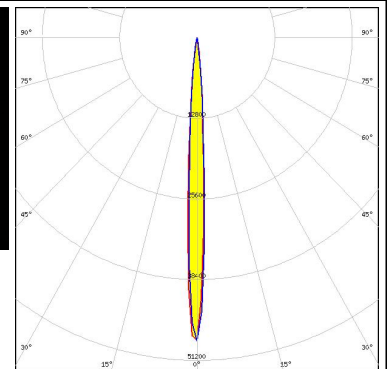

SAMSUNG

LED LH351Z
 FWHM / FWTM 7.0° / 15.0°
 Efficiency 89 %
 Peak intensity 48.1 cd/lm
 LEDs/each optic 1
 Light colour White
 Required components:

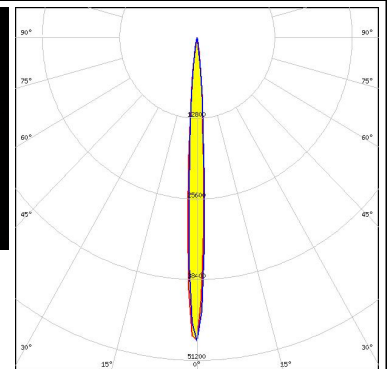

PHOTOMETRIC DATA (MEASURED):

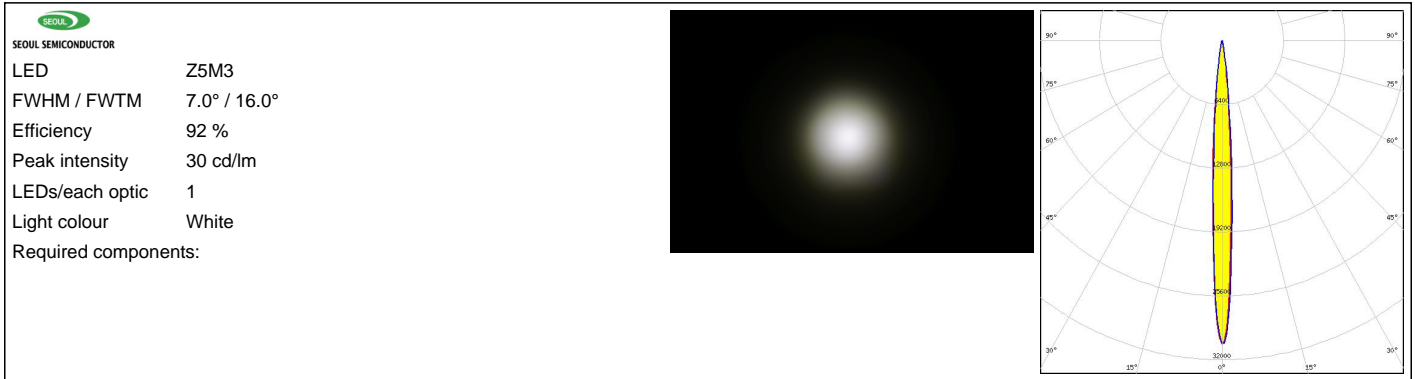

PHOTOMETRIC DATA (SIMULATED):

CREE LED

LED: XD16
 FWHM / FWTM: 6.0° / 14.0°
 Efficiency: 91 %
 Peak intensity: 47.9 cd/lm
 LEDs/each optic: 1
 Light colour: White
 Required components:

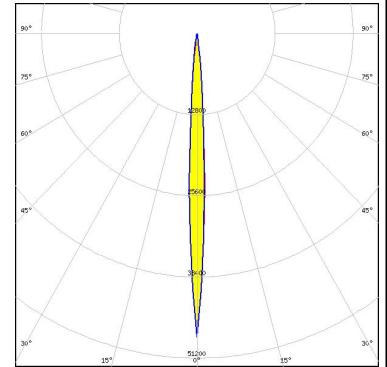

CREE LED

LED: XP-G2 HE
 FWHM / FWTM: 8.0° / 18.0°
 Efficiency: 92 %
 Peak intensity: 29.7 cd/lm
 LEDs/each optic: 1
 Light colour: White
 Required components:

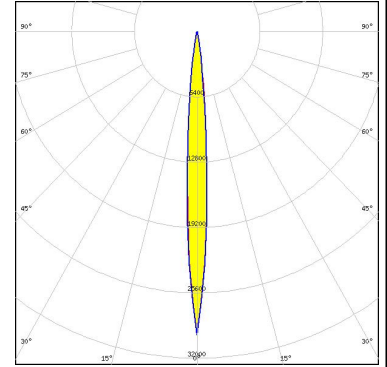

CREE LED

LED: XP-G3
 FWHM / FWTM: 7.7° / 18.0°
 Efficiency: 91 %
 Peak intensity: 28.7 cd/lm
 LEDs/each optic: 1
 Light colour: White
 Required components:

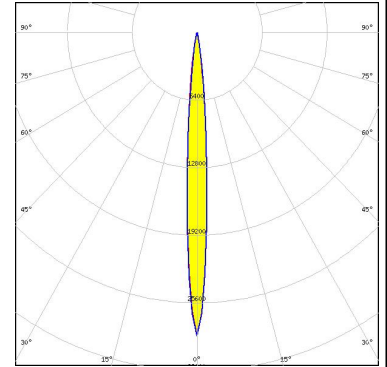

CREE LED

LED: XP-L HD
 FWHM / FWTM: 8.6° / 19.0°
 Efficiency: 93 %
 Peak intensity: 25.3 cd/lm
 LEDs/each optic: 1
 Light colour: White
 Required components:

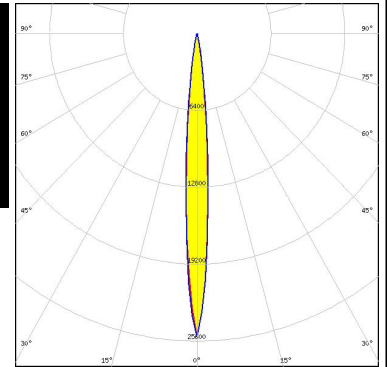

PHOTOMETRIC DATA (SIMULATED):



LED XQ-E HD
 FWHM / FWTM 5.3° / 11.0°
 Efficiency 94 %
 Peak intensity 77.8 cd/lm
 LEDs/each optic 1
 Light colour White
 Required components:

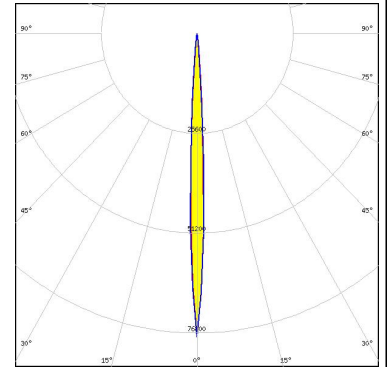

LED XQ-E HD
 FWHM / FWTM 5.0° / 11.5°
 Efficiency 93 %
 Peak intensity 80 cd/lm
 LEDs/each optic 1
 Light colour White
 Required components:



LED LUXEON H50-2
 FWHM / FWTM 7.0° / 15.0°
 Efficiency 94 %
 Peak intensity 38.6 cd/lm
 LEDs/each optic 1
 Light colour White
 Required components:

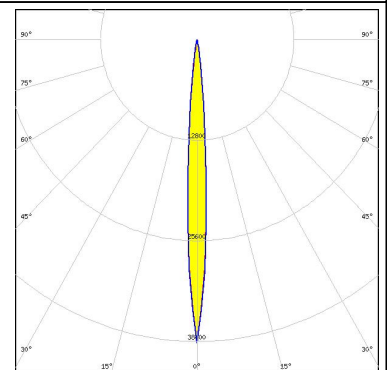

LED LUXEON SunPlus 20 Line (150 deg)
 FWHM / FWTM 6.0° / 14.0°
 Efficiency 90 %
 Peak intensity 42.7 cd/lm
 LEDs/each optic 1
 Light colour White
 Required components:

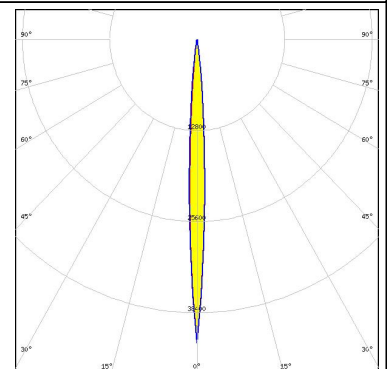

PHOTOMETRIC DATA (SIMULATED):

<p>LUMILEDS</p> <p>LED LUXEON SunPlus 35 Line FWHM / FWTM 6.0° / 15.0° Efficiency 94 % Peak intensity 49.9 cd/lm LEDs/each optic 1 Light colour Blue Required components:</p>	
<p>LUMINUS</p> <p>LED SST-10-B130 FWHM / FWTM 6.0° / 13.0° Efficiency 94 % LEDs/each optic 1 Light colour IR Required components:</p>	
<p>LUMINUS</p> <p>LED SST-20 FWHM / FWTM 6.0° / 14.0° Efficiency 93 % Peak intensity 48.4 cd/lm LEDs/each optic 1 Light colour White Required components:</p>	
<p>OSRAM Opto Semiconductors</p> <p>LED Duris S5 (Single chip) FWHM / FWTM 6.0° / 14.0° Efficiency 94 % Peak intensity 48.2 cd/lm LEDs/each optic 1 Light colour Yellow Required components:</p>	

PHOTOMETRIC DATA (SIMULATED):

OSRAM

Opto Semiconductors

LED Duris S5 (Single chip)
 FWHM / FWTM 4.0° / 12.0°
 Efficiency 93 %
 Peak intensity 74.7 cd/lm
 LEDs/each optic 1
 Light colour Red
 Required components:

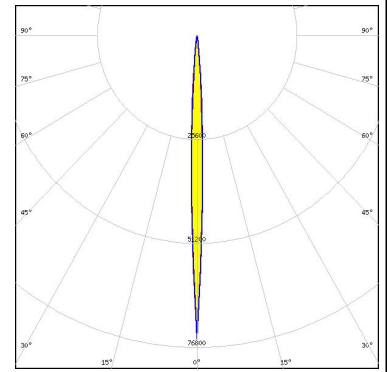

OSRAM

Opto Semiconductors

LED Duris S5 (Single chip)
 FWHM / FWTM 4.0° / 12.0°
 Efficiency 93 %
 Peak intensity 72.5 cd/lm
 LEDs/each optic 1
 Light colour Green
 Required components:

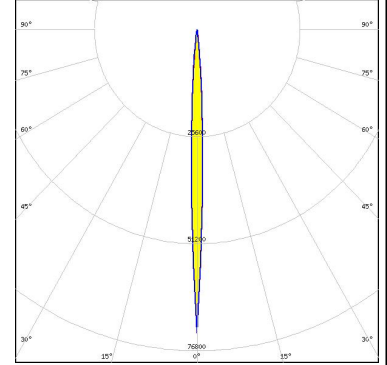

OSRAM

Opto Semiconductors

LED OSCONIQ P 3737 (2W version)
 FWHM / FWTM 6.0° / 14.0°
 Efficiency 94 %
 Peak intensity 46.2 cd/lm
 LEDs/each optic 1
 Light colour White
 Required components:

OSRAM

Opto Semiconductors

LED OSLON Black Flat
 FWHM / FWTM 6.0° / 14.0°
 Efficiency 94 %
 Peak intensity 48.9 cd/lm
 LEDs/each optic 1
 Light colour White
 Required components:

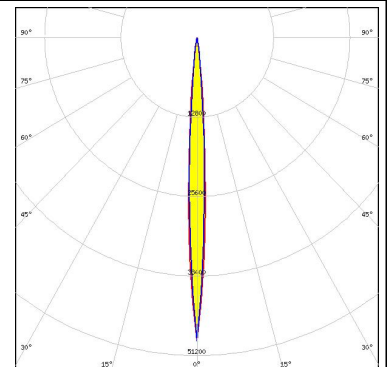

PHOTOMETRIC DATA (SIMULATED):

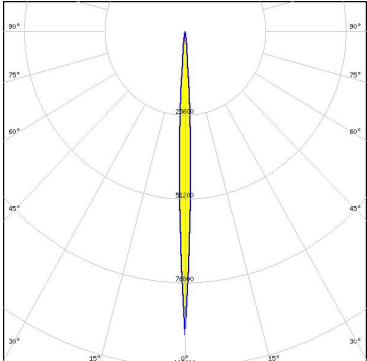
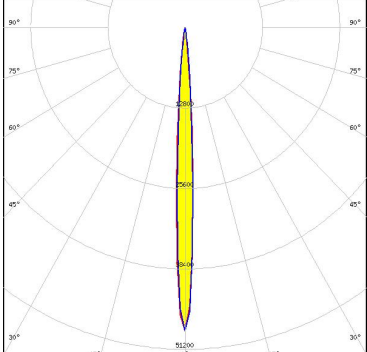
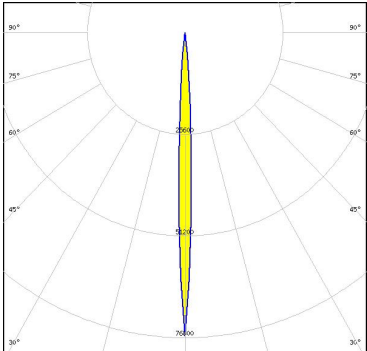
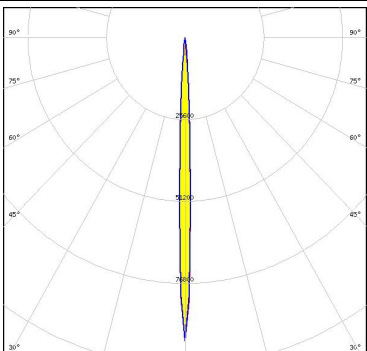
<p>OSRAM Opto Semiconductors</p> <p>LED OSLO[®]N Black Flat</p> <p>FWHM / FW_{TM} 4.2° / 10.0°</p> <p>Efficiency 94 %</p> <p>Peak intensity 92 cd/lm</p> <p>LEDs/each optic 1</p> <p>Light colour White</p> <p>Required components:</p>	
<p>OSRAM Opto Semiconductors</p> <p>LED OSLO[®]N Square CSSRM2/CSSRM3</p> <p>FWHM / FW_{TM} 6.4° / 14.0°</p> <p>Efficiency 94 %</p> <p>Peak intensity 48.3 cd/lm</p> <p>LEDs/each optic 1</p> <p>Light colour White</p> <p>Required components:</p>	
<p>OSRAM Opto Semiconductors</p> <p>LED OSTAR Projection Compact (Kx.CSLNM1.xx)</p> <p>FWHM / FW_{TM} 6.0° / 12.0°</p> <p>Efficiency 94 %</p> <p>Peak intensity 76.4 cd/lm</p> <p>LEDs/each optic 1</p> <p>Light colour White</p> <p>Required components:</p>	
<p>OSRAM Opto Semiconductors</p> <p>LED OSTAR Projection Compact (Kx.CSLNM1.xx)</p> <p>FWHM / FW_{TM} 4.0° / 10.0°</p> <p>Efficiency 93 %</p> <p>Peak intensity 94.8 cd/lm</p> <p>LEDs/each optic 1</p> <p>Light colour White</p> <p>Required components:</p>	

PHOTOMETRIC DATA (SIMULATED):

OSRAM

Opto Semiconductors

LED SFH 4716AS
 FWHM / FWTM 6.0° / 12.0°
 Efficiency 94 %
 LEDs/each optic 1
 Light colour IR
 Required components:

SAMSUNG

LED LH351C
 FWHM / FWTM 8.0° / 18.0°
 Efficiency 93 %
 Peak intensity 31.2 cd/lm
 LEDs/each optic 1
 Light colour White
 Required components:

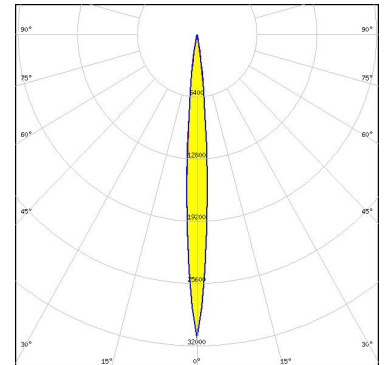

SAMSUNG

LED LH351D
 FWHM / FWTM 9.3° / 21.0°
 Efficiency 90 %
 Peak intensity 21 cd/lm
 LEDs/each optic 1
 Light colour White
 Required components:

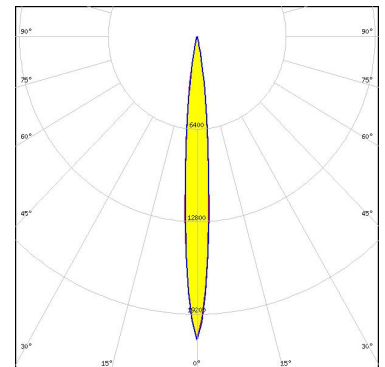

SEOUL SEMICONDUCTOR

LED Z8Y22P
 FWHM / FWTM 8.0°
 Efficiency 98 %
 Peak intensity 29.9 cd/lm
 LEDs/each optic 1
 Light colour White
 Required components:

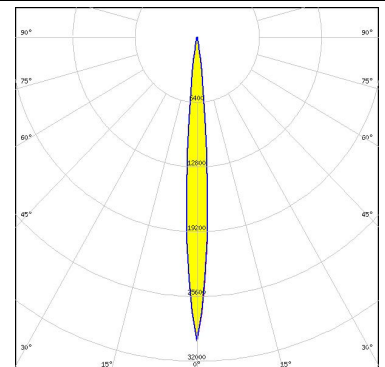

GENERAL INFORMATION:

NOTE: The typical beam angle will be changed by different color, chip size and chip position tolerance. The typical total beam angle is the full angle measured where the luminous intensity is half of the peak value.

MATERIALS:

As part of our continuous research and improvement processes, and to ensure the best possible quality and availability of our products, LEDiL reserves the right to change material grades without notice.

PRODUCT DATA USER AGREEMENT AND DISCLAIMER:

The measured data in the provided downloadable LEDiL Product Datasheets and Mechanical 2D-Drawings is rounded and provided as reference for planning. LEDiL Oy's optical specifications have been verified by conducting performance testing of the products in accordance with the company's quality system. The reported data are averaged results of multiple measurements with typical variation. LEDiL Oy reserves the right to without prior notification make changes and improvements to its products.

LEDiL Oy assumes neither warranty, nor guarantee nor any other liability of any kind for the contents and correctness of the provided data. The provided data has been generated with highest diligence but the provided data may in reality not represent the complete possible variation range of all intrinsic parameters. Therefore, in certain cases a deviation from the provided data could occur.

LEDiL Oy reserves the right to undertake technical changes of its products without further notification which could lead to changes in the provided data. LEDiL Oy assumes no liability of any kind for the possible deviation from any provided data or any other damage resulting from the usage of the provided data.

The user agrees to this disclaimer and user agreement with the download or usage of the provided files.

LEDiL Oy

Joensuunkatu 13
FI-24240 SALO
Finland

LEDiL Inc.

228 West Page Street
Suite D
Sycamore IL 60178
USA

Ledil Optics Technology (Shenzhen) Co., Ltd.

405 , Block B
Casic Motor Building
Shenzhen 518057
P.R.CHINA

Local sales and technical support

[www.ledil.com/
where_to_buy](http://www.ledil.com/where_to_buy)

Shipping locations

Salo, Finland
Hong Kong, China

Distribution Partners

[www.ledil.com/
where_to_buy](http://www.ledil.com/where_to_buy)

Mouser Electronics

Authorized Distributor

Click to View Pricing, Inventory, Delivery & Lifecycle Information:

[Ledi:](#)

[FCA12077_IRIS](#)