

# Protection Device

TVS (Transient Voltage Suppressor)

## ESD128-B1-W0201

Bi-directional, 18 V (AC), 13 V (DC), 0.3 pF, 0201, RoHS and Halogen Free compliant

ESD128-B1-W0201

## Data Sheet

Revision 1.3, 2016-04-06  
Final

**Edition 2016-04-06**

**Published by**

**Infineon Technologies AG**

**81726 Munich, Germany**

**© 2016 Infineon Technologies AG**

**All Rights Reserved.**

### **Information**

For further information on technology, delivery terms and conditions and prices, please contact the nearest Infineon Technologies Office ([www.infineon.com](http://www.infineon.com))

### **Warnings**

Due to technical requirements, components may contain dangerous substances. For information on the types in question, please contact the nearest Infineon Technologies Office.

Infineon Technologies components may be used in life-support devices or systems only with the express written approval of Infineon Technologies, if a failure of such components can reasonably be expected to cause the failure of that life-support device or system or to affect the safety or effectiveness of that device or system. Life support devices or systems are intended to be implanted in the human body or to support and/or maintain and sustain and/or protect human life. If they fail, it is reasonable to assume that the health of the user or other persons may be endangered.

# 1 Product Overview

## 1.1 Features

- ESD / transient protection of high speed data lines according to:
  - IEC61000-4-2 (ESD):  $\pm 15$  kV (air/contact discharge)
  - IEC61000-4-4 (EFT):  $\pm 2$  kV /  $\pm 40$  A(5/50 ns)
  - IEC61000-4-5 (surge):  $\pm 2$  A (8/20  $\mu$ s)
- Bi-directional working voltage up to:  $V_{RWM} = \pm 18$  V (AC),  $\pm 13$  V (DC)
- Line capacitance:  $C_L = 0.3$  pF (typical) at  $f = 1$  MHz
- Clamping voltage:  $V_{CL} = 32$  V (typical) at  $I_{TLP} = 16$  A with  $R_{DYN} = 0.85$   $\Omega$  (typical)
- Very low reverse current.  $I_R < 1$  nA (typical)
- Minimized clamping overshoot due to extremely low parasitic inductance
- Small form factor SMD Size 0201 and low profile (0.58 mm x 0.28 mm x 0.15 mm)
- Bidirectional and symmetric I/V characteristics for optimized design and assembly
- Pb-free (RoHS compliant) and halogen free package



Guidelines for optimized PCB design and assembly process available [\[2\]](#)



## 1.2 Application Examples

- ESD Protection of RF signal lines in Near Field Communication (NFC) applications [\[3\]](#)

## 1.3 Product Description

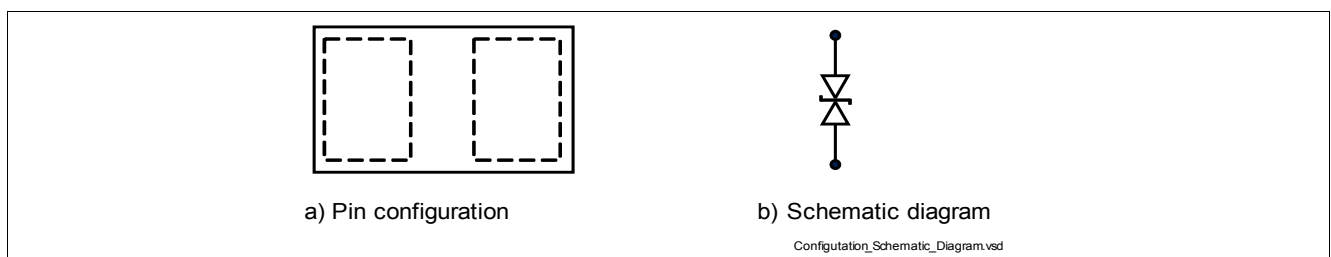

Figure 1-1 Pin Configuration and Schematic Diagram

Table 1-1 Part Information

Type	Package	Configuration	Marking code
ESD128-B1-W0201	WLL-2-1	1 line, bi-directional	K <sup>1)</sup>

1) The device does not have any marking or date code on the device backside. The Marking code is on pad side.

## 2 Maximum Ratings

**Table 2-1 Maximum Ratings at  $T_A = 25\text{ }^\circ\text{C}$ , unless otherwise specified<sup>1)</sup>**

Parameter	Symbol	Values	Unit
Reverse working voltage	$V_{RWM}$	$\pm 18^{2)}$ $\pm 13^{3)}$	V
ESD (air / contact) discharge <sup>4)</sup>	$V_{ESD}$	$\pm 15$	kV
Peak pulse power <sup>5)</sup>	$P_{PK}$	53	W
Peak pulse current <sup>5)</sup>	$I_{PP}$	$\pm 2$	A
Operating temperature range	$T_{OP}$	-55 to 125	$^\circ\text{C}$
Storage temperature	$T_{stg}$	-65 to 150	$^\circ\text{C}$

- 1) Device is electrically symmetrical
- 2) For RF peak voltage (NFC)
- 3) For DC voltage
- 4)  $V_{ESD}$  according to IEC61000-4-2
- 5) Stress pulse: 8/20 $\mu\text{s}$  current waveform according to IEC61000-4-5

**Attention: Stresses above the max. values listed here may cause permanent damage to the device. Exposure to absolute maximum rating conditions for extended periods may affect device reliability. Maximum ratings are absolute ratings; exceeding only one of these values may cause irreversible damage to the integrated circuit.**

## 3 Electrical Characteristics at $T_A = 25\text{ }^\circ\text{C}$ , unless otherwise specified

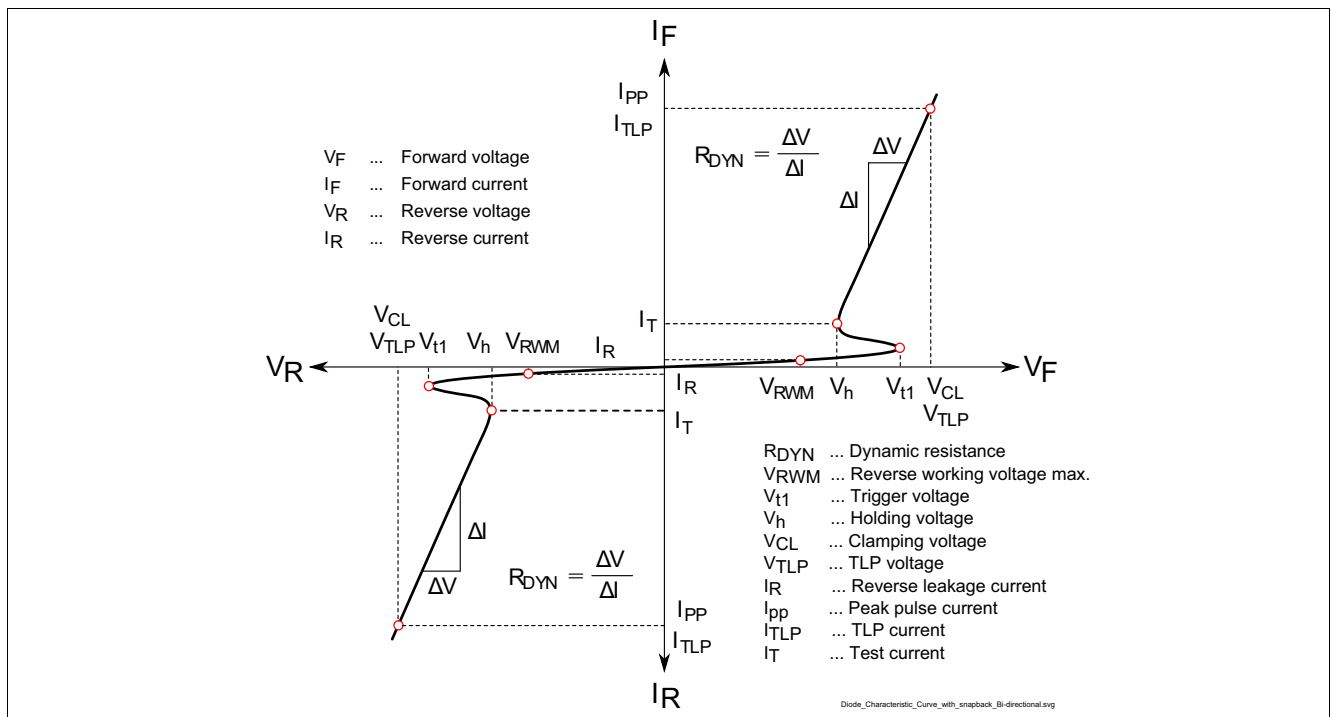

**Figure 3-1 Definitions of electrical characteristics**

Electrical Characteristics at  $T_A = 25\text{ °C}$ , unless otherwise specified

**Table 3-1 DC Characteristics at  $T_A = 25\text{ °C}$ , unless otherwise specified<sup>1)</sup>**

Parameter	Symbol	Values			Unit	Note / Test Condition
		Min.	Typ.	Max.		
Reverse current	$I_R$	–	<1	30	nA	$V_R = 18\text{ V}$
Trigger voltage	$V_{t1}$	20	22	–	V	
Holding voltage	$V_h$	13	17	21	V	$I_T = 40\text{ mA}$

1) Device is electrically symmetrical

**Table 3-2 AC Characteristics at  $T_A = 25\text{ °C}$ , unless otherwise specified**

Parameter	Symbol	Values			Unit	Note / Test Condition
		Min.	Typ.	Max.		
Line capacitance	$C_L$	0.15	0.3	0.5	pF	$V_R = 0\text{ V}, f = 1\text{ MHz}$
		–	0.3	–		$V_R = 0\text{ V}, f = 1\text{ GHz}$

**Table 3-3 ESD and Surge Characteristics at  $T_A = 25\text{ °C}$ , unless otherwise specified<sup>1)</sup>**

Parameter	Symbol	Values			Unit	Note / Test Condition
		Min.	Typ.	Max.		
Clamping voltage <sup>2)</sup>	$V_{CL}$	–	32	–	V	$I_{TLP} = 16\text{ A}, t_p = 100\text{ ns}$
Clamping voltage <sup>3)</sup>		–	18.5	–		$I_{PP} = 1\text{ A}, t_p = 8/20\text{ }\mu\text{s}$
Dynamic resistance <sup>2)</sup>	$R_{DYN}$	–	0.85	–	$\Omega$	$t_p = 100\text{ ns}$

1) Device is electrically symmetrical

 2) Please refer to Application Note AN210[1]. TLP parameter:  $Z_0 = 50\text{ }\Omega$ ,  $t_p = 100\text{ ns}$ ,  $t_r = 0.6\text{ ns}$ .

 3) Stress pulse: 8/20 $\mu\text{s}$  current waveform according to IEC61000-4-5

## 4 Typical Characteristics Diagrams

Typical characteristics diagrams at  $T_A = 25\text{ }^\circ\text{C}$ , unless otherwise specified

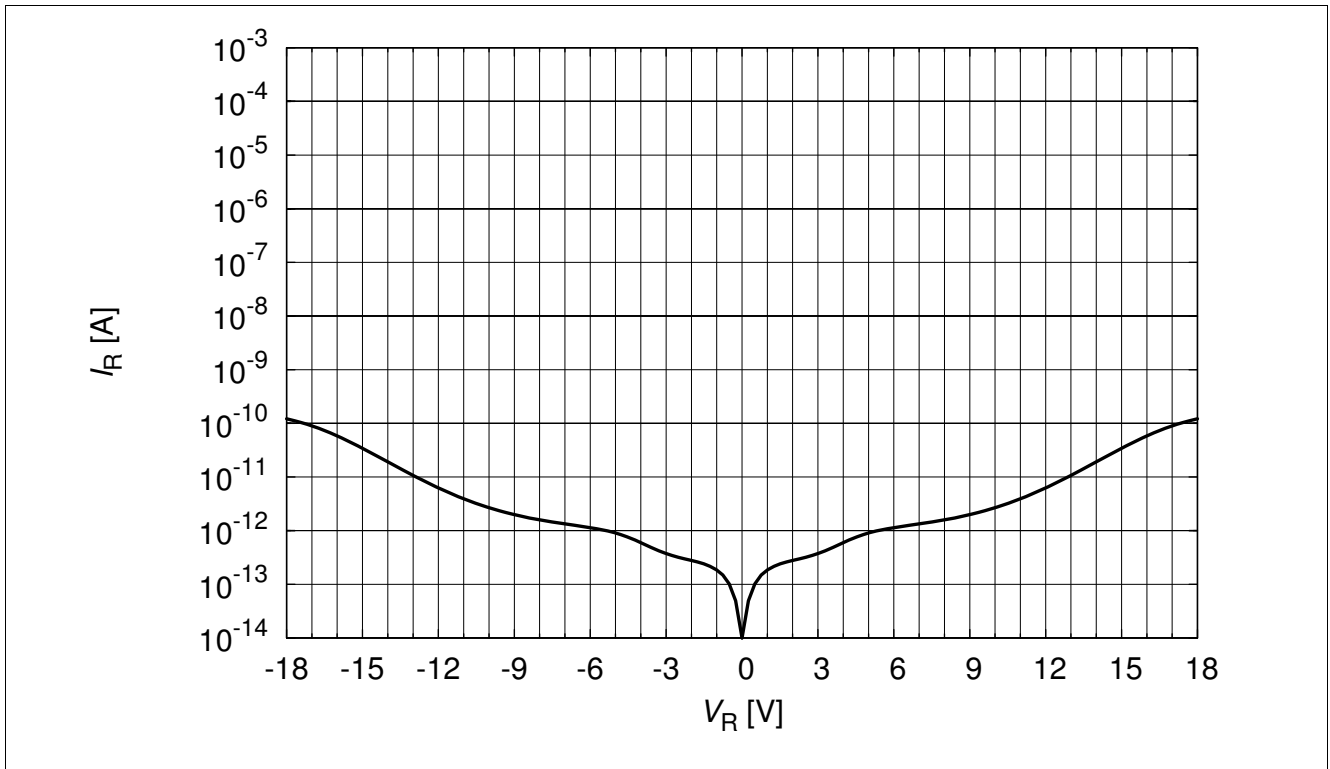

Figure 4-1 Reverse leakage current  $I_R = f(V_R)$

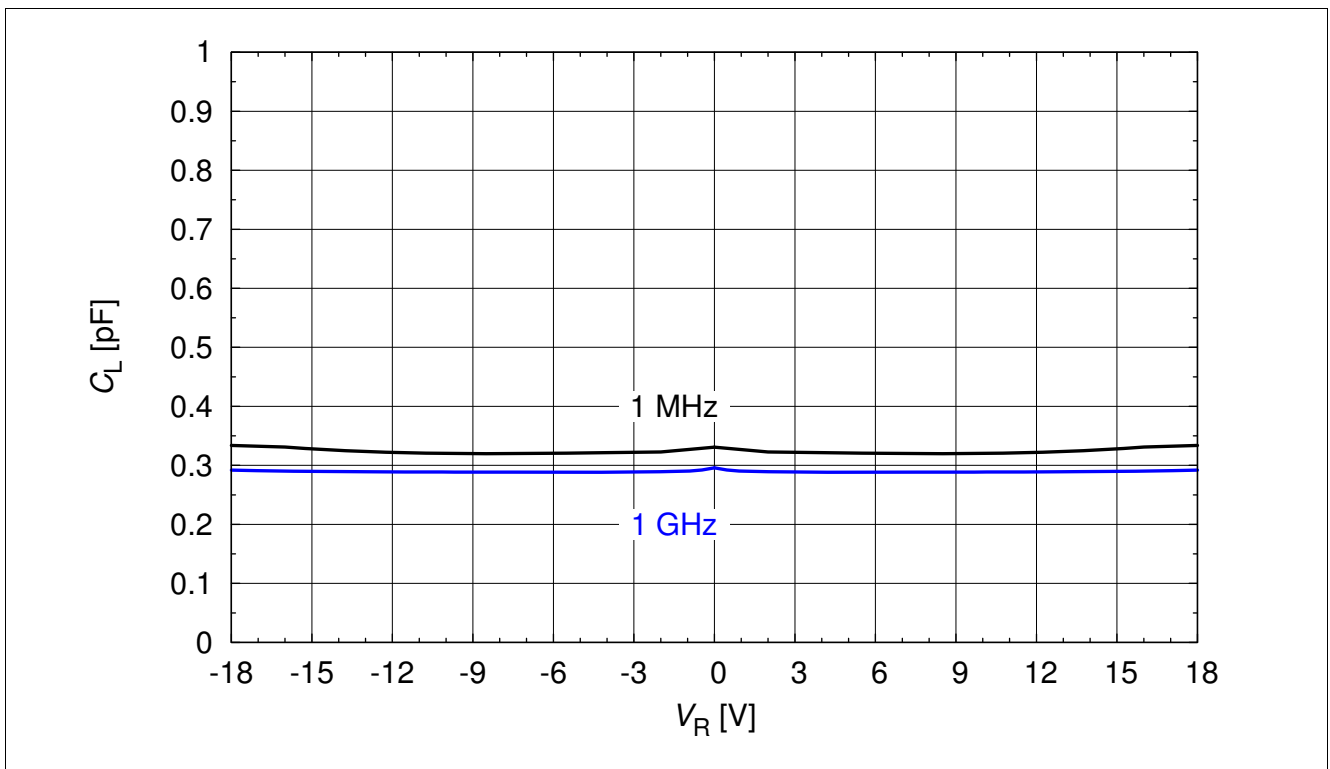

Figure 4-2 Line capacitance  $C_L = f(V_R), f = 1\text{ MHz}$

Typical Characteristics Diagrams

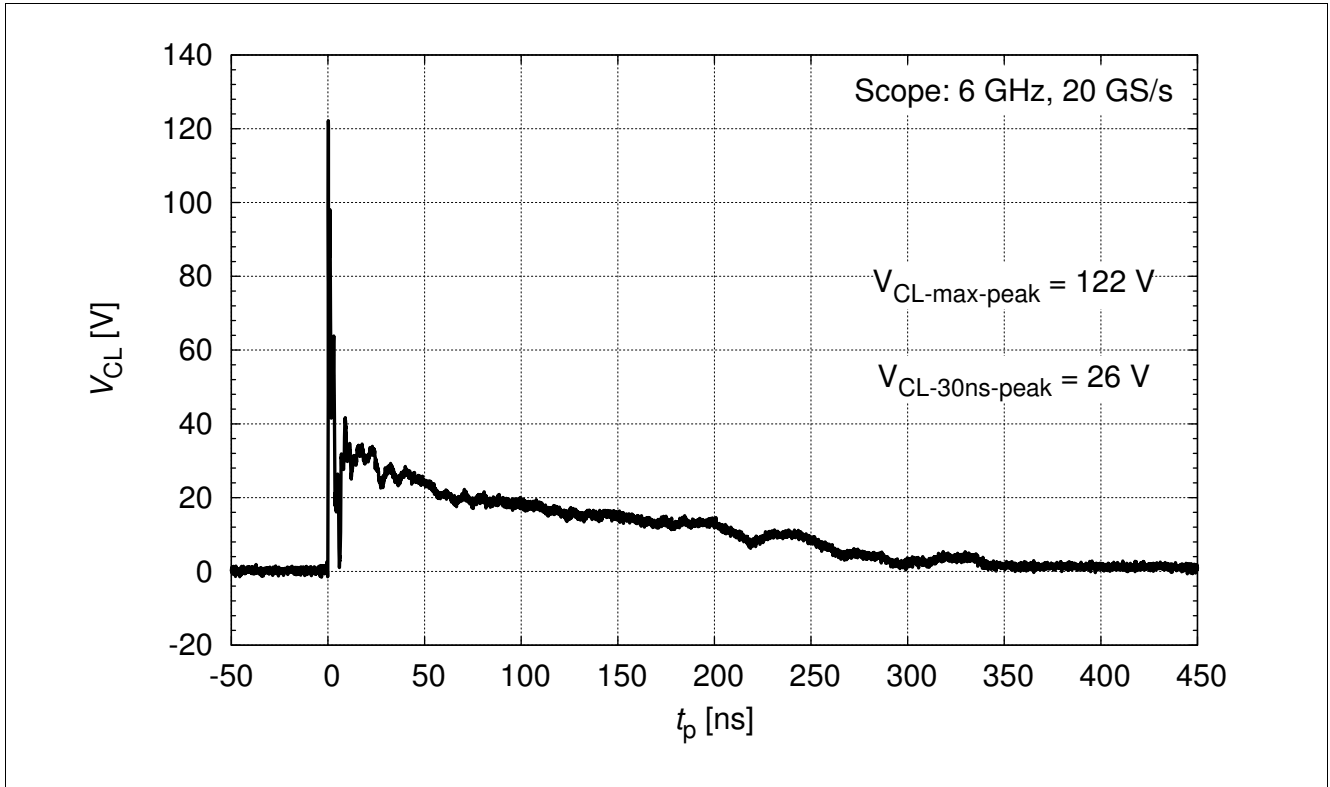

Figure 4-3 Clamping voltage (ESD):  $V_{CL} = f(t)$ , 8 kV positive pulse

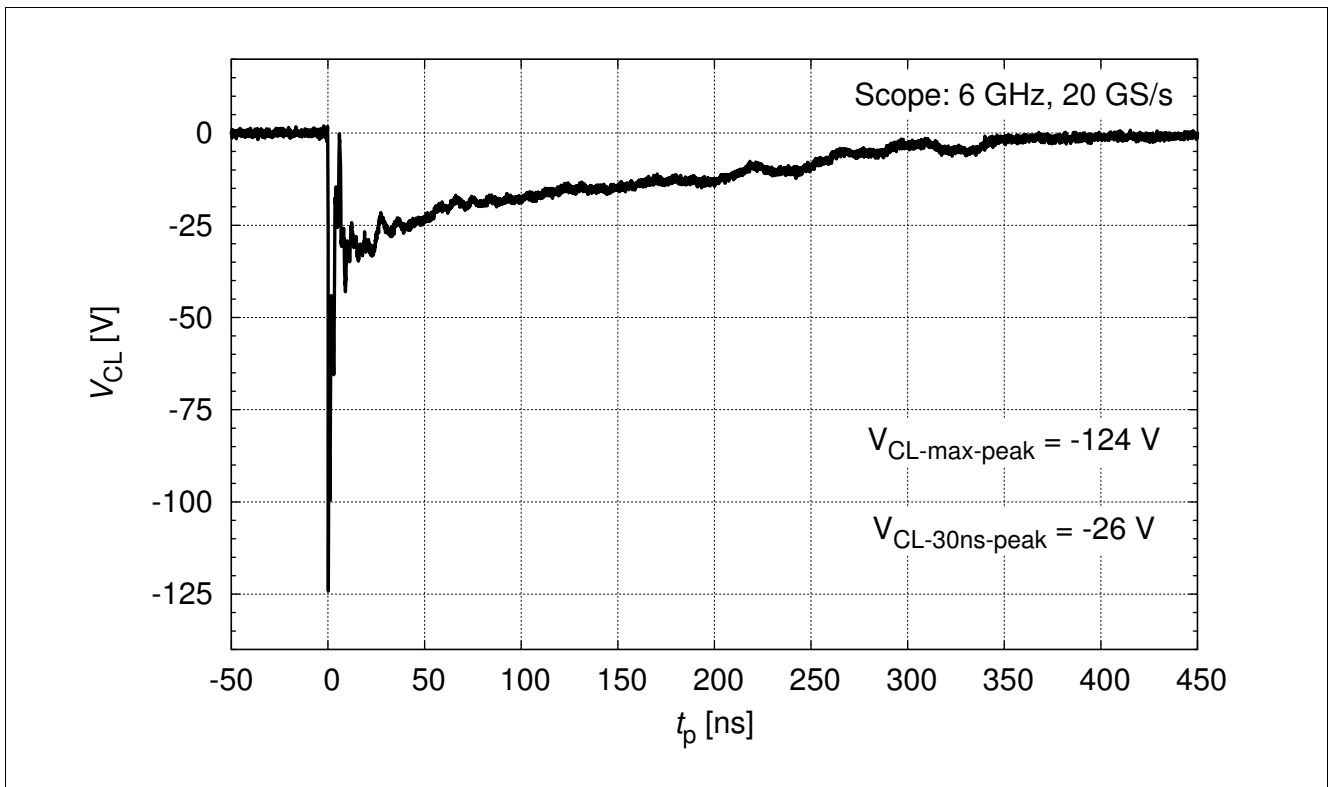

Figure 4-4 Clamping voltage (ESD):  $V_{CL} = f(t)$ , 8 kV negative pulse

Typical Characteristics Diagrams

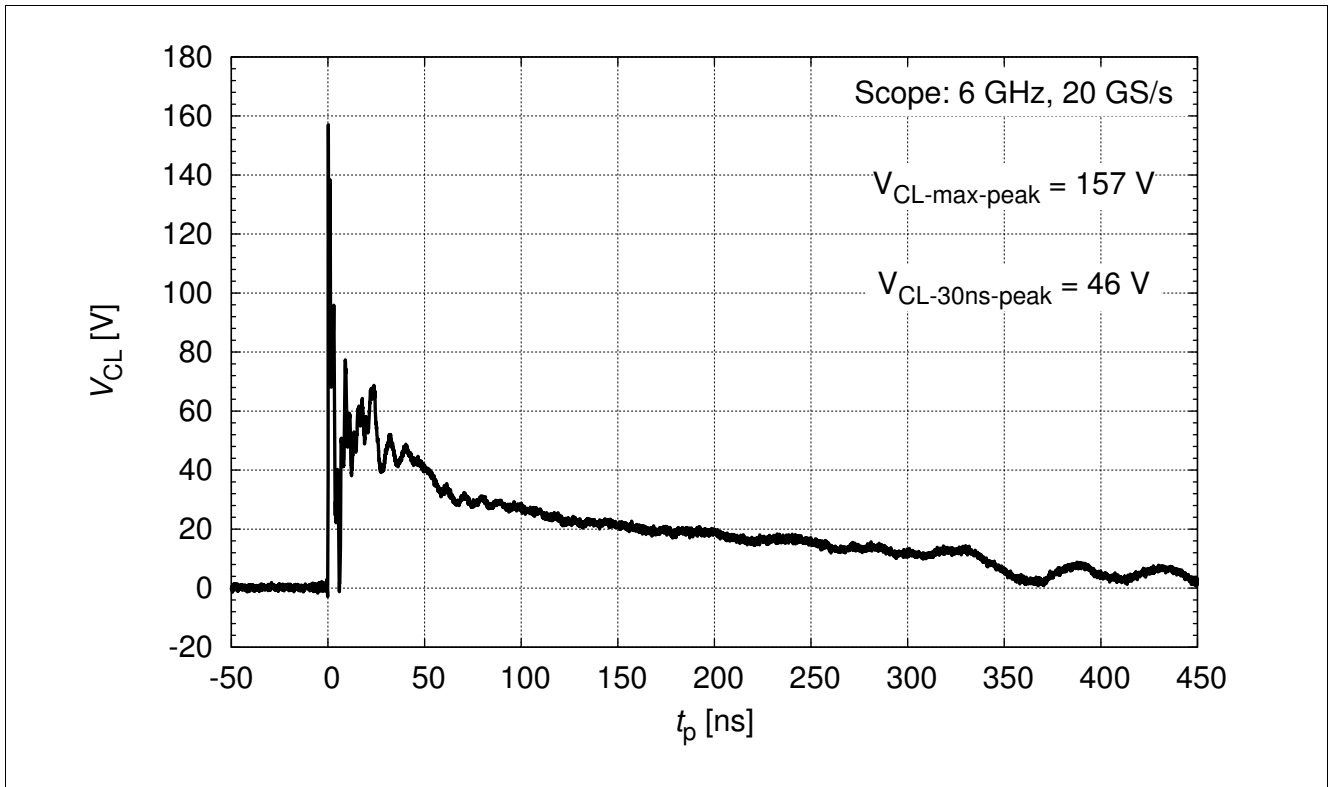

Figure 4-5 Clamping voltage (ESD):  $V_{CL} = f(t)$ , 15 kV positive pulse

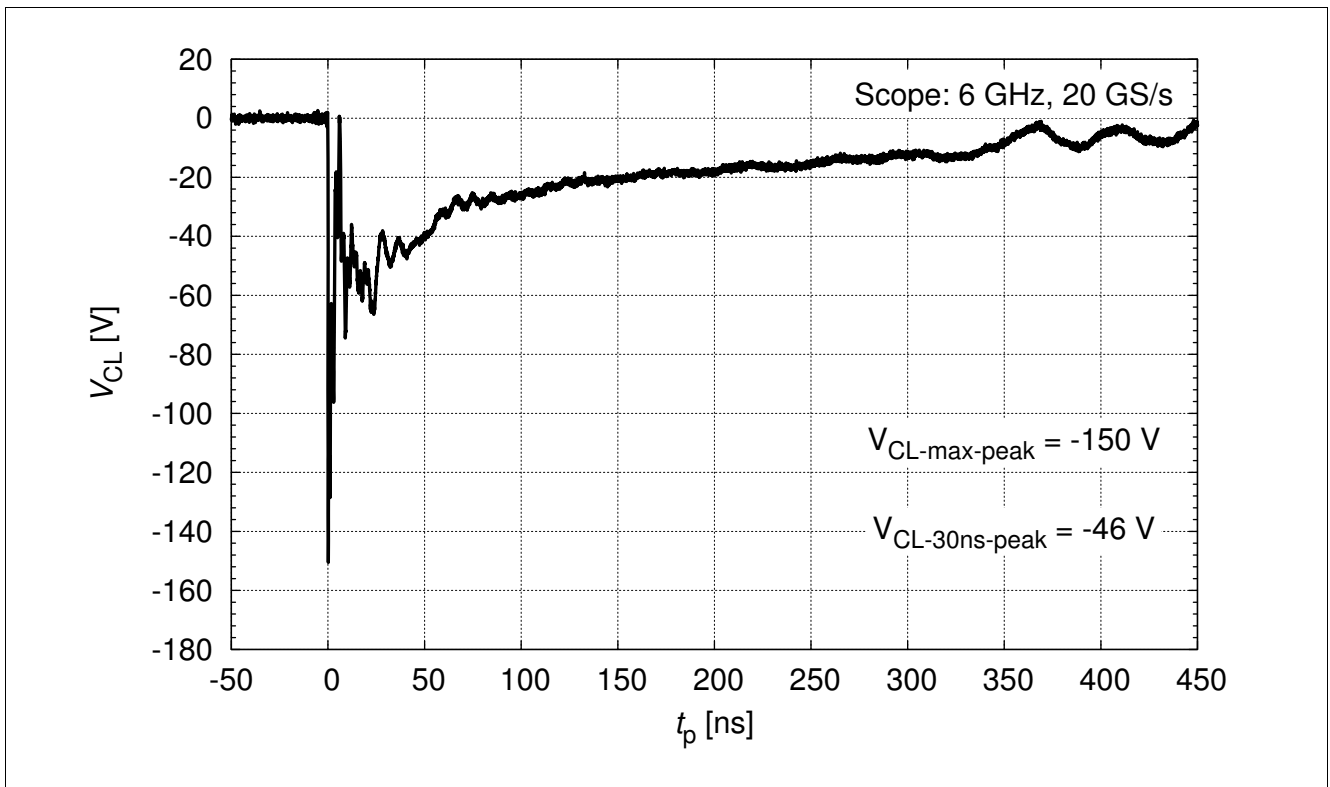

Figure 4-6 Clamping voltage (ESD):  $V_{CL} = f(t)$ , 15 kV negative pulse



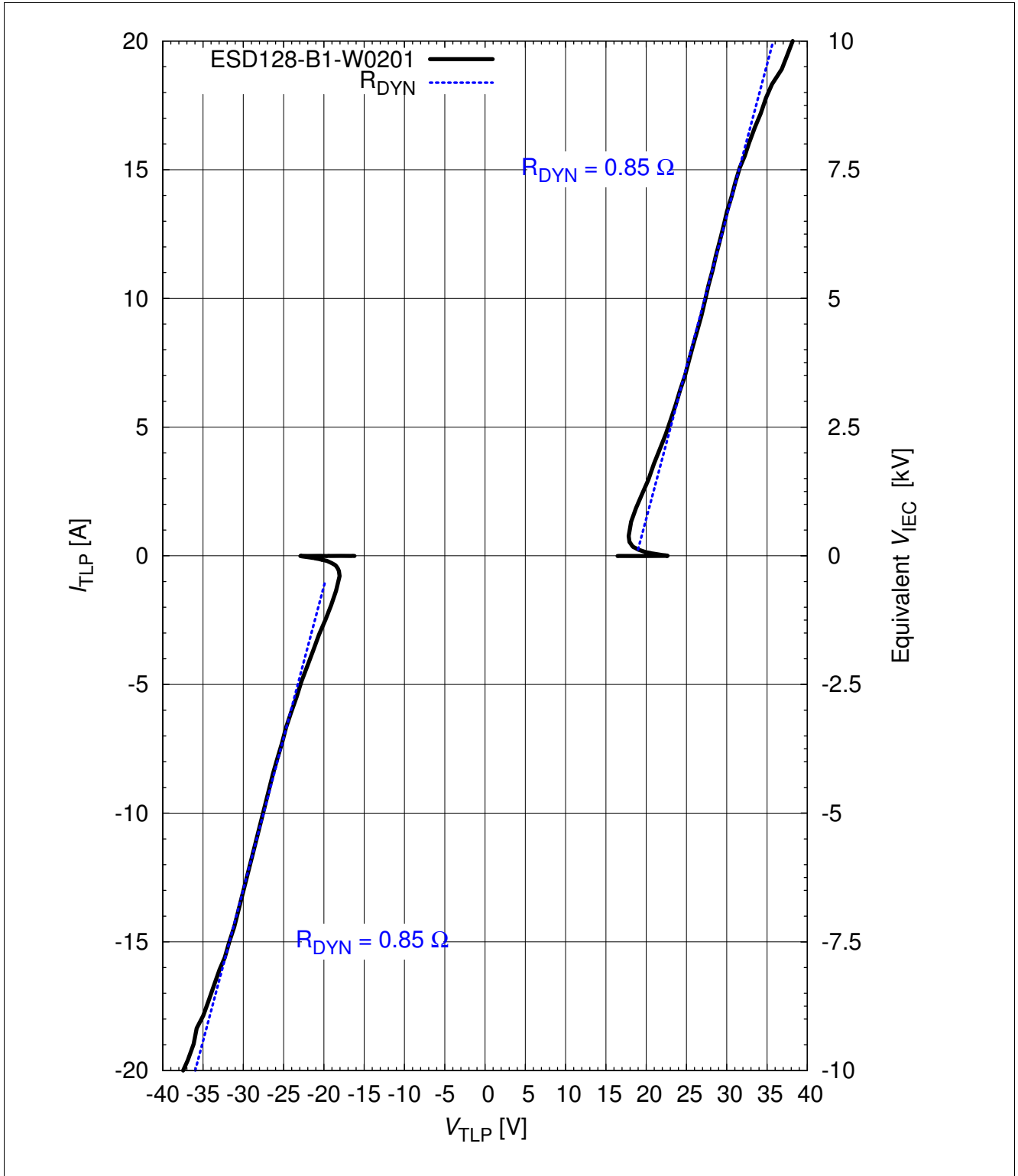

Figure 4-7 Clamping voltage (TLP):  $I_{TLP} = f(V_{TLP})$  [1]

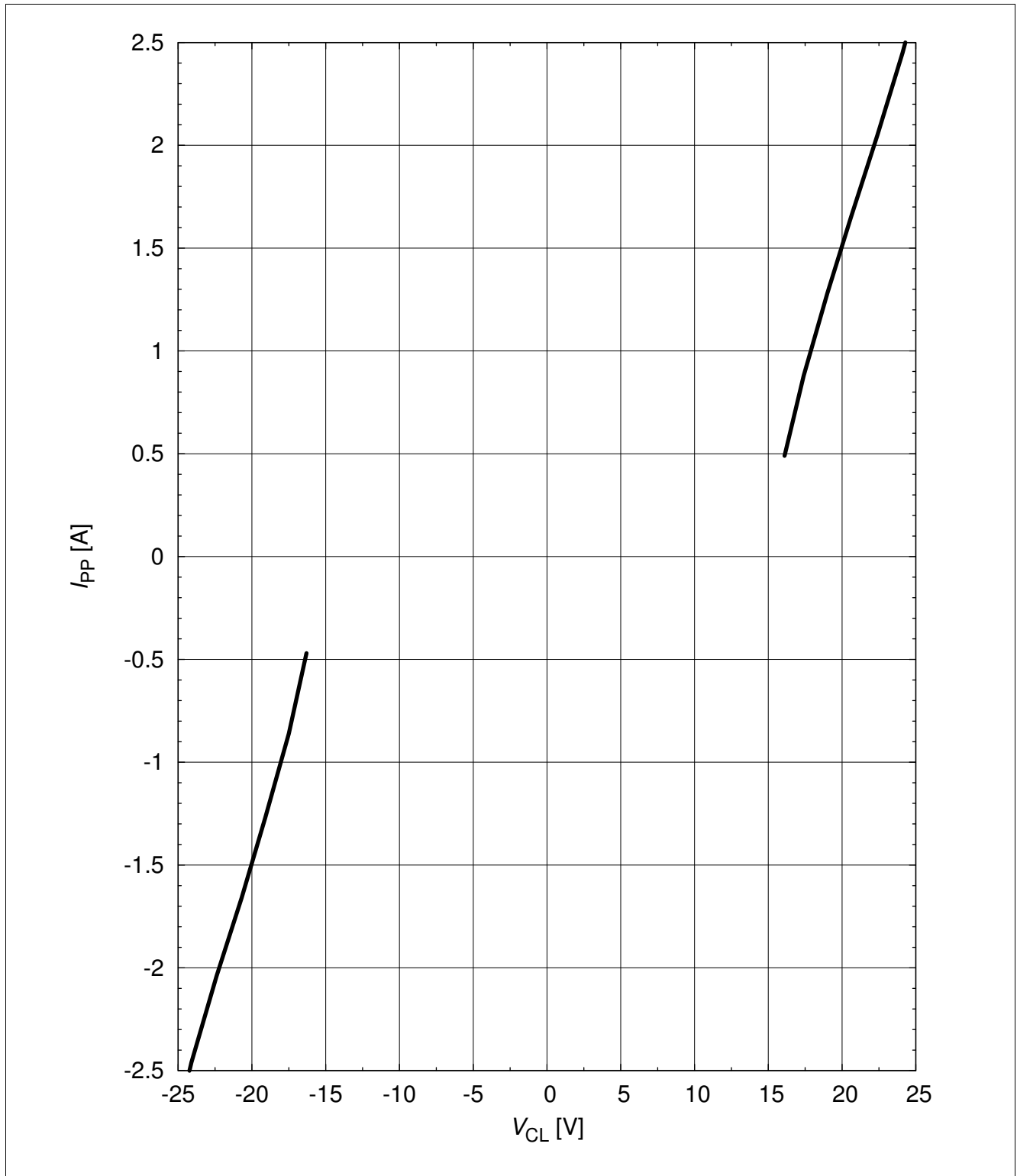

Figure 4-8 Clamping voltage(Surge):  $I_{PP} = f(V_{CL})$  [1]

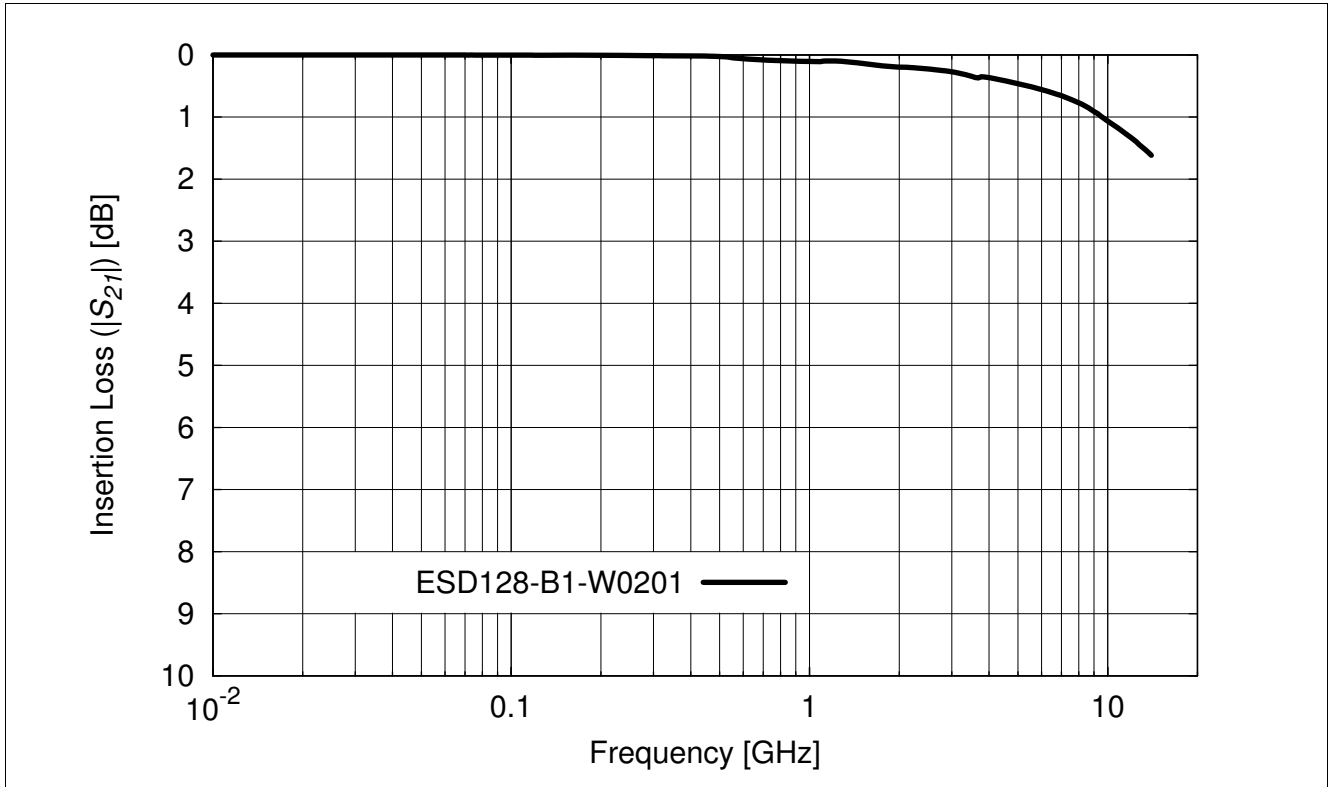

Figure 4-9 Insertion loss vs. frequency in a 50 Ω system

5 Application Information

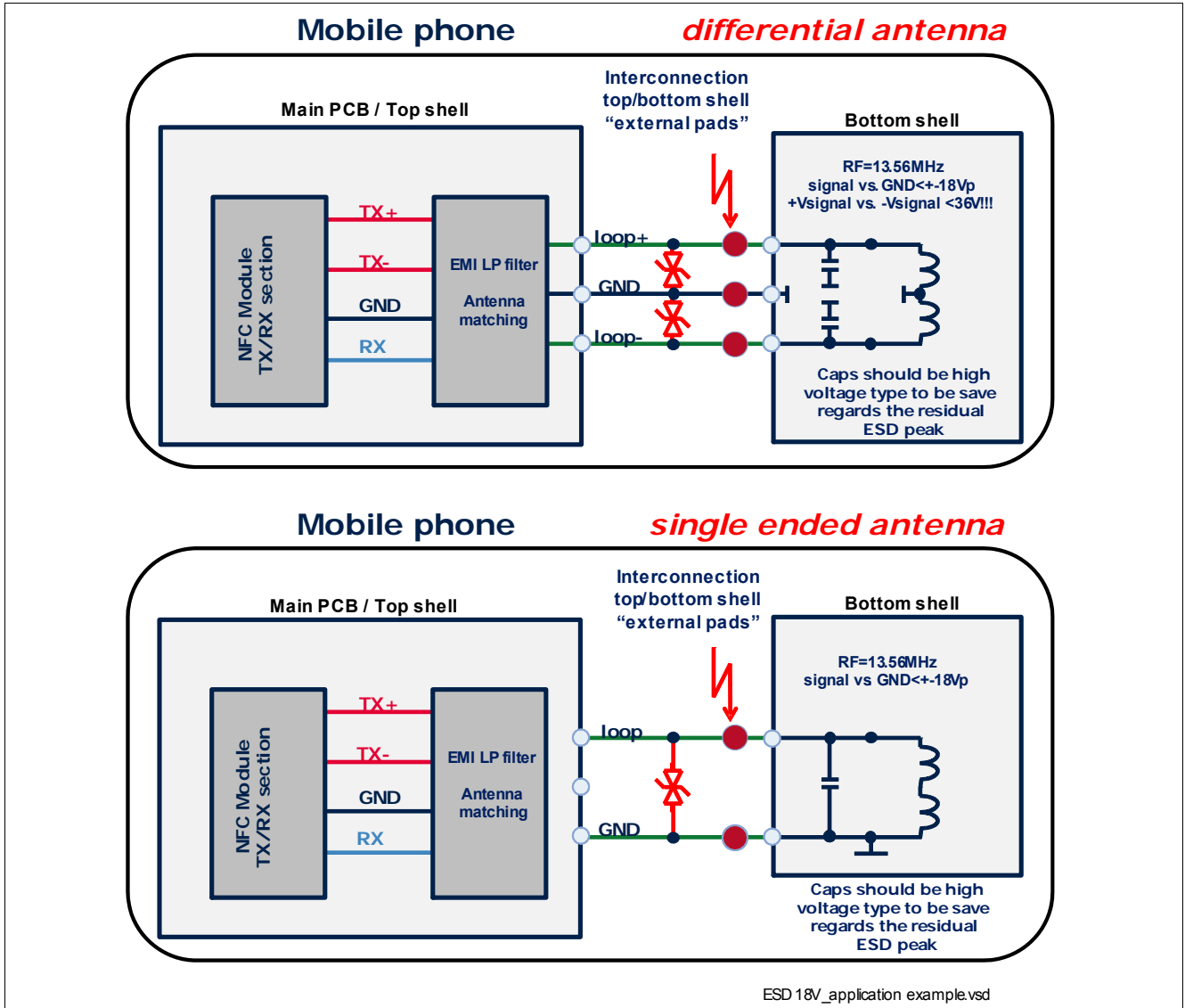

Figure 5-1 Bi-directional ESD / Transient protection for NFC Frontend [3]

## 6 Package Information

### 6.1 WLL-2-1

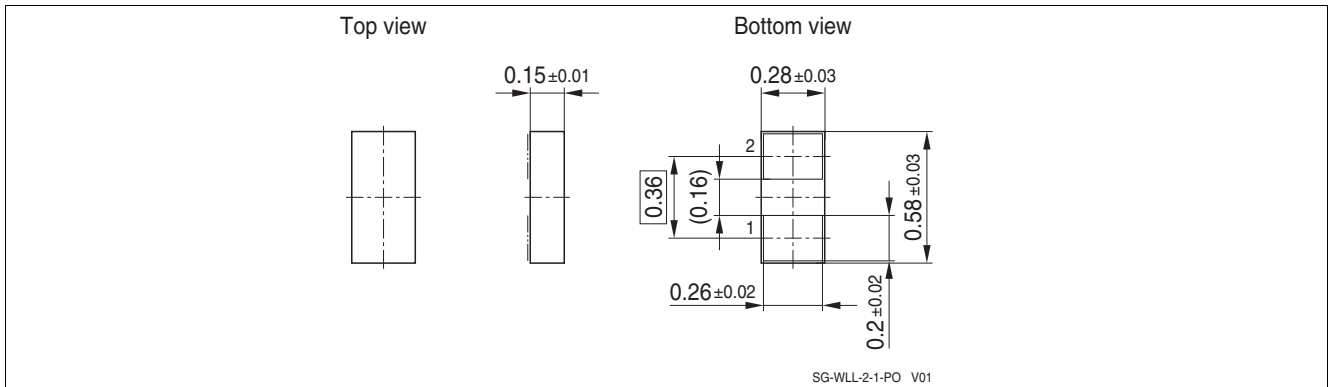

Figure 6-1 WLL-2-1 Package outline (dimension in mm)

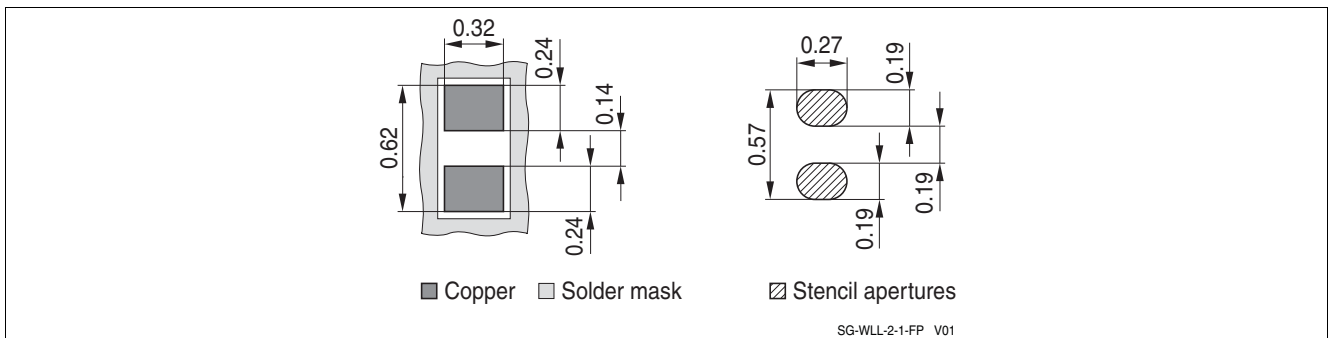

Figure 6-2 WLL-2-1 Footprint (see: Recommendation for Printed Circuit Board Assembly [2])

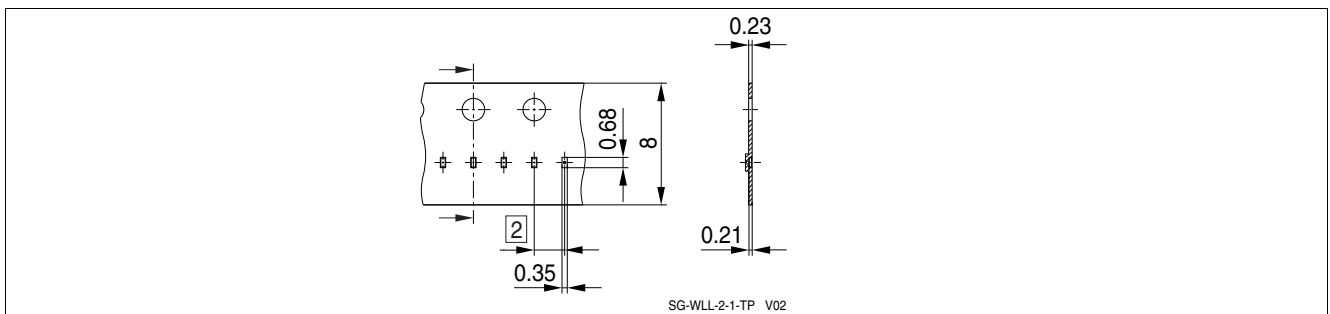

Figure 6-3 WLL-2-1 Packing (dimension in mm)

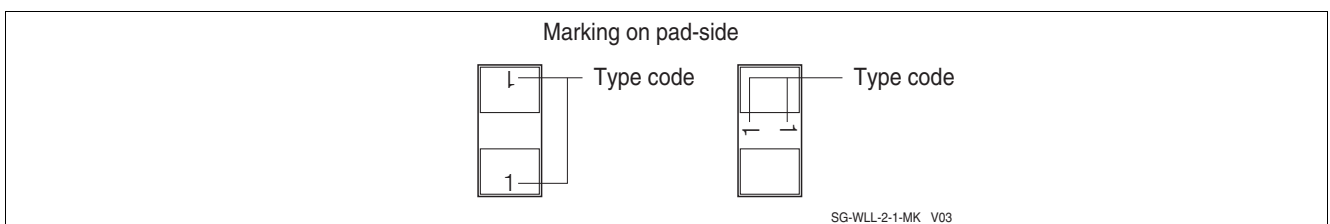

Figure 6-4 WLL-2-1 Marking example Table 1-1 "Part Information" on Page 3

**References**

- [1] Infineon AG - **Application Note AN210**: Effective ESD Protection design at System Level Using VF-TLP Characterization Methodology
- [2] Infineon AG - Recommendation for Printed Circuit Board Assembly of Infineon WLL Packages  
<http://www.infineon.com/dgdl/?fileId=db3a304344f7b4f9014503db540027c0>
- [3] Infineon AG - **Application Note AN244**: Tailored ESD Protection for the NFC Frontend

**Revision History: Rev. 1.2, 2015-09-29**

Page or Item	Subjects (major changes since previous revision)
<b>Revision 1.3, 2016-04-06</b>	
All	New layout

**Trademarks of Infineon Technologies AG**

AURIX™, BlueMoon™, C166™, CanPAK™, CIPOS™, CIPURSE™, COMNEON™, EconoPACK™, CoolMOS™, CoolSET™, CORECONTROL™, CROSSAVE™, DAVE™, EasyPIM™, EconoBRIDGE™, EconoDUAL™, EconoPIM™, EiceDRIVER™, eupec™, FCOS™, HITFET™, HybridPACK™, I<sup>2</sup>RF™, ISOFACE™, IsoPACK™, MIPAQ™, ModSTACK™, my-d™, NovalithIC™, OmniTune™, OptiMOS™, ORIGA™, PRIMARION™, PrimePACK™, PrimeSTACK™, PRO-SIL™, PROFET™, RASIC™, ReverSave™, SatRIC™, SIEGET™, SINDRION™, SIPMOS™, SMARTi™, SmartLEWIS™, SOLID FLASH™, TEMPFET™, thinQ!™, TRENCHSTOP™, TriCore™, X-GOLD™, X-PMU™, XMM™, XPOSYS™.

**Other Trademarks**

Advance Design System™ (ADS) of Agilent Technologies, AMBA™, ARM™, MULTI-ICE™, KEIL™, PRIMECELL™, REALVIEW™, THUMB™, μVision™ of ARM Limited, UK. AUTOSAR™ is licensed by AUTOSAR development partnership. Bluetooth™ of Bluetooth SIG Inc. CAT-iq™ of DECT Forum. COLOSSUS™, FirstGPS™ of Trimble Navigation Ltd. EMV™ of EMVCo, LLC (Visa Holdings Inc.). EPCOS™ of Epcos AG. FLEXGO™ of Microsoft Corporation. FlexRay™ is licensed by FlexRay Consortium. HYPERTERMINAL™ of Hilgraeve Incorporated. IEC™ of Commission Electrotechnique Internationale. IrDA™ of Infrared Data Association Corporation. ISO™ of INTERNATIONAL ORGANIZATION FOR STANDARDIZATION. MATLAB™ of MathWorks, Inc. MAXIM™ of Maxim Integrated Products, Inc. MICROTEC™, NUCLEUS™ of Mentor Graphics Corporation. Mifare™ of NXP. MIPI™ of MIPI Alliance, Inc. MIPS™ of MIPS Technologies, Inc., USA. muRata™ of MURATA MANUFACTURING CO., MICROWAVE OFFICE™ (MWO) of Applied Wave Research Inc., OmniVision™ of OmniVision Technologies, Inc. Openwave™ Openwave Systems Inc. RED HAT™ Red Hat, Inc. RFMD™ RF Micro Devices, Inc. SIRIUS™ of Sirius Satellite Radio Inc. SOLARIS™ of Sun Microsystems, Inc. SPANSION™ of Spansion LLC Ltd. Symbian™ of Symbian Software Limited. TAIYO YUDEN™ of Taiyo Yuden Co. TEAKLITE™ of CEVA, Inc. TEKTRONIX™ of Tektronix Inc. TOKO™ of TOKO KABUSHIKI KAISHA TA. UNIX™ of X/Open Company Limited. VERILOG™, PALLADIUM™ of Cadence Design Systems, Inc. VLYNQ™ of Texas Instruments Incorporated. VXWORKS™, WIND RIVER™ of WIND RIVER SYSTEMS, INC. ZETEX™ of Diodes Zetex Limited.

Last Trademarks Update 2010-10-26

[www.infineon.com](http://www.infineon.com)

Published by Infineon Technologies AG



# Mouser Electronics

Authorized Distributor

Click to View Pricing, Inventory, Delivery & Lifecycle Information:

[Infineon:](#)

[ESD128B1W0201E6327XTSA1](#)