

THIS DOCUMENT IS THE PROPERTY OF
KEYSTONE ELECTRONICS CORP. AND
SHALL NOT BE REPRODUCED, DISTRIBUTED
OR USED AS A BASIS FOR MANUFACTURE
WITHOUT PRIOR WRITTEN PERMISSION
FROM KEYSTONE ELECTRONICS CORP.

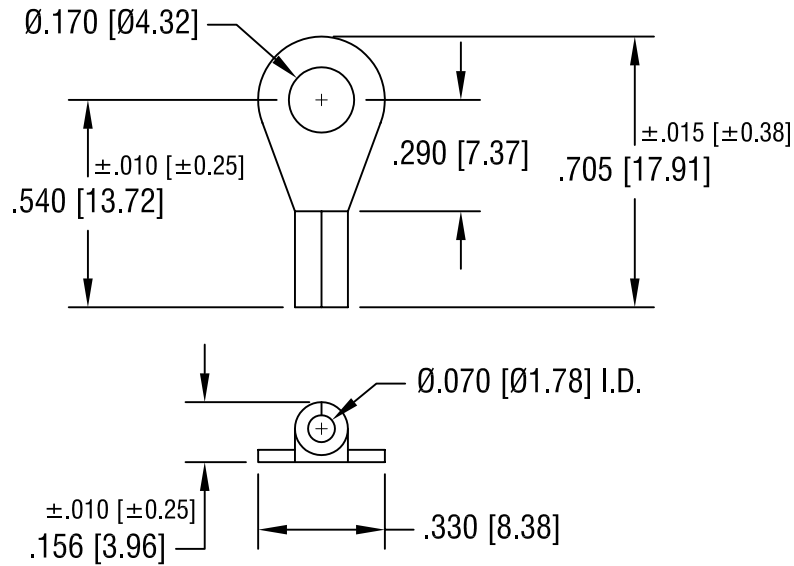

NOTE:

1. ACCOMMODATES WIRE RANGE 22/18 AWG

KEYSTONE ELECTRONICS CORP.			
ASTORIA, N.Y. 11105-2017			
PART NAME			
RING TONGUE TERMINAL			
MATERIAL			
.030 [0.76] TH'K COPPER			
FINISH		DRN BY	DATE
TIN PLATE		BOONE	10.17.07
		APP'D	SCALE
		LN	2X
TOLERANCES	INCH [MM]	CODE	DWG NO.
DECIMAL	$\pm .005$ [± 0.15]	C/M	8201
ANGULAR	$\pm 1^\circ$		
UNLESS OTHERWISE SPECIFIED			

DATE	DESCRIPTION	REV.

Mouser Electronics

Authorized Distributor

Click to View Pricing, Inventory, Delivery & Lifecycle Information:

[Keystone Electronics:](#)

[8201](#)