

3 Watts

- Regulated Single & Dual Outputs from 3.3 to 30VDC
- Wide 4:1 Input Range
- Input Range 4.5 to 18, 9 to 36, 18 to 75VDC
- Compact DIP8 Package
- 1.6kVDC Input/Output Isolation
- Efficiency to 84%
- Complies with EN55032
- Short-Circuit Protection
- Remote On/Off
- -40°C to +80°C Operating Temperature
- Full Power up to +70°C
- MTBF >820 Khrs (MIL-HDBK-217F, +25°C GB)
- 3 Year Warranty

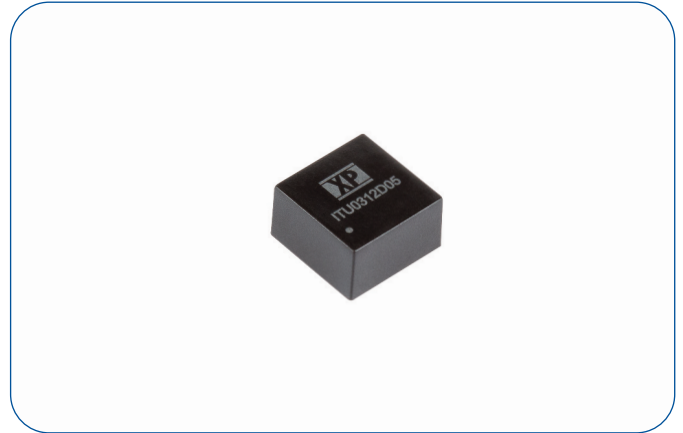

Dimensions:

ITU03: 0.55 x 0.55 x 0.32" (14.0 x 14.0 x 8.1mm)

The ITU series offers a compact 3W, cost effective DC-DC module with a wide range of input voltages and output voltages. Regulation to 1%, industrial temperature range with a robust encapsulated DIP8 construction, remote on/off and short circuit protection.

Models & Ratings

Input Voltage	Output Voltage	Output Current (Full Load)	Input Current ⁽¹⁾		Maximum Capacitive Load ⁽²⁾	Efficiency	Model Number
			No Load	Full Load			
12V (4.5-18V)	3.3V	700mA	30mA	257mA	3300µF	75%	ITU0312S3V3
	5.0V	600mA	45mA	309mA	1680µF	81%	ITU0312S05
	12.0V	250mA	55mA	301mA	470µF	83%	ITU0312S12
	15.0V	200mA	60mA	301mA	330µF	83%	ITU0312S15
	±5.0V	±300mA	30mA	313mA	±1000µF	80%	ITU0312D05
	±12.0V	±125mA	55mA	305mA	±220µF	82%	ITU0312D12
	±15.0V	±100mA	60mA	301mA	±220µF	83%	ITU0312D15
24V (9-36V)	3.3V	700mA	25mA	127mA	3300µF	76%	ITU0324S3V3
	5.0V	600mA	20mA	152mA	1680µF	82%	ITU0324S05
	12.0V	250mA	30mA	149mA	470µF	84%	ITU0324S12
	15.0V	200mA	35mA	149mA	330µF	84%	ITU0324S15
	±5.0V	±300mA	25mA	154mA	±1000µF	81%	ITU0324D05
	±12.0V	±125mA	30mA	151mA	±220µF	83%	ITU0324D12
	±15.0V	±100mA	35mA	149mA	±220µF	84%	ITU0324D15
48V (18-75V)	3.3V	700mA	10mA	65mA	3300µF	74%	ITU0348S3V3
	5.0V	600mA	10mA	77mA	1680µF	81%	ITU0348S05
	12.0V	250mA	15mA	77mA	470µF	81%	ITU0348S12
	15.0V	200mA	15mA	76mA	330µF	82%	ITU0348S15
	±5.0V	±300 mA	20mA	79mA	±1000µF	79%	ITU0348D05
	±12.0V	±125 mA	20mA	78mA	±220µF	80%	ITU0348D12
	±15.0V	±100 mA	25mA	78mA	±220µF	80%	ITU0348D15

Notes

1. Measurements taken at full load, minimal input voltage
2. Maximum capacitive load is per output
3. Standard tube quantity 30 pcs

Input

Characteristic	Minimum	Typical	Maximum	Units	Notes & Conditions
Input Voltage Range	4.5	12	18	VDC	ITU0312 series
	9	24	36		ITU0324 series
	18	48	75		ITU0348 series
Input Filter	Integral capacitor				
Input Reflected Ripple			20	mA pk-pk	Through 27µH inductor and 47µF capacitor
Input Surge			25	VDC for 100ms	12V models, ITU0312 series
			50		24V models, ITU0324 series
			100		48V models, ITU0348 series
Inhibit Mode Input Current		2.5		mA	Vin nominal

Output

Characteristic	Minimum	Typical	Maximum	Units	Notes & Conditions
Output Voltage	3.3		30	VDC	See Models and Ratings table
Initial Set Accuracy			±1	%	
Minimum Load	0			A	No minimum load required
Line Regulation			±0.2	%	
Load Regulation			±1	%	From 0 to 100% load
Cross Regulation			±5	%	On dual output models when one load is varied between 25% and 100% and other is fixed at 100%
Transient Response Deviation			±5	% deviation	Recovery time 500µs, 25% load step change
Ripple & Noise			150	mV pk-pk	Single Output. 20MHz bandwidth. Measured using 0.1µF ceramic capacitor and 10µF electrolytic capacitor
			100		Dual Output. 20MHz bandwidth. Measured using 0.1µF ceramic capacitor and 10µF electrolytic capacitor
Short Circuit Protection	Continuous, with auto recovery				
Maximum Capacitive Load					See Models and Ratings table
Temperature Coefficient			0.02	%/°C	
Remote On/Off	Output is on if Remote On/Off (pin 2) is open. Output turns off if 2-4mA is applied to Remote On/Off (pin 2).				

General

Characteristic	Minimum	Typical	Maximum	Units	Notes & Conditions
Efficiency		81		%	See Models and Ratings table
Isolation: Input to Output	1600			VDC	Functional
Switching Frequency		100		kHz	
Isolation Resistance	10 ⁹			Ω	
Isolation Capacitance			2000	pF	
Power Density			31	Win ³	
Mean Time Between Failure	820			Khrs	MIL-HDBK-217F, +25°C GB
Case Material	Non conductive black plastic				
Potting Material	Silicon (UL94V-0 rated)				
Pin Material	Brass solder-coated				
Solder Process	JEDEC J-STD 020D.1. 260°C max. 1.5mm from case 10s max.				
Weight		0.008 (3.6)		lb (g)	

Environmental

Characteristic	Minimum	Typical	Maximum	Units	Notes & Conditions
Operating Temperature	-40		+80	°C	See derating curve
Storage Temperature	-55		+125	°C	
Case Temperature			+100	°C	
Humidity			95	%RH	Non-condensing
Cooling	Natural convection				

EMC: Emissions

Phenomenon	Standard	Test Level	Notes & Conditions
Conducted	EN55032	Class A	External components required. See application notes.
Radiated	EN55032	Class A	

EMC: Immunity

Phenomenon	Standard	Test Level	Criteria	Notes & Conditions
ESD	EN61000-4-2	±8kV	A	Air Discharge
Radiated	EN61000-4-3	10V/M	A	
EFT/Burst	EN61000-4-4	±2kV	A	External input capacitor required 220µF/100V
Surge	EN61000-4-5	±2kV	A	External input capacitor required 220µF/100V
Conducted	EN61000-4-6	10Vrms	A	
Magnetic Fields	EN61000-4-8	100A/m	A	

Application Notes

Remote On/Off

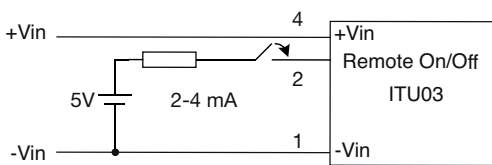

Model	C1	L
ITU0312	1210, 10µF, 35V	2.2µH
ITU0324	1210, 2.2µF, 100V	2.2µH
ITU0348	1210, 4.7µF, 35V	2.2µH

EMI Filter

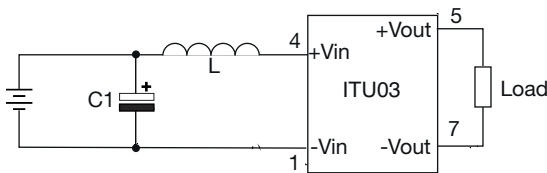

EFT & Surge

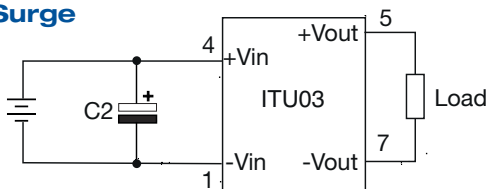

C2
220µF, 100V

Derating Curve

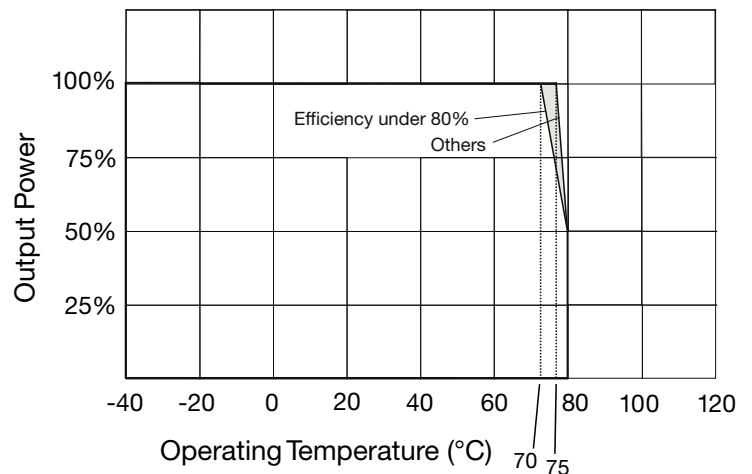

Mechanical Details

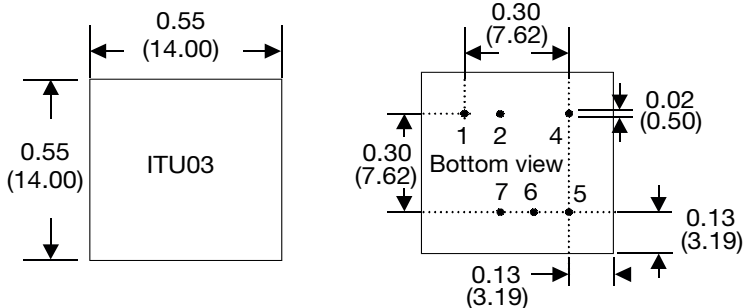

Notes

- All dimensions are in inches (mm)
- Weight: 0.008lbs (3.6g) approx.
- Pin diameter: 0.02±0.002 (0.5±0.05)
- Pin pitch tolerance: ±0.014 (±0.35)
- Case tolerance: ±0.02 (±0.5)

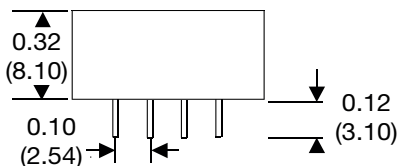

Pin	Pin Connections	
	Single	Dual
1	-V Input	-V Input
2	Remote On/Off	Remote On/Off
3	Not fitted	Not fitted
4	+V Input	+V Input
5	+V Output	+V Output
6	Not fitted	Common
7	-V Output	-V Output
8	Not fitted	Not fitted

Mouser Electronics

Authorized Distributor

Click to View Pricing, Inventory, Delivery & Lifecycle Information:

[XP Power:](#)

[ITU0312D05](#) [ITU0312D12](#) [ITU0312D15](#) [ITU0312S05](#) [ITU0312S12](#) [ITU0312S3V3](#) [ITU0324D05](#) [ITU0324D12](#)
[ITU0324D15](#) [ITU0324S05](#) [ITU0324S12](#) [ITU0324S3V3](#) [ITU0348D12](#) [ITU0348D15](#) [ITU0348S05](#) [ITU0348S12](#)
[ITU0348S15](#)