

# TIP41G, TIP41AG, TIP41BG, TIP41CG (NPN), TIP42G, TIP42AG, TIP42BG, TIP42CG (PNP)

## Complementary Silicon Plastic Power Transistors

Designed for use in general purpose amplifier and switching applications.

### Features

- Epoxy Meets UL 94 V-0 @ 0.125 in
- These Devices are Pb-Free and are RoHS Compliant\*

### MAXIMUM RATINGS

Rating	Symbol	Value	Unit
Collector-Emitter Voltage TIP41G, TIP42G TIP41AG, TIP42AG TIP41BG, TIP42BG TIP41CG, TIP42CG	$V_{CEO}$	40 60 80 100	Vdc
Collector-Base Voltage TIP41G, TIP42G TIP41AG, TIP42AG TIP41BG, TIP42BG TIP41CG, TIP42CG	$V_{CB}$	40 60 80 100	Vdc
Emitter-Base Voltage	$V_{EB}$	5.0	Vdc
Collector Current - Continuous	$I_C$	6.0	Adc
Collector Current - Peak	$I_{CM}$	10	Adc
Base Current	$I_B$	2.0	Adc
Total Power Dissipation @ $T_C = 25^\circ\text{C}$ Derate above $25^\circ\text{C}$	$P_D$	65 0.52	W W/ $^\circ\text{C}$
Total Power Dissipation @ $T_A = 25^\circ\text{C}$ Derate above $25^\circ\text{C}$	$P_D$	2.0 0.016	W W/ $^\circ\text{C}$
Unclamped Inductive Load Energy (Note 1)	E	62.5	mJ
Operating and Storage Junction, Temperature Range	$T_J, T_{stg}$	-65 to +150	$^\circ\text{C}$
ESD - Human Body Model	HBM	3B	V
ESD - Machine Model	MM	C	V

Stresses exceeding those listed in the Maximum Ratings table may damage the device. If any of these limits are exceeded, device functionality should not be assumed, damage may occur and reliability may be affected.

1.  $I_C = 2.5\text{ A}$ ,  $L = 20\text{ mH}$ , P.R.F. = 10 Hz,  $V_{CC} = 10\text{ V}$ ,  $R_{BE} = 100\ \Omega$ .

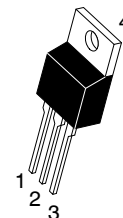
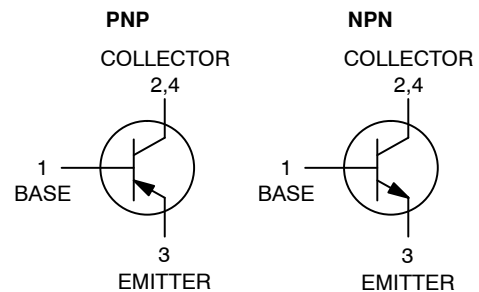
\*For additional information on our Pb-Free strategy and soldering details, please download the ON Semiconductor Soldering and Mounting Techniques Reference Manual, SOLDERRM/D.



ON Semiconductor®

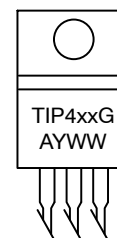
[www.onsemi.com](http://www.onsemi.com)

## 6 AMPERE COMPLEMENTARY SILICON POWER TRANSISTORS 40-60-80-100 VOLTS, 65 WATTS



TO-220  
CASE 221A  
STYLE 1

### MARKING DIAGRAM



TIP4xx = Device Code  
 xx = 1, 1A, 1B, 1C  
       2, 2A, 2B, 2C  
 A = Assembly Location  
 Y = Year  
 WW = Work Week  
 G = Pb-Free Package

### ORDERING INFORMATION

See detailed ordering and shipping information on page 6 of this data sheet.

# TIP41G, TIP41AG, TIP41BG, TIP41CG (NPN), TIP42G, TIP42AG, TIP42BG, TIP42CG (PNP)

## THERMAL CHARACTERISTICS

Characteristic	Symbol	Max	Unit
Thermal Resistance, Junction-to-Case	$R_{\theta JC}$	1.67	$^{\circ}C/W$
Thermal Resistance, Junction-to-Ambient	$R_{\theta JA}$	57	$^{\circ}C/W$

## ELECTRICAL CHARACTERISTICS ( $T_C = 25^{\circ}C$ unless otherwise noted)

Characteristic	Symbol	Min	Max	Unit
----------------	--------	-----	-----	------

### OFF CHARACTERISTICS

Collector-Emitter Sustaining Voltage (Note 2) ( $I_C = 30$ mAdc, $I_B = 0$ ) TIP41G, TIP42G TIP41AG, TIP42AG TIP41BG, TIP42BG TIP41CG, TIP42CG	$V_{CE(sus)}$	40 60 80 100	- - - -	Vdc
Collector Cutoff Current ( $V_{CE} = 30$ Vdc, $I_B = 0$ ) TIP41G, TIP41AG, TIP42G, TIP42AG ( $V_{CE} = 60$ Vdc, $I_B = 0$ ) TIP41BG, TIP41CG, TIP42BG, TIP42CG	$I_{CEO}$	- -	0.7 0.7	mAdc
Collector Cutoff Current ( $V_{CE} = 40$ Vdc, $V_{EB} = 0$ ) TIP41G, TIP42G ( $V_{CE} = 60$ Vdc, $V_{EB} = 0$ ) TIP41AG, TIP42AG ( $V_{CE} = 80$ Vdc, $V_{EB} = 0$ ) TIP41BG, TIP42BG ( $V_{CE} = 100$ Vdc, $V_{EB} = 0$ ) TIP41CG, TIP42CG	$I_{CES}$	- - - -	400 400 400 400	$\mu$ Adc
Emitter Cutoff Current ( $V_{BE} = 5.0$ Vdc, $I_C = 0$ )	$I_{EBO}$	-	1.0	mAdc

### ON CHARACTERISTICS (Note 2)

DC Current Gain ( $I_C = 0.3$ Adc, $V_{CE} = 4.0$ Vdc) ( $I_C = 3.0$ Adc, $V_{CE} = 4.0$ Vdc)	$h_{FE}$	30 15	- 75	-
Collector-Emitter Saturation Voltage ( $I_C = 6.0$ Adc, $I_B = 600$ mAdc)	$V_{CE(sat)}$	-	1.5	Vdc
Base-Emitter On Voltage ( $I_C = 6.0$ Adc, $V_{CE} = 4.0$ Vdc)	$V_{BE(on)}$	-	2.0	Vdc

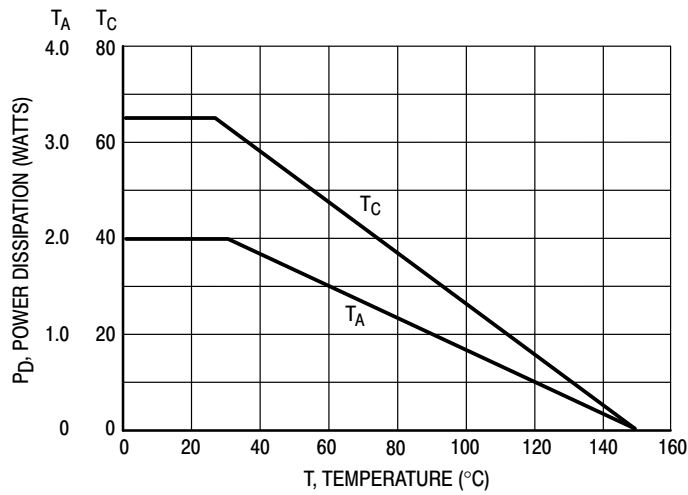
### DYNAMIC CHARACTERISTICS

Current-Gain - Bandwidth Product ( $I_C = 500$ mAdc, $V_{CE} = 10$ Vdc, $f_{test} = 1.0$ MHz)	$f_T$	3.0	-	MHz
Small-Signal Current Gain ( $I_C = 0.5$ Adc, $V_{CE} = 10$ Vdc, $f = 1.0$ kHz)	$h_{fe}$	20	-	-

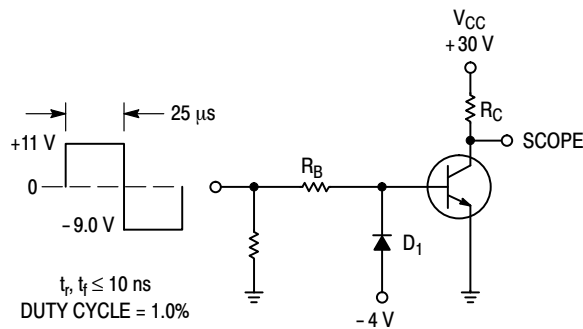
Product parametric performance is indicated in the Electrical Characteristics for the listed test conditions, unless otherwise noted. Product performance may not be indicated by the Electrical Characteristics if operated under different conditions.

2. Pulse Test: Pulse Width  $\leq 300$   $\mu$ s, Duty Cycle  $\leq 2.0\%$ .

**TIP41G, TIP41AG, TIP41BG, TIP41CG (NPN), TIP42G, TIP42AG, TIP42BG, TIP42CG (PNP)**

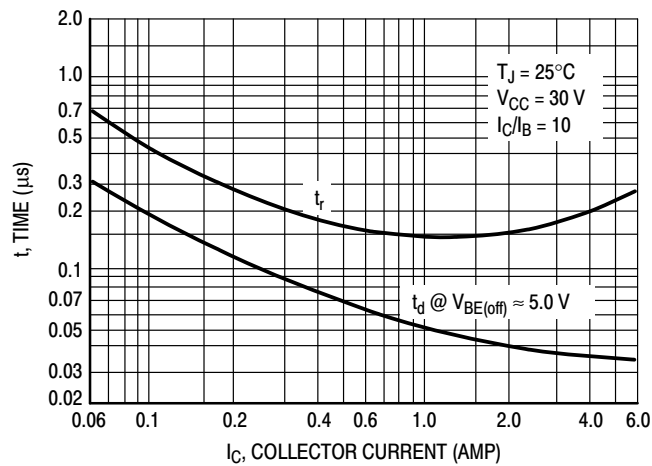


**Figure 1. Power Derating**



$R_B$  and  $R_C$  VARIED TO OBTAIN DESIRED CURRENT LEVELS  
 $D_1$  MUST BE FAST RECOVERY TYPE, e.g.:  
 1N5825 USED ABOVE  $I_B \approx 100\text{ mA}$   
 MSD6100 USED BELOW  $I_B \approx 100\text{ mA}$

**Figure 2. Switching Time Test Circuit**



**Figure 3. Turn-On Time**

TIP41G, TIP41AG, TIP41BG, TIP41CG (NPN), TIP42G, TIP42AG, TIP42BG, TIP42CG (PNP)

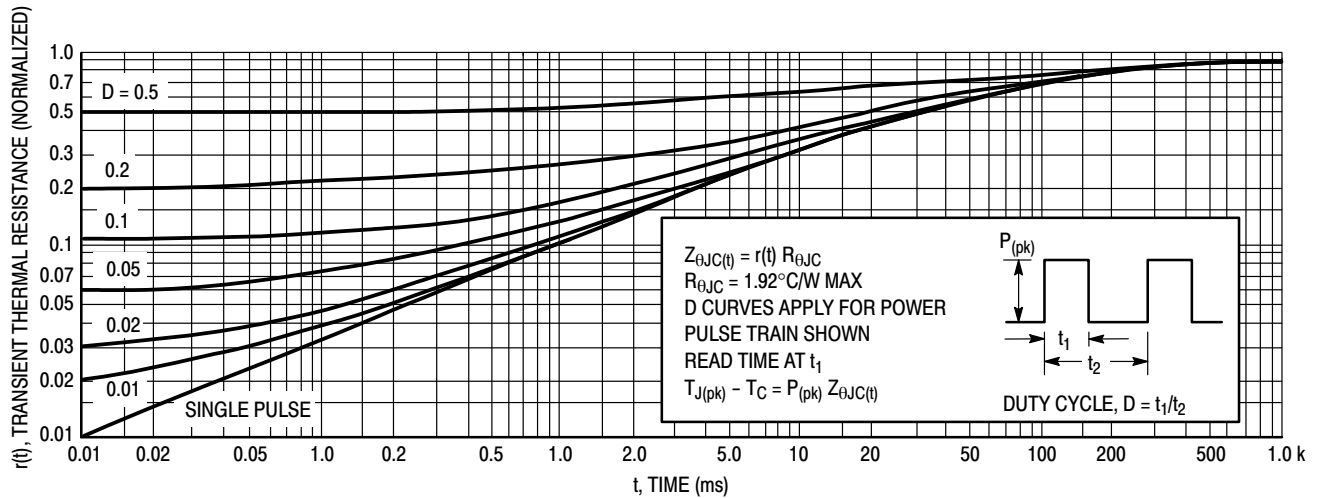


Figure 4. Thermal Response

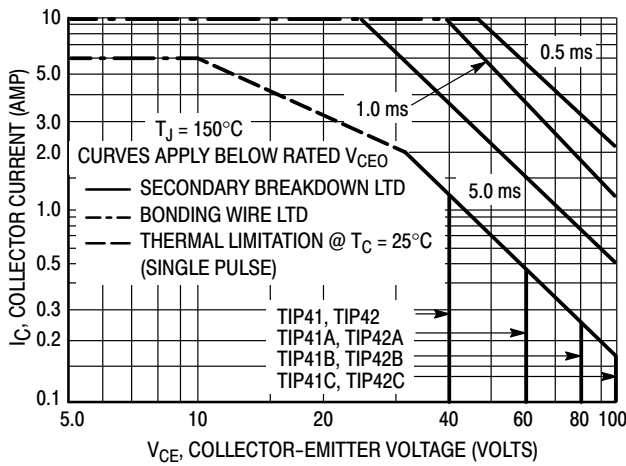


Figure 5. Active-Region Safe Operating Area

There are two limitations on the power handling ability of a transistor: average junction temperature and second breakdown. Safe operating area curves indicate  $I_C - V_{CE}$  limits of the transistor that must be observed for reliable operation; i.e., the transistor must not be subjected to greater dissipation than the curves indicate.

The data of Figure 5 is based on  $T_{J(pk)} = 150^{\circ}\text{C}$ ;  $T_C$  is variable depending on conditions. Second breakdown pulse limits are valid for duty cycles to 10% provided  $T_{J(pk)} \leq 150^{\circ}\text{C}$ .  $T_{J(pk)}$  may be calculated from the data in Figure 4. At high case temperatures, thermal limitations will reduce the power that can be handled to values less than the limitations imposed by second breakdown.

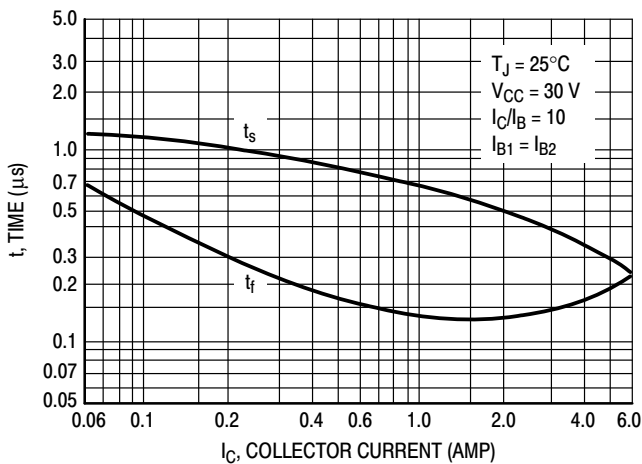


Figure 6. Turn-Off Time

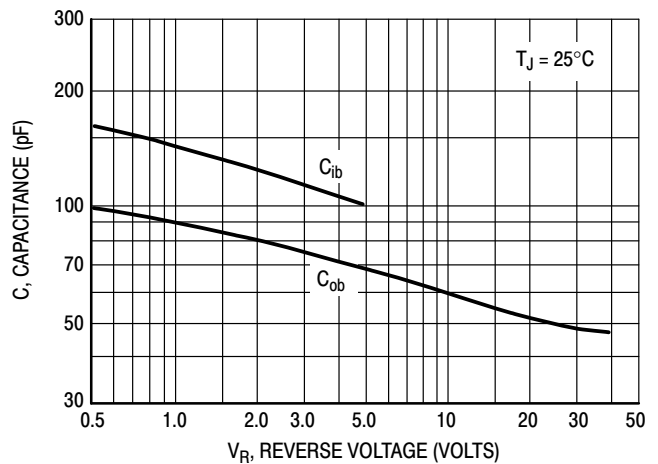


Figure 7. Capacitance

TIP41G, TIP41AG, TIP41BG, TIP41CG (NPN), TIP42G, TIP42AG, TIP42BG, TIP42CG (PNP)

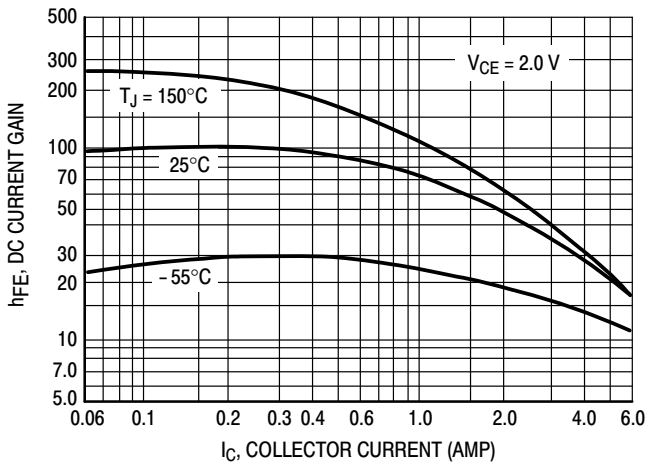


Figure 8. DC Current Gain

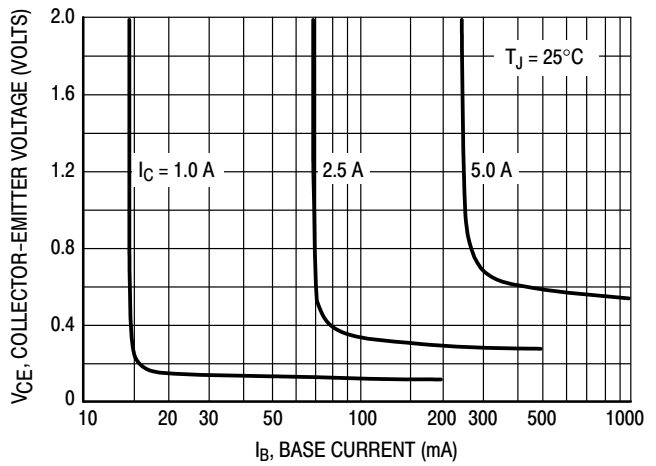


Figure 9. Collector Saturation Region

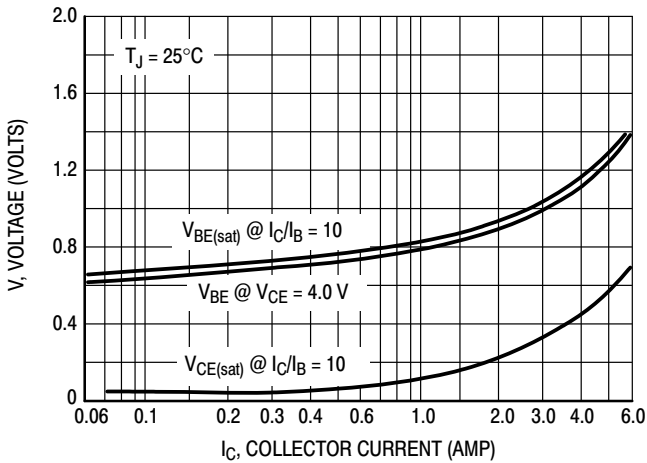


Figure 10. "On" Voltages

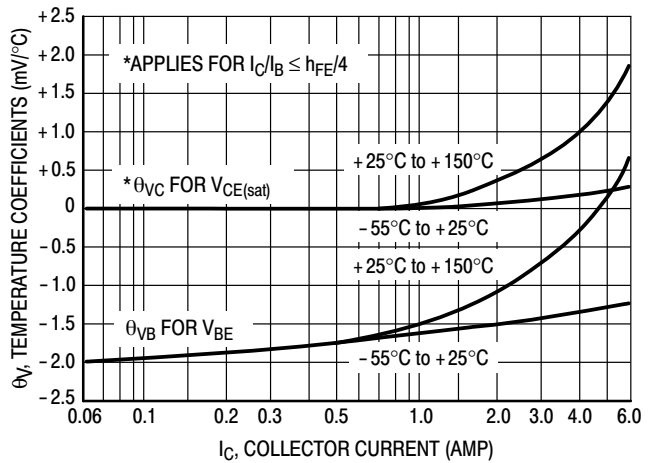


Figure 11. Temperature Coefficients

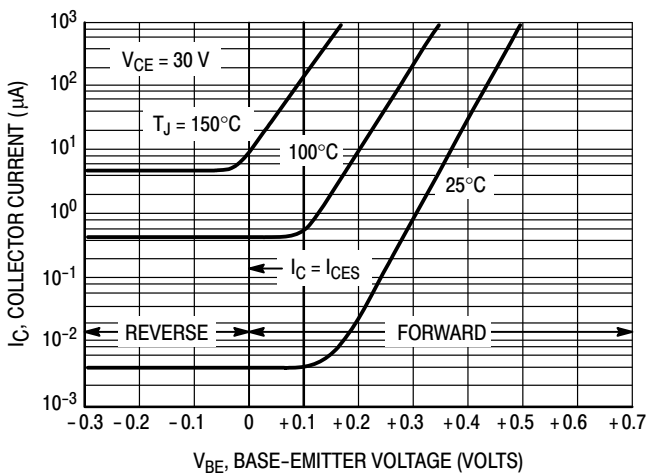


Figure 12. Collector Cut-Off Region

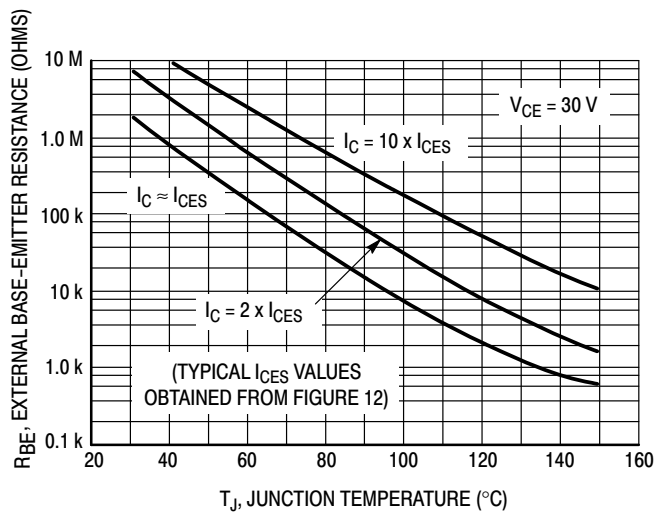


Figure 13. Effects of Base-Emitter Resistance

**TIP41G, TIP41AG, TIP41BG, TIP41CG (NPN), TIP42G, TIP42AG, TIP42BG,  
TIP42CG (PNP)**

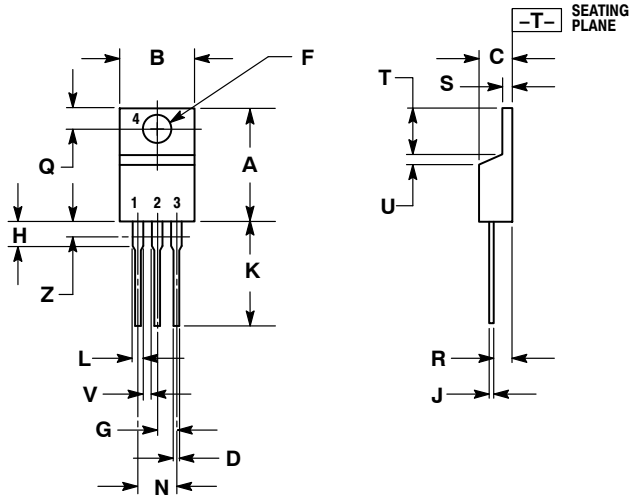
**ORDERING INFORMATION**

<b>Device</b>	<b>Package</b>	<b>Shipping</b>
TIP41G	TO-220 (Pb-Free)	50 Units / Rail
TIP41AG	TO-220 (Pb-Free)	50 Units / Rail
TIP41BG	TO-220 (Pb-Free)	50 Units / Rail
TIP41CG	TO-220 (Pb-Free)	50 Units / Rail
TIP42G	TO-220 (Pb-Free)	50 Units / Rail
TIP42AG	TO-220 (Pb-Free)	50 Units / Rail
TIP42BG	TO-220 (Pb-Free)	50 Units / Rail
TIP42CG	TO-220 (Pb-Free)	50 Units / Rail

# TIP41G, TIP41AG, TIP41BG, TIP41CG (NPN), TIP42G, TIP42AG, TIP42BG, TIP42CG (PNP)

## PACKAGE DIMENSIONS

TO-220  
CASE 221A-09  
ISSUE AH



NOTES:

1. DIMENSIONING AND TOLERANCING PER ANSI Y14.5M, 1982.
2. CONTROLLING DIMENSION: INCH.
3. DIMENSION Z DEFINES A ZONE WHERE ALL BODY AND LEAD IRREGULARITIES ARE ALLOWED.

DIM	INCHES		MILLIMETERS	
	MIN	MAX	MIN	MAX
A	0.570	0.620	14.48	15.75
B	0.380	0.415	9.66	10.53
C	0.160	0.190	4.07	4.83
D	0.025	0.038	0.64	0.96
F	0.142	0.161	3.61	4.09
G	0.095	0.105	2.42	2.66
H	0.110	0.161	2.80	4.10
J	0.014	0.024	0.36	0.61
K	0.500	0.562	12.70	14.27
L	0.045	0.060	1.15	1.52
N	0.190	0.210	4.83	5.33
Q	0.100	0.120	2.54	3.04
R	0.080	0.110	2.04	2.79
S	0.045	0.055	1.15	1.39
T	0.235	0.255	5.97	6.47
U	0.000	0.050	0.00	1.27
V	0.045	---	1.15	---
Z	---	0.080	---	2.04

STYLE 1:

1. BASE
2. COLLECTOR
3. EMITTER
4. COLLECTOR

ON Semiconductor and the are registered trademarks of Semiconductor Components Industries, LLC (SCILLC) or its subsidiaries in the United States and/or other countries. SCILLC owns the rights to a number of patents, trademarks, copyrights, trade secrets, and other intellectual property. A listing of SCILLC's product/patent coverage may be accessed at [www.onsemi.com/site/pdf/Patent-Marking.pdf](http://www.onsemi.com/site/pdf/Patent-Marking.pdf). SCILLC reserves the right to make changes without further notice to any products herein. SCILLC makes no warranty, representation or guarantee regarding the suitability of its products for any particular purpose, nor does SCILLC assume any liability arising out of the application or use of any product or circuit, and specifically disclaims any and all liability, including without limitation special, consequential or incidental damages. "Typical" parameters which may be provided in SCILLC data sheets and/or specifications can and do vary in different applications and actual performance may vary over time. All operating parameters, including "Typicals" must be validated for each customer application by customer's technical experts. SCILLC does not convey any license under its patent rights nor the rights of others. SCILLC products are not designed, intended, or authorized for use as components in systems intended for surgical implant into the body, or other applications intended to support or sustain life, or for any other application in which the failure of the SCILLC product could create a situation where personal injury or death may occur. Should Buyer purchase or use SCILLC products for any such unintended or unauthorized application, Buyer shall indemnify and hold SCILLC and its officers, employees, subsidiaries, affiliates, and distributors harmless against all claims, costs, damages, and expenses, and reasonable attorney fees arising out of, directly or indirectly, any claim of personal injury or death associated with such unintended or unauthorized use, even if such claim alleges that SCILLC was negligent regarding the design or manufacture of the part. SCILLC is an Equal Opportunity/Affirmative Action Employer. This literature is subject to all applicable copyright laws and is not for resale in any manner.

### PUBLICATION ORDERING INFORMATION

**LITERATURE FULFILLMENT:**

Literature Distribution Center for ON Semiconductor  
P.O. Box 5163, Denver, Colorado 80217 USA  
Phone: 303-675-2175 or 800-344-3860 Toll Free USA/Canada  
Fax: 303-675-2176 or 800-344-3867 Toll Free USA/Canada  
Email: [orderlit@onsemi.com](mailto:orderlit@onsemi.com)

**N. American Technical Support:** 800-282-9855 Toll Free  
USA/Canada  
**Europe, Middle East and Africa Technical Support:**  
Phone: 421 33 790 2910  
**Japan Customer Focus Center**  
Phone: 81-3-5817-1050

**ON Semiconductor Website:** [www.onsemi.com](http://www.onsemi.com)

**Order Literature:** <http://www.onsemi.com/orderlit>

For additional information, please contact your local Sales Representative

# Mouser Electronics

Authorized Distributor

Click to View Pricing, Inventory, Delivery & Lifecycle Information:

[ON Semiconductor:](#)

[TIP41AG](#) [TIP41BG](#) [TIP41CG](#) [TIP42AG](#) [TIP42BG](#) [TIP42CG](#) [TIP42G](#)