

TR-EM1P-UNI

time relays



- **Multifunction time relays (7 time functions; 7 time ranges)**
- AC/DC input voltages
- Cover - installation module, width 17,5 mm
- Direct mounting on 35 mm rail mount acc. to PN-EN 60715
- Application: in low-voltage systems
- Recognitions, certifications, directives: **CE EAC**

Output circuit - contact data

Number and type of contacts	1 CO	
Contact material	AgNi	
Rated load	AC1	8 A / 250 V AC
Max. breaking capacity	AC1	2 000 VA (8 A / 250 V AC)
Max. operating frequency	3 600 cycles/hour	
• at resistive load 100 VA	360 cycles/hour	
• at resistive load 1 000 VA		
Input circuit		
Rated voltage	AC: 50/60 Hz AC/DC	12...240 V terminals (+)A1 – (-)A2
Must release voltage	AC: $\geq 0,3 U_n$	
Operating range of supply voltage	0,9...1,1 U_n	
Rated power consumption	AC	4,0 VA
	DC	1,5 W
Range of supply frequency	AC	48...63 Hz
Duty cycle	100%	
Residual ripple to DC	10%	
Control contact S ①		
• min. time of pulse duration ②	AC: ≥ 100 ms DC: ≥ 50 ms	
• loadable	yes	
• max. length of control line	10 m	
• trigger level (sensitivity)	automatic adaption to supply voltage	
Insulation according to PN-EN 60664-1		
Insulation rated voltage	250 V AC	
Rated surge voltage	4 000 V 1,2 / 50 μ s	
Overvoltage category	III	
Insulation pollution degree	2 if built-in: 3	
Dielectric strength • contact clearance	1 000 V AC type of clearance: micro-disconnection	
General data		
Electrical life • resistive AC1	$> 2 \times 10^5$ 1 000 VA	
Mechanical life (cycles)	$> 2 \times 10^7$	
Dimensions (L x W x H)	87 x 17,5 x 65 mm	
Weight	63 g	
Ambient temperature • storage	-25...+70 °C	
• operating	-25...+55 °C	
Cover protection category	IP 20 PN-EN 60529	
Relative humidity	15...85%	
Shock resistance	15 g 11 ms	
Vibration resistance	0,35 mm DA 10...55 Hz	
Time module data		
Functions ③	E, Wu, Bp, R, Ws, Wa, Es	
Time ranges	1 s; 10 s; 1 min.; 10 min.; 1 h; 10 h; 100 h	
Timing adjustment	smooth - (0,05...1) x time range	
Base accuracy	$\pm 1\%$ (calculated from the final range values)	
Setting accuracy	$\pm 5\%$ (calculated from the final range values)	
Repeatability	$\pm 0,5\%$ or ± 5 ms	
Temperature influence	$\pm 0,01\%$ / °C	
Recovery time	100 ms	
LED indicator	green LED U ON - indication of supply voltage U green LED U flashing - measurement of T time yellow LED R ON/OFF - output relay status	

① The control terminal S is activated by connection to A1 terminal via the external control contact S.

② Where the control signal is recognizable.

③ The function has to be set before connecting the relay to the supply voltage.

14.07.2014

Time functions

E - ON delay.

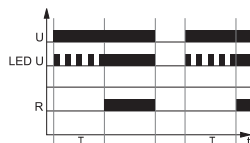

When the supply voltage U is applied, the set interval T begins (green LED flashes). After the interval T has expired (green LED illuminated) the output relay R switches into on-position (yellow LED illuminated). This status remains until the supply voltage is interrupted. If the supply voltage is interrupted before the expiry of the interval T, the interval already expired is erased and is restarted when the supply voltage is next applied.

Wu - ON for the set interval.

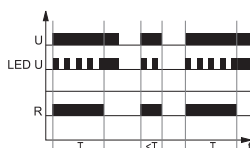

When the supply voltage U is applied, the output relay R switches into on-position (yellow LED illuminated) and the set interval T begins (green LED flashes). After the interval T has expired (green LED illuminated) the output relay switches into off-position (yellow LED not illuminated). This status remains until the supply voltage is interrupted. If the supply voltage is interrupted before the interval T has expired, the output relay switches into off-position. The interval already is erased and is restarted when the supply voltage is next applied.

Bp - Symmetrical cyclical operation pause first.

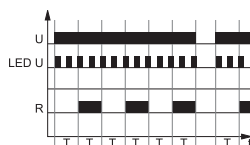

When the supply voltage U is applied, the set interval T begins (green LED flashes). After the interval T has expired, the output relay R switches into on-position (yellow LED illuminated) and the set interval T begins again. After the interval T has expired, the output relay switches into off-position (yellow LED not illuminated). The output relay is triggered at a ratio of 1:1 until the supply voltage is interrupted.

R - OFF delay with the control contact S.



The supply voltage U must be constantly applied to the device (green LED illuminated). When the control contact S is closed, the output relay R switches into on-position (yellow LED illuminated). If the control contact is opened, the set interval T begins (green LED flashes). After the interval T has expired (green LED illuminated) the output relay switches into off-position (yellow LED not illuminated). If the control contact is closed again before the interval T has expired, the interval already expired is erased and is restarted.

U - supply voltage; R - output state of the relay; S - control contact state; T - measured time; t - time axis

Ws - Single shot for the set interval triggered by closing of the control contact S.



The supply voltage U must be constantly applied to the device (green LED illuminated). When the control contact S is closed, the output relay R switches into on-position (green LED illuminated) and the set interval T begins (green LED flashes). After the interval T has expired (green LED illuminated) the output relay switches into off-position (yellow LED not illuminated). During the interval, the control contact can be operated any number of times. A further cycle can only be started when the cycle run has been completed.

Wa - ON for the set interval triggered with the control contact S.

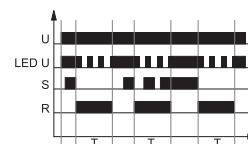

The supply voltage U must be constantly applied to the device (green LED illuminated). Closing the control contact S has no influence on the condition of the output R. When the control contact is opened, the output relay switches into on-position (yellow LED illuminated) and the set interval T begins (green LED flashes). After the interval T has expired (green LED illuminated), the output relay switches into off-position (yellow LED not illuminated). During the interval, the control contact can be operated any number of times. A further cycle can only be started when the cycle run has been completed.

Es - ON delay with the control contact S.

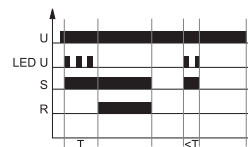

The supply voltage U must be constantly applied to the device (green LED illuminated). When the control contact S is closed, the set interval T begins (green LED flashes). After the interval T has expired (green LED illuminated) the output relay R switches into on-position (yellow LED illuminated). This status remains until the control contact is opened again. If the control contact is opened before the interval T has expired, the interval already expired is erased and is restarted with the next cycle.

TR-EM1P-UNI

time relays

Dimensions

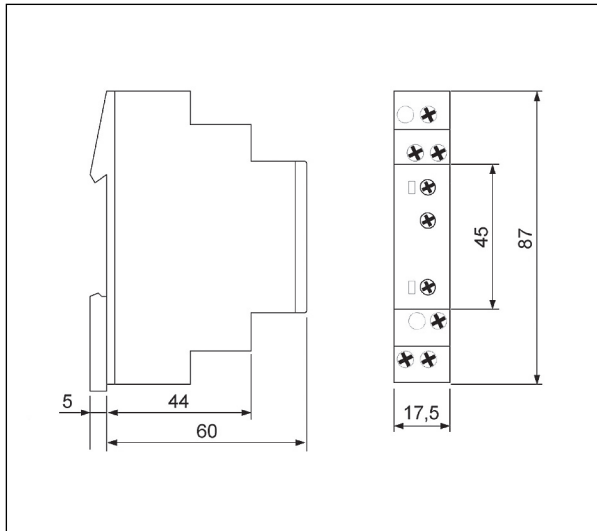

Front panel description

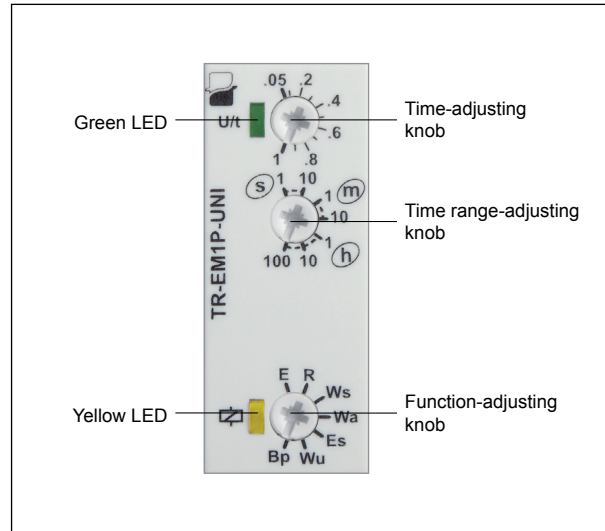

Connection diagrams

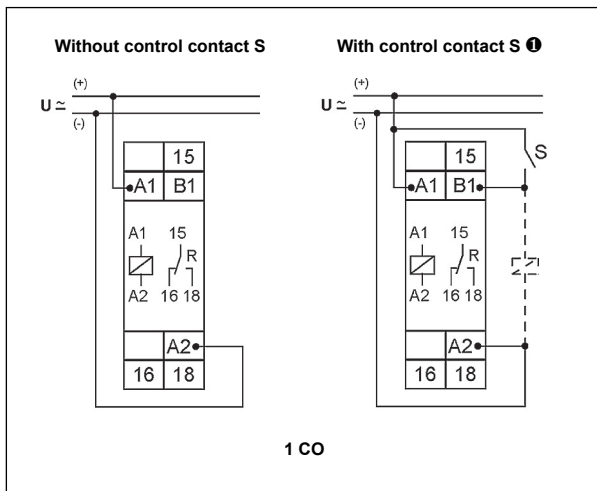

Mounting

Relays **TR-EM1P-UNI** are designed for direct mounting on 35 mm rail mount acc. to PN-EN 60715. Operational position - any. **Connections:** max. cross section of the cables: $1 \times 2,5 \text{ mm}^2 / 2 \times 1,5 \text{ mm}^2$ (1 x 14 / 2 x 16 AWG), length of the cable deinsulation: 6,5 mm, max. tightening moment for the terminal: 1,0 Nm. Shockproof terminal connection according to VBG 4 (PZ1 required).

❶ The control terminal S is activated by connection to A1 terminal via the external control contact S.

Ordering codes

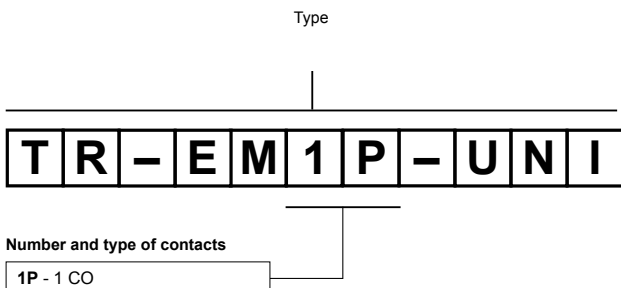

Example of ordering codes:

TR-EM1P-UNI

time relay **TR-EM1P-UNI**, multifunction (relay perform 7 functions), cover - installation module, width 17,5 mm, one changeover contact, rated input voltage 12...240 V AC/DC AC: 50/60 Hz

PRECAUTIONS:

1. Ensure that the parameters of the product described in its specification provide a safety margin for the appropriate operation of the device or system and never use the product in circumstances which exceed the parameters of the product. 2. Never touch any live parts of the device. 3. Ensure that the product has been connected correctly. An incorrect connection may cause malfunction, excessive heating or risk of fire. 4. In case of any risk of any serious material loss or death or injuries of humans or animals, the devices or systems shall be designed so to equip them with double safety system to guarantee their reliable operation.