

1 2 3 4 5 6

A

B

C

D

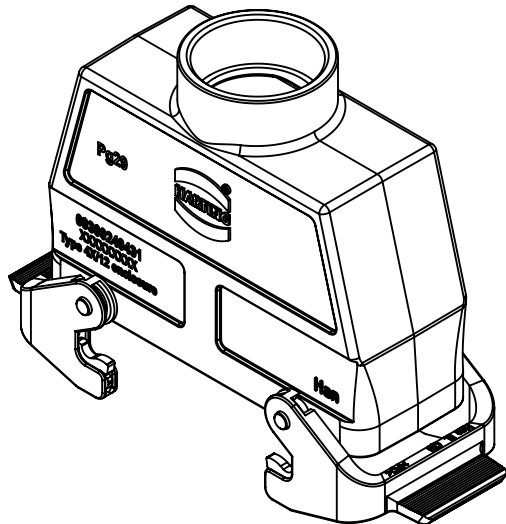
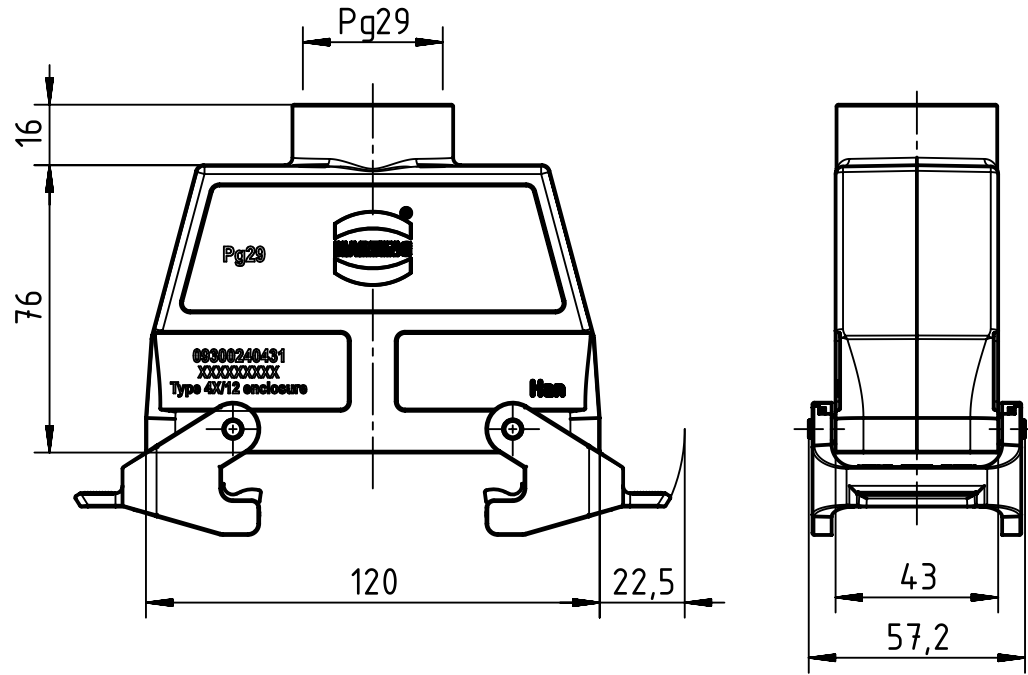

	All Dimensions in mm Original Size DIN A4		Scale 1:2	Free size tol.		Ref.		
						Sub.		
	All rights reserved		Created by SPRENB	Inspected by GERB	Standardisation TIEMANNA	Date 2018-12-11	State Final Release	
	Department EL PD		Title Han B Hood Top Entry HC 2 Levers PG 29				Doc-Key / ECM-Nr. 100118462/UGD/006/B 500000143929	
HARTING Electric GmbH & Co. KG D-32339 Espelkamp			Type TB	Number 09 30 024 0431			Rev. B	Page 1/1