

Panasonic[®]

Operating Instructions

Digital Corded/Cordless Answering System

Model No. **KX-TGF320E**



Before initial use, see “Getting Started” on page 10.

Thank you for purchasing a Panasonic product.

Please read these operating instructions before using the unit and save them for future reference.

Table of Contents

Introduction		
Accessory information	3	
General information	4	
Important Information		
For your safety	6	
Important safety instructions	7	
For best performance	7	
Other information	8	
Specifications	8	
Getting Started		
Setting up	10	
Controls	13	
Display icons	14	
Turning the power on/off	15	
Language setting	15	
Date and time	15	
Recording your greeting message	15	
Other settings	16	
Making/Answering Calls		
Making calls	17	
Answering calls	18	
Useful features during a call	18	
Intercom	20	
Key lock	21	
Nuisance Call Block		
Using the call block button	22	
Storing unwanted callers	22	
Phonebook		
Phonebook	24	
Speed dial	25	
One-touch dial buttons	27	
Programming		
Menu list	28	
Alarm	33	
Do not disturb mode	34	
Baby monitor	34	
Other programming	36	
Registering a unit	37	
Caller ID Service		
Using Caller ID service	39	
Caller list	39	
Answering System		
Answering system	41	
Turning the answering system on/off	41	
Greeting message	41	
Listening to messages	42	
Advanced new message alerting features	43	
Remote operation	45	
Answering system settings	46	
Useful Information		
Voicemail service	48	
Wall mounting	48	
Character entry	49	
Error messages	51	
Troubleshooting	51	
Conditions of guarantee	55	
Index		
Index.....	56	

Accessory information

Supplied accessories

No.	Accessory item/Part number	Quantity
①	AC adaptor for base unit/PNLV226E0X	1
②	Telephone line cord/PNJA1113Y (Black/for U.K.) or PNJA1037Z (Transparence/for U.K.)	1
③	Desk stand/Wall mounting adaptor ^{*1} /PNKL1051Z1	1
④	Corded handset/PNLXP1005Y	1
⑤	Corded handset cord/PQJA212V	1
⑥	Rechargeable batteries ^{*2}	2
⑦	Handset cover ^{*3}	1
⑧	Belt clip/PNKE1268Z1	1
⑨	Charger/PNLC1065ZB	1
⑩	AC adaptor for charger/PNLV233EKX	1

*1 The desk stand/wall mounting adaptor comes attached to the base unit.

*2 See page 3 for replacement battery information.

*3 The handset cover comes attached to the handset.

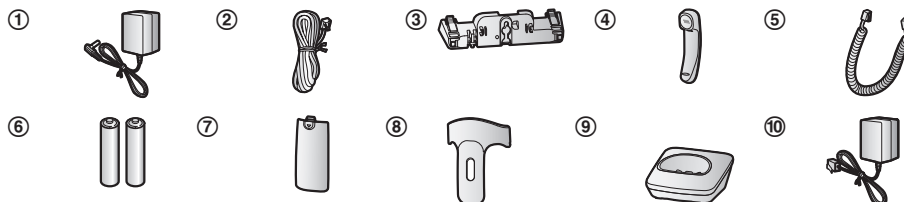

Additional/replacement accessories

Please contact your nearest Panasonic dealer for sales information.

Accessory item	Model number
Rechargeable batteries ^{*1}	Battery type: – Nickel metal hydride (Ni-MH) – 2 x AAA (R03) size for each handset – 1.2 V – Minimum amperage of 550 mAh
Headset	RP-TCA400
DECT repeater	KX-A405, KX-A406
Key finder	KX-TGA20EX ^{*2}

*1 Replacement batteries may have a different capacity from that of the supplied batteries.
We recommend using Panasonic rechargeable batteries.

Introduction

- *2 By registering the key finder (4 max.) to a Panasonic Digital Cordless Phone and attaching it to an easy-to-lose item in advance, you can locate and find the mislaid item to which the key finder is attached. Please visit our Web site:

www.panasonic.net/pcc/products/telephone/p/tga20/

Please contact Panasonic or authorised sales department for availability of key finder in your area.

Other information

- Design and specifications are subject to change without notice.
- The illustrations in these instructions may vary slightly from the actual product.

Expanding your phone system

Handset (optional): KX-TGFA30E	
<p>You can expand your phone system by registering optional handsets (6 max.) to a single base unit.</p> <ul style="list-style-type: none">● Optional handsets may be a different colour from that of the supplied handsets.	

Sales and support information

Customer Communications Centre

- For customers within the U.K.: 0844 844 3899
- For customers within Ireland: 01289 8333
- For further support on your product, please visit our website: www.panasonic.co.uk

Direct Sales at Panasonic U.K.

- Order accessory and consumable items for your product with ease and confidence by phoning our Customer Communications Centre Monday - Friday 9:00am - 5:00pm (Excluding public holidays).
- Go on line through our Internet Accessory ordering application at www.pas-europe.com
- Most major credit and debit cards accepted.
- All enquiries transactions and distribution facilities are provided directly by Panasonic U.K.
- Also available through our Internet is direct shopping for a wide range of finished products. Take a browse on our website for further details.
shop.panasonic.co.uk/

General information

- This equipment is designed for use on the U.K. and Ireland analogue telephone network.
- In the event of problems, you should contact your equipment supplier in the first instance.

Declaration of Conformity:

- Panasonic Corporation declares that the radio equipment type (KX-TGF320) is in compliance with Directive 2014/53/EU. The full text of the EU declaration of conformity is available at the following internet address:

<http://www.ptc.panasonic.eu/doc>

Contact to Authorised Representative:

Introduction

Panasonic Testing Centre
Panasonic Marketing Europe GmbH
Winsbergring 15, 22525 Hamburg, Germany

Ecodesign information

Ecodesign information under EU Regulation (EC) No. 1275/2008 amended by (EU) Regulation No. 801/2013. From 1 January 2015.

Please visit here: <http://www.ptc.panasonic.eu/erp>

Click [Downloads]

→ Energy related products information (Public)

Power consumption in networked standby and guidance are mentioned in the web site above.

For your future reference

We recommend keeping a record of the following information to assist with any repair under warranty.

Serial No.	Date of purchase
(found on the bottom of the base unit)	
Name and address of dealer	

Attach your purchase receipt here.

Important Information

For your safety

To prevent severe injury and loss of life/property, read this section carefully before using the product to ensure proper and safe operation of your product.

WARNING

Power connection

- Use only the power source marked on the product.
- Do not overload power outlets and extension cords. This can result in the risk of fire or electric shock.
- Completely insert the AC adaptor/power plug into the power outlet. Failure to do so may cause electric shock and/or excessive heat resulting in a fire.
- Regularly remove any dust, etc. from the AC adaptor/power plug by pulling it from the power outlet, then wiping with a dry cloth. Accumulated dust may cause an insulation defect from moisture, etc. resulting in a fire.
- Unplug the product from power outlets if it emits smoke, an abnormal smell, or makes an unusual noise. These conditions can cause fire or electric shock. Confirm that smoke has stopped emitting and contact an authorised service centre.
- Unplug from power outlets and never touch the inside of the product if its casing has been broken open.
- Never touch the plug with wet hands. Danger of electric shock exists.

Installation

- To prevent the risk of fire or electrical shock, do not expose the product to rain or any type of moisture.
- Do not place or use this product near automatically controlled devices such as automatic doors and fire alarms. Radio waves emitted from this product may cause such devices to malfunction resulting in an accident.
- Do not allow the AC adaptor or telephone line cord to be excessively pulled, bent or placed under heavy objects.

Operating safeguards

- Unplug the product from power outlets before cleaning. Do not use liquid or aerosol cleaners.
- Do not disassemble the product.
- Do not spill liquids (detergents, cleansers, etc.) onto the telephone line cord plug, or allow it to become wet at all. This may cause a fire. If the telephone line cord plug becomes wet, immediately pull it from the telephone wall jack, and do not use.
- Do not excessively pull the corded handset cord from the base unit. This may cause the base unit to fall, resulting in injury.
- The use of excessive sound volume through earphones, headphones, or headsets may cause hearing loss.

Medical

- Consult the manufacturer of any personal medical devices, such as pacemakers or hearing aids, to determine if they are adequately shielded from external RF (radio frequency) energy. (The product operates in the frequency range of 1.88 GHz to 1.90 GHz, and the RF transmission power is 250 mW (max.).)
- Do not use the product in health care facilities if any regulations posted in the area instruct you not to do so. Hospitals or health care facilities may be using equipment that could be sensitive to external RF energy.

CAUTION

Installation and location

- Never install telephone wiring during an electrical storm.
- Never install telephone line jacks in wet locations unless the jack is specifically designed for wet locations.
- Never touch uninsulated telephone wires or terminals unless the telephone line has been disconnected at the network interface.
- Use caution when installing or modifying telephone lines.
- The AC adaptor is used as the main disconnect device. Ensure that the AC outlet is installed near the product and is easily accessible.
- This cordless handset is unable to make calls when:
 - the handset batteries need recharging or have failed.
 - there is a power failure.

Important Information

- the key lock feature is turned on.

Ni-MH rechargeable batteries

- We recommend using the batteries noted on page 3. **USE ONLY rechargeable Ni-MH batteries AAA (R03) size.**
- Do not mix old and new batteries.
- Do not open or mutilate the batteries. Released electrolyte from the batteries is corrosive and may cause burns or injury to the eyes or skin. The electrolyte is toxic and may be harmful if swallowed.
- Exercise care when handling the batteries. Do not allow conductive materials such as rings, bracelets, or keys to touch the batteries, otherwise a short circuit may cause the batteries and/or the conductive material to overheat and cause burns.
- Charge the batteries provided with or identified for use with this product only, in accordance with the instructions and limitations specified in this manual.
- Only use a compatible base unit (or charger) to charge the batteries. Do not tamper with the base unit (or charger). Failure to follow these instructions may cause the batteries to swell or explode.

Note when using alkaline batteries for power backup

- The batteries should be used correctly, otherwise the unit may be damaged due to battery leakage.
- Do not charge, short-circuit, disassemble, or heat the batteries.
- Do not dispose of batteries in a fire.
- Remove all the batteries when replacing.
- Do not mix old, new or different types of batteries.
- It is recommended that batteries are replaced annually.
- It is recommended that batteries are replaced after a power outage.

Important safety instructions

When using your product, basic safety precautions should always be followed to reduce the risk of fire, electric shock, and injury to persons, including the following:

1. Do not use this product near water for example, near a bathtub, washbowl, kitchen

sink, or laundry tub, in a wet basement or near a swimming pool.

2. Avoid using a telephone (other than a cordless type) during an electrical storm. There may be a remote risk of electric shock from lightning.
3. Do not use the telephone to report a gas leak in the vicinity of the leak.
4. Use only the power cord and batteries indicated in this manual. Do not dispose of batteries in a fire. They may explode. Check with local codes for possible special disposal instructions.

SAVE THESE INSTRUCTIONS

For best performance

Base unit location/avoiding noise

The base unit and other compatible Panasonic units use radio waves to communicate with each other.

- For maximum coverage and noise-free communications, place your base unit:
 - at a convenient, high, and central location with no obstructions between the cordless handset and base unit in an indoor environment.
 - away from electronic appliances such as TVs, radios, personal computers, wireless devices, or other phones.
 - facing away from radio frequency transmitters, such as external antennas of mobile phone cell stations. (Avoid putting the base unit on a bay window or near a window.)
- Coverage and voice quality depends on the local environmental conditions.
- If the reception for a base unit location is not satisfactory, move the base unit to another location for better reception.

Environment

- Keep the product away from electrical noise generating devices, such as fluorescent lamps and motors.
- The product should be kept free from excessive smoke, dust, high temperature, and vibration.
- The product should not be exposed to direct sunlight.
- Do not place heavy objects on top of the product.
- When you leave the product unused for a long period of time, unplug the product from the power outlet.

Important Information

- The product should be kept away from heat sources such as radiators, cookers, etc. It should not be placed in rooms where the temperature is less than 0 °C or greater than 40 °C. Damp basements should also be avoided.
- The maximum calling distance may be shortened when the product is used in the following places: Near obstacles such as hills, tunnels, underground, near metal objects such as wire fences, etc.
- Operating the product near electrical appliances may cause interference. Move away from the electrical appliances.

Routine care

- **Wipe the outer surface of the product with a soft moist cloth.**
- Do not use benzene, thinner, or any abrasive powder.

Other information

CAUTION: Risk of explosion if battery is replaced by an incorrect type. Dispose of used batteries according to the instructions.

Notice for product disposal, transfer, or return

- This product can store your private/confidential information. To protect your privacy/confidentiality, we recommend that you erase information such as phonebook or caller list entries from the memory before you dispose of, transfer, or return the product.

Information for Users on Collection and Disposal of Old Equipment and used Batteries

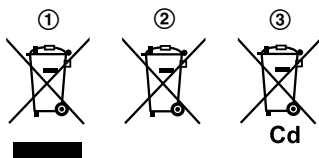

These symbols (①, ②, ③) on the products, packaging, and/or accompanying documents mean that used electrical and electronic products and batteries should not be mixed with general household waste.

For proper treatment, recovery and recycling of old products and used batteries, please take them to applicable collection points, in accordance with

your national legislation and the Directives 2002/96/EC and 2006/66/EC.

By disposing of these products and batteries correctly, you will help to save valuable resources and prevent any potential negative effects on human health and the environment which could otherwise arise from inappropriate waste handling. For more information about collection and recycling of old products and batteries, please contact your local municipality, your waste disposal service or the point of sale where you purchased the items.

Penalties may be applicable for incorrect disposal of this waste, in accordance with national legislation.

For business users in the European Union

If you wish to discard electrical and electronic equipment, please contact your dealer or supplier for further information.

Information on Disposal in other Countries outside the European Union

These symbols (①, ②, ③) are only valid in the European Union. If you wish to discard these items, please contact your local authorities or dealer and ask for the correct method of disposal.

Note for the battery symbol

This symbol (②) might be used in combination with a chemical symbol (③). In this case it complies with the requirement set by the Directive for the chemical involved.

Note for battery removal procedure

Refer to "Handset battery charging" on page 11.

Specifications

- **Standard:**
DECT (Digital Enhanced Cordless Telecommunications),
GAP (Generic Access Profile)
- **Frequency range:**
1.88 GHz to 1.90 GHz
- **RF transmission power:**
Approx. 10 mW (average power per channel)
250 mW (max.)
- **Power source:**
100–240 V AC, 50/60 Hz
- **Power consumption:**
Base unit:

Important Information

Standby: Approx. 0.6 W
Maximum: Approx. 2.8 W

Charger:

Standby: Approx. 0.12 W
Maximum: Approx. 1.8 W

● **Operating conditions:**

0 °C–40 °C, 20 %–80 % relative air humidity
(dry)

Getting Started

Setting up

Connections

■ Base unit

- ① Connect the AC adaptor to the unit by pressing the plug firmly.
- ② Connect the telephone line cord to the unit until you hear a click.
- ③ Fasten the AC adaptor cord and the telephone line cord by hooking it.
- ④ Connect the AC adaptor to the power outlet.
- ⑤ Connect the telephone line cord to the telephone line jack until you hear a click.
- ⑥ A DSL/ADSL filter (not supplied) is required if you have a DSL/ADSL service.
- ⑦ Connect the corded handset cord to the base unit until you hear a click.

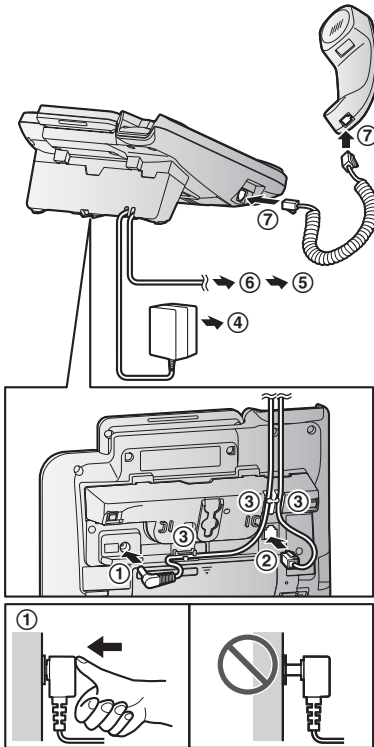

Note:

- Use only the supplied Panasonic AC adaptor PNLV226E.

- Use only the supplied telephone line cord.

- Follow the directions on the display to set up the unit.

■ Charger

- ① Connect the AC adaptor plug to the unit until you hear a click.
- ② Connect the AC adaptor to the power outlet.

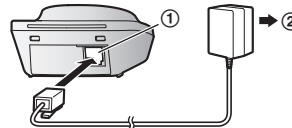

Note:

- Use only the supplied Panasonic AC adaptor PNLV233E.

Handset battery installation

- USE ONLY rechargeable Ni-MH batteries AAA (R03) size (A).
- Do NOT use alkaline/manganese/Ni-Cd batteries.
- Confirm correct polarities (+, -).

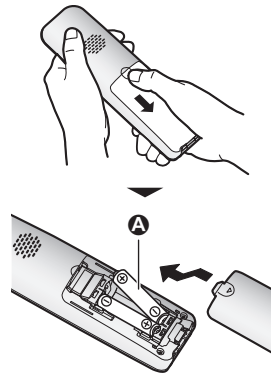

- Follow the directions on the display to set up the unit.

Handset battery charging

Charge for about 7 hours.

- Confirm “Charging” is displayed (A).
- When the batteries are fully charged, “Fully Charged” is displayed.



Handset battery level

Icon	Battery level
	High
	Medium
	Low
	Needs charging.

Panasonic Ni-MH battery performance (supplied batteries)

Operation	Operating time
In continuous use	17 hours max.
Not in use (standby)	330 hours max.

Note:

- Actual battery performance depends on usage and ambient environment.
- When eco mode is set to “Eco Plus”, the base unit stops communicating with the handset while it is in standby mode. As a result, the handset uses more power than usual to search for the base unit and therefore battery usage time is shortened (page 16).

Base unit battery installation (for power backup)

You can insert 2 AAA (R03) batteries (not supplied) into the base unit that will power the unit temporarily in the event of a power failure.

Important:

- The following batteries can be used with the base unit:

- Rechargeable Ni-MH batteries*1. *2 (including the batteries used in your handset(s))
- Standard (non-rechargeable) alkaline batteries*3

- Do NOT use manganese batteries.
- Confirm correct polarities (⊕, ⊖).

*1 The base unit can fully charge Ni-MH batteries in about 15 hours.

*2 We recommend using Panasonic rechargeable batteries (page 3).

*3 Only insert alkaline batteries once a power failure occurs. Remove the alkaline batteries when power is restored.

- 1 Disconnect the telephone line cord (1).
- 2 Open the battery cover (2).
- 3 Install the batteries in the battery compartment (3).
- 4 Close the cover, then reconnect the telephone line cord (4).

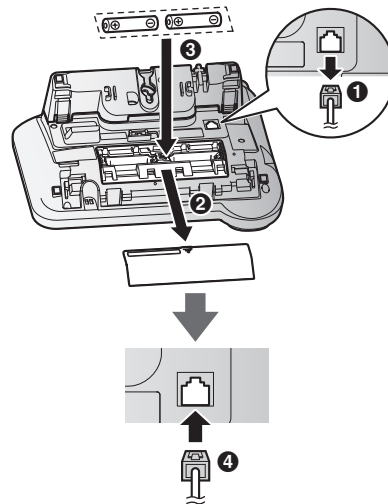

Note:

- If your phone service provider requires additional devices in order to make and receive calls, such as a modem, you may still not be able to make and receive calls even if the base unit's backup power feature is functioning.

Base unit battery status when a power failure occurs

Icon	Battery status
	Power backup mode is on.

Getting Started

Icon	Battery status
	Battery power is low.*1

- *1 If  begins flashing on the base unit, replace the batteries with new ones as soon as possible. If you replace Ni-MH batteries with alkaline batteries, insert the Ni-MH batteries into the base unit again after the power is restored so that they will be recharged.

Battery saving mode setting

This feature allows the base unit to reduce its power consumption by limiting the available functions and therefore extend battery life during a power failure.

The following settings are available:

- “On” : The unit will work as a standard telephone. Only the corded handset can be used to make and receive calls. (You cannot use the base unit display, phonebook, one-touch dial, answering system, speakerphone, etc.)
The base unit display is blank.
- “OFF” (default): You can use the full functions of the base unit, but battery life is not extended. The brightness level for the base unit display is lowered.

Base unit

- 1 [MENU]#150
- 2 [↕]: Select the desired setting.
- 3 [OK] → [EXIT]

Note:

- Once the battery saving mode is set to “On”, the unit rings with the volume level 1 even if the ringer volume for the base unit is set to “OFF” to let you know an incoming call is being received.

Panasonic Ni-MH battery performance (optional batteries) when operating on backup battery power

Operation	Saving mode	
	Off	On
In continuous use	3 hours max.	10 hours max.
Not in use (standby)	4 hours max.	12 hours max.

Note:

- Battery performance depends on the type of batteries.
- Actual battery performance depends on usage and ambient environment.

Note when setting up

Note for connections

- The AC adaptor must remain connected at all times. (It is normal for the adaptor to feel warm during use.)
- The AC adaptor should be connected to a vertically oriented or floor-mounted AC outlet. Do not connect the AC adaptor to a ceiling-mounted AC outlet, as the weight of the adaptor may cause it to become disconnected.

Note for Ni-MH battery installation

- **Handset:** Use the supplied rechargeable batteries.
- **Handset/Base unit:** For replacement, we recommend using the Panasonic rechargeable batteries noted on page 3, 7.

Note for battery charging

- It is normal for the handset to feel warm during charging.
- Clean the charge contacts of the handset and charger with a soft and dry cloth once a month. Before cleaning the unit, disconnect from power outlets and any telephone line cords. Clean more often if the unit is exposed to grease, dust, or high humidity.

Controls

Handset

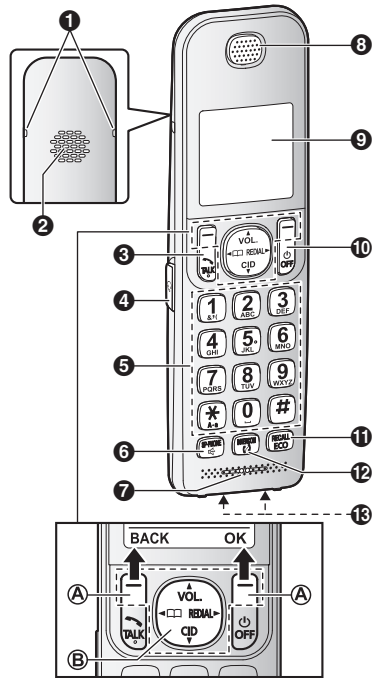

- 1 Belt clip holes
- 2 Speaker
- 3 [TALK]
- 4 Headset jack
- 5 Dial keypad
- 6 [SP-PHONE: Speakerphone]
- 7 Microphone
- 8 Receiver
- 9 Display
- 10 [Power] [OFF]
- 11 [RECALL] [ECO]
ECO: Eco mode shortcut key
- 12 [INTERCOM]
- 18 Charge contacts

Control type

A Soft keys

By pressing a soft key, you can select the feature shown directly above it on the display.
(Example: MENU, OK, etc.)

B Navigator key

- [▲], [▼], [◀], or [▶]: Scroll through various lists and items.
- VOL. (Volume: [▲] or [▼]): Adjust the receiver or speaker volume while talking.
- [◀] [☐]: View the phonebook entry.
- [▶] [RECALL]: View the redial list.
- [▼] [CID (Caller ID)]: View the caller list.

Base unit

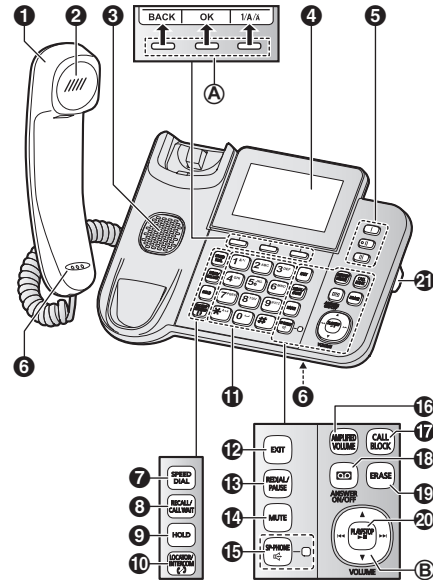

- 1 Corded handset
- 2 Receiver
- 3 Speaker
- 4 Display
 - The display can be moved back and forth to select the desired angle.
- 5 One touch dial buttons ([I]/[II]/[III])
- 6 Microphone
- 7 [SPEED DIAL]
- 8 [RECALL] [CALL WAIT]
- 9 [HOLD]
- 10 [LOCATOR/INTERCOM]
 - You can locate a misplaced handset by pressing [LOCATOR/INTERCOM].
- 11 Dial keypad
- 12 [EXIT]
- 13 [REDIAL] [PAUSE]
- 14 [MUTE]
- 15 [SP-PHONE: Speakerphone]
SP-PHONE indicator
- 16 [AMPLIFIED VOLUME]

Getting Started

- 17 [CALL BLOCK]
- 18 [ANS] (ANSWER ON/OFF)
ANSWER ON/OFF indicator (ANS)
- 19 [ERASE]
- 20 [▶■] (PLAY/STOP)
Message indicator
- 21 Desk stand/Wall mounting adaptor
 - The adaptor is a removable attachment for desk stand or wall mounting use (page 48).

Control type

A Soft keys

By pressing a soft key, you can select the feature shown directly above it on the display.
(Example: MENU, OK, etc.)

B Navigator key

- [▲], [▼], [◀], or [▶]: Scroll through various lists and items.
- VOLUME ([▲] or [▼]): Adjust the receiver or speaker volume while talking.
- [◀◀]/[▶▶]: Repeat/skip messages during playback.

Display icons

Display items

Item	Meaning
*1	Range status: The more bars visible, the closer the handset is to the base unit.
*1	Out of base unit range
	Security for phone calls is set to "Enhanced". (page 37)
	Paging, intercom mode
*1	Speakerphone is on. (page 17)
*1 *2	The line is in use. <ul style="list-style-type: none"> • When flashing slowly: The call is put on hold. • When flashing rapidly: An incoming call is now being received.
	Missed call*3 (page 39)
	Eco mode is set to "Eco". (page 16)
	Eco mode is set to "Eco Plus". (page 16)

Item	Meaning
*1	Noise reduction is set. (page 19)
*1	The LCD and key backlight is off. (page 31)
	<ul style="list-style-type: none"> • When displayed next to the battery icon: Answering system is on.*1 (page 41) • When displayed with a number: New messages have been recorded. (page 42)
	"Greeting Only" is selected. Caller messages are not recorded. (page 47)
*1	Battery level
*2	Power backup mode is on. (page 11)
*1	Alarm is on. (page 33)
	Privacy mode is on. (page 31)
	Ringer volume is off. (page 30)
	Do not disturb mode is on. (page 34)
	Nuisance call blocked.*3 (page 22)
	New voicemail message received.*4 (page 48)
*1	Baby monitor is activated. The name/number displayed next to the icon indicates the monitoring unit. (page 34)
Line in use	Someone is using the line.
IN USE	Answering system is being used by another handset or the base unit.

*1 Handset



*2 Base unit

*3 Caller ID subscribers only





















*4 Voicemail subscribers only

Soft key icons

Icon	Action
OK	Accepts the current selection.
12/24*1	Sets 24-hour or 12-hour clock format. (page 15)
	Temporarily turns off the ringer for incoming calls. (page 18)

Icon	Action
 *1	Opens the phonebook.
 *1	Selects a character entry mode.
 *2	Turns the key lock feature off. (page 21)

■ When you select a language other than English

Icon	Action
	Returns to the previous screen or outside call.
	Displays the menu.
	Makes a call.
 *2	Places a call on hold.
 *2	Rejects calls from unwanted callers.
 *1	Switches the screen to confirm the detailed information.
	Allows you to edit phone numbers.
	Adds new entry.
	Displays the phonebook search menu.
 *2	Stops alarm.
 *2	Snooze button on the alarm.
	Selects entries or handsets.
 *1	Opens the caller list.
	Stops recording or playback.
	Stores phone numbers.
	Erases the selected item.
 *2	Allows you to make an intercom call.
 *1	Establishes a conference call.
	Erases a number/character.
	Puts the call on mute.

*1 Base unit

*2 Handset

Turning the power on/off

Handset

Press  for about 2 seconds.

Language setting

Display language

Handset / Base unit

- 1 **[MENU]**#**[1]****[1]****[0]**
- 2 **[↓]**: Select your desired language. → **[OK]**
- 3 Proceed with the operation for your unit.
Handset: [OFF]
Base unit: [EXIT]

Date and time

You can configure this setting using either the base unit or one of the handsets.

Handset / Base unit

- 1 **[MENU]**#**[1]****[0]****[1]**
- 2 Enter the current date, month, and year. → **[OK]**
Example: 12 July, 2015
[1]**[2]** **[0]****[7]** **[1]****[5]**
- 3 Enter the current hour and minute.
Example: 9:30
[0]**[9]** **[3]****[0]**
 - You can select 24-hour or 12-hour clock format (“**AM**” or “**PM**”) by:
 - pressing **[X]** on the handset.
 - pressing **[12/24]** on the base unit.
- 4 **[OK]**
- 5 Proceed with the operation for your unit.
Handset: [OFF]
Base unit: [EXIT]

Recording your greeting message

You can record your own greeting message instead of using a pre-recorded greeting message. See page 41 for details.

You can configure this setting using either the base unit or one of the handsets.

Handset / Base unit

- 1 **[MENU]**#**[3]****[0]****[2]**

Getting Started

- 2 [↕]: “Yes” → [OK]
- 3 Record a greeting message. → [STOP]
- 4 Proceed with the operation for your unit.
Handset: [OFF]
Base unit: [EXIT]

Other settings

Eco mode setting

Handset

You can select the desired eco mode setting by pressing [ECO].

The following settings are available for eco mode.

- “Eco”: Reduces the base unit transmission power by up to 90 % in standby mode.
When this setting is selected, [ECO] is displayed.*1
- “Eco Plus”: Reduces the base unit transmission power completely in standby mode.
When this setting is selected, [ECO+] is displayed.*1
- “Eco Off” (default setting): Turns off eco mode.
When this setting is selected, [ECO/ECO+] are not displayed.

*1 Handset: [ECO/ECO+] are displayed instead of ∇.

Note:

- If there is a handset that is not compatible with Eco Plus registered to the base unit, “Eco Plus” is not available. If that handset is registered while “Eco Plus” was already selected, the setting changes to “Eco Off”.
- When there is another cordless phone in use nearby, the base unit transmission power may not be reduced.
- When eco mode is set to “Eco Plus”, there is a delay between when calls are received and when the handset starts ringing.
- When eco mode is active, the range of the base unit is reduced in standby mode.
- If you set repeater mode to “On” (page 38):
 - Eco mode is disabled.
 - “Eco Mode” is not displayed in the display menu (page 31).
- When eco mode is set to “Eco Plus”, battery usage time is shortened (page 11).

Making calls

Using the handset

- 1 Lift the handset and dial the phone number.
 - To correct a digit, press **[CLEAR]**.
- 2 **[↶]**
- 3 When you finish talking, press **[OFF]** or place the handset on the charger.

Using the speakerphone

- 1 Dial the phone number and press **[☎]**.
- 2 When you finish talking, press **[OFF]**.

Note:

- To switch back to the receiver, press **[☎]/[↶]**.

Making a call using the redial list

The last 10 phone numbers dialed are stored in the redial list (each 24 digits max.).

- 1 **[▶]** REDIAL
- 2 **[↕]**: Select the desired entry.
- 3 **[↶]**

Erasing a number in the redial list

- 1 **[▶]** REDIAL
- 2 **[↕]**: Select the desired entry. → **[ERASE]**
- 3 **[↕]**: "Yes" → **[OK]** → **[OFF]**

Using the base unit

- 1 Dial the phone number.
 - To correct a digit, press **[CLEAR]**.
- 2 Lift the corded handset.
- 3 When you finish talking, place the corded handset on the cradle.

Note:

- You can also dial the phone number after lifting the corded handset.
- While on a call, you can switch from the base unit to the cordless handset as follows. The privacy mode must be off (page 31).
 - ① **Handset:** Press **[↶]**.
 - ② **Base unit:** Place the corded handset on the cradle. When the speakerphone is used, press **[☎]**.

Using the speakerphone

- 1 During a conversation with the corded handset, press **[☎]** to turn on the speakerphone.
 - You can place the corded handset on the cradle.
 - Speak into the base unit microphone.
- 2 When you finish talking, press **[☎]**.

Note:

- To switch to the receiver, lift the corded handset.

Making a call using the redial list

The last 10 phone numbers dialed are stored in the redial list (each 24 digits max.).

- 1 **[REDIAL]**
- 2 **[↕]**: Select the desired entry.
- 3 Lift the corded handset.

Erasing a number in the redial list

- 1 **[REDIAL]**
- 2 **[↕]**: Select the desired entry. → **[ERASE]**
- 3 **[↕]**: "Yes" → **[OK]** → **[EXIT]**

Adjusting the receiver or speaker volume

Handset

Press **[▲]** or **[▼]** repeatedly while talking.

Base unit

Press **[▲]** or **[▼]** repeatedly while talking.

OR

Press **[AMPLIFIED VOLUME]** repeatedly while talking.

- Each press **[AMPLIFIED VOLUME]**, receiver/speaker volume is increased by several levels.

Pause (for PBX/long distance service users)

A pause is sometimes required when making calls using a PBX or long distance service. When storing a calling card access number and/or PIN in the phonebook, a pause is also needed (page 25).

Example: If you need to dial the line access number "0" when making outside calls with a PBX:

Making/Answering Calls

Handset

- 1 [0] → [▲] (Pause)
- 2 Dial the phone number. → [↶]

Base unit

- 1 [0] → [PAUSE]
- 2 Dial the phone number.
- 3 Lift the corded handset.

Note for handset and base unit:

- A 3 second pause is inserted each time you press [▲] (Pause) on the handset or [PAUSE] on the base unit.

Answering calls

Using the handset

- 1 Lift the handset and press [↶] or [📞] when the unit rings.
- 2 When you finish talking, press [OFF] or place the handset on the charger.

Any key answer: You can answer the call by pressing any dial key.

Auto talk: You can answer calls simply by lifting the handset (page 31).

Temporary ringer off: You can turn the ringer off temporarily by pressing [🔕].

Using the base unit

- 1 Lift the corded handset or press [📞] when the unit rings.
- 2 When you finish talking, place the corded handset on the cradle. When the speakerphone is used, press [📞].

Temporary ringer off: You can turn the ringer off temporarily by pressing [🔕].

Adjusting the ringer volume

Handset

Press [▲] or [▼] repeatedly to select the desired volume while ringing.

Base unit

Press [▲] or [▼] repeatedly to select the desired volume while ringing.

OR

Press [AMPLIFIED VOLUME] repeatedly to select the desired volume while ringing.

- Each press [AMPLIFIED VOLUME], ringer volume is increased by several levels.

Useful features during a call

Hold

Handset

- 1 Press [MENU] during an outside call.
- 2 [↕]: "Hold" → [OK]
- 3 To release hold, press [↶].
 - Another handset user can take the call by pressing [↶].
 - The base unit user can take the call by lifting the corded handset.

Base unit

- 1 Press [HOLD] during an outside call.
 - If you are using the corded handset, you can place it on the cradle.
- 2 To release hold, lift the corded handset.
 - A handset user can take the call by pressing [↶].

Note for handset and base unit:

- While an outside call is on hold, the SP-PHONE indicator flashes.
- After holding for 10 minutes, the call is disconnected.

Mute

Handset / Base unit

- 1 Press [MUTE] during a call.
- 2 To return to the call, press [MUTE].

Note:

- [MUTE] is a soft key visible on the display during a call.

Recall/flash

Handset / Base unit

[RECALL] allows you to use the special features of your host PBX such as transferring an extension call, or accessing optional telephone services.

Note:

- To change the recall/flash time, see page 31.

For call waiting or Call Waiting Caller ID service users

To use call waiting or Call Waiting Caller ID, you must first subscribe with your phone service provider.

This feature allows you to receive calls while you are already talking on the phone. If you receive a call while on the phone, you will hear a call waiting tone.

If you subscribe to both Caller ID and Call Waiting with Caller ID services, the 2nd caller's information is displayed on the handset or base unit that is in use after you hear the call waiting tone.

Handset / Base unit

- 1 Press **[RECALL]** on the handset or **[CALL WAIT]** on the base unit to answer the 2nd call.
- 2 To switch between calls, press **[RECALL]** on the handset or **[CALL WAIT]** on the base unit.

Note:

- Please contact your phone service provider for details and availability of this service in your area.

Handset noise reduction

This feature allows you to hear the voice of the person you are talking to more clearly, by reducing the surrounding noise coming from the other party's telephone.

- 1 Press **[MENU]** while talking.
- 2 **[↕]**: "Noise Reduction On" or "Noise Reduction Off" → **[OK]**

Note:

- Depending on the environment where this handset is being used, this feature may not be effective.

- This feature is not available while using the speakerphone.

Handset equalizer

This feature clarifies the voice of the person you are talking to, producing a more natural-sounding voice that is easier to hear and understand.

- 1 Press **[MENU]** while talking.
- 2 **[↕]**: "Equalizer" → **[OK]**
- 3 **[↕]**: Select the desired setting.
- 4 Press **[OK]** to exit.

Note:

- Depending on the condition and quality of your telephone line, this feature may emphasise existing line noise. If it becomes difficult to hear, turn this feature off.
- This feature is not available while using the speakerphone.

Call share

You can join an existing outside call.

Handset

To join the conversation, press **[↶]** when the other unit is on an outside call.

Base unit

To join the conversation, lift the corded handset when the handset is on an outside call.

Note for handset and base unit:

- To prevent other users from joining your conversations with outside callers, turn the privacy mode on (page 31).

Transferring calls, conference calls

Outside calls can be transferred or a conference call with an outside party can be made:

- between 2 handsets
- between a handset and the base unit

Handset

- 1 During an outside call, press **[↶]**.
When 2 or more handsets are registered:
[↕]: Select the desired unit. → **[OK]**
- 2 Wait for the paged party to answer.
 - If the paged party does not answer, press **[BACK]** to return to the outside call.

Making/Answering Calls

3 To complete the transfer:

Press [OFF].

To establish a conference call:

[MENU] → [↕]: "Conference" → [OK]

- To leave the conference, press [OFF]. The other 2 parties can continue the conversation.
- To put the outside call on hold: [MENU] → [↕]: "Hold" → [OK]
To resume the conference: [MENU] → [↕]: "Conference" → [OK]
- To cancel the conference: [MENU] → [↕]: "Stop Conference" → [OK]
You can continue the conversation with the outside caller.

Base unit

- 1 During an outside call, press [↵].
When 2 or more handsets are registered:
[↕]: Select the desired unit. → [OK]
 - To page all handsets, press [0] or wait for a few seconds.
- 2 Wait for the paged party to answer.
 - If paged party does not answer, press [↵] to return to the outside call.
- 3 **To complete the transfer:**
Place the corded handset on the cradle.
 - The outside call is being routed to the handset.**To establish a conference call:**
Press [CONF].
 - To leave the conference, place the corded handset on the cradle. The other 2 parties can continue the conversation.
 - To put the outside call on hold, press [HOLD]. To resume the conference, press [CONF].

Intercom

Intercom calls can be made:

- between handsets
- between a handset and the base unit

Note:

- When paging unit(s), the paged unit(s) beeps for 1 minute.
- If you receive an outside call while talking on the intercom, the interrupt tone sounds.
 - **Handset:** To finish intercom, press [OFF]. To answer the call, press [↵].

- **Base unit:** To finish intercom, place the corded handset on the cradle. If the speakerphone is used, press [↵]. To answer the call, lift the corded handset. If the speakerphone is used, press [↵].

Making an intercom call

Handset

- 1 [↵]
When 2 or more handsets are registered:
[↕]: Select the desired unit. → [OK]
- 2 When you finish talking, press [OFF].

Base unit

- 1 [↵]
When 2 or more handsets are registered:
[↕]: Select the desired unit. → [OK]
 - To page all handsets, press [0] or wait for a few seconds.
 - Lift the corded handset if needed.
- 2 When you finish talking, press [↵] or place the corded handset on the cradle.

Answering an intercom call

Handset

- 1 Press [↵] to answer the page.
- 2 When you finish talking, press [OFF].

Base unit

- 1 Press [↵] or lift the corded handset to answer the page.
- 2 When you finish talking, press [↵] or place the corded handset on the cradle.

Turning auto intercom on/off

This feature allows the handset and base unit to answer intercom calls automatically when it is called. You do not need to press [↵], lift the corded handset, or press [↵]. When this feature is set to "on", the monitoring handset or base unit for the baby monitor feature (page 36) will also answer baby monitor calls automatically. The default setting is "off".

Handset / Base unit

- 1 [MENU]# [2] [7] [3]

- 2 **[↕]**: Select the desired setting. → **[OK]**
- 3 Proceed with the operation for your unit.
Handset: [OFF]
Base unit: [EXIT]

Key lock

Handset

The handset can be locked so that no calls or settings can be made. Incoming calls can be answered, but all other functions are disabled while key lock is on.

To turn key lock on, press **[MENU]** for about 3 seconds.

- To turn key lock off, press **[*0]** for about 3 seconds.

Note:

- Calls to emergency numbers cannot be made until key lock is turned off.

Nuisance Call Block

Using the call block button

You can press the **[BLOCK]** on the handset or **[CALL BLOCK]** button on the base unit in the following situation to disconnect the current call and add a phone number to the call block list:

- when an incoming call is being received
- when an incoming call is being recorded by the answering system
- when talking on an outside call on the base unit

Once a phone number has been added to the call block list, the unit will block calls from that phone number in the future.

Handset / Base unit

- 1 Press **[BLOCK]** on the handset or **[CALL BLOCK]** on the base unit under the situations shown above.
- 2 Confirm the call block number and press **[YES]**.
 - The call block number is stored in the call block list, "Caller Blocked" is displayed, and then the call is disconnected.

Note:

- If the call has no phone number, the call is blocked but it is not stored in the call block list.
- The call block feature is not available for the calls during call waiting or intercom call.
- Blocked calls are logged in the caller list.

Storing unwanted callers

The unit can block calls by storing the desired items into the call block list beforehand (Caller ID subscribers only).

- "Single Number": The unit blocks calls from specific phone numbers stored in the call block list.
- "Range of Numbers": The unit blocks calls that begin with a number stored in the call block list, such as a toll-free phone number prefix or certain area codes.
- "Withheld": The unit blocks calls that have no phone number.

Single phone numbers and ranges of numbers can be stored in the call block list up to 100 items in total.

Blocking unwanted callers:

When a call is received, the unit does not ring while the caller is being identified.

If the caller's phone number matches an entry in the call block list, the unit emits no sound to the caller, and disconnects the call.

Storing a single phone number

Important:

- You must include the area code when storing phone numbers in the call block list.

Adding call blocked numbers from the caller list

Handset

- 1 **[▼]** CID
- 2 **[↕]**: Select the entry to be blocked. → **[MENU]**
- 3 **[↕]**: "Save Caller ID" → **[OK]**
- 4 **[↕]**: "Nuisance Call Block" → **[OK]**
- 5 **[↕]**: "Yes" → **[OK]** → **[OFF]**

Base unit

- 1 **[CID]**
- 2 **[↕]**: Select the entry to be blocked.
- 3 **[CALL BLOCK]**
- 4 **[↕]**: "Yes" → **[OK]** → **[EXIT]**

Adding call blocked numbers manually

Handset

- 1 **[MENU]** **#** **2** **1** **7**
- 2 **[↕]**: "Single Number" → **[OK]**
- 3 **[MENU]** → **[↕]**: "Add" → **[OK]**
- 4 Enter the phone number (24 digits max.).
- 5 **[OK]** → **[OFF]**

Base unit

- 1 **[CALL BLOCK]**
- 2 **[↕]**: "Single Number" → **[OK]** → **[ADD]**
- 3 Enter the phone number (24 digits max.).
- 4 **[OK]** → **[EXIT]**

Storing a range of number

Handset

- 1 **[MENU]** **#** **2** **1** **7**
- 2 **[↕]**: "Range of Numbers" → **[OK]**

Nuisance Call Block

- 3 [MENU] → [↕]: "Add" → [OK]
- 4 Enter the desired number (2-8 digits).
- 5 [OK] → [OFF]

Base unit

- 1 [CALL BLOCK]
- 2 [↕]: "Range of Numbers" → [OK]
- 3 [ADD]
- 4 Enter the desired number (2-8 digits).
- 5 [OK] → [EXIT]

Blocking incoming calls that have no phone number

You can reject calls when no phone number is provided, such as private callers.

Handset

- 1 [MENU]# [2] [4] [0]
- 2 [↕]: Select the desired setting. → [OK] → [OFF]

Base unit

- 1 [CALL BLOCK]
- 2 [↕]: "Withheld" → [OK]
- 3 [↕]: Select the desired setting. → [OK] → [EXIT]

Viewing/editing/erasing call block numbers

Handset

- 1 [MENU]# [2] [1] [7]
- 2 [↕]: "Single Number" or "Range of Numbers" → [OK]
- 3 [↕]: Select the desired entry.
 - After viewing, press [OFF] to exit.
- 4 **To edit a number:**
[EDIT] → Edit the number. → [OK] → [OFF]

To erase a number:
[ERASE] → [↕]: "Yes" → [OK] → [OFF]

Base unit

- 1 [CALL BLOCK]

- 2 [↕]: "Single Number" or "Range of Numbers" → [OK]
- 3 [↕]: Select the desired entry.
 - After viewing, press [EXIT] to exit.
- 4 **To edit a number:**
[EDIT] → Edit the number. → [OK] → [EXIT]

- To erase a number:**
[ERASE] → [↕]: "Yes" → [OK] → [EXIT]

Note:

- When editing, press the desired dial key to add digits and press [CLEAR] to erase digits.

Erasing all call block numbers

Handset

- 1 [MENU]# [2] [1] [7]
- 2 [↕]: "Single Number" or "Range of Numbers" → [OK]
- 3 [MENU] → [↕]: "Erase All" → [OK]
- 4 [↕]: "Yes" → [OK]
- 5 [↕]: "Yes" → [OK] → [OFF]

Base unit

- 1 [CALL BLOCK]
- 2 [↕]: "Single Number" or "Range of Numbers" → [OK]
- 3 [ERASE]
- 4 [↕]: "Yes" → [OK]
- 5 [↕]: "Yes" → [OK] → [EXIT]

Phonebook

Phonebook

You can add 100 names (16 characters max.) and phone numbers (24 digits max.) to the phonebook, and assign each phonebook entry to the desired category (page 24).

Important:

- All entries can be shared by the base unit and any registered handset.

Adding phonebook entries

Handset / Base unit

- 1 Proceed with the operation for your unit.
Handset: [◀] □□ → [MENU]
Base unit: [□□] → [MENU]
- 2 [↕]: "New Entry" → [OK]
- 3 Enter the party's name. → [OK]
 - You can change the character entry mode by pressing [ECO] on the handset or [1/A/Å] on the base unit (page 49).
- 4 Enter the party's phone number. → [OK]
- 5 [↕]: Select the desired category. → [OK] 2 times
- 6 Proceed with the operation for your unit.
Handset: [OFF]
Base unit: [EXIT]

Note for base unit:

- You can also add entries as follows:
Press [□□]. → [ADD] → Go to step 3.

Storing a redial list number to the phonebook

Handset / Base unit

- 1 Proceed with the operation for your unit.
Handset: [▶] REDIAL
Base unit: [REDIAL]
- 2 [↕]: Select the desired entry. → [SAVE]
- 3 To store the name, continue from step 3, "Editing entries", page 25.

Storing caller information to the phonebook

Handset

- 1 [▼] CID
- 2 [↕]: Select the desired entry. → [MENU]
- 3 [↕]: "Save Caller ID" → [OK]

- 4 [↕]: "Phonebook" → [OK]
- 5 To store the name, continue from step 3, "Editing entries", page 25.

Base unit

- 1 [CID]
- 2 [↕]: Select the desired entry. → [SAVE]
- 3 [↕]: "Phonebook" → [OK]
- 4 To store the name, continue from step 3, "Editing entries", page 25.

Categories

Categories can help you find entries in the phonebook quickly and easily. You can change the names of categories ("Friends", "Family", etc.). By assigning different ringer tones for different categories of callers, you can identify who is calling (category ringer tone), if you have subscribed to Caller ID service.

Changing category names/setting category ringer tone

Handset / Base unit

- 1 Proceed with the operation for your unit.
Handset: [◀] □□ → [MENU]
Base unit: [□□] → [MENU]
- 2 [↕]: "Category" → [OK]
- 3 [↕]: Select the desired category. → [OK]
- 4 **To change category names**
[↕]: "Category Name" → [OK] → Edit the name (10 characters max.). → [OK]
To set category ringer tone (handset)
[↕]: Select the current setting of the category ringer tone. → [OK] → [↕]: Select the desired ringer tone. → [OK]
- 5 Proceed with the operation for your unit.
Handset: [OFF]
Base unit: [EXIT]

Finding and calling from a phonebook entry

Handset / Base unit

- 1 Proceed with the operation for your unit.
Handset: [◀] □□
Base unit: [□□]

2 To scroll through all entries

[↕]: Select the desired entry.

To search by first character

- ① Press the dial key ([0] to [9], or [#]) which contains the character you are searching for (page 49).
- ② [↕]: Scroll through the phonebook if necessary.

To search by category

- ① [SEARCH] → [↕]: "Category" → [OK]
- ② [↕]: Select the desired category. → [OK]
- ③ [↕]: Scroll through the phonebook if necessary.

3 Proceed with the operation for your unit.

Handset: [↵]

Base unit: Lift the corded handset.

Editing entries

Handset

- 1 Find the desired entry (page 24). → [MENU]
- 2 [↕]: "Edit" → [OK]
- 3 Edit the name if necessary. → [OK]
- 4 Edit the phone number if necessary. → [OK]
- 5 [↕]: Select the desired category (page 24). → [OK] 2 times → [OFF]

Base unit

- 1 Find the desired entry (page 24).
- 2 [EDIT]
- 3 Edit the name if necessary. → [OK]
- 4 Edit the phone number if necessary. → [OK]
- 5 [↕]: Select the desired category (page 24). → [OK] 2 times → [EXIT]

Erasing entries

Erasing an entry

Handset

- 1 Find the desired entry (page 24). → [MENU]
- 2 [↕]: "Erase" → [OK]
- 3 [↕]: "Yes" → [OK] → [OFF]

Base unit

- 1 Find the desired entry (page 24).
- 2 [ERASE] → [↕]: "Yes" → [OK] → [EXIT]

Erasing all entries

Handset / Base unit

- 1 Proceed with the operation for your unit.
Handset: [←] □□ → [MENU]
Base unit: [□□] → [MENU]
- 2 [↕]: "Erase All" → [OK]
- 3 [↕]: "Yes" → [OK]
- 4 [↕]: "Yes" → [OK]
- 5 Proceed with the operation for your unit.
Handset: [OFF]
Base unit: [EXIT]

Chain dial

This feature allows you to dial phone numbers in the phonebook while you are on a call. This feature can be used, for example, to dial a calling card access number or bank account PIN that you have stored in the phonebook, without having to dial manually.

Handset / Base unit

- 1 Proceed with the operation for your unit.
Handset: During an outside call, press [←] □□.
Base unit: During an outside call, press [□□].
- 2 [↕]: Select the desired entry.
- 3 Press [CALL] to dial the number.

Note:

- When storing a calling card access number and your PIN in the phonebook as one phonebook entry, press [▲] (Pause) on the handset or [PAUSE] on the base unit to add pauses after the number and PIN as necessary (page 17).

Speed dial

You can store phone numbers to the base unit and handset separately:

- Handset: up to 9 entries.
- Base unit: up to 9 entries.

Phonebook

Adding phone numbers to speed dial keys

Handset

You can assign 1 phone number to each of the dial keys ([1] to [9]).

■ By entering phone numbers:

- 1 Press and hold the desired speed dial key ([1] to [9]). → **[ADD]**
- 2 [↕]: "Manual" → **[OK]**
- 3 Enter the party's name (16 characters max.). → **[OK]**
- 4 Enter the party's phone number (24 digits max.). → **[OK]** 2 times → **[OFF]**

■ From the phonebook:

- 1 Press and hold the desired speed dial key ([1] to [9]). → **[ADD]**
- 2 [↕]: "Phonebook" → **[OK]**
- 3 [↕]: Select the desired entry.
- 4 **[OK]** → **[OFF]**

Base unit

■ By entering phone numbers:

- 1 **[SPEED DIAL]**
- 2 [↕]: Select the desired speed dial key. → **[EDIT]**
- 3 Enter the party's name (16 characters max.). → **[OK]**
- 4 Enter the party's phone number (24 digits max.). → **[OK]** 2 times → **[EXIT]**

■ From the phonebook:

- 1 **[SPEED DIAL]**
- 2 [↕]: Select the desired speed dial key. → **[□□]**
- 3 [↕]: Select the desired entry.
- 4 **[OK]** → **[EXIT]**

Note for handset and base unit:

- If you edit a phonebook entry which is assigned to a speed dial key, the edited entry does not transfer to the speed dial key.

Note for base unit:

- You can also select the desired entry as follows:

- Press and hold the desired speed dial key ([1] to [9]).
- Press **[SPEED DIAL]** and then enter the desired speed dial key ([1] to [9]).

Editing an entry

Handset

- 1 Press and hold the desired speed dial key ([1] to [9]). → **[MENU]**
- 2 [↕]: "Edit" → **[OK]**
- 3 Edit the name if necessary. → **[OK]**
- 4 Edit the phone number if necessary. → **[OK]** 2 times → **[OFF]**

Base unit

- 1 **[SPEED DIAL]**
- 2 [↕]: Select the desired entry. → **[DETAIL]**
- 3 **[EDIT]**
- 4 Edit the name if necessary. → **[OK]**
- 5 Edit the phone number if necessary. → **[OK]** 2 times → **[EXIT]**

Erasing an entry

Handset

- 1 Press and hold the desired speed dial key ([1] to [9]). → **[MENU]**
- 2 [↕]: "Erase" → **[OK]**
- 3 [↕]: "Yes" → **[OK]** → **[OFF]**

Base unit

- 1 **[SPEED DIAL]**
- 2 [↕]: Select the desired entry. → **[DETAIL]**
- 3 **[ERASE]**
- 4 [↕]: "Yes" → **[OK]** → **[EXIT]**

Viewing an entry/Making a call

Handset

- 1 Press and hold the desired speed dial key ([1] to [9]).
- 2 To make a call, press [↶].

Base unit

- 1 **[SPEED DIAL]**

- 2 [↕]: Select the desired entry.
- 3 Lift the corded handset.

Note for base unit:

- You can dial phone numbers in the speed dial while you are on a call.

One-touch dial buttons

You can store phone numbers to the base unit's one-touch dial buttons ([I] to [III]).

Adding phone numbers for outside calls

Base unit

■ **By entering phone numbers:**

- 1 Press and hold the desired one-touch dial button ([I] to [III]). → [EDIT]
- 2 Enter the party's name (16 characters max.). → [OK]
- 3 Enter the party's phone number (24 digits max.). → [OK] 2 times → [EXIT]

■ **From the phonebook:**

- 1 Press and hold the desired one-touch dial button ([I] to [III]).
- 2 [□□]
- 3 [↕]: Select the desired entry.
- 4 [OK] → [EXIT]

Note:

- If you edit a phonebook entry which is assigned to a one-touch dial button, the edited entry does not transfer to the one-touch dial button.

Viewing/editing/erasing an entry

Base unit

- 1 Press and hold the desired one-touch dial button ([I] to [III]).
 - After viewing, press [EXIT] to exit.
- 2 **To edit an entry**
 [EDIT] → Edit the name if necessary. → [OK] → Edit the phone number if necessary. → [OK] 2 times → [EXIT]
To erase an entry
 [ERASE] → [↕]: "Yes" → [OK] → [EXIT]

Making a call

Base unit

Press the desired one touch dial button ([I] to [III]), then lift the corded handset.

Note:

- You can dial phone numbers in the one-touch dial while you are on a call.

Programming

Menu list

To access the features, there are 2 methods.

Handset / Base unit

■ Scrolling through the display menus

- 1 [MENU]
- 2 **Handset:** Press [▼], [▲], [▶], or [◀] to select the desired main menu. → [OK]
Base unit: Press [▼], [▲], [▶▶], or [◀◀] to select the desired main menu. → [OK]
- 3 Press [▼] or [▲] to select the desired item from the next sub-menus. → [OK]
- 4 Press [▼] or [▲] to select the desired setting. → [OK]

■ Using the direct command code

- 1 [MENU] → Enter the desired code.
Example: Press [MENU]#101.
- 2 Select the desired setting. → [OK]

Note:

- The unit column shows the unit(s) that can be used to program the item.
 - 📞: Only the handset can program the item.
 - 📠: Only the base unit can program the item.
 - 📞/📠: Both the handset and base unit can program the item.
- To exit the operation, press [OFF] on the handset or [EXIT] on the base unit.
- In the following table, < > indicates the default settings.
- In the following table, 📖 indicates the reference page number.
- Display menu order and sub-menu may vary depending on your model.

Display the menu tree and direct command code table









Main menu:

Handset: 00 "Answer System"



Base unit: 00📞 "Answer System"

Sub-menu 1	Sub-menu 2	Settings	Code	Unit	📖
Play New Message	–	–	#323	📞	43
Play All Message	–	–	#324	📞	43
Erase All Message*1	–	–	#325	📞	43
Greeting	Record Greeting*1	–	#302	📞/📠	41
	Play Greeting	–	#303	📞/📠	42
	Default*1 (Reset to pre-recorded greeting)	–	#304	📞/📠	41

Programming

Sub-menu 1	Sub-menu 2	Settings	Code	Unit	👉
New Message Alert ^{*1}	Outgoing Call – On/Off	On <Off>	#338		43
	Outgoing Call – Notification to	–			
	Outgoing Call – Remote Code	Activate <Inactivate>			
	Base Unit Beep	On <Off>	#339		43
Settings	Number of Rings ^{*1}	2-9 Rings <8 Rings> Auto	#211		46
	Recording Time ^{*1}	1 Minute <3 Minutes> Greeting Only ^{*2}	#305		47
	Remote Code ^{*1}	–	#306		45
	Call Screening	<On> Off	#310		46
Answer On ^{*1}	–	–	#327		41
Answer Off ^{*1}	–	–	#328		41

Main menu: ☹ “Time Settings”

























Sub-menu 1	Sub-menu 2	Settings	Code	Unit	👉
Set Date/Time ^{*1}	–	–	#101		15
Memo Alarm	Alarm1-3	Once Daily Weekly <Off>	#720		33
Time Adjustment ^{*1, *3}	–	<Caller ID> Manual	#226		–

Main menu: ➔ “Caller List”































Operation	Code	Unit	👉
Viewing the caller list.	#213		39

Programming







Main menu:  "Initial Setup"

Sub-menu 1	Sub-menu 2	Settings	Code	Unit	
Ringer Setup	Ringer Volume	Off-6 <6>	#160	 	-
	Ringtone* ⁴ (Handset)	<Ringtone 1>	#161		-
	Do Not Disturb Mode - On/Off	On <Off>	#238	 	34
	Do Not Disturb Mode - Start/End	<23:00/06:00>	#237	 	34
	Do Not Disturb Mode - Ring Delay	30 sec. <60 sec.> 90 sec. 120 sec. No Ringing	#239	 	34
	Do Not Disturb Mode - Select Category	Category 1-9	#241	 	34
	First Ring* ¹ , * ⁵	<On> Off	#173	 	-
Time Settings	Set Date/Time* ¹	-	#101	 	15
	Memo Alarm - Alarm 1-3	Once Daily Weekly <Off>	#720		33
	Time Adjustment* ¹ , * ³	<Caller ID> Manual	#226	 	-
Talking Caller ID	-	<On> Off	#162	 	39
Key Finder Setup* ⁶ - 1:Add New Device (for Finder1) ⁷ - 2:Add New Device (for Finder2) - 3:Add New Device (for Finder3) - 4:Add New Device (for Finder4)	Change Name* ¹	Finder1	#6561		-
		Finder2* ⁸	#6562* ⁸		
		Finder3* ⁸	#6563* ⁸		
		Finder4* ⁸	#6564* ⁸		
	Register	-	#6571		-
			#6572* ⁸		
			#6573* ⁸		
			#6574* ⁸		
	Cancel Register	-	#6581		-
			#6582* ⁸		
			#6583* ⁸		
			#6584* ⁸		



Programming

Sub-menu 1	Sub-menu 2	Settings	Code	Unit	
Nuisance Call Block ^{*1}	Single Number	–	#217	 	22
	Range of Numbers	–			
	Withheld	On <Off>	#240	 	23
One Touch Dial	–	–	#247		27
Speed Dial	–	–	#261	 	25
Eco Mode ^{*1, *9}	–	<Off> Eco Eco Plus	#725	 	16
Security ^{*1, *9}	–	<Normal> Enhanced	#729	 	37
Record Greeting ^{*1}	–	–	#302	 	41
Display Setup	LCD & Key Backlight	<On> Off	#276		–
	Contrast (Display contrast)	Level 1-4 <2>	#145		–
	Handset Name	–	#104		36
	Display Name	On <Off>	#105		36
Contrast (Display contrast)	–	Level 1-6 <3>	#145		–
Auto Intercom	–	On <Off>	#273	 	20
Keytones	–	<On> Off	#165		–
Call Restrict ^{*1}	–	–	#256	 	36
Auto Talk ^{*10}	–	On <Off>	#200		18
Line Setup	Recall/Flash ^{*1, *11}	900 msec. 700 msec. 600 msec. 400 msec. 300 msec. 250 msec. 200 msec. 160 msec. 110 msec. <100 msec.> 90 msec. 80 msec.	#121	 	19
Privacy Mode ^{*1, *12}	–	On <Off>	#194	 	–
Base Unit PIN ^{*1}	–	<0000>	#132	 	37



Programming

Sub-menu 1	Sub-menu 2	Settings	Code	Unit	👍
Repeater Mode*1	–	On <Off>	#138		38
Register	Register Handset	–	#130		37
	Cancel Register*2	–	#131		38
Cancel Register*2	–	–	#131		38
Battery Saving Mode	–	On <Off>	#150		12
Language	Display	<English>	#110		15







Main menu: ☺ “Baby Monitor”*13

Sub-menu 1	Sub-menu 2	Settings	Code	Unit	👍
On/Off	–	On <Off>	#268		35
Sensitivity Level	–	Low <Middle> High	#269		36

Main menu: Ⓜ “Key Finder”*6, *13

Sub-menu 1	Sub-menu 2	Settings	Code	Unit	👍
Search	–	–	#655		–
Battery Check	–	–			

Main menu: 🎵 “Ringer Setup”*14

Sub-menu 1	Sub-menu 2	Settings	Code	Unit	👍
Ringer Volume	–	Off-6 <6>	#160		–
Ringtone	–	<Ringtone 1>	#161		–
Do Not Disturb Mode	On/Off	On <Off>	#238		34
	Start/End	<23:00/06:00>	#237		34
	Ring Delay	30 sec. <60 sec.> 90 sec. 120 sec. No Ringing	#239		34
	Select Category	Category 1-9	#241		34
First Ring	–	<On> Off	#173		–

Main menu: 🗨 “Contrast”*15

Sub-menu 1	Sub-menu 2	Settings	Code	Unit	👍
–	–	Level 1-6 <3>	#145		–

- *1 If you program these settings using one of the units, you do not need to program the same item using another unit.
- *2 This menu is not displayed when scrolling through the display menus. It is only available in direct command code.
- *3 This feature allows the unit to automatically adjust the date and time each time caller information including date and time is received.
To turn this feature on, select “**Caller ID**”. To turn this feature off, select “**Manual**”. (Caller ID subscribers only)
To use this feature, set the date and time first (page 15).
- *4 The preset melodies in this product (“**Ringtone 3**” - “**Ringtone 40**”) are used with permission of © 2012 Copyrights Vision Inc.
- *5 If you do not want the unit to ring before the caller information is received, set to “**off**”. (Caller ID subscribers only)
You can only remove the first ring if the unit rings 2 times or more by default, which depends on your phone service provider.
- *6 This setting is available when you have the key finder (KX-TGA20EX). Read the installation manual for more information on the key finder.
- *7 For models with supplied key finders, the display shows “**1:Finder1**”.
- *8 If you register 2 or more key finders.
- *9 This menu is not displayed when repeater mode is set to “**On**”.
- *10 If you subscribe to a Caller ID service and want to view the caller’s information after lifting up the handset to answer a call, turn off this feature.
- *11 The recall/flash time depends on your telephone exchange or host PBX. Contact your PBX supplier if necessary.
- *12 To prevent other users from joining your conversations with outside callers, turn this feature on.
- *13 Handset only
- *14 This menu icon is displayed when the key finder is not registered.
- *15 Base unit only

Alarm

An alarm sounds at the set time for 1 minute and is repeated 5 times at 5 minute intervals (snooze function). A text memo can also be displayed for the alarm. A total of 3 separate alarm times can be programmed for each handset. You can set one of 3 different alarm options (once, daily, or weekly) for each alarm time.

Important:

- Make sure the unit’s date and time setting is correct (page 15).

Handset

- 1 **[MENU]** **#** **7** **2** **0**
- 2 **[↕]**: Select the desired alarm. → **[OK]**
- 3 **[↕]**: Select the desired alarm option. → **[OK]**

off

Turns alarm off. Go to step 9.

Once

An alarm sounds once at the set time.

Daily

An alarm sounds daily at the set time. Go to step 5.

Weekly

Alarm sounds weekly at the set time(s).

- 4 Proceed with the operation according to your selection in step 3.

■ Once:

Enter the desired date and month. → **[OK]**

■ Weekly:

[↕]: Select the desired day of the week and press **[SELECT]**. → **[OK]**

- 5 Set the desired time. → **[OK]**
- 6 Enter a text memo (10 characters max.). → **[OK]**

Programming

- 7 **[↕]**: Select the desired alarm tone. → **[OK]**
 - We recommend selecting a different ringer tone from the one used for outside calls.
- 8 **[↕]**: Select the desired snooze setting. → **[OK]**
- 9 **[OK]** → **[OFF]**

Note:

- Press **[STOP]** to stop the alarm completely.
- When the handset is in use, the alarm will not sound until the handset is in standby mode.
- Press any dial key or **[SNOOZE]** to stop the sound but keep the snooze function activated.
- If you want to make an outside call when the snooze function is activated, please stop the snooze function before making the call.

Do not disturb mode

Do not disturb mode allows you to select a period of time during which the handset will not ring for outside calls. This feature is useful for time periods when you do not want to be disturbed, for example, while sleeping. Do not disturb mode can be set for each handset. Using the phonebook's category feature (page 24), you can also select categories of callers whose calls override do not disturb mode and ring the handset (Caller ID subscribers only).

Important:

- Make sure the unit's date and time setting is correct (page 15).
- If you have set the alarm, the alarm sounds even if do not disturb mode is turned on.

Turning do not disturb mode on/off

Handset / Base unit

- 1 **[MENU]****[#]****[2]****[3]****[8]**
- 2 **[↕]**: Select the desired setting. → **[OK]**
 - If you select "oFF", press **[OFF]** on the handset or **[EXIT]** on the base unit to exit.
- 3 Enter the desired hour and minute you wish to start this feature. → **[OK]**
- 4 Enter the desired hour and minute you wish to end this feature. → **[OK]**
- 5 Proceed with the operation for your unit.
Handset: [OFF]
Base unit: [EXIT]

Changing the start and end time

Handset / Base unit

- 1 **[MENU]****[#]****[2]****[3]****[7]**
- 2 Continue from step 3, "Turning do not disturb mode on/off", page 34.

Setting the ring delay

This setting allows the handset to ring during do not disturb mode if the caller waits long enough. After the selected amount of time passes, the handset rings. If you select "No Ringing", the handset never rings during do not disturb mode.

Handset / Base unit

- 1 **[MENU]****[#]****[2]****[3]****[9]**
- 2 **[↕]**: Select the desired setting. → **[OK]**
- 3 Proceed with the operation for your unit.
Handset: [OFF]
Base unit: [EXIT]

Note:

- When the answering system answers the call, this feature does not work.

Selecting categories to bypass do not disturb mode

Handset / Base unit

- 1 **[MENU]****[#]****[2]****[4]****[1]**
- 2 **[↕]**: Select the desired category. → **[SELECT]**
 - "✓" is displayed next to the selected category numbers.
 - To cancel the selected category: **[↕]**: Select the category. → Press **[SELECT]** again. "✓" disappears.
- 3 **[OK]**
- 4 Proceed with the operation for your unit.
Handset: [OFF]
Base unit: [EXIT]

Baby monitor

This feature allows you to listen in on a room where another handset is located, allowing you to easily monitor from different areas of the house or place. The monitored handset (placed in a baby's room, for example) will automatically call the

monitoring handset, base unit, or the phone number stored when it detects sound.

Important:

- You should perform a test run of the baby monitor procedure to ensure that the baby monitor feature is set correctly. For example, test its sensitivity. Check the connection if you are diverting the baby monitor to an outside line.
- This feature should not be used as a substitute for a medical or caregiver's supervision. It is the caregiver's responsibility to stay close enough to handle any eventuality.

Note:

- If the unit is connected to a PBX system, you cannot set the baby monitor.
- During the monitoring mode, battery consumption is faster than usual. We recommend leaving the monitored handset on the charger.
- The monitored handset never rings while it is being monitored.
If the base unit is placed near the monitored handset, turn off the base unit ringer volume (page 30).

Setting the baby monitor

Perform the setting operation with the handset to be monitored (for example, the handset placed in a baby's room).

To monitor with a unit

- The internal baby monitor feature is available:
- between handsets
 - between a handset and the base unit

Handset

- 1 **[MENU]** **#** **2** **6** **8**
- 2 **[↕]**: "On" → **[OK]**
- 3 **[↕]**: Select the desired unit's number to monitor with. → **[OK]**
 - "Baby Monitor" will be displayed.
 - The registered unit's name/number is displayed.

Note:

- When this feature is on, another handset or base unit can hear the monitored handset by making an intercom call.

To monitor from an outside line

If you enable this feature, the unit will call a pre-programmed phone number when the handset detects sound. After you answer the call, you can listen in on the room where the handset is located.

■ **From the phonebook:**

- 1 **[MENU]** **#** **2** **6** **8**
- 2 **[↕]**: "On" → **[OK]**
- 3 **[↕]**: Select "External" to monitor from an outside line. → **[EDIT]** → **[ADD]**
- 4 **[↕]**: "Phonebook" → **[OK]**
- 5 **[↕]**: Select the phonebook entry. → **[OK]**
 - "Baby Monitor" will be displayed.

Note:

- If you edit a phonebook entry which is assigned for monitoring, the edited entry does not transfer to the monitor.

■ **By entering phone numbers:**

- 1 **[MENU]** **#** **2** **6** **8**
- 2 **[↕]**: "On" → **[OK]**
- 3 **[↕]**: Select "External" to monitor from an outside line. → **[EDIT]** → **[ADD]**
- 4 **[↕]**: "Manual" → **[OK]**
- 5 Enter the desired name. → **[OK]**
- 6 Enter the desired number. → **[OK]** 2 times
 - "Baby Monitor" will be displayed.

Note:

- The registered name/number is displayed.

Turning off the baby monitor

The monitored handset cannot be used while baby monitor is set to "On".

Handset

- 1 Press **[MENU]** on the handset being monitored.
- 2 **[↕]**: "On/Off" → **[OK]**
- 3 **[↕]**: "Off" → **[OK]** → **[OFF]**

Editing an outside monitoring number

Handset

- 1 Press **[MENU]** on the handset being monitored.
- 2 **[↕]**: "On/Off" → **[OK]**

Programming

- 3 [↕]: "On" → [OK]
- 4 [↕]: Select the outside line. → [EDIT]
- 5 [MENU] → [↕]: "Edit" → [OK]
- 6 Edit the name if necessary. → [OK]
- 7 Edit the phone number if necessary. → [OK]
2 times

Erasing an outside monitoring number

Handset

- 1 Press [MENU] on the handset being monitored.
- 2 [↕]: "On/Off" → [OK]
- 3 [↕]: "On" → [OK]
- 4 [↕]: Select the outside line. → [EDIT]
- 5 [MENU] → [↕]: "Erase" → [OK]
- 6 [↕]: "Yes" → [OK] → [OFF]

Baby monitor sensitivity

You can adjust the sensitivity of the baby monitor. Increase or decrease the sensitivity to adjust the sound level needed to trigger the baby monitor feature.

- This feature cannot be set during a monitoring call.

Handset

- 1 Press [MENU] on the handset being monitored.
- 2 [↕]: "Sensitivity Level" → [OK]
- 3 [↕]: Select the desired setting. → [OK] → [OFF]

Answering the baby monitor

■ When monitoring with a unit:

Handset: Press [↶] to answer a call.

Base unit: Press [↶] to answer a call.

If you want to respond from the monitoring unit, press [MUTE].

- The monitoring unit will answer calls automatically when the auto intercom feature is set to "On" (page 20).

Note:

- If you receive an outside call when communicating with the monitored handset, the interrupt tone sounds.
 - To answer the call with the handset, press [OFF], then press [↶].

– To answer the call with the base unit, press [↶] 3 times.*1

*1 If [MUTE] is pressed, press [↶] 2 times.

■ When monitoring from an outside line:

Answer the call.

If you want to respond from the monitoring phone, press [#]1 using tone dialling.

You can turn off the baby monitor feature by pressing [#]0.

Note:

- The unit disconnects the call automatically after 2 minutes.

Other programming

Changing the handset name

The default handset name is "Handset 1" to "Handset 6". You can customise the name of each handset ("Bob", "Kitchen", etc.). This is useful when you make intercom calls between handsets.

To display the handset name in standby mode, turn on the handset name display feature (page 36).

Handset

- 1 [MENU] [#]104
- 2 Enter the desired name (10 characters max.).
- 3 [OK] → [OFF]

Displaying the handset name

You can select whether or not the handset name is displayed in standby mode. The default setting is "off".

Handset

- 1 [MENU] [#]105
- 2 [↕]: Select the desired setting. → [OK] → [OFF]

Call restriction

You can restrict selected units from dialling certain numbers. You can assign up to 6 phone numbers to be restricted, and select which units are to be restricted. Storing area codes here prevents the

restricted units from dialling any phone number in that area code.

Handset / Base unit

- 1 **[MENU]** **#** **2** **5** **6**
- 2 Enter the base unit PIN (default: "0000").
 - If you forget your PIN, see page 52.
- 3 **[↕]**: Selected the desired units to be restricted. → **[SELECT]**
 - "✓" is displayed next to the selected numbers.
 - To cancel the selected unit: **[↕]**: Select the unit. → Press **[SELECT]** again. "✓" disappears.
- 4 **[OK]**
- 5 Select a memory location by pressing **1** to **6**. → **[OK]**
- 6 Enter the phone number or area code to be restricted (8 digits max.). → **[OK]**
- 7 Proceed with the operation for your unit.
Handset: [OFF]
Base unit: [EXIT]

Enhancing security for phone calls

You can increase the security of phone conversations by setting this feature to "Enhanced". When "Enhanced" is selected,  is displayed. The default setting is "Normal".

Handset / Base unit

- 1 **[MENU]** **#** **7** **2** **9**
- 2 **[↕]**: Selected the desired setting. → **[OK]**
- 3 Proceed with the operation for your unit.
Handset: [OFF]
Base unit: [EXIT]

Note:

- If you set repeater mode to "On" (page 38):
 - Security is set to "Normal" and  is displayed.
 - "Security" is not displayed in the display menu (page 31).
- When enhanced security is enabled, sound may cut in and out during conversations.

Changing the base unit PIN

Important:

- If you change the PIN (Personal Identification Number), please make note of your new PIN. The unit will not reveal the PIN to you. If you forget your PIN, see page 52.

Handset / Base unit

- 1 **[MENU]** **#** **1** **3** **2**
- 2 Enter the current 4-digit base unit PIN (default: "0000").
- 3 Enter the new 4-digit base unit PIN. → **[OK]**
- 4 **[↕]**: "Yes" → **[OK]**
- 5 Proceed with the operation for your unit.
Handset: [OFF]
Base unit: [EXIT]

Registering a unit

Operating additional units

Additional handsets

Up to 6 handsets can be registered to the base unit.

Important:

- The additional handset model recommended for use with this unit is noted on page 4. If another handset model is used, certain operations may not be available.

Registering a handset to the base unit

The supplied handset and base unit are pre-registered. If for some reason the handset is not registered to the base unit (for example,  is displayed even when the handset is near the base unit), re-register the handset.

- 1 **Handset:**
[MENU] **#** **1** **3** **0**
- 2 **Base unit:**
 Press and hold **[*]** for about 5 seconds.
 - If all registered handsets start ringing, press **[*]** again to stop, then repeat this step.

Programming

3 Handset:

- [OK] → Wait until “**Base PIN**” is displayed.
- Enter the base unit PIN (default: “0000”).
- [OK]
- If you forget your PIN, see page 52.

Deregistering a handset

A handset can cancel its own registration to the base unit, or other handsets registered to the same base unit. This allows the handset to end its wireless connection with the system.

Handset / Base unit

- 1 [MENU][#][1][3][1]
 - All handsets registered to the base unit are displayed.
- 2 [↕]: Select the handset you want to cancel.
→ [OK]
- 3 [↕]: “Yes” → [OK]
- 4 Proceed with the operation for your unit.
Handset: [OFF]
Base unit: [EXIT]

Increasing the range of the base unit

You can increase the signal range of the base unit by using a DECT repeater. Please use only the Panasonic DECT repeater noted on page 3. Contact your Panasonic dealer for details.

Important:

- Before registering the repeater to this base unit, you must turn the repeater mode on.
- Do not use more than one repeater at a time.

Setting the repeater mode

Handset / Base unit

- 1 [MENU][#][1][3][8]
- 2 [↕]: Select the desired setting. → [OK]
- 3 Proceed with the operation for your unit.
Handset: [OFF]
Base unit: [EXIT]

Registering the DECT repeater (KX-A405/ KX-A406) to the base unit

Note:

- Please use a repeater that has not yet been registered to another unit. If the repeater is registered to another unit, deregister it first,

referring to the Installation Guide for the DECT repeater.

1 Base unit:

Press and hold [↕] for about 5 seconds.

2 DECT repeater:

Connect the AC adaptor, then wait until the ⓘ indicator and ∇ indicator light green.

3 Base unit:

To exit the registration mode, press [↕].

Using Caller ID service

Important:

- This unit is Caller ID compatible. To use Caller ID features, you must subscribe to a Caller ID service. Contact your phone service provider for details.

Caller ID features

Handset / Base unit

When an outside call is being received, the caller information is displayed.

Caller information for the last 50 callers is logged in the caller list from the most recent call to the oldest.

- If the unit cannot receive caller information, the following is displayed:
 - “**Out of Area**”: The caller dials from an area which does not provide a Caller ID service.
 - “**Private Caller**”: The caller requests not to send caller information.
- If the unit is connected to a PBX system, caller information may not be properly received. Contact your PBX supplier.

Missed calls

Handset / Base unit

If a call is not answered, the unit treats it as a missed call and **↔** is displayed. This lets you know if you should view the caller list to see who called while you were away.

Even if only one missed call in the caller list is viewed (page 39), **↔** disappears from the display. When you receive another new call, **↔** is displayed again.

Note:

- Even when there are unviewed missed calls, **↔** disappears from the standby display if the following operation is performed by one of the registered handsets:
 - A handset is replaced on the charger.
 - Pressing **[OFF]** on a handset.
 - Pressing **[EXIT]** on the base unit.

Phonebook name display

When caller information is received and it matches a phone number stored in the phonebook, the

stored name in the phonebook is displayed and logged in the caller list.

Talking Caller ID

Handset / Base unit

This feature let you know who is calling by announcing the caller information.

To use this feature, you must:

- subscribe to a Caller ID service of your phone service provider.
- turn this feature on (page 30).
- store the name and phone number in the phonebook (page 24).

Phonebook name announcement

When caller information is received from your phone service provider and it matches a phone number stored in the phonebook, the stored name is announced following every ring.

If that phone number has not been stored in the phonebook, the caller information is announced.

Note:

- Name pronunciation may vary. This feature may not pronounce all names correctly.

Caller list

Important:

- Make sure the unit's date and time setting is correct (page 15).

Viewing the caller list and calling back

Handset / Base unit

- 1 Proceed with the operation for your unit.
Handset: **[▼]** CID
Base unit: **[CID]**
- 2 Press **[▼]** to search from the most recent call, or press **[▲]** to search from the oldest call.
- 3 Proceed with the operation for your unit.
Handset:
 - To call back, press **[↶]**.
 - To exit, press **[OFF]**.**Base unit:**
 - To call back, lift the corded handset.
 - To exit, press **[EXIT]**.

Caller ID Service

Note:

- If the entry has already been viewed or answered, "✓" is displayed.

Editing a caller's phone number

Handset

- 1 [▼] CID
- 2 [↕]: Select the desired entry. → [MENU]
- 3 [↕]: "Edit & Call" → [OK]
- 4 Edit the number.
- 5 [↶]

Base Unit

- 1 [CID]
- 2 [↕]: Select the desired entry. → [EDIT]
- 3 Edit the number.
- 4 Lift the corded handset.

Erasing selected caller information

Handset / Base Unit

- 1 Proceed with the operation for your unit.
Handset: [▼] CID
Base unit: [CID]
- 2 [↕]: Select the desired entry.
- 3 [ERASE] → [↕]: "Yes" → [OK]
- 4 Proceed with the operation for your unit.
Handset: [OFF]
Base unit: [EXIT]

Erasing all caller information

Handset / Base Unit

- 1 Proceed with the operation for your unit.
Handset: [▼] CID
Base unit: [CID]
- 2 [ERASE] → [↕]: "Yes" → [OK]
- 3 Proceed with the operation for your unit.
Handset: [OFF]
Base unit: [EXIT]

Answering system

The answering system can answer and record calls for you when you are unavailable to answer the phone.

You can also set the unit to play a greeting message but not to record caller messages by selecting “**Greeting Only**” as the recording time setting (page 47).

Important:

- Make sure the unit’s date and time setting is correct (page 15).

Memory capacity (including your greeting message)

The total recording capacity is about 40 minutes. A maximum of 64 messages can be recorded.

Note:

- When message memory becomes full:
 - “**Messages Full**” is shown on the handset and base unit display.
 - The ANSWER ON/OFF indicator (📞) on the base unit flashes rapidly if the answering system is turned on.
 - 📞 and the total number of new messages are not displayed even if the answering system is turned on.
 - If you use the pre-recorded greeting message, the unit automatically switches to another pre-recorded greeting message asking callers to call again later.
 - If you recorded your own greeting message, the same message is still announced to callers even though their messages are not recorded.

Turning the answering system on/off

The answering system is preset to on.

Base unit

Press [📞] to turn on/off the answering system.

Handset

- 1 **To turn on:**
[MENU][#][3][2][7]

- To turn off:**
[MENU][#][3][2][8]

2 [OFF]

Note for base unit and handset:

- When the answering system is turned on:
 - the ANSWER ON/OFF indicator (📞) on the base unit lights up.
 - 📞 is displayed on the handset.

Greeting message

When the unit answers a call, a greeting message is played to callers.

You can use either:

- your own greeting message
- a pre-recorded greeting message

Recording your greeting message

You can configure this setting using either the base unit or one of the handsets.

Handset / Base Unit

- 1 [MENU][#][3][0][2]
- 2 [↕]: “**Yes**” → [OK]
- 3 After a beep sounds, speak clearly about 20 cm away from the microphone (2 minutes and 30 seconds max.).
- 4 Press [STOP] to stop recording.
- 5 Proceed with the operation for your unit.
Handset: [OFF]
Base unit: [EXIT]

Using a pre-recorded greeting message

The unit provides 2 pre-recorded greeting messages:

- If you erase or do not record your own greeting message, the unit plays a pre-recorded greeting asking callers to leave a message.
- If the message recording time (page 47) is set to “**Greeting Only**”, callers’ messages are not recorded and the unit plays a different pre-recorded greeting message asking callers to call again.

Resetting to a pre-recorded greeting message

If you change into a pre-recorded greeting message once you record your own greeting

Answering System

message, your own recorded greeting message is erased.

You can configure this setting using either the base unit or one of the handsets.

Handset / Base Unit

- 1 [MENU]#304
- 2 [OK]
- 3 Proceed with the operation for your unit.
Handset: [OFF]
Base unit: [EXIT]

Playing back the greeting message

Handset / Base Unit

- 1 [MENU]#303
- 2 Proceed with the operation for your unit.
Handset: [OFF]
Base unit: [EXIT]

Listening to messages

Important:

- If your phone service provider offers voicemail service, the voicemail service may answer calls before the base unit's built-in answering system has a chance to answer calls and record messages.

In this case, messages you expect to be recorded by the answering system will be recorded on the voicemail service. For more information, see "For landline voicemail service subscribers" (page 47).

- When using the base unit or handset to listen to messages, the noise reduction feature (page 19) is activated automatically in spite of the setting (NR is not displayed).

Using the base unit

When new messages have been recorded:

- [▶■] on the base unit flashes.
- 00 is displayed on the base unit with the total number of new messages.

Press [▶■].

- During playback, [▶■] on the base unit lights.
- If new messages have been recorded, the base unit plays back new messages.
- If there are no new messages, the base unit plays back all messages.

Operating the answering system during playback

Key	Operation
[▲] or [▼] OR [AMPLIFIED VOLUME]*1	Adjust the speaker volume
[◀◀]	Repeat message*2
[▶▶]	Skip message
[PAUSE]	Pause message To resume playback, press [▶■].
[▶■]	Stop playback
[ERASE]	Erase currently playing message

*1 Each press [AMPLIFIED VOLUME], speaker volume is increased by several levels.

*2 If pressed within the first 5 seconds of a message, the previous message is played.

Calling back (Caller ID subscribers only)

Lift the corded handset.

■ Editing the number before calling back

- 1 Press [EDIT] during playback.
- 2 Edit the number.
- 3 Lift the corded handset.

Rewinding the message

Press and hold [◀◀] until the unit plays the desired part of the message.

- During rewinding, the base unit makes a continuous beeping sound. Rewinding speed may vary depending on the recorded message.
- At the beginning of the message, the unit plays the message at normal speed.

Fast-forwarding the message

Press and hold [▶▶] until the unit plays the desired part of the message.

- During fast-forwarding, the base unit makes a continuous beeping sound. Fast-forwarding speed may vary depending on the recorded message.
- Even if you press and hold [▶▶] when the end of this message is played, the next message is played at normal speed.

Erasing all messages

Press [ERASE] 2 times while the unit is not in use.

Using the handset

When new messages have been recorded, **00** is displayed on the handset with the total number of new messages.

- 1 To listen to new messages:
[MENU]#323
To listen to all messages:
[MENU]#324
- 2 When finished, press [OFF].

Note:

- To switch to the receiver, press [↶].

Operating the answering system

[MENU] → **00** → [OK]

Key	Operation
[▲] or [▼]	Adjust the receiver or speaker volume (during playback)
1 or [◀]	Repeat message (during playback)*1
2 or [▶]	Skip message (during playback)
3	Enter the "Settings" menu
4	Play new messages
5	Play all messages
6	Play greeting message
7 6	Record greeting message
8	Turn answering system on
[MENU]	Pause message*2
9 or [STOP]	Stop recording Stop playback
0	Turn answering system off
* 4	Erase currently playing message
* 5	Erase all messages
* 6	Reset to a pre-recorded greeting message

- *1 If pressed within the first 5 seconds of a message, the previous message is played.
- *2 To resume playback:
[↕]: "Play" → [OK]
- *3 You can also erase as follows:
[MENU] → [↕]: "Erase" → [OK] → [↕]: "Yes" → [OK]

Calling back (Caller ID subscribers only)

- 1 Press [MENU] during playback.
- 2 [↕]: "Call Back" → [OK]

■ Editing the number before calling back

- 1 Press [MENU] during playback.
- 2 [↕]: "Edit & Call" → [OK]
- 3 Edit the number. → [↶]

Erasing all messages

- 1 [MENU]#325
- 2 [↕]: "Yes" → [OK] → [OFF]

Advanced new message alerting features

Audible message alert

This feature allows the base unit to beep to inform you of a new message arrival when new messages are recorded. The base unit beeps 2 times every minute until you listen to the messages, if the "Base Unit Beep" setting is turned on. The default setting is "off". You can configure this setting using either the base unit or one of the handsets.

Handset / Base Unit

- 1 [MENU]#339
- 2 [↕]: Select the desired setting. → [OK]
- 3 Proceed with the operation for your unit.
Handset: [OFF]
Base unit: [EXIT]

New message alert by a call

This feature allows you to receive a notification by phone when new messages are recorded. The base unit calls a phone number you specify. You can then operate the answering system remotely to listen to the new message. To use this feature, you must:

- store a phone number to which the unit makes the call to.
- turn on the new message alert setting.

After you answer the new message alert call, you can listen to messages from that call (page 45).

Answering System

You can configure this setting using either the base unit or one of the handsets.

Important:

- A new message alert is stopped 1 minute after the unit starts to call. The unit will not retry the call even if the call is not answered.

Storing a phone number to which the unit makes an alert call

Handset

■ From the phonebook:

- 1 [MENU]#338
- 2 [↕]: "Notification to" → [OK] → [ADD]
- 3 [↕]: "Phonebook" → [OK]
- 4 [↕]: Select the desired phonebook entry. → [OK] → [OFF]

■ By entering a phone number:

- 1 [MENU]#338
- 2 [↕]: "Notification to" → [OK] → [ADD]
- 3 [↕]: "Manual" → [OK]
- 4 Enter the desired name (16 characters max.). → [OK]
- 5 Enter the desired number (24 digits max.). → [OK] 2 times → [OFF]

Base unit

■ From the phonebook:

- 1 [MENU]#338
- 2 [↕]: "Notification to" → [OK] → [□□]
- 3 [↕]: Select the desired phonebook entry. → [OK] → [EXIT]

■ By entering a phone number:

- 1 [MENU]#338
- 2 [↕]: "Notification to" → [OK] → [EDIT]
- 3 Enter the desired name (16 characters max.). → [OK]
- 4 Enter the desired number (24 digits max.). → [OK] 2 times → [EXIT]

Turning on/off the new message alert setting

Handset / Base Unit

- 1 [MENU]#338
- 2 [↕]: "On/Off" → [OK]
- 3 [↕]: Select the desired setting. → [OK]
- 4 Proceed with the operation for your unit.
Handset: [OFF]
Base unit: [EXIT]

Editing the set phone number

Handset

- 1 [MENU]#338
- 2 [↕]: "Notification to" → [OK]
- 3 [MENU] → [↕]: "Edit" → [OK]
- 4 Edit the name if necessary (16 characters max.). → [OK]
- 5 Edit the phone number if necessary (24 digits max.). → [OK] 2 times → [OFF]

Base Unit

- 1 [MENU]#338
- 2 [↕]: "Notification to" → [OK] → [EDIT]
- 3 Edit the name if necessary (16 characters max.). → [OK]
- 4 Edit the phone number if necessary (24 digits max.). → [OK] 2 times → [EXIT]

Erasing the set phone number

Handset

- 1 [MENU]#338
- 2 [↕]: "Notification to" → [OK]
- 3 [MENU] → [↕]: "Erase" → [OK]
- 4 [↕]: "Yes" → [OK] → [OFF]
 - The new message alert setting is turned off.

Base Unit

- 1 [MENU]#338
- 2 [↕]: "Notification to" → [OK] → [ERASE]
- 3 [↕]: "Yes" → [OK] → [EXIT]
 - The new message alert setting is turned off.

Activating/inactivating the remote access code to play messages

If you activate this feature, you must enter the remote access code (page 45) to play the new message from the new message alert call. This is so that unauthorised parties cannot listen to your messages. The default setting is “Inactivate”.

- “Inactivate”: You can listen to the message by pressing **[4]** to play new messages (without entering the remote access code).
- “Activate”: You must enter your remote access code and then press **[4]** to play new message.

Handset / Base Unit

- 1 **[MENU]** **[#]** **[3]** **[3]** **[8]**
- 2 **[↕]**: “Remote Code” → **[OK]**
- 3 **[↕]**: Select the desired setting. → **[OK]**
- 4 Proceed with the operation for your unit.
Handset: **[OFF]**
Base unit: **[EXIT]**

Listening to messages

After you answer the new message alert, you can listen to the messages as follows.

■ When the remote access code is set to “Inactivate”:

Press **[4]** to play the new message during the announcement.

■ When the remote access code is set to “Activate”:

- 1 Enter the remote access code (page 45) during the announcement.
- 2 Press **[4]** to play the new message.

Note:

- Within 10 seconds after listening to new messages, you can press **[#]** **[9]** during the call to turn off the new message alert by a call feature.
- Even if the unit makes a new message alert call, the handset redial list does not show the record. However, on the base unit redial list it is shown as “Message Alert”.

Remote operation

Using a touch-tone phone, you can call your phone number from outside and access the unit to listen to messages or change answering system settings. The unit’s voice guidance prompts you to press certain dial keys to perform different operations.

Remote access code

A 3-digit remote access code must be entered when operating the answering system remotely. This code prevents unauthorised parties from listening to your messages remotely. You can configure this setting using either the base unit or one of the handsets.

Important:

- In order to operate the answering system remotely, you must first set a remote access code.

Handset / Base Unit

- 1 **[MENU]** **[#]** **[3]** **[0]** **[6]**
- 2 To turn on remote operation, enter the desired 3-digit remote access code.
- 3 **[OK]**
- 4 Proceed with the operation for your unit.
Handset: **[OFF]**
Base unit: **[EXIT]**

Deactivating remote operation

Press **[X]** in step 2 on “Remote access code”, page 45.

- The entered remote access code is deleted.

Using the answering system remotely

- 1 Dial your phone number from a touch-tone phone.
- 2 After the greeting message starts, enter your remote access code.
- 3 Follow the voice guidance prompts as necessary or control the unit using remote commands (page 46).
- 4 When finished, hang up.

Answering System

Voice guidance

During remote operation, the unit's voice guidance starts and prompts you to press **[1]** to perform a specific operation, or press **[2]** to listen to more available operations.

Note:

- If you do not press any dial keys within 10 seconds after a voice guidance prompt, the unit disconnects your call.

Remote commands

You can press dial keys to access certain answering system functions without waiting for the voice guidance to prompt you.

Key	Operation
[1]	Repeat message (during playback)*1
[2]	Skip message (during playback)
[4]	Play new messages
[5]	Play all messages
[6]	Play greeting message
[7]	Record greeting message
[9]	Stop recording Stop playback
[0]	Turn answering system off
[*] [4]	Erase currently playing message
[*] [5]	Erase all messages
[*] [6]	Reset to a pre-recorded greeting message (during greeting message playback)
[*] [#]	End remote operation (or hang up)

*1 If pressed within the first 5 seconds of a message, the previous message is played.

Turning on the answering system remotely

- 1 Dial your phone number from a touch-tone phone.
- 2 Let the phone ring 20 times.
 - A long beep is heard.

- 3 Enter your remote access code within 10 seconds after the long beep.
 - The greeting message is played back.
 - You can either hang up, or enter your remote access code again and begin remote operation (page 45).

Answering system settings

Call screening

Handset / Base Unit

While a caller is leaving a message, you can listen to the call through the unit's speaker.

To adjust the speaker volume,

- press **[▲]** or **[▼]** repeatedly.
- press **[AMPLIFIED VOLUME]** on the base unit repeatedly.
- Each press **[AMPLIFIED VOLUME]**, speaker volume is increased by several levels.

You can answer the call by:

- lifting the corded handset from the base unit, or
- pressing **[hook]** on the handset.

Call screening can be set for each unit. The default setting is "On".

- 1 **[MENU]#[3][1][0]**
- 2 **[↕]**: Select the desired setting. → **[OK]**
- 3 Proceed with the operation for your unit.
Handset: [OFF]
Base unit: [EXIT]

Number of rings before the unit answers a call

You can change the number of times the phone rings "Number of Rings" before the unit answers a call. You can select 2 to 9 rings, or "Auto".

The default setting is "8 Rings".

"Auto": The unit's answering system answers at the end of the 5th ring when new messages have been recorded, or at the end of the 8th ring when there are no new messages. If you call your phone from outside to listen to new messages (page 45), you know that there are no new messages when the phone rings for the 6th time. You can then hang up without being charged for the call. You can configure this setting using either the base unit or one of the handsets.

Handset / Base Unit

- 1 **[MENU]** **#** **2** **1** **1**
- 2 **[↕]**: Select the desired setting. → **[OK]**
- 3 Proceed with the operation for your unit.
Handset: [OFF]
Base unit: [EXIT]

For landline voicemail service subscribers

To receive voicemail and use answering system properly, please note the following:

- To use the voicemail service (page 48) provided by your phone service provider rather than the unit's answering system, turn off the answering system (page 41).
- To use this unit's answering system rather than the voicemail service provided by your phone service provider, please contact your phone service provider to deactivate your voicemail service.

If your phone service provider cannot do this:

- Set this unit's "**Number of Rings**" setting so that this unit's answering system answers calls before the voicemail service of your phone service provider does. It is necessary to check the number of rings required to activate the voicemail service provided by your phone service provider before changing this setting.
- Change the number of rings of the voicemail service so that the answering system can answer the call first. To do so, contact your phone service provider.

Caller's recording time

You can change the maximum message recording time allowed for each caller. The default setting is "**3 Minutes**".

You can configure this setting using either the base unit or one of the handsets.

Handset / Base Unit

- 1 **[MENU]** **#** **3** **0** **5**
- 2 **[↕]**: Select the desired setting. → **[OK]**
- 3 Proceed with the operation for your unit.
Handset: [OFF]
Base unit: [EXIT]

Selecting "Greeting Only"

You can select "**Greeting Only**" which sets the unit to announce a greeting message to callers but not record messages.

Select "**Greeting Only**" in step 2 on "Caller's recording time", page 47.

Note:

- When you select "**Greeting Only**":
 - If you do not record your own message, the unit will play the pre-recorded greeting-only message asking callers to call again later.
 - If you use your own message, record the greeting-only message asking callers to call again later (page 41).

Useful Information

Voicemail service

Voicemail is an automatic answering service offered by your phone service provider. After you subscribe to this service, your service provider/ telephone company's voicemail system answers calls for you when you are unavailable to answer the phone or when your line is busy. Messages are recorded by your phone service provider, not your telephone.

When you have new messages,  is displayed on the handset if message indication service is available. Please contact your phone service provider for details of this service.

Important:

- If  still remains on the display even after you have listened to new messages, turn it off by pressing and holding **#** for 2 seconds.
- To use the voicemail service provided by your phone service provider rather than the unit's answering system, turn off the answering system (page 41). For details, see page 47.

Wall mounting

The base unit can be mounted on a wall by changing the wall mounting adaptor's position.

Note:

- Make sure that the wall and the fixing method are strong enough to support the weight of the unit.
- Drive the screws (not supplied) into the wall.

Base unit

- 1 To remove the wall mounting adaptor, push down the release levers **(1)**. Remove the adaptor **(2)**.

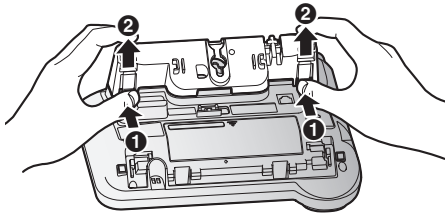

- 2
 - ① Turn the adaptor so that the words "UP WALL" are facing up.
 - ② Tuck the telephone line cord inside the wall mounting adaptor.
 - ③ Connect the AC adaptor cord and telephone line cord.

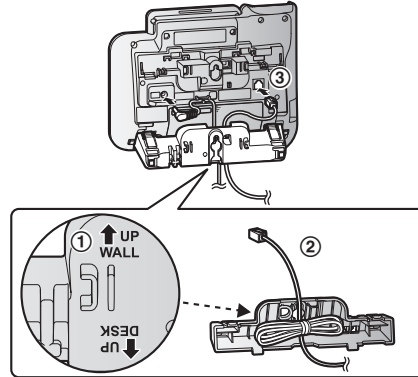

- 3 Insert the lower tabs of the adaptor into the unit's bottom slots **(1)**, then insert by pushing down the levers of the adaptor into the upper slots **(2)**.

- The words "UP WALL" should be facing up.

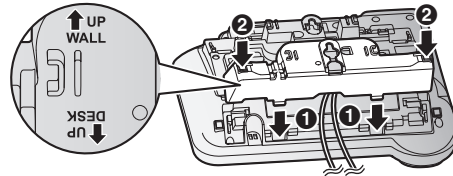

- 4 Mount the unit on a wall then slide down to secure in place.

- A** Screws
- B** 83 mm

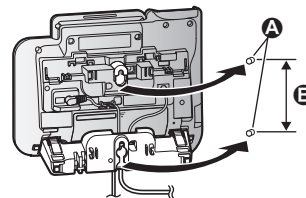

Character entry

The dial keys are used to enter characters and numbers. Each dial key has multiple characters assigned to it. The characters that can be entered depend on the character entry mode (page 49).

- **Handset:** Press [◀] or [▶] to move the cursor left or right.
- **Base unit:** Press [◀◀] or [▶▶] to move the cursor left or right.
- Press dial keys to enter characters and numbers.
- Press [CLEAR] to erase the character or number highlighted by the cursor. Press and hold [CLEAR] to erase all characters or numbers.
- Press [A→a] to switch between uppercase and lowercase.
- To enter another character located on the same dial key, press [▶] on the handset or [▶▶] on the base unit to move the cursor to the next space, then press the appropriate dial key.
- If you do not press any dial key within 2 seconds after entering a character, the character is fixed and the cursor moves to the next space.

Character entry modes

The available character entry modes are Alphabet (ABC), Numeric (0-9), Greek (ΑΒΓ), Extended 1 (ΑĂĂ), Extended 2 (ŜŜŜ), and Cyrillic (АБВ). When in these entry modes except Numeric, you can select which character is entered by pressing a dial key repeatedly.

When the unit displays the character entry screen:

Handset: [ECO] → [↕]: Select a character entry mode. → [OK]

Base unit: [1/A/Ā] → [↕]: Select a character entry mode. → [OK]

Note:

- _ in the following tables represents a single space.

Alphabet character table (ABC)

0	1	2	3	4	5	6	7	8	9	#
_ 0	& ' () * , - . / 1	A B C 2 a b c 2	D E F 3 d e f 3	G H I 4 g h i 4	J K L 5 j k l 5	M N O 6 m n o 6	P Q R S 7 p q r s 7	T U V 8 t u v 8	W X Y Z 9 w x y z 9	#

Numeric entry table (0-9)

0	1	2	3	4	5	6	7	8	9	#
0	1	2	3	4	5	6	7	8	9	#

Greek character table (ΑΒΓ)

0	1	2	3	4	5	6	7	8	9	#
_ 0	& ' () * , - . / 1	A B Γ 2	Δ E Z 3	H Θ I 4	K Λ M 5	N Ξ O 6	Π Ρ Σ 7	T Υ Φ 8	X Ψ Ω 9	#

Useful Information

Extended 1 character table (AÄÅ)

0	1	2	3	4	5	6	7	8	9	#
_ 0 & ' () * , - . / 1	A À Á Â Ã Ä Å Æ B C Ç 2	D E È É Ê Ë Ë F 3	G Ğ H I Ì Í Ï Î Ï 4	J K L 5	M N Ñ O Ò Ó Ô Õ Ö ø 6	P Q R S Ş ß 7	T U Û Ú Ü Ü Û V 8	W Ŵ X Y Ŷ Z 9	#	
										a à á â ã ä å æ b c ç 2

- The following are used for both uppercase and lowercase: ø Ŵ Ŷ

Extended 2 character table (ŠŠš)

0	1	2	3	4	5	6	7	8	9	#
_ 0 & ' () * , - . / 1	A Á Ā Ā B C Ć Č 2	D Ď E É Ě Ě F 3	G H I Í 4	J K L Ł Ł Ł 5	M N Ń Ń O Ó Ö Ö 6	P Q R Ŕ Ŗ Š Š Š 7	T Ť U Ú Ů Ů ú v 8	W X Y Ÿ Ź Ž 9	#	
										a á ā Ā b c Ć č 2

- The following are used for both uppercase and lowercase:

Ą Ć Ć Ę Ł Ł Ł Ń Ń Š Š Ÿ Ź Ž Ž

Cyrillic character table (АБВ)

0	1	2	3	4	5	6	7	8	9	#
_ 0 Є І І Ÿ	& ' () * , - . / 1	А Б В Г 2	Д Е Ж З 3	И Й К Л 4	М Н О П 5	Р С Т У 6	Ф Х Ц Ч 7	Ш Щ Ъ Ы 8	Ь Э Ю Я 9	#

Error messages

Display message	Cause/solution
Base no power or No link. Reconnect AC adaptor.	<ul style="list-style-type: none"> Confirm the base unit's AC adaptor is connected to the unit and the power outlet correctly. The handset has lost communication with the base unit. Move closer to the base unit and try again. Unplug the base unit's AC adaptor to reset the unit. Reconnect the adaptor and try again. The handset's registration may have been cancelled. Re-register the handset (page 37).
Check Phone Line	<ul style="list-style-type: none"> The supplied telephone line cord has not been connected yet or not connected properly. Check the connections (page 10).
Error	<ul style="list-style-type: none"> Recording was too short. Try again.
Memory Full	<ul style="list-style-type: none"> The phonebook memory is full. Erase unwanted entries (page 25). The call block list memory is full. Erase unwanted entries (page 23).
Use rechargeable battery.	<ul style="list-style-type: none"> A wrong type of battery such as alkaline or manganese was inserted. Use only the rechargeable Ni-MH batteries noted on page 3, 7.
You must first subscribe to Caller ID.	<ul style="list-style-type: none"> You must subscribe to a Caller ID service. Once you receive caller information after subscribing to a Caller ID service, this message will not be displayed.

Troubleshooting

If you still have difficulties after following the instructions in this section, disconnect the base unit's AC adaptor, then reconnect the base unit's AC adaptor. Remove the batteries from the handset, and then insert them into the handset again.

If the base unit batteries for power backup are installed, remove the batteries from the base unit, and then insert them into the base unit again.

General use

Problem	Cause/solution
The handset does not turn on even after installing charged batteries.	<ul style="list-style-type: none"> Place the handset on the charger to turn on the handset.
The unit does not work.	<ul style="list-style-type: none"> Make sure the batteries are installed correctly (page 10). Fully charge the batteries (page 11). Check the connections (page 10). Unplug the base unit's AC adaptor and remove the batteries from the handset to reset the unit. Reconnect the adaptor, insert the batteries into the handset and try again. The handset has not been registered to the base unit. Register the handset (page 37).
The handset display is blank.	<ul style="list-style-type: none"> The handset is not turned on. Turn the power on (page 15).



Useful Information

Problem	Cause/solution
I cannot hear a dial tone.	<ul style="list-style-type: none"> • Make sure that you are using the supplied telephone line cord. Your old telephone line cord may have a different wiring configuration. • The base unit's AC adaptor or telephone line cord is not connected. Check the connections. • Disconnect the base unit from the telephone line and connect the line to a known working telephone. If the working telephone operates properly, contact our service personnel to have the unit repaired. If the working telephone does not operate properly, contact your phone service provider.
The base unit beeps.	<ul style="list-style-type: none"> • New messages have been recorded. Listen to the new messages (page 42).
The unit does not work during a power failure.	<ul style="list-style-type: none"> • You can insert 2 AAA (R03) batteries (not supplied) into the base unit that will power the unit temporarily in the event of a power failure (page 11). • The base unit display is blank if the saving mode is "On" (page 12).

Menu list

Problem	Cause/solution
The display is in a language I cannot read.	<ul style="list-style-type: none"> • Change the display language (page 15).
I cannot activate the eco mode.	<ul style="list-style-type: none"> • You cannot set eco mode when you set the repeater mode "On". If required, set the repeater mode to "Off" (page 38).
I cannot register a handset to a base unit.	<ul style="list-style-type: none"> • The maximum number of handsets (6) is already registered to the base unit. Cancel unused handset registrations from the base unit (page 38). • You entered the wrong PIN. If you forget your PIN, see "I cannot remember the PIN." (page 52).
I cannot remember the PIN.	<ul style="list-style-type: none"> • Change the PIN using the following method. Handset/Base unit: <ol style="list-style-type: none"> 1 [MENU]#132 2 *7000 3 Enter the new 4-digit base unit PIN. → [OK] 4 [↕]: "Yes" → [OK] → [OFF]/[EXIT]

Battery recharge

Problem	Cause/solution
The handset beeps and/or  flashes.	<ul style="list-style-type: none"> • Battery charge is low. Fully charge the batteries (page 11).
I fully charged the batteries, but <ul style="list-style-type: none"> –  still flashes or – the operating time seems to be shorter. 	<ul style="list-style-type: none"> • Clean the battery ends (+, -) and the charge contacts with a dry cloth and charge again. • It is time to replace the batteries (page 10).

Making/answering calls, intercom

Problem	Cause/solution
📵 is displayed.	<ul style="list-style-type: none"> • The handset is too far from the base unit. Move closer. • The base unit's AC adaptor is not properly connected. Reconnect AC adaptor to the base unit. • The handset is not registered to the base unit. Register it (page 37). • Activating eco mode reduces the range of the base unit in standby mode. If required, turn eco mode off (page 16).
Noise is heard, sound cuts in and out.	<ul style="list-style-type: none"> • You are using the handset or base unit in an area with high electrical interference. Re-position the base unit and use the handset away from sources of interference. • Move closer to the base unit. • If you use a DSL/ADSL service, we recommend connecting a DSL/ADSL filter between the base unit and the telephone line jack. Contact your DSL/ADSL provider for details.
Sound quality seems to be getting worse.	<ul style="list-style-type: none"> • You have registered a handset that is not recommended (page 4). The clearest sound quality is only possible by registering the recommended handset.
The unit does not ring.	<ul style="list-style-type: none"> • The ringer volume is turned off. Adjust ringer volume (page 18, 30). • Do not disturb mode is turned on. Turn it off (page 34).
I cannot make a call.	<ul style="list-style-type: none"> • You dialled a call restricted number (page 36). • The key lock feature is turned on. Turn it off (page 21).

Caller ID/Talking Caller ID

Problem	Cause/solution
Caller information is not displayed.	<ul style="list-style-type: none"> • You must subscribe to a Caller ID service. Contact your phone service provider for details. • If your unit is connected to any additional telephone equipment, remove and plug the unit directly into the wall jack. • If you use a DSL/ADSL service, we recommend connecting a DSL/ADSL filter between the base unit and the telephone line jack. Contact your DSL/ADSL provider for details. • Other telephone equipment may be interfering with this unit. Disconnect the other equipment and try again.
Caller information is displayed or announced late.	<ul style="list-style-type: none"> • Depending on your phone service provider, the unit may display or announce the caller's information at the 2nd ring or later. Set the first ring to "OFF" (page 30). • Move closer to the base unit.
Caller information is not announced.	<ul style="list-style-type: none"> • To use the Talking Caller ID feature, store the name and phone number in the phonebook (page 24). • The handset or base unit's ringer volume is turned off. Adjust it (page 18, 30). • The Talking Caller ID feature is turned off. Turn it on (page 30). • Depending on the number of rings setting, the answering system may answer calls before announcing the caller information. Select a different setting (page 46).

Useful Information

Problem	Cause/solution
Time on the unit has shifted.	<ul style="list-style-type: none">● Incorrect time information from incoming Caller ID changes the time. Set the time adjustment to “Manual” (off) (page 30).
The name stored in the phonebook is not fully displayed while an outside call is being received.	<ul style="list-style-type: none">● Edit the phonebook entry name to fit in 1 line of text (page 25).

Answering system

Problem	Cause/solution
The unit does not record new messages.	<ul style="list-style-type: none">● The answering system is turned off. Turn it on (page 41).● The message memory is full. Erase unwanted messages (page 42).● The recording time is set to “Greeting Only”. Change the setting (page 47).● Your phone service provider’s voicemail service may be answering your calls before the unit’s answering system can answer your calls. Change the unit’s number of rings setting (page 46) to a lower value, or contact your phone service provider.● The answering system will not answer incoming calls while the other devices such as handsets are engaged in a call.
I cannot operate the answering system remotely.	<ul style="list-style-type: none">● The remote access code is not set. Set the remote access code (page 45).● You are entering the wrong remote access code. If you have forgotten your remote access code, enter the remote access code setting to check your current code (page 45).● The answering system is turned off. Turn it on (page 46).
The unit does not emit the specified number of rings.	<ul style="list-style-type: none">● If the first ring is turned off (page 30), the number of rings decreases by 1 from the specified number of rings.

Liquid damage

Problem	Cause/solution
Liquid or other form of moisture has entered the handset/base unit.	<ul style="list-style-type: none">● Disconnect the AC adaptor and telephone line cord from the base unit. Remove the batteries from the handset and leave to dry for at least 3 days. After the handset/base unit are completely dry, reconnect the AC adaptor and telephone line cord. Insert the batteries and charge fully before use. If the unit does not work properly, contact an authorised service centre.

Caution:

- To avoid permanent damage, do not use a microwave oven to speed up the drying process.

Conditions of guarantee

This guarantee is in addition to and does not in any way affect any statutory or other rights of consumer purchasers. If within the applicable guarantee period, the product proves to be defective by reason of faulty design, workmanship or materials, we undertake subject to the following conditions to have the defective product (or any part or parts there of) repaired or replaced free of charge.

1. The product shall have been purchased and used solely within either the U.K. or Ireland and in accordance with standard operating instructions and the technical and/or Safety Standards required in the U.K.
2. On being found defective, please consult with the retailer from where it was purchased for assistance.
3. This guarantee shall not apply to damage caused through fire, accident, lightning, misuse, wear and tear, neglect, incorrect adjustment or repair, to damage caused through installation, adaption, modification or use in an improper manner or inconsistent with the technical and/or safety standards required in the country where this product is used, or to damage occurred during transit to or from the purchaser.
4. If at any time during the guarantee period any part or parts of the product are replaced with a part or parts not supplied or approved by us or of an objective quality safe and suitable for the product, or the product has been dismantled or repaired by any person not authorised by us, we shall have the right to terminate this guarantee in whole or in part immediately without further notice.
5. The purchaser's sole and exclusive remedy under this guarantee against us is for the repair or replacement of the product or any defective part or parts and no other remedy, including, but not limited to, incidental or consequential damage or loss of whatsoever nature shall be available to the purchaser.
6. This guarantee shall not apply to batteries and any other items of limited natural life.
7. Our decision on all matters relating to complaints shall be final. Any product or defective part which has been replaced shall become our property.
8. The guarantee period applicable to this product shall be 12 months.

Please keep these operating instructions with your receipt.

Panasonic U.K. a branch of Panasonic Marketing Europe GmbH

Receipt No.	Date of purchase
Model No.	Serial No.

Index

Index

- A** Additional handsets: 37
 - Alarm: 33
 - Answering calls: 18
 - Answering system: 41
 - Call screening: 46
 - Erasing messages: 42, 43, 46
 - Greeting message: 41
 - Greeting only: 47
 - Listening to messages: 42, 43, 45
 - New message alerting: 43
 - Number of rings: 46
 - Recording time: 47
 - Remote access code: 45
 - Remote operation: 45
 - Turning on/off: 41
 - Auto intercom: 20
 - Auto talk: 18, 31
- B** Baby monitor: 34
 - Battery: 10, 12
 - Battery saving mode: 12
- C** Call restriction: 36
 - Call share: 19
 - Call waiting: 19
 - Call Waiting Caller ID: 19
 - Caller ID service: 39
 - Caller list: 39
 - Caller list edit: 40
 - Category: 24
 - Chain dial: 25
 - Character entry: 49
 - CID (Caller ID): 39
 - Conference calls: 19
 - Control type: 13, 14
- D** Date and time: 15
 - Direct command code: 28
 - Display
 - Contrast: 31
 - Language: 15
 - Do not disturb mode: 34
- E** Eco mode: 16
 - Equalizer: 19
 - Error messages: 51
- F** First ring: 30
- H** Handset
 - Deregistration: 38
 - Locator: 13
 - Name: 36
 - Registration: 37
 - Hold: 18
- I** Intercom: 20
- K** Key finder: 30, 32
 - Key lock: 21
 - Keytones: 31
- M** Making calls: 17
 - Missed calls: 39
 - Mute: 18
- N** Noise reduction: 19
 - Nuisance call block: 22
- O** OK Key: 13, 14
 - One-touch dial buttons: 27
- P** Pause: 17
 - Phonebook: 24
 - PIN: 37
 - Power failure (power backup operation): 11
 - Power on/off: 15
 - Privacy mode: 31
- R** Recall/flash: 19
 - Redialling: 17
 - Repeater: 38
 - Ringer tone: 30
- S** Security for phone calls: 37
 - Speakerphone: 17
 - Speed dial: 25
- T** Talking Caller ID: 39
 - Time adjustment: 30
 - Transferring calls: 19
 - Troubleshooting: 51
- V** Voicemail: 48
 - Volume
 - Receiver: 17
 - Ringer (Base unit): 18, 30
 - Ringer (Handset): 18, 30
 - Speaker: 17
- W** Wall mounting: 48

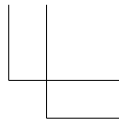
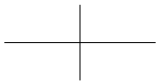
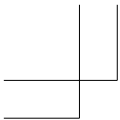

Notes

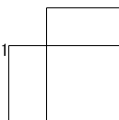
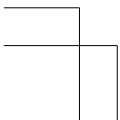
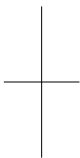

Notes

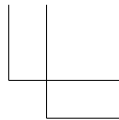
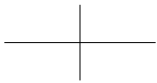
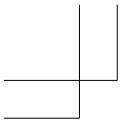

Notes

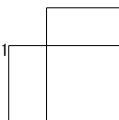
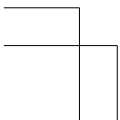
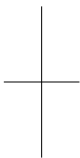

IMPORTANT!

If your product is not working properly. . .

- ① **Reconnect AC adaptor to the base unit.**
- ② **Check if telephone line cord is connected.**
- ③ **Use rechargeable Ni-MH batteries.**
(Alkaline/Manganese/Ni-Cd batteries CANNOT be used.)
- ④ **Read troubleshooting page in the Operating Instructions.**



If you still have any problems, please call the **Panasonic DECT Helpline**

0844 844 3899 (U.K.)

01289 8333 (Ireland)

or contact us through our website:

www.panasonic.co.uk

Buy online via our eShop: www.shop.panasonic.eu

Sales Department:

Panasonic U.K. a branch of
Panasonic Marketing Europe GmbH

Panasonic House, Willoughby Road, Bracknell, Berkshire, RG12 8FP

Panasonic Corporation

1006, Oaza Kadoma, Kadoma-shi, Osaka 571-8501, Japan
<http://www.panasonic.com>

© Panasonic Corporation 2015



PNQX6781XA

PNQX6781XA PT0115MU2027 (E)