

RB551V-30-HF

$I_o = 500 \text{ mA}$
 $V_R = 20 \text{ Volts}$
RoHS Device
Halogen Free

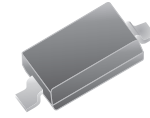

Features

- Low reverse current.
- Designed for mounting on small surface.
- Extremely thin / leadless package.
- Majority carrier conduction.

Mechanical data

- Case: SOD-323 Standard package, molded plastic.
- Terminals: Gold plated, solderable per MIL-STD-750D, method 2026.
- Mounting position: Any.

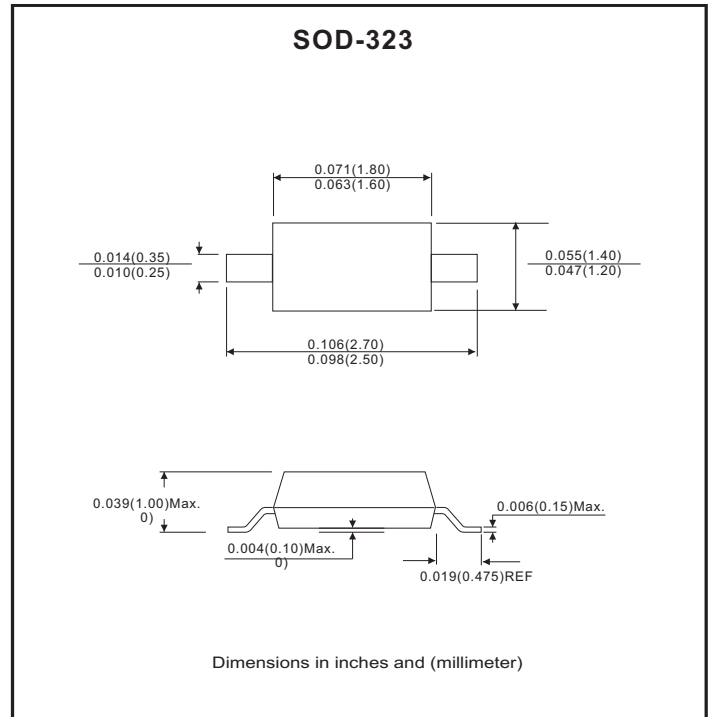

Maximum Ratings (at $T_A=25^\circ\text{C}$ unless otherwise noted)

Parameter	Conditions	Symbol	Min	Typ	Max	Unit
Repetitive peak reverse voltage		V_{RM}			30	V
Reverse voltage		V_R			20	V
Average forward current		I_o			500	mA
Forward current, surge peak	8.3ms single half sine-wave superimposed on rate load (JEDEC method)	I_{FSM}			2	A
Storage temperature		T_{STG}	-40		+125	$^\circ\text{C}$
Junction temperature		T_j			+125	$^\circ\text{C}$

Electrical Characteristics (at $T_A=25^\circ\text{C}$ unless otherwise noted)

Parameter	Conditions	Symbol	Min	Typ	Max	Unit
Forward voltage	$I_F = 100 \text{ mA}$ $I_F = 500 \text{ mA}$	V_F			0.36 0.47	V
Reverse current	$V_R = 20 \text{ V}$	I_R			100	μA

RATING AND CHARACTERISTIC CURVES (RB551V-30-HF)

Fig.1 - Forward Characteristics

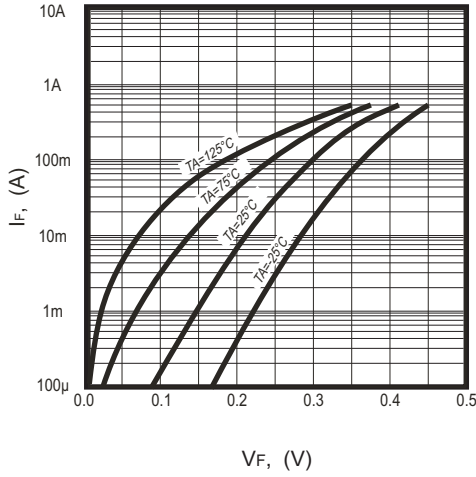

Fig.2 - Reverse characteristics

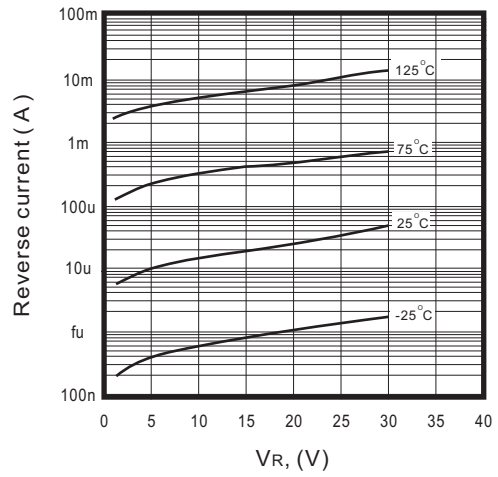

Fig.3 - Capacitance between terminals characteristics

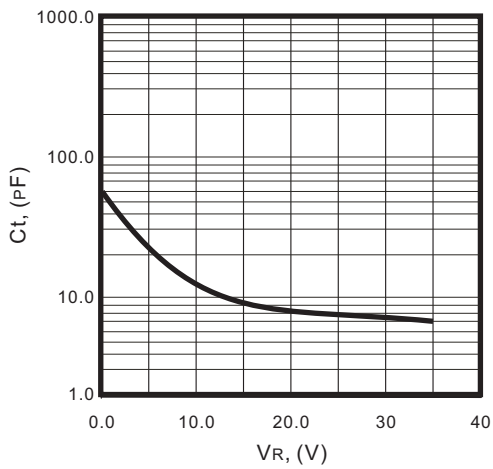
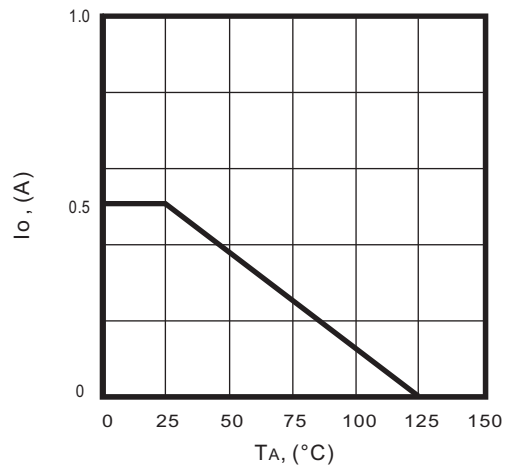
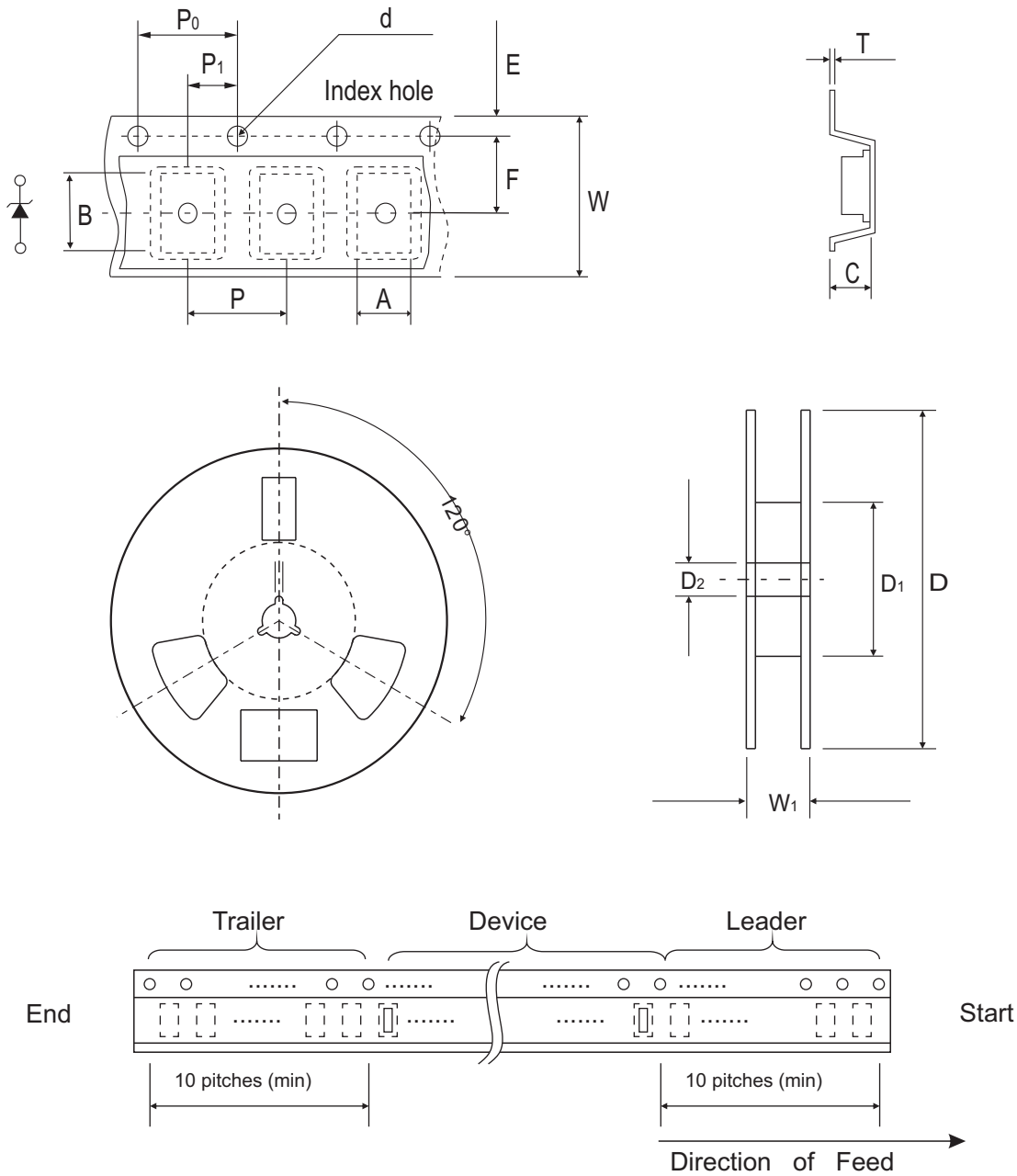

Fig.4 - Derating curve



Reel Taping Specification



SOD-323	SYMBOL	A	B	C	d	D	D1	D2
	(mm)	1.46 ± 0.10	2.90 ± 0.10	1.25 ± 0.10	1.50 ± 0.10	178 ± 1.00	54.40 ± 0.40	13.00 ± 0.20
	(inch)	0.057 ± 0.004	0.114 ± 0.004	0.049 ± 0.004	0.059 ± 0.004	7.008 ± 0.039	2.142 ± 0.016	0.512 ± 0.008

SOD-323	SYMBOL	E	F	P	P0	P1	W	W1
	(mm)	1.75 ± 0.10	3.50 ± 0.05	4.00 ± 0.10	4.00 ± 0.10	2.00 ± 0.10	8.00 + 0.30 / - 0.10	9.50 ± 1.00
	(inch)	0.069 ± 0.004	0.138 ± 0.002	0.158 ± 0.004	0.158 ± 0.004	0.079 ± 0.004	0.315 + 0.012 / - 0.004	0.374 ± 0.039

Marking Code

Part Number	Marking Code
RB551V-30-HF	. D



Suggested PAD Layout

SIZE	SOD-323	
	(mm)	(inch)
A	2.33	0.092
B	0.70	0.028
C	0.70	0.028
D	3.03	0.119
E	1.63	0.064

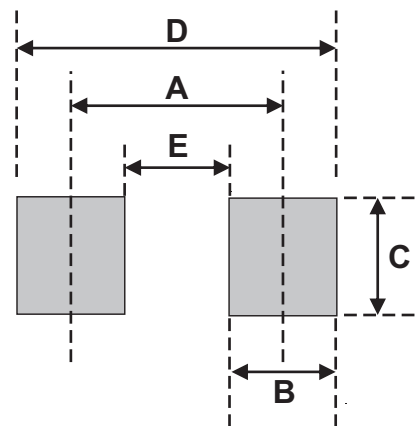

Notes:

GENERAL TOLERANCE $\pm 0.05\text{mm}$ ($\pm 0.002\text{inch}$)

Standard Packaging

Case Type	Qty per Reel	Reel Size
	(Pcs)	(inch)
SOD-323	3000	7

Mouser Electronics

Authorized Distributor

Click to View Pricing, Inventory, Delivery & Lifecycle Information:

[Comchip Technology:](#)

[RB551V-30-HF](#)