



# Film Capacitors

## EMI Suppression Capacitors (MKP)

**Series/Type:** B32021 ... B32026

**Date:** June 2020

© TDK Electronics AG 2020. Reproduction, publication and dissemination of this publication, enclosures hereto and the information contained therein without TDK Electronics' prior express consent is prohibited.

### Typical applications

- Y2 class for interference suppression
- "Line to ground" applications.

### Climatic

- Max. operating temperature: 110 °C
- Climatic category (IEC 60068-1:2013): 40/110/56

### Construction

- Dielectric: polypropylene (MKP)
- Plastic case (UL 94 V-0)
- Epoxy resin sealing (UL 94 V-0)

### Features

- Very small dimensions
- Good self-healing properties
- High voltage capability
- RoHS-compatible
- Halogen-free capacitors available on request

### Terminals

- Parallel wire leads, lead-free tinned
- Special lead lengths available on request

### Marking

Manufacturer's logo, lot number, date code, rated capacitance (coded), capacitance tolerance (code letter), rated AC voltage (IEC), series number, sub-class (Y2), dielectric code (MKP), climatic category, passive flammability category, approvals.

### Delivery mode

Bulk (untaped)

Taped (Ammo pack or reel)

For taping details, refer to chapter "Taping and packing"

### Dimensional drawing



Dimensions in mm

| Lead spacing<br>$e \pm 0.4$ | Lead diameter<br>$d_1 \pm 0.05$ | Type              |
|-----------------------------|---------------------------------|-------------------|
| 10                          | 0.6                             | B32021            |
| 15 ... 27.5                 | 0.8                             | B32022 ... B32024 |
| 37.5                        | 1.0                             | B32026            |

B32021 ... B32026

Y2 / 300 V AC

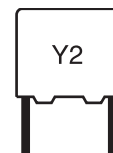

**Marking example (position of marks may vary):**

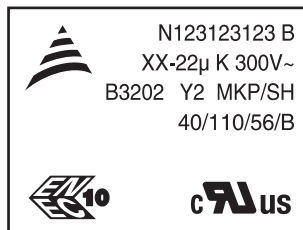

KMK1547-B

**Approvals**

| Approval marks | Standards   | Certificate                       |
|----------------|---|-----------------------------------|
|                | EN 60384-14:2014/A1:2016<br>IEC 60384-14:2013/AMD1:2016 | 40018909                          |
|                | UL 1414:2000<br>UL 1283:2005                            | E97863 / E157153                  |
|                | CSA C22.2 No.1:2004<br>CSA C22.2 No.8:2013              | E97863 / E157153 (approved by UL) |
|                | UL 60384-14:2014<br>CSA E60384-14:2013                  | E97863 (approved by UL)           |

|        |  |
|--------|--|
| Notes: | Effective January 2014, only for EMI supression capacitors:  |
|        | <ul style="list-style-type: none"> <li>– UL 60384-14:2014 certification replaces both UL 1414:2000 and UL 1283:2005 standards.</li> <li>– CSA C22.2 No.1.2004 and CSA C22.2 No.8:2013 are replaced by CSA E60384-14:2013.</li> <li>– References like 1414, 1283 are removed from the capacitor marking.</li> </ul> |
|        | Capacitors under UL 1414:2000, UL 1283:2005 produced during or before 2013, are accepted under UL scope.   |
|        | Capacitors under CSA C22.2 No.1:2004 / CSA C22.2 No.8:2013 produced during or before 2013, are accepted under cUL scope.   |

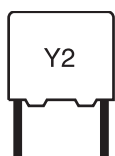

B32021 ... B32026

Y2 / 300 V AC

### Overview of available types

| Lead spacing     | 10 mm  | 15 mm  | 22.5 mm | 27.5 mm | 37.5 mm |
|------------------|--------|--------|---------|---------|---------|
| Type             | B32021 | B32022 | B32023  | B32024  | B32026  |
| $C_R$ ( $\mu$ F) |        |        |         |         |         |
| 0.0010           |        |        |         |         |         |
| 0.0015           |        |        |         |         |         |
| 0.0022           |        |        |         |         |         |
| 0.0033           |        |        |         |         |         |
| 0.0047           |        |        |         |         |         |
| 0.0056           |        |        |         |         |         |
| 0.0068           |        |        |         |         |         |
| 0.0082           |        |        |         |         |         |
| 0.010            |        |        |         |         |         |
| 0.015            |        |        |         |         |         |
| 0.022            |        |        |         |         |         |
| 0.033            |        |        |         |         |         |
| 0.047            |        |        |         |         |         |
| 0.056            |        |        |         |         |         |
| 0.068            |        |        |         |         |         |
| 0.082            |        |        |         |         |         |
| 0.10             |        |        |         |         |         |
| 0.15             |        |        |         |         |         |
| 0.22             |        |        |         |         |         |
| 0.33             |        |        |         |         |         |
| 0.39             |        |        |         |         |         |
| 0.47             |        |        |         |         |         |
| 0.56             |        |        |         |         |         |
| 0.68             |        |        |         |         |         |
| 0.82             |        |        |         |         |         |
| 1.0              |        |        |         |         |         |



### Ordering codes and packing units

| Lead spacing<br>mm | C <sub>R</sub><br>μF | Max. dimensions<br>w × h × l<br>mm | Ordering code<br>(composition see<br>below) | Ammo<br>pack<br>pcs./MOQ | Reel<br>pcs./MOQ | Untaped<br>pcs./MOQ |
|--------------------|----------------------|------------------------------------|---|--------------------------|------------------|---------------------|
| 10                 | 0.0010               | 4.0 × 9.0 × 13.0                   | B32021A3102+***                             | 4000                     | 6800             | 4000                |
|                    | 0.0015               | 4.0 × 9.0 × 13.0                   | B32021A3152+***                             | 4000                     | 6800             | 4000                |
|                    | 0.0022               | 4.0 × 9.0 × 13.0                   | B32021A3222+***                             | 4000                     | 6800             | 4000                |
|                    | 0.0033               | 4.0 × 9.0 × 13.0                   | B32021A3332+***                             | 4000                     | 6800             | 4000                |
|                    | 0.0047               | 5.0 × 11.0 × 13.0                  | B32021A3472+***                             | 3320                     | 5200             | 4000                |
|                    | 0.0056               | 5.0 × 11.0 × 13.0                  | B32021A3562+***                             | 3320                     | 5200             | 4000                |
|                    | 0.0068               | 5.0 × 11.0 × 13.0                  | B32021A3682+***                             | 3320                     | 5200             | 4000                |
|                    | 0.0082               | 6.0 × 12.0 × 13.0                  | B32021A3822+***                             | 2720                     | 4400             | 4000                |
|                    | 0.010                | 6.0 × 12.0 × 13.0                  | B32021A3103M***                             | 2720                     | 4400             | 4000                |
| 15                 | 0.010                | 5.0 × 10.5 × 18.0                  | B32022A3103+***                             | 4680                     | 5200             | 4000                |
|                    | 0.015                | 6.0 × 11.0 × 18.0                  | B32022A3153+***                             | 3840                     | 4400             | 4000                |
|                    | 0.022                | 6.0 × 12.0 × 18.0                  | B32022A3223M***                             | 3840                     | 4400             | 4000                |
|                    | 0.022                | 7.0 × 12.5 × 18.0                  | B32022B3223+***                             | 3320                     | 3600             | 4000                |
|                    | 0.033                | 8.0 × 14.0 × 18.0                  | B32022A3333+***                             | 2920                     | 3000             | 2000                |
|                    | 0.047                | 8.5 × 14.5 × 18.0                  | B32022A3473M***                             | 2720                     | 2800             | 2000                |
|                    | 0.047                | 9.0 × 17.5 × 18.0                  | B32022B3473+***                             | 2560                     | 2800             | 2000                |
|                    | 0.056                | 9.0 × 17.5 × 18.0                  | B32022A3563+***                             | 2560                     | 2800             | 2000                |
|                    | 0.068                | 9.0 × 17.5 × 18.0                  | B32022A3683M***                             | 2560                     | 2800             | 2000                |
|                    | 0.082                | 11.0 × 18.5 × 18.0                 | B32022A3823M***                             | —                        | 2200             | 1200                |

MOQ = Minimum Order Quantity, consisting of 4 packing units.

Further intermediate capacitance values on request.

#### Composition of ordering code

+ = Capacitance tolerance code:

M = ±20%

K = ±10%

\*\*\* = Packaging code:

289 = Straight terminals, Ammo pack

189 = Straight terminals, Reel

003 = Straight terminals, untaped  
(lead length 3.2 ±0.3 mm)

000 = Straight terminals, untaped  
(lead length 6 – 1 mm)



B32021 ... B32026

Y2 / 300 V AC

### Ordering codes and packing units

| Lead spacing<br>mm | C <sub>R</sub><br>μF | Max. dimensions<br>w × h × l<br>mm | Ordering code<br>(composition see<br>below) | Ammo<br>pack<br>pcs./MOQ | Reel<br>pcs./MOQ | Untaped<br>pcs./MOQ |
|--------------------|----------------------|------------------------------------|---|--------------------------|------------------|---------------------|
| 22.5               | 0.047                | 6.0 × 15.0 × 26.5                  | B32023A3473+***                             | 2720                     | 2800             | 2880                |
|                    | 0.056                | 6.0 × 15.0 × 26.5                  | B32023A3563M***                             | 2720                     | 2800             | 2880                |
|                    | 0.068                | 7.0 × 16.0 × 26.5                  | B32023A3683+***                             | 2320                     | 2400             | 2520                |
|                    | 0.068                | 7.5 × 14.5 × 26.5                  | B32023B3683M***                             | 2200                     | 2000             | 2280                |
|                    | 0.082                | 8.5 × 16.5 × 26.5                  | B32023A3823+***                             | 1920                     | 2000             | 2040                |
|                    | 0.10                 | 8.5 × 16.5 × 26.5                  | B32023A3104M***                             | 1920                     | 2000             | 2040                |
|                    | 0.10                 | 10.5 × 16.5 × 26.5                 | B32023B3104+***                             | 1560                     | 1600             | 2160                |
|                    | 0.15                 | 10.5 × 18.5 × 26.5                 | B32023A3154M***                             | 1560                     | 1600             | 2160                |
|                    | 0.15                 | 10.5 × 20.5 × 26.5                 | B32023B3154+***                             | —                        | —                | 2160                |
|                    | 0.22                 | 12.0 × 22.0 × 26.5                 | B32023A3224M***                             | —                        | —                | 1800                |
|                    | 0.22                 | 14.5 × 29.5 × 26.5                 | B32023B3224+***                             | —                        | —                | 1040                |
|                    | 0.33                 | 14.5 × 29.5 × 26.5                 | B32023A3334+***                             | —                        | —                | 1040                |
|                    | 0.39                 | 14.5 × 29.5 × 26.5                 | B32023A3394M***                             | —                        | —                | 1040                |
| 27.5               | 0.15                 | 11.0 × 19.0 × 31.5                 | B32024A3154+***                             | —                        | 1400             | 1280                |
|                    | 0.22                 | 11.0 × 19.0 × 31.5                 | B32024A3224M***                             | —                        | 1400             | 1280                |
|                    | 0.22                 | 11.0 × 21.0 × 31.5                 | B32024B3224+***                             | —                        | 1400             | 1280                |
|                    | 0.33                 | 13.5 × 23.0 × 31.5                 | B32024A3334M***                             | —                        | 1000             | 1040                |
|                    | 0.33                 | 14.0 × 24.5 × 31.5                 | B32024B3334+***                             | —                        | —                | 1040                |
|                    | 0.47                 | 15.0 × 24.5 × 31.5                 | B32024A3474M***                             | —                        | —                | 960                 |
|                    | 0.47                 | 16.0 × 32.0 × 31.5                 | B32024C3474+***                             | —                        | —                | 880                 |

MOQ = Minimum Order Quantity, consisting of 4 packing units.

Further intermediate capacitance values on request.

#### Composition of ordering code

+ = Capacitance tolerance code:

M = ±20%

K = ±10%

\*\*\* = Packaging code:

289 = Straight terminals, Ammo pack

189 = Straight terminals, Reel

003 = Straight terminals, untaped  
(lead length 3.2 ±0.3 mm)

000 = Straight terminals, untaped  
(lead length 6 – 1 mm)

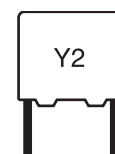

### Ordering codes and packing units

| Lead spacing<br>mm | C <sub>R</sub><br>μF | Max. dimensions<br>w × h × l<br>mm | Ordering code<br>(composition see<br>below) | Ammo<br>pack<br>pcs./MOQ | Reel<br>pcs./MOQ | Untaped<br>pcs./MOQ |
|--------------------|----------------------|------------------------------------|---|--------------------------|------------------|---------------------|
| 27.5               | 0.47                 | 18.0 × 27.5 × 31.5                 | B32024B3474+***                             | —                        | —                | 800                 |
|                    | 0.56                 | 16.0 × 32.0 × 31.5                 | B32024A3564+***                             | —                        | —                | 880                 |
|                    | 0.68                 | 18.0 × 33.0 × 31.5                 | B32024B3684+***                             | —                        | —                | 800                 |
|                    | 0.68                 | 19.0 × 30.0 × 31.5                 | B32024A3684M***                             | —                        | —                | 720                 |
|                    | 0.68                 | 21.0 × 31.0 × 31.5                 | B32024C3684+***                             | —                        | —                | 720                 |
|                    | 0.82                 | 22.0 × 36.5 × 31.5                 | B32024A3824+***                             | —                        | —                | 640                 |
|                    | 1.0                  | 22.0 × 36.5 × 31.5                 | B32024A3105M***                             | —                        | —                | 640                 |
| 37.5               | 0.33                 | 12.0 × 22.0 × 41.5                 | B32026A3334+***                             | —                        | —                | 1620                |
|                    | 0.47                 | 14.0 × 25.0 × 41.5                 | B32026A3474+***                             | —                        | —                | 1380                |
|                    | 0.56                 | 14.0 × 25.0 × 41.5                 | B32026A3564M***                             | —                        | —                | 1380                |
|                    | 0.56                 | 16.0 × 28.5 × 41.5                 | B32026B3564+***                             | —                        | —                | 800                 |
|                    | 0.68                 | 16.0 × 28.5 × 41.5                 | B32026A3684+***                             | —                        | —                | 800                 |
|                    | 0.82                 | 16.0 × 28.5 × 41.5                 | B32026A3824M***                             | —                        | —                | 800                 |
|                    | 0.82                 | 18.0 × 32.5 × 41.5                 | B32026B3824+***                             | —                        | —                | 720                 |
|                    | 1.0                  | 18.0 × 32.5 × 41.5                 | B32026A3105M***                             | —                        | —                | 720                 |
|                    | 1.0                  | 20.0 × 39.5 × 42.0                 | B32026B3105+***                             | —                        | —                | 640                 |

MOQ = Minimum Order Quantity, consisting of 4 packing units.

Further intermediate capacitance values on request.

#### Composition of ordering code

+ = Capacitance tolerance code:

M = ±20%

K = ±10%

\*\*\* = Packaging code:

289 = Straight terminals, Ammo pack

189 = Straight terminals, Reel

003 = Straight terminals, untaped  
(lead length 3.2 ±0.3 mm)

000 = Straight terminals, untaped  
(lead length 6 – 1 mm)



B32021 ... B32026

Y2 / 300 V AC

### Technical data

Reference standard: IEC 60384-14:2013/AMD1:2016.

All data given at T = 20 °C, unless otherwise specified.

|   |   |                          |                          |
|---|---|--------------------------|--------------------------|
| Rated AC voltage (IEC 60384-14:2013)  | 300 V (50/60 Hz)  |                          |                          |
| Maximum continuous DC voltage V <sub>DC</sub>   | 1500 V at T <sub>op</sub> ≤ 85 °C<br>1.5% / °C derating when 85 °C < T <sub>op</sub> ≤ 110 °C |                          |                          |
| Maximum continuous AC voltage V <sub>AC</sub><br>at T <sub>op</sub> ≤ 85 °C   | 480 V (50/60 Hz)  |                          |                          |
| Max. operating temperature T <sub>op,max</sub>  | +110 °C   |                          |                          |
| DC test voltage   | 4000 V (C ≤ 0.33 μF), 3700 V (C > 0.33 μF), 2 s   |                          |                          |
| <i>The repetition of this DC voltage test may damage the capacitor. Special care must be taken in case of use several capacitors in a parallel configuration.</i>                         |   |                          |                          |
| Dissipation factor tan δ (in 10 <sup>-3</sup> )<br>at 20 °C (upper limit values)  |   | C <sub>R</sub> ≤ 0.33 μF | C <sub>R</sub> > 0.33 μF |
|   | at 1 kHz  | 1                        | 1                        |
| Insulation resistance R <sub>ins</sub> or time constant<br>τ = C <sub>R</sub> · R <sub>ins</sub> at 100 V DC, 20 °C,<br>rel. humidity ≤ 65% and for 60 s<br>(minimum as-delivered values) | C <sub>R</sub> ≤ 0.33 μF  |                          | C <sub>R</sub> > 0.33 μF |
|   | 100 000 MΩ  |                          | 30 000 s                 |
| Passive flammability category   | B   |                          |                          |
| Capacitance tolerances (measured at 1 kHz)  | ±10% (K), ±20% (M)  |                          |                          |

### Pulse handling capability

"dV/dt" represents the maximum permissible voltage change per unit of time for non-sinusoidal voltages, expressed in V/μs.

"k<sub>0</sub>" represents the maximum permissible pulse characteristic of the waveform applied to the capacitor, expressed in V<sup>2</sup>/μs.

*Note:*

*The values of dV/dt and k<sub>0</sub> provided below must not be exceeded in order to avoid damaging the capacitor.*

### dV/dt and k<sub>0</sub> values

| Lead spacing                         | 10 mm   | 15 mm   | 22.5 mm | 27.5 mm | 37.5 mm |
|--------------------------------------|---------|---------|---------|---------|---------|
| dV/dt in V/μs                        | 800     | 600     | 500     | 400     | 300     |
| k <sub>0</sub> in V <sup>2</sup> /μs | 677 000 | 508 000 | 423 000 | 338 000 | 254 000 |





## Testing and Standards

| Test                         | Reference                               | Conditions of test  | Performance requirements   |
|------------------------------|---|---|--|
| Electrical parameters        | IEC 60384-14:2013/<br>AMD1:2016         | Voltage Proof:<br>Between terminals,<br>1500 V AC, 1 min.<br>Terminals and enclosure:<br>2 V <sub>R</sub> + 1500 V AC<br>Insulation resistance, R <sub>ins</sub><br>Capacitance, C<br>Dissipation factor, tan δ | Within specified limits  |
| Robustness of terminations   | IEC 60068-2-21:2006                     | Tensile strength (test Ua1)<br>Wire diameter   Tensile force<br>0.5 < d <sub>1</sub> ≤ 0.8 mm   10 N<br>0.8 < d <sub>1</sub> ≤ 1.25 mm   20 N   | Capacitance and tan δ within specified limits  |
| Resistance to soldering heat | IEC 60068-2-20:2008, test Tb, method 1A | Solder bath temperature at 260 ± 5 °C, immersion for 10 seconds   | ΔC/C <sub>0</sub> ≤ 5%<br>tan δ within specified limits  |
| Rapid change of temperature  | IEC 60384-14:2013/<br>AMD1:2016         | T <sub>A</sub> = lower category temperature<br>T <sub>B</sub> = upper category temperature<br>Five cycles, duration t = 30 min.   | No visible damage<br> ΔC/C <sub>0</sub>   ≤ 5%<br>tan δ within specified limits  |
| Vibration                    | IEC 60384-14:2013/<br>AMD1:2016         | Test F <sub>C</sub> : vibration sinusoidal<br>Displacement: 0.75 mm<br>Acceleration: 98 m/s <sup>2</sup><br>Frequency: 10 Hz ... 500 Hz<br>Test duration: 3 orthogonal axes, 2 hours each axe                   | No visible damage  |
| Bump                         | IEC 60384-14:2013/<br>AMD1:2016         | Test Eb: Total 4000 bumps with 400 m/s <sup>2</sup> mounted on PCB<br>6 ms duration   | No visible damage<br> ΔC/C <sub>0</sub>   ≤ 5%<br>tan δ within specified limits  |
| Climatic sequence            | IEC 60384-14:2013/<br>AMD1:2016         | Dry heat Tb / 16 h<br>Damp heat cyclic, 1 <sup>st</sup> cycle<br>+55 °C / 24 h / 95% ... 100% RH<br>Cold Ta / 2 h<br>Damp heat cyclic, 5 cycles<br>+55 °C / 24 h / 95% ... 100% RH                              | No visible damage<br> ΔC/C <sub>0</sub>   ≤ 5%<br> Δ tan δ  ≤ 0.008 for C ≤ 1 μF<br> Δ tan δ  ≤ 0.005 for C > 1 μF<br>Voltage proof<br>R <sub>ins</sub> ≥ 50% of initial limit |



B32021 ... B32026

Y2 / 300 V AC

| Test                      | Reference                          | Conditions of test  | Performance requirements   |
|---------------------------|------------------------------------|---|--|
| Damp heat, steady state   | IEC<br>60384-14:2013/<br>AMD1:2016 | Test Ca<br>40 °C / 93% RH / 56 days   | No visible damage<br>$ \Delta C/C_0  \leq 5\%$<br>$ \Delta \tan \delta  \leq 0.008$ for $C \leq 1 \mu\text{F}$<br>$ \Delta \tan \delta  \leq 0.005$ for $C > 1 \mu\text{F}$<br>Voltage proof<br>$R_{\text{ins}} \geq 50\%$ of initial limit  |
| Impulse test<br>Endurance | IEC<br>60384-14:2013/<br>AMD1:2016 | 3 impulses<br>$T_b / 1.7 V_R / 1000$ hours,<br>$1000 V_{\text{RMS}}$ for 0.1 s every hour | No visible damage<br>$ \Delta C/C_0  \leq 10\%$<br>$ \Delta \tan \delta  \leq 0.008$ for $C \leq 1 \mu\text{F}$<br>$ \Delta \tan \delta  \leq 0.005$ for $C > 1 \mu\text{F}$<br>Voltage proof<br>$R_{\text{ins}} \geq 50\%$ of initial limit |
| Passive flammability      | IEC<br>60384-14:2013/<br>AMD1:2016 | Flame applied for a period of time depending on capacitor volume                          | B  |
| Active flammability       | IEC<br>60384-14:2013/<br>AMD1:2016 | 20 discharges at $2.5 \text{ kV} + V_R$   | The cheesecloth shall not burn with a flame  |



## Mounting guidelines

### 1 Soldering

#### 1.1 Solderability of leads

The solderability of terminal leads is tested to IEC 60068-2-20:2008, test Ta, method 1.

Before a solderability test is carried out, terminals are subjected to accelerated ageing (to IEC 60068-2-2:2007, test Ba: 4 h exposure to dry heat at 155 °C). Since the ageing temperature is far higher than the upper category temperature of the capacitors, the terminal wires should be cut off from the capacitor before the ageing procedure to prevent the solderability being impaired by the products of any capacitor decomposition that might occur.

|                         |   |
|-------------------------|---|
| Solder bath temperature | 235 ±5 °C   |
| Soldering time          | 2.0 ±0.5 s  |
| Immersion depth         | 2.0 +0/−0.5 mm from capacitor body or seating plane             |
| Evaluation criteria:    |   |
| Visual inspection       | Wetting of wire surface by new solder ≥90%, free-flowing solder |

#### 1.2 Resistance to soldering heat

Resistance to soldering heat is tested to IEC 60068-2-20:2008, test Tb, method 1.

Conditions:

| Series  | Solder bath temperature | Soldering time   |
|---|-------------------------|--|
| MKT boxed (except 2.5 × 6.5 × 7.2 mm)<br>coated<br>uncoated (lead spacing >10 mm) | 260 ±5 °C               | 10 ±1 s  |
| MFP<br>MKP (lead spacing >7.5 mm)   |                         |  |
| MKT boxed (case 2.5 × 6.5 × 7.2 mm)   |                         | 5 ±1 s   |
| MKP (lead spacing ≤7.5 mm)  |                         | <4 s   |
| MKT uncoated (lead spacing ≤10 mm)<br>insulated (B32559)                          |                         | recommended soldering profile for MKT uncoated (lead spacing ≤ 10 mm) and insulated (B32559) |



B32021 ... B32026

Y2 / 300 V AC

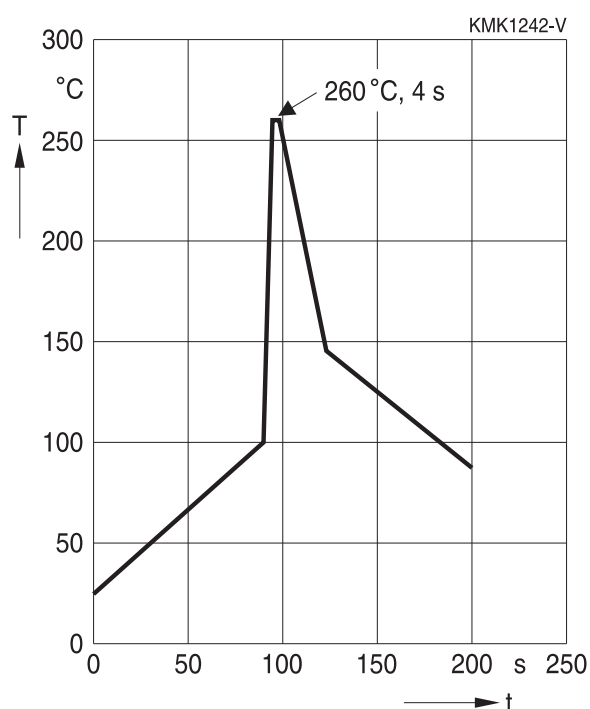

|                      |   |
|----------------------|---|
| Immersion depth      | 2.0 +0/−0.5 mm from capacitor body or seating plane                                 |
| Shield               | Heat-absorbing board, (1.5 ±0.5) mm thick, between capacitor body and liquid solder |
| Evaluation criteria: |   |
| Visual inspection    | No visible damage   |
| $\Delta C/C_0$       | 2% for MKT/MKP/MFP<br>5% for EMI suppression capacitors                             |
| $\tan \delta$        | As specified in sectional specification   |

### 1.3 General notes on soldering

Permissible heat exposure loads on film capacitors are primarily characterized by the upper category temperature  $T_{max}$ . Long exposure to temperatures above this type-related temperature limit can lead to changes in the plastic dielectric and thus change irreversibly a capacitor's electrical characteristics. For short exposures (as in practical soldering processes) the heat load (and thus the possible effects on a capacitor) will also depend on other factors like:

- Pre-heating temperature and time
- Forced cooling immediately after soldering
- Terminal characteristics:  
diameter, length, thermal resistance, special configurations (e.g. crimping)
- Height of capacitor above solder bath
- Shadowing by neighboring components
- Additional heating due to heat dissipation by neighboring components
- Use of solder-resist coatings

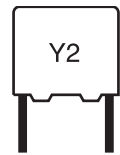

The overheating associated with some of these factors can usually be reduced by suitable countermeasures. For example, if a pre-heating step cannot be avoided, an additional or reinforced cooling process may possibly have to be included.

### Recommendations

As a reference, the recommended wave soldering profile for our film capacitors is as follows:



$T_s$ : Capacitor body maximum temperature at wave soldering

$T_p$ : Capacitor body maximum temperature at pre-heating

KMK1745-A-E

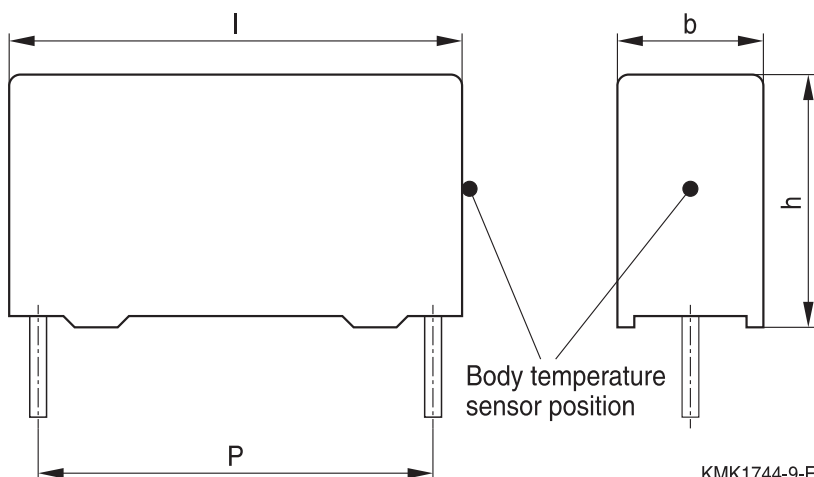

KMK1744-9-E

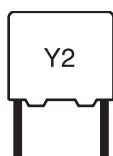

B32021 ... B32026

Y2 / 300 V AC

Body temperature should follow the description below:

- MKP capacitor
  - During pre-heating:  $T_p \leq 110 \text{ }^\circ\text{C}$
  - During soldering:  $T_s \leq 120 \text{ }^\circ\text{C}$ ,  $t_s \leq 45 \text{ s}$
- MKT capacitor
  - During pre-heating:  $T_p \leq 125 \text{ }^\circ\text{C}$
  - During soldering:  $T_s \leq 160 \text{ }^\circ\text{C}$ ,  $t_s \leq 45 \text{ s}$

When SMD components are used together with leaded ones, the film capacitors should not pass into the SMD adhesive curing oven. The leaded components should be assembled after the SMD curing step.

Leaded film capacitors are not suitable for reflow soldering.

In order to ensure proper conditions for manual or selective soldering, the body temperature of the capacitor ( $T_s$ ) must be  $\leq 120 \text{ }^\circ\text{C}$ .

One recommended condition for manual soldering is that the tip of the soldering iron should be  $< 360 \text{ }^\circ\text{C}$  and the soldering contact time should be no longer than 3 seconds.

For uncoated MKT capacitors with lead spacings  $\leq 10 \text{ mm}$  (B32560/B32561) the following measures are recommended:

- pre-heating to not more than  $110 \text{ }^\circ\text{C}$  in the preheater phase
- rapid cooling after soldering

Please refer to our Film Capacitors Data Book in case more details are needed.

### Application note

A Y capacitor to be connected between AC lines and the Frame Ground (FG) has an effect of emitting common mode current to the FG. Leak current corresponding in frequency and voltage to the AC power supply flows in the Y capacitor.

As the capacity of a Y capacitor grows, leak current also increases. This can cause electric shock. Therefore, UL and other safety standards restrict the capacity so that the amount of leak current does not exceed a certain level. Usually, two Y capacitors are used, as shown in Figure below. As AC lines are connected with capacitors, they are effective in reducing differential mode noises. In particular, they are effective for high frequency ranges of 8 to 10 MHz.

Example of EMI suppression, typical application:

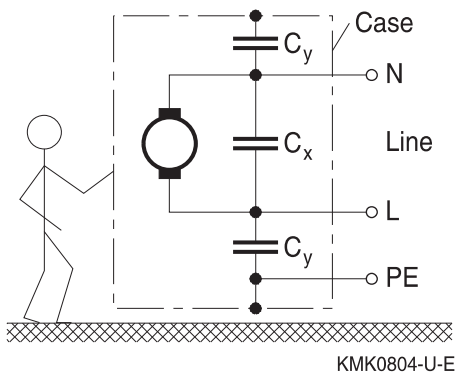
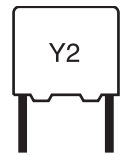



B32021 ... B32026

Y2 / 300 V AC

## Cautions and warnings

- Do not exceed the upper category temperature (UCT).
- Do not apply any mechanical stress to the capacitor terminals.
- Avoid any compressive, tensile or flexural stress.
- Do not move the capacitor after it has been soldered to the PC board.
- Do not pick up the PC board by the soldered capacitor.
- Do not place the capacitor on a PC board whose PTH hole spacing differs from the specified lead spacing.
- Do not exceed the specified time or temperature limits during soldering.
- Avoid external energy inputs, such as fire or electricity.
- Avoid overload of the capacitors.
- Consult us if application is with severe temperature and humidity condition.
- There are no serviceable or repairable parts inside the capacitor. Opening the capacitor or any attempts to open or repair the capacitor will void the warranty and liability of TDK Electronics.
- Please note that the standards referred to in this publication may have been revised in the meantime.

The table below summarizes the safety instructions that must always be observed. A detailed description can be found in the relevant sections of the chapters "General technical information" and "Mounting guidelines".

| Topic                   | Safety information  | Reference chapter<br>"General technical information" |
|-------------------------|---|--|
| Storage conditions      | Make sure that capacitors are stored within the specified range of time, temperature and humidity conditions.   | 4.5<br>"Storage conditions"                          |
| Flammability            | Avoid external energy, such as fire or electricity (passive flammability), avoid overload of the capacitors (active flammability) and consider the flammability of materials.   | 5.3<br>"Flammability"                                |
| Resistance to vibration | Do not exceed the tested ability to withstand vibration. The capacitors are tested to IEC 60068-2-6:2007. TDK Electronics offers film capacitors specially designed for operation under more severe vibration regimes such as those found in automotive applications. Consult our catalog "Film Capacitors for Automotive Electronics". | 5.2<br>"Resistance to vibration"                     |



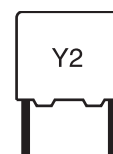

| Topic  | Safety information  | Reference chapter<br>"Mounting guidelines"         |
|--|---|--|
| Soldering                                      | Do not exceed the specified time or temperature limits during soldering.  | 1 "Soldering"                                      |
| Cleaning                                       | Use only suitable solvents for cleaning capacitors.   | 2 "Cleaning"                                       |
| Embedding of capacitors in finished assemblies | When embedding finished circuit assemblies in plastic resins, chemical and thermal influences must be taken into account.<br>Caution: Consult us first, if you also wish to embed other uncoated component types! | 3 "Embedding of capacitors in finished assemblies" |

### Design of our capacitors

Our EMI capacitors use polypropylene (PP) film metalized with a thin layer of Zinc (Zn). The following key points have made this design suitable to IEC/UL testing, holding a minimum size.

- Overvoltage AC capability with very high temperature Endurance test of IEC 60384-14:2013 (4<sup>th</sup> edition) / UL 60384-14:2014 (2<sup>nd</sup> edition) must be performed at  $1.25 \times V_R$  at maximum temperature, during 1000 hours, with a capacitance drift less than 10%.
- Higher breakdown voltage withstanding if compared to other film metallizations, like Aluminum. IEC 60384-14:2013 (4<sup>th</sup> edition) / UL 60384-14:2014 (2<sup>nd</sup> edition) establishes high voltage tests performed at  $4.3 \times V_R$  – 1 minute, impulse testing at 2500 V for  $C = 1 \mu\text{F}$  and active flammability tests.
- Damp heat steady state: 40 °C/ 93% RH / 56 days. (without voltage or current load)

### Effect of humidity on capacitance stability

Long contact of a film capacitor with humidity can produce irreversible effects. Direct contact with liquid water or excess exposure to high ambient humidity or dew will eventually remove the film metallization and thus destroy the capacitor. Plastic boxed capacitors must be properly tested in the final application at the worst expected conditions of temperature and humidity in order to check if any parameter drift may provoke a circuit malfunction.

In case of penetration of humidity through the film, the layer of Zinc can be degraded, specially under AC operation (change of polarity), accelerated by the temperature, provoking an increment of the serial resistance of the electrode and eventually a reduction of the capacitance value. For DC operation, the parameter drift is much less.

Plastic boxes and resins can not protect 100% against humidity. Metal enclosures, resin potting or coatings or similar measures by customers in their applications will offer additional protection against humidity penetration.

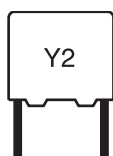

B32021 ... B32026

Y2 / 300 V AC

### Display of ordering codes for TDK Electronics products

The ordering code for one and the same product can be represented differently in data sheets, data books, other publications, on the company website, or in order-related documents such as shipping notes, order confirmations and product labels. The varying representations of the ordering codes are due to different processes employed and do not affect the specifications of the respective products.

Detailed information can be found on the Internet under [www.tdk-electronics.tdk.com/orderingcodes](http://www.tdk-electronics.tdk.com/orderingcodes).

### Correlation of data sheet values and modelling tool outputs

Data sheet values and results of design tools may deviate as they have not been derived in the same context.

While data sheets show individual parameter statements without considering a possible dependency to other parameters. Tools model a complete given scenario as input and processed inside the tool.

Furthermore as we constantly strive to improve our models, the results of tools can change over time and be a non-binding indication only.



## Symbols and terms

| Symbol               | English   | German  |
|----------------------|---|---|
| $\alpha$             | Heat transfer coefficient   | Wärmeübergangszahl  |
| $\alpha_C$           | Temperature coefficient of capacitance                                    | Temperaturkoeffizient der Kapazität   |
| A                    | Capacitor surface area  | Kondensatoroberfläche   |
| $\beta_C$            | Humidity coefficient of capacitance                                       | Feuchtekoeffizient der Kapazität  |
| C                    | Capacitance   | Kapazität   |
| $C_R$                | Rated capacitance   | Nennkapazität   |
| $\Delta C$           | Absolute capacitance change   | Absolute Kapazitätsänderung   |
| $\Delta C/C$         | Relative capacitance change (relative deviation of actual value)          | Relative Kapazitätsänderung (relative Abweichung vom Ist-Wert)                  |
| $\Delta C/C_R$       | Capacitance tolerance (relative deviation from rated capacitance)         | Kapazitätstoleranz (relative Abweichung vom Nennwert)                           |
| dt                   | Time differential   | Differentielle Zeit   |
| $\Delta t$           | Time interval   | Zeitintervall   |
| $\Delta T$           | Absolute temperature change (self-heating)                                | Absolute Temperaturänderung (Selbsterwärmung)                                   |
| $\Delta \tan \delta$ | Absolute change of dissipation factor                                     | Absolute Änderung des Verlustfaktors  |
| $\Delta V$           | Absolute voltage change   | Absolute Spannungsänderung  |
| dV/dt                | Time differential of voltage function (rate of voltage rise)              | Differentielle Spannungsänderung (Spannungsflankensteilheit)                    |
| $\Delta V/\Delta t$  | Voltage change per time interval  | Spannungsänderung pro Zeitintervall   |
| E                    | Activation energy for diffusion   | Aktivierungsenergie zur Diffusion   |
| ESL                  | Self-inductance   | Eigeninduktivität   |
| ESR                  | Equivalent series resistance  | Ersatz-Serienwiderstand   |
| f                    | Frequency   | Frequenz  |
| $f_1$                | Frequency limit for reducing permissible AC voltage due to thermal limits | Grenzfrequenz für thermisch bedingte Reduzierung der zulässigen Wechselspannung |
| $f_2$                | Frequency limit for reducing permissible AC voltage due to current limit  | Grenzfrequenz für strombedingte Reduzierung der zulässigen Wechselspannung      |
| $f_r$                | Resonant frequency  | Resonanzfrequenz  |
| $F_D$                | Thermal acceleration factor for diffusion                                 | Therm. Beschleunigungsfaktor zur Diffusion                                      |
| $F_T$                | Derating factor   | Deratingfaktor  |
| i                    | Current (peak)  | Stromspitze   |
| $I_C$                | Category current (max. continuous current)                                | Kategoriestrom (max. Dauerstrom)  |



B32021 ... B32026

Y2 / 300 V AC

| Symbol           | English  | German  |
|------------------|--|---|
| $I_{RMS}$        | (Sinusoidal) alternating current, root-mean-square value | (Sinusförmiger) Wechselstrom                      |
| $i_z$            | Capacitance drift  | Inkonstanz der Kapazität                          |
| $k_0$            | Pulse characteristic                                     | Impuls Kennwert                                   |
| $L_S$            | Series inductance  | Serieninduktivität                                |
| $\lambda$        | Failure rate   | Ausfallrate                                       |
| $\lambda_0$      | Constant failure rate during useful service life         | Konstante Ausfallrate in der Nutzungsphase        |
| $\lambda_{test}$ | Failure rate, determined by tests                        | Experimentell ermittelte Ausfallrate              |
| $P_{diss}$       | Dissipated power   | Abgegebene Verlustleistung                        |
| $P_{gen}$        | Generated power  | Erzeugte Verlustleistung                          |
| $Q$              | Heat energy  | Wärmeenergie                                      |
| $\rho$           | Density of water vapor in air                            | Dichte von Wasserdampf in Luft                    |
| $R$              | Universal molar constant for gases                       | Allg. Molarkonstante für Gas                      |
| $R$              | Ohmic resistance of discharge circuit                    | Ohmscher Widerstand des Entladekreises            |
| $R_i$            | Internal resistance                                      | Innenwiderstand                                   |
| $R_{ins}$        | Insulation resistance                                    | Isolationswiderstand                              |
| $R_P$            | Parallel resistance                                      | Parallelwiderstand                                |
| $R_S$            | Series resistance  | Serienwiderstand                                  |
| $S$              | severity (humidity test)                                 | Schärfegrad (Feuchtetest)                         |
| $t$              | Time   | Zeit  |
| $T$              | Temperature  | Temperatur  |
| $\tau$           | Time constant  | Zeitkonstante                                     |
| $\tan \delta$    | Dissipation factor                                       | Verlustfaktor                                     |
| $\tan \delta_D$  | Dielectric component of dissipation factor               | Dielektrischer Anteil des Verlustfaktors          |
| $\tan \delta_P$  | Parallel component of dissipation factor                 | Parallelanteil des Verlustfaktors                 |
| $\tan \delta_S$  | Series component of dissipation factor                   | Serienanteil des Verlustfaktors                   |
| $T_A$            | Temperature of the air surrounding the component         | Temperatur der Luft, die das Bauteil umgibt       |
| $T_{max}$        | Upper category temperature                               | Obere Kategorietemperatur                         |
| $T_{min}$        | Lower category temperature                               | Untere Kategorietemperatur                        |
| $t_{OL}$         | Operating life at operating temperature and voltage      | Betriebszeit bei Betriebstemperatur und -spannung |
| $T_{op}$         | Operating temperature, $T_A + \Delta T$                  | Betriebstemperatur, $T_A + \Delta T$              |
| $T_R$            | Rated temperature  | Nenntemperatur                                    |
| $T_{ref}$        | Reference temperature                                    | Referenztemperatur                                |
| $t_{SL}$         | Reference service life                                   | Referenz-Lebensdauer                              |



| Symbol      | English   | German                                      |
|-------------|---|---|
| $V_{AC}$    | AC voltage  | Wechselspannung                             |
| $V_C$       | Category voltage  | Kategorie <span>spannung</span>             |
| $V_{C,RMS}$ | Category AC voltage   | (Sinusförmige)<br>Kategorie-Wechselspannung |
| $V_{CD}$    | Corona-discharge onset voltage                              | Teilentlade-Einsatzspannung                 |
| $V_{ch}$    | Charging voltage  | Ladespannung                                |
| $V_{DC}$    | DC voltage  | Gleichspannung                              |
| $V_{FB}$    | Fly-back capacitor voltage                                  | Spannung (Flyback)                          |
| $V_i$       | Input voltage   | Eingangsspannung                            |
| $V_o$       | Output voltage  | Ausgangsspannung                            |
| $V_{op}$    | Operating voltage   | Betriebsspannung                            |
| $V_p$       | Peak pulse voltage  | Impuls-Spitzen <span>spannung</span>        |
| $V_{pp}$    | Peak-to-peak voltage Impedance                              | Spannungshub                                |
| $V_R$       | Rated voltage   | Nennspannung                                |
| $\hat{V}_R$ | Amplitude of rated AC voltage                               | Amplitude der Nenn-Wechselspannung          |
| $V_{RMS}$   | (Sinusoidal) alternating voltage,<br>root-mean-square value | (Sinusförmige) Wechselspannung              |
| $V_{SC}$    | S-correction voltage  | Spannung bei Anwendung "S-correction"       |
| $V_{sn}$    | Snubber capacitor voltage                                   | Spannung bei Anwendung<br>"Beschaltung"     |
| $Z$         | Impedance   | Scheinwiderstand                            |
| $e$         | Lead spacing  | Rastermaß                                   |

## Important notes

The following applies to all products named in this publication:

1. Some parts of this publication contain **statements about the suitability of our products for certain areas of application**. These statements are based on our knowledge of typical requirements that are often placed on our products in the areas of application concerned. We nevertheless expressly point out **that such statements cannot be regarded as binding statements about the suitability of our products for a particular customer application**. As a rule, we are either unfamiliar with individual customer applications or less familiar with them than the customers themselves. For these reasons, it is always ultimately incumbent on the customer to check and decide whether a product with the properties described in the product specification is suitable for use in a particular customer application.
2. We also point out that **in individual cases, a malfunction of electronic components or failure before the end of their usual service life cannot be completely ruled out in the current state of the art, even if they are operated as specified**. In customer applications requiring a very high level of operational safety and especially in customer applications in which the malfunction or failure of an electronic component could endanger human life or health (e.g. in accident prevention or lifesaving systems), it must therefore be ensured by means of suitable design of the customer application or other action taken by the customer (e.g. installation of protective circuitry or redundancy) that no injury or damage is sustained by third parties in the event of malfunction or failure of an electronic component.
3. **The warnings, cautions and product-specific notes must be observed.**
4. In order to satisfy certain technical requirements, **some of the products described in this publication may contain substances subject to restrictions in certain jurisdictions (e.g. because they are classed as hazardous)**. Useful information on this will be found in our Material Data Sheets on the Internet ([www.tdk-electronics.tdk.com/material](http://www.tdk-electronics.tdk.com/material)). Should you have any more detailed questions, please contact our sales offices.
5. We constantly strive to improve our products. Consequently, **the products described in this publication may change from time to time**. The same is true of the corresponding product specifications. Please check therefore to what extent product descriptions and specifications contained in this publication are still applicable before or when you place an order. We also **reserve the right to discontinue production and delivery of products**. Consequently, we cannot guarantee that all products named in this publication will always be available. The aforementioned does not apply in the case of individual agreements deviating from the foregoing for customer-specific products.
6. Unless otherwise agreed in individual contracts, **all orders are subject to our General Terms and Conditions of Supply**.

## Important notes

7. **Our manufacturing sites serving the automotive business apply the IATF 16949 standard.** The IATF certifications confirm our compliance with requirements regarding the quality management system in the automotive industry. Referring to customer requirements and customer specific requirements (“CSR”) TDK always has and will continue to have the policy of respecting individual agreements. Even if IATF 16949 may appear to support the acceptance of unilateral requirements, we hereby like to emphasize that **only requirements mutually agreed upon can and will be implemented in our Quality Management System.** For clarification purposes we like to point out that obligations from IATF 16949 shall only become legally binding if individually agreed upon.
8. The trade names EPCOS, CarXield, CeraCharge, CeraDiode, CeraLink, CeraPad, CeraPlas, CSMP, CTVS, DeltaCap, DigiSiMic, ExoCore, FilterCap, FormFit, LeaXield, MiniBlue, MiniCell, MKD, MKK, ModCap, MotorCap, PCC, PhaseCap, PhaseCube, PhaseMod, PhiCap, PowerHap, PQSine, PQvar, SIFERRIT, SIFI, SIKOREL, SilverCap, SIMDAD, SiMic, SIMID, SineFormer, SIOV, ThermoFuse, WindCap, XieldCap are **trademarks registered or pending** in Europe and in other countries. Further information will be found on the Internet at [www.tdk-electronics.tdk.com/trademarks](http://www.tdk-electronics.tdk.com/trademarks).

Release 2020-06