

# CSD87503Q3E 30-V N-Channel NexFET™ Power MOSFETs

## 1 Features

- Dual N-Ch Common Source MOSFETs
- Optimized for 5-V Gate Drive
- Low-Thermal Resistance
- Low  $Q_g$  and  $Q_{gd}$
- Lead-Free Terminal Plating
- RoHS Compliant
- Halogen Free
- SON 3.3-mm x 3.3-mm Plastic Package

## 2 Applications

- USB Type-C/PD VBus Protection
- Battery Protection
- Load Switch

## 3 Description

The CSD87503Q3E is a 30-V, 13.5-m $\Omega$ , common source, dual N-channel device designed for USB Type-C/PD and battery protection. This SON 3.3 x 3.3 mm device has low drain-to-drain on-resistance that minimizes losses and offers low component count for space constrained applications.

Top View

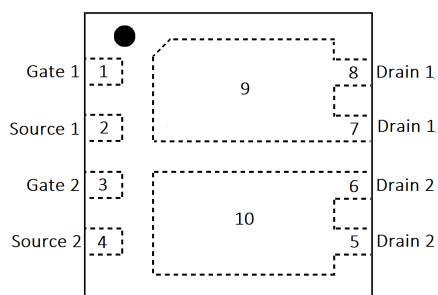

Circuit Image

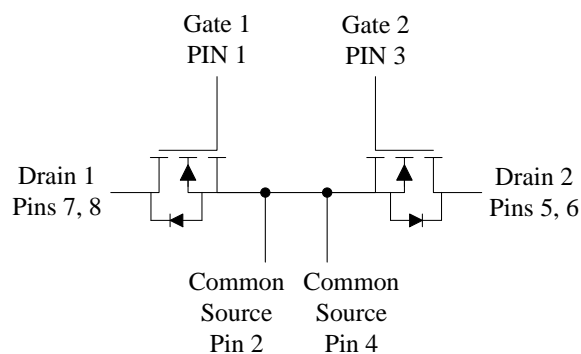

## Product Summary

$T_A = 25^\circ\text{C}$		VALUE	UNIT
$V_{DS}$	Drain-to-Source Voltage	30	V
$Q_g$	Gate Charge Total (4.5 V)	13.4	nC
$Q_{gd}$	Gate Charge Gate-to-Drain	5.8	nC
$R_{DD(on)}$	Drain-to-Drain On-Resistance	$V_{GS} = 4.5\text{ V}$	17.3
		$V_{GS} = 10\text{ V}$	13.5
$V_{GS(th)}$	Threshold Voltage	1.7	V

## Device Information<sup>(1)</sup>

DEVICE	QTY	MEDIA	PACKAGE	SHIP
CSD87503Q3E	2500	13-Inch Reel	SON	Tape and Reel
CSD87503Q3ET	250	7-Inch Reel	3.30-mm x 3.30-mm Plastic Package	Tape and Reel

(1) For all available packages, see the orderable addendum at the end of the data sheet.

## Absolute Maximum Ratings

$T_A = 25^\circ\text{C}$		VALUE	UNIT
$V_{DS}$	Drain-to-Source Voltage	30	V
$V_{GS}$	Gate-to-Source Voltage	$\pm 20$	V
$I_{D1, D2}$	Continuous Drain-to-Drain Current (Package Limited)	10	A
$I_{DS}$	Continuous Drain-to-Source Current (Package Limited)	1.5	A
$I_{D1, D2M}$	Pulsed Drain-to-Drain Current, <sup>(1)</sup>	89	A
$P_D$	Power Dissipation <sup>(2)</sup>	2.6	W
$P_D$	Power Dissipation, $T_C = 25^\circ\text{C}$	15.6	W
$T_J, T_{stg}$	Operating Junction, Storage Temperature	-55 to 150	$^\circ\text{C}$

- (1) Max  $R_{\theta JC} = 8^\circ\text{C/W}$ , pulse duration  $\leq 100\ \mu\text{s}$ , duty cycle  $\leq 1\%$ .
- (2) Typical  $R_{\theta JA} = 50^\circ\text{C/W}$  when mounted on a 1-in<sup>2</sup> (6.45-cm<sup>2</sup>), 2-oz (0.071-mm) thick Cu pad on a 0.06-in (1.52-mm) thick FR4 PCB.

$R_{DD(on)}$  VS  $V_{GS}$

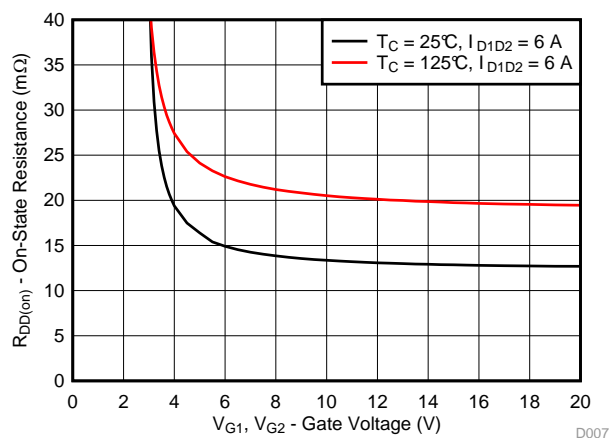

D007



## Table of Contents

<b>1 Features</b> .....	<b>1</b>	6.1 Receiving Notification of Documentation Updates ....	<b>7</b>
<b>2 Applications</b> .....	<b>1</b>	6.2 Community Resources.....	<b>7</b>
<b>3 Description</b> .....	<b>1</b>	6.3 Trademarks .....	<b>7</b>
<b>4 Revision History</b> .....	<b>2</b>	6.4 Electrostatic Discharge Caution.....	<b>7</b>
<b>5 Specifications</b> .....	<b>3</b>	6.5 Glossary .....	<b>7</b>
5.1 Electrical Characteristics.....	<b>3</b>	<b>7 Mechanical, Packaging, and Orderable Information</b> .....	<b>8</b>
5.2 Thermal Information .....	<b>3</b>	7.1 Q3 Package Dimensions .....	<b>8</b>
5.3 Typical MOSFET Characteristics.....	<b>4</b>	7.2 Recommended PCB Pattern.....	<b>9</b>
<b>6 Device and Documentation Support</b> .....	<b>7</b>	7.3 Recommended Stencil Opening .....	<b>9</b>

## 4 Revision History

DATE	REVISION	NOTES
September 2017	*	Initial release.

## 5 Specifications

### 5.1 Electrical Characteristics

 $T_A = 25^\circ\text{C}$  (unless otherwise stated)

PARAMETER		TEST CONDITIONS	MIN	TYP	MAX	UNIT	
<b>STATIC CHARACTERISTICS</b>							
$BV_{DSS}$	Drain-to-source voltage <sup>(1)</sup>	$V_{GS} = 0\text{ V}, I_D = 250\ \mu\text{A}$	30			V	
$I_{DSS}$	Drain-to-source leakage current <sup>(1)</sup>	$V_{GS} = 0\text{ V}, V_{DS} = 24\text{ V}$			1	$\mu\text{A}$	
$I_{GSS}$	Gate-to-source leakage current <sup>(1)</sup>	$V_{DS} = 0\text{ V}, V_{GS} = 20\text{ V}$			100	nA	
$V_{GS(th)}$	Gate-to-source threshold voltage <sup>(1)</sup>	$V_{DS} = V_{GS}, I_D = 250\ \mu\text{A}$	1.3	1.7	2.1	V	
$R_{DD(on)}$	Drain-to-drain on-resistance	$V_{GS} = 4.5\text{ V}, I_{D1D2} = 6\text{ A}$		17.3	21.9	m $\Omega$	
		$V_{GS} = 10\text{ V}, I_{D1D2} = 6\text{ A}$		13.5	16.9		
$g_{fs}$	Transconductance	$V_{DS} = 3\text{ V}, I_{D1D2} = 6\text{ A}$		24		S	
<b>DYNAMIC CHARACTERISTICS</b>							
$C_{ISS}$	Input capacitance	$V_{GS} = 0\text{ V}, V_{D1D2} = 15\text{ V}, f = 1\text{ MHz}$		782	1020	pF	
$C_{OSS}$	Output capacitance			157	204	pF	
$C_{RSS}$	Reverse transfer capacitance			149	194	pF	
$R_g$	Series gate resistance <sup>(1)</sup>			1.5	3.0	$\Omega$	
$Q_g$	Gate charge total (4.5 V)	$V_{D1D2} = 15\text{ V}, I_{D1D2} = 6\text{ A}$		13.4	17.4	nC	
	Gate charge total (10 V)			32.9	42.8		
$Q_{gd}$	Gate charge gate-to-drain			5.8		nC	
$Q_{gs}$	Gate charge gate-to-source			4.8		nC	
$Q_{g(th)}$	Gate charge at $V_{th}$			1.0		nC	
$Q_{OSS}$	Output charge		$V_{D1D2} = 15\text{ V}, V_{GS} = 0\text{ V}$		4.3		nC
$t_{d(on)}$	Turnon delay time		$V_{D1D2} = 15\text{ V}, V_{GS} = 10\text{ V}, I_{D1D2} = 6\text{ A}, R_G = 0\ \Omega$		10		ns
$t_r$	Rise time				40		ns
$t_{d(off)}$	Turnoff delay time			25		ns	
$t_f$	Fall time			8		ns	
<b>DIODE CHARACTERISTICS</b>							
$V_{SD}$	Diode forward voltage <sup>(1)</sup>	$I_D = 0.5\text{ A}, V_{GS} = 0\text{ V}$		0.75	0.95	V	
$Q_{rr}$	Reverse recovery charge <sup>(1)</sup>	$V_{DS} = 15\text{ V}, I_F = 6\text{ A}, di/dt = 300\text{ A}/\mu\text{s}$		9.2		nC	
$t_{rr}$	Reverse recovery time <sup>(1)</sup>			14		ns	

(1) Parameter measured on both MOSFETs individually. Table values are for a single FET.

### 5.2 Thermal Information

 $T_A = 25^\circ\text{C}$  (unless otherwise stated)

THERMAL METRIC		MIN	TYP	MAX	UNIT
$R_{\theta JC}$	Junction-to-case thermal resistance <sup>(1)</sup>			8	$^\circ\text{C}/\text{W}$
$R_{\theta JA}$	Junction-to-ambient thermal resistance <sup>(1)(2)</sup>			60	$^\circ\text{C}/\text{W}$

(1)  $R_{\theta JC}$  is determined with the device mounted on a 1-in<sup>2</sup> (6.45-cm<sup>2</sup>), 2-oz (0.071-mm) thick Cu pad on a 1.5-in × 1.5-in (3.81-cm × 3.81-cm), 0.06-in (1.52-mm) thick FR4 PCB.  $R_{\theta JC}$  is specified by design, whereas  $R_{\theta JA}$  is determined by the user's board design.

(2) Device mounted on FR4 material with 1-in<sup>2</sup> (6.45-cm<sup>2</sup>), 2-oz (0.071-mm) thick Cu.

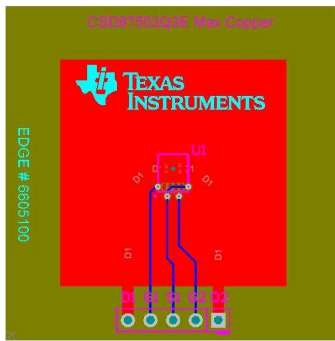

Max  $R_{\theta JA} = 60^{\circ}\text{C/W}$   
when mounted on 1 in<sup>2</sup>  
(6.45 cm<sup>2</sup>) of  
2-oz (0.071-mm) thick  
Cu.

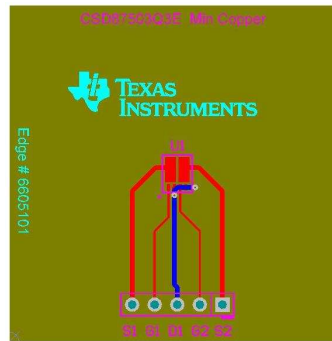

Max  $R_{\theta JA} = 185^{\circ}\text{C/W}$   
when mounted on a  
minimum pad area of  
2-oz (0.071-mm) thick  
Cu.

### 5.3 Typical MOSFET Characteristics

$T_A = 25^{\circ}\text{C}$  (unless otherwise stated)

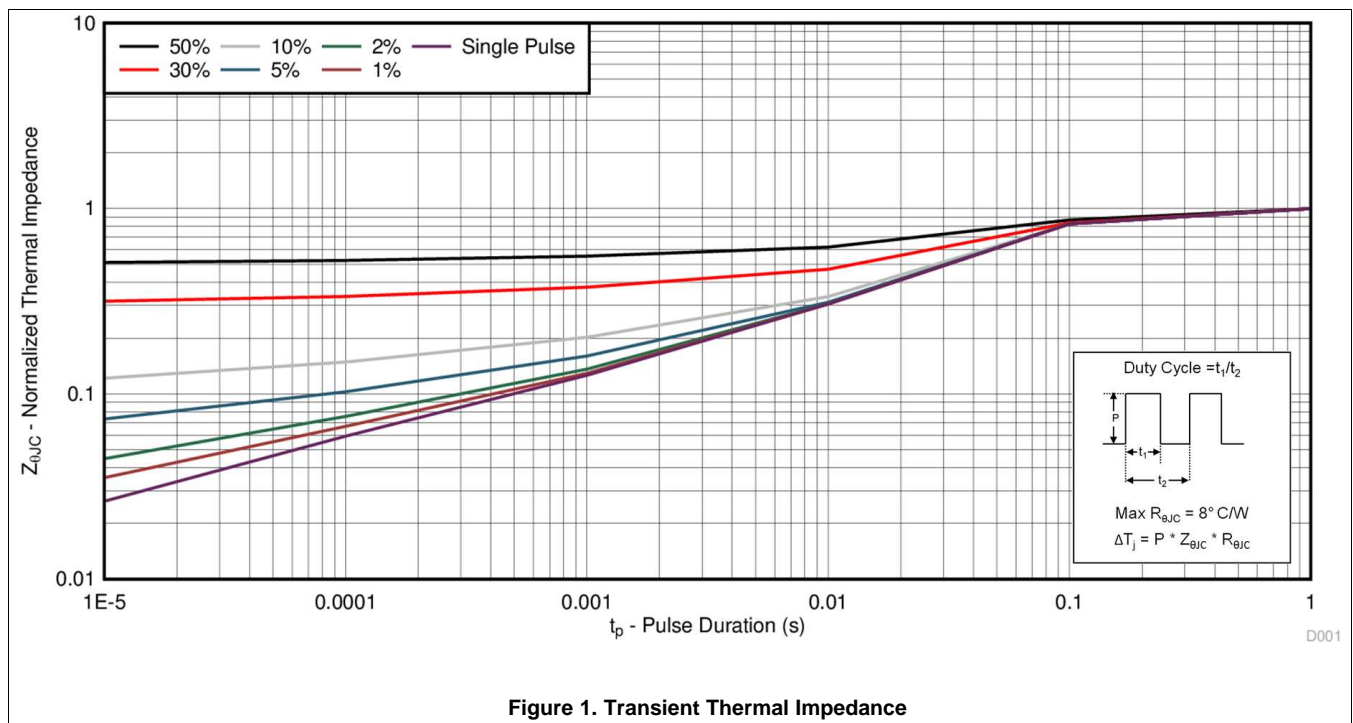

Typical MOSFET Characteristics (continued)

T<sub>A</sub> = 25°C (unless otherwise stated)

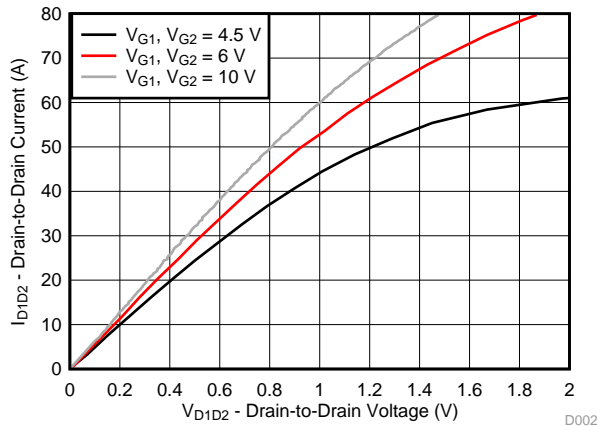

Note: Measurement taken with both gates tied together

Figure 2. Saturation Characteristics

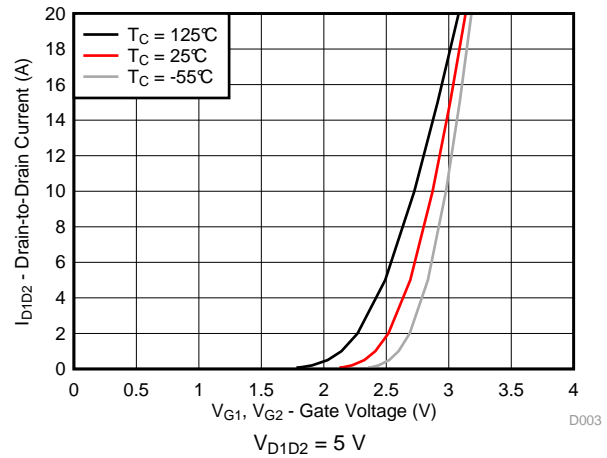

Figure 3. Transfer Characteristics

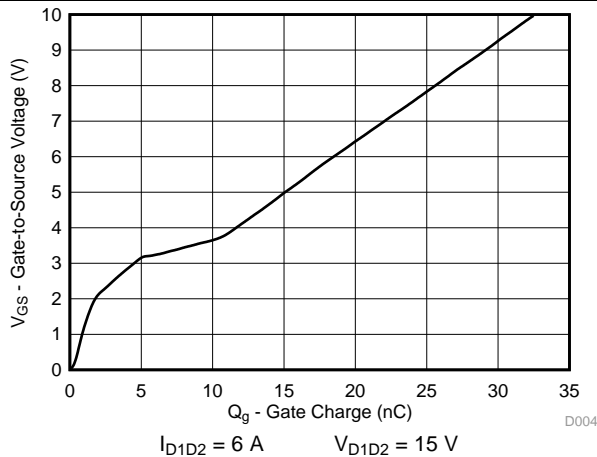

Figure 4. Gate Charge

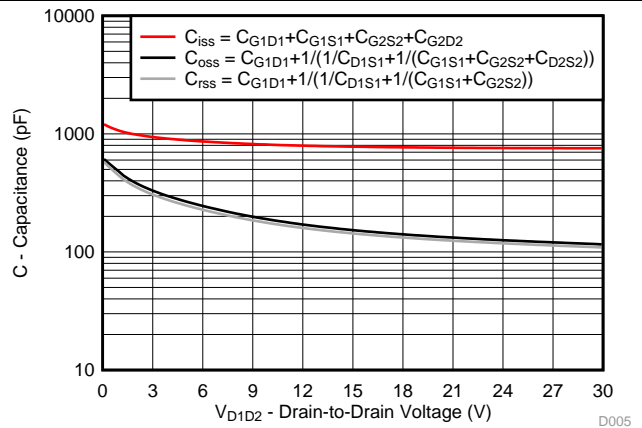

Figure 5. Capacitance

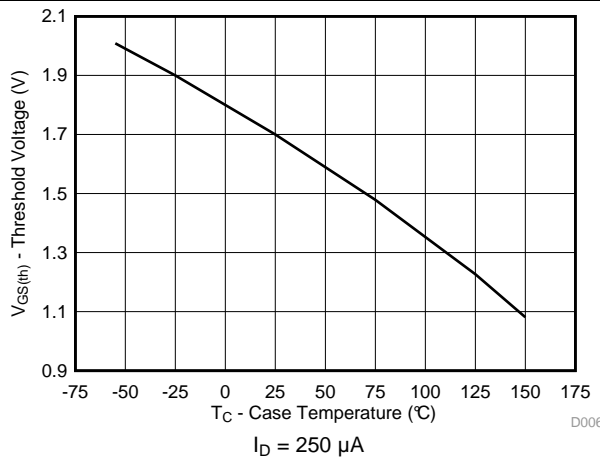

Figure 6. Threshold Voltage vs Temperature

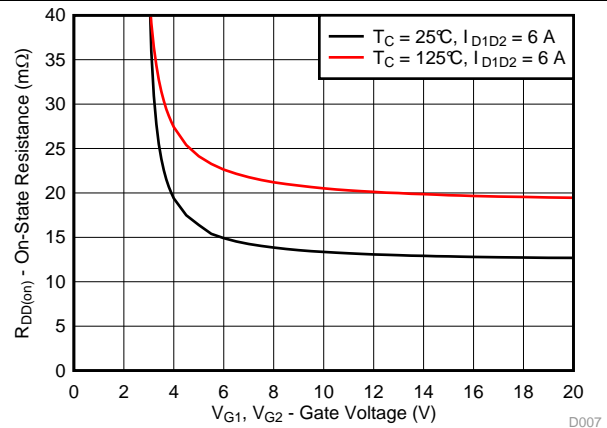

Figure 7. On-State Resistance vs Gate-to-Source Voltage

Typical MOSFET Characteristics (continued)

T<sub>A</sub> = 25°C (unless otherwise stated)

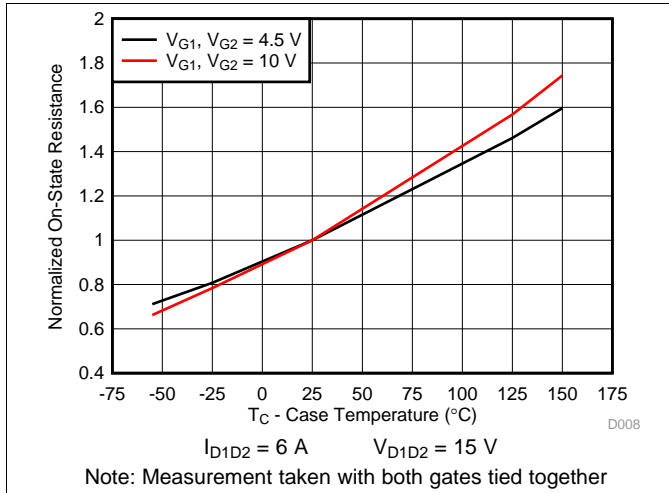

Figure 8. Normalized On-State Resistance vs Temperature

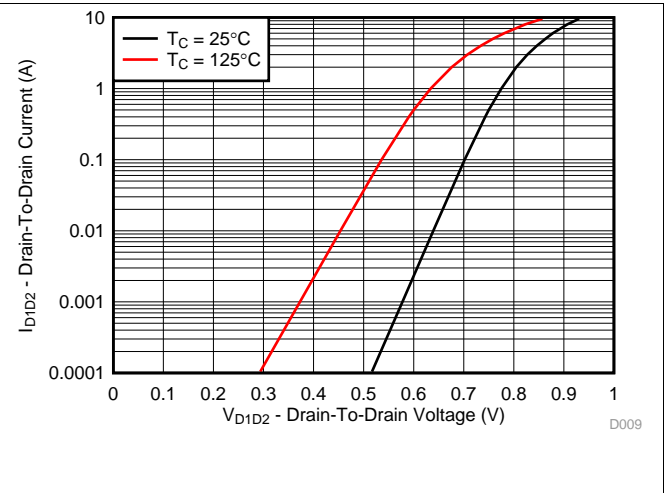

Figure 9. Typical Diode Forward Voltage

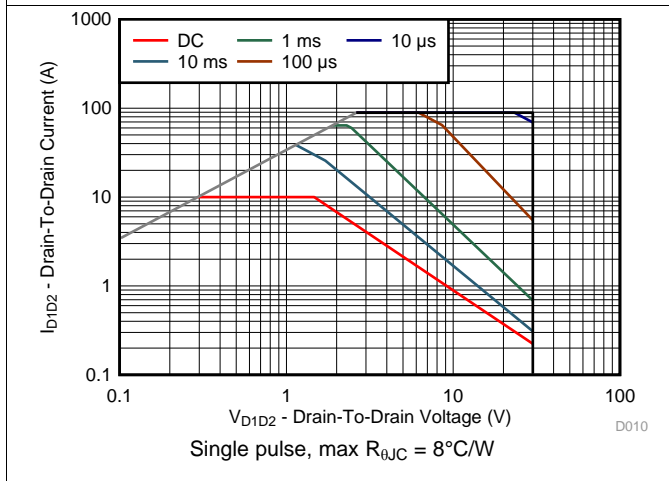

Figure 10. Maximum Safe Operating Area

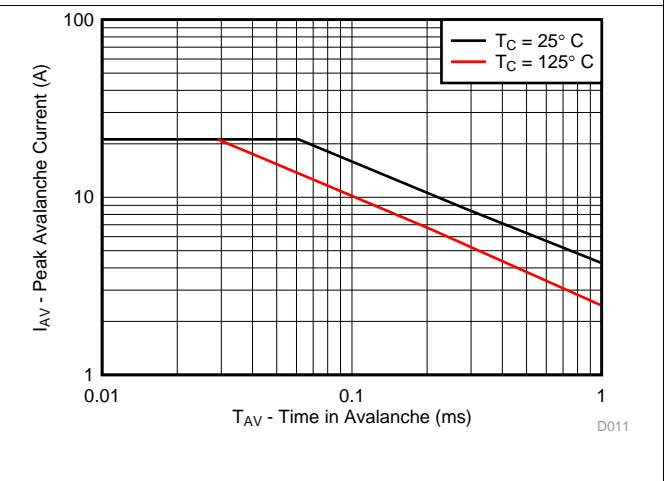

Figure 11. Single Pulse Unclamped Inductive Switching

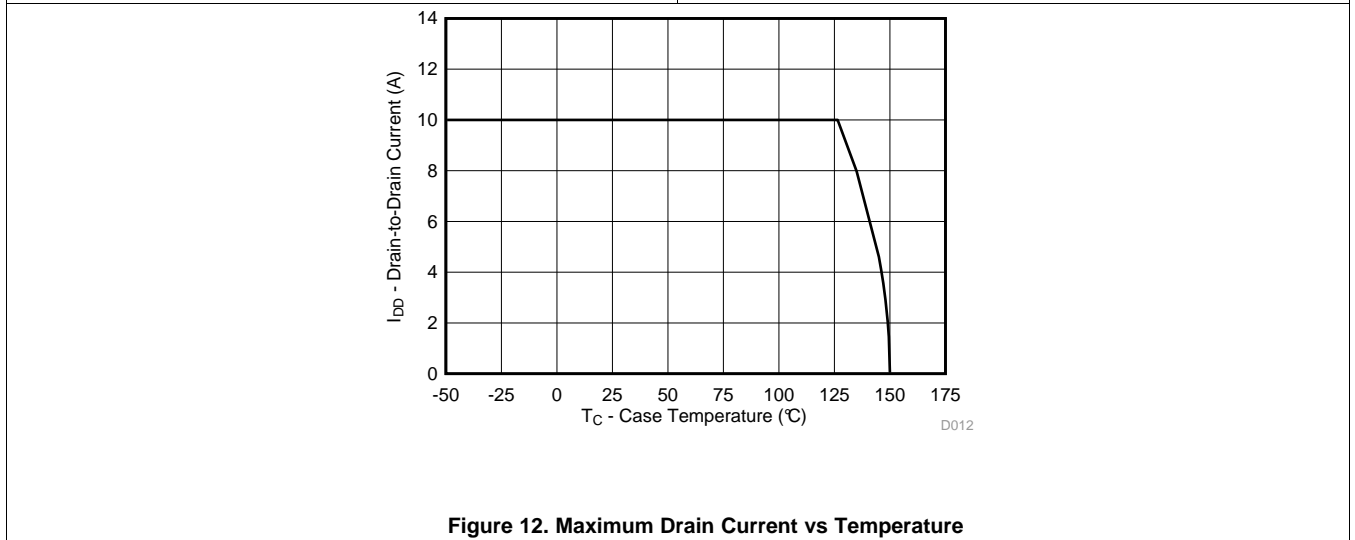

Figure 12. Maximum Drain Current vs Temperature

## 6 Device and Documentation Support

### 6.1 Receiving Notification of Documentation Updates

To receive notification of documentation updates, navigate to the device product folder on ti.com. In the upper right corner, click on *Alert me* to register and receive a weekly digest of any product information that has changed. For change details, review the revision history included in any revised document.

### 6.2 Community Resources

The following links connect to TI community resources. Linked contents are provided "AS IS" by the respective contributors. They do not constitute TI specifications and do not necessarily reflect TI's views; see TI's [Terms of Use](#).

**TI E2E™ Online Community** *TI's Engineer-to-Engineer (E2E) Community*. Created to foster collaboration among engineers. At e2e.ti.com, you can ask questions, share knowledge, explore ideas and help solve problems with fellow engineers.

**Design Support** *TI's Design Support* Quickly find helpful E2E forums along with design support tools and contact information for technical support.

### 6.3 Trademarks

E2E is a trademark of Texas Instruments.  
All other trademarks are the property of their respective owners.

### 6.4 Electrostatic Discharge Caution



These devices have limited built-in ESD protection. The leads should be shorted together or the device placed in conductive foam during storage or handling to prevent electrostatic damage to the MOS gates.

### 6.5 Glossary

[SLYZ022](#) — *TI Glossary*.

This glossary lists and explains terms, acronyms, and definitions.

## 7 Mechanical, Packaging, and Orderable Information

The following pages include mechanical, packaging, and orderable information. This information is the most current data available for the designated devices. This data is subject to change without notice and revision of this document. For browser-based versions of this data sheet, refer to the left-hand navigation.

### 7.1 Q3 Package Dimensions

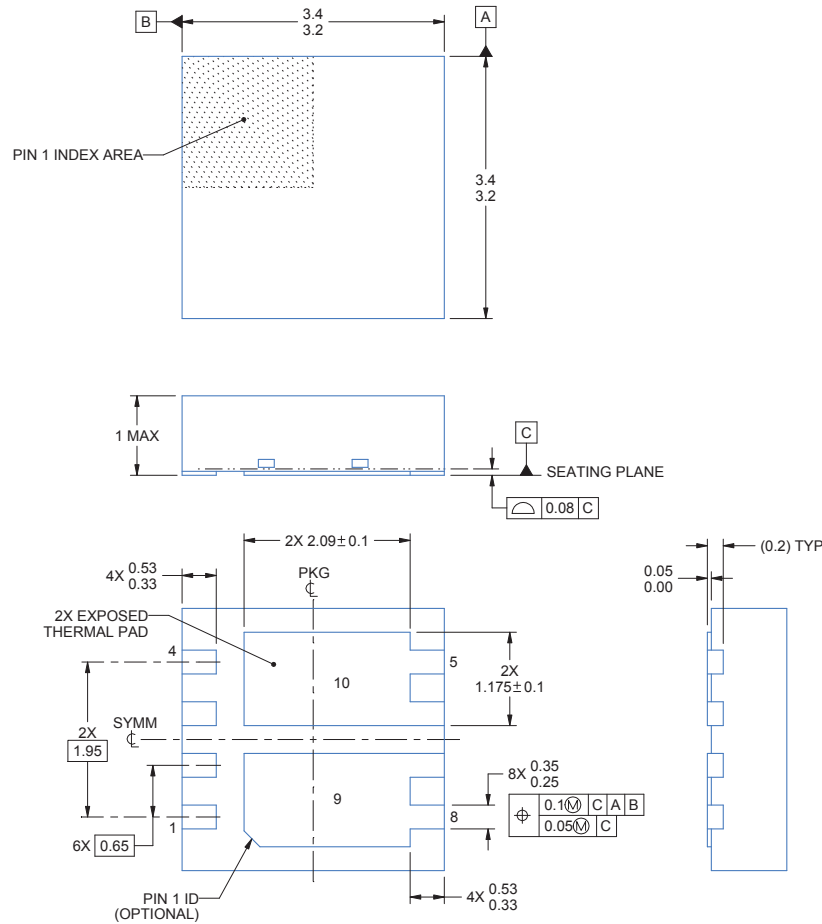

4223409/A 12/2016

1. All linear dimensions are in millimeters. Any dimensions in parenthesis are for reference only. Dimensioning and tolerancing per ASME Y14.5M.
2. This drawing is subject to change without notice.
3. The package thermal pads must be soldered to the printed circuit board for thermal and mechanical performance.

**Table 1. Pin Configuration**

POSITION	DESIGNATION
Pin 1	Gate 1
Pin 2	Common Source
Pin 3	Gate 2
Pin 4	Common Source
Pins 5, 6	Drain 2
Pins 7, 8	Drain 1



## 7.2 Recommended PCB Pattern

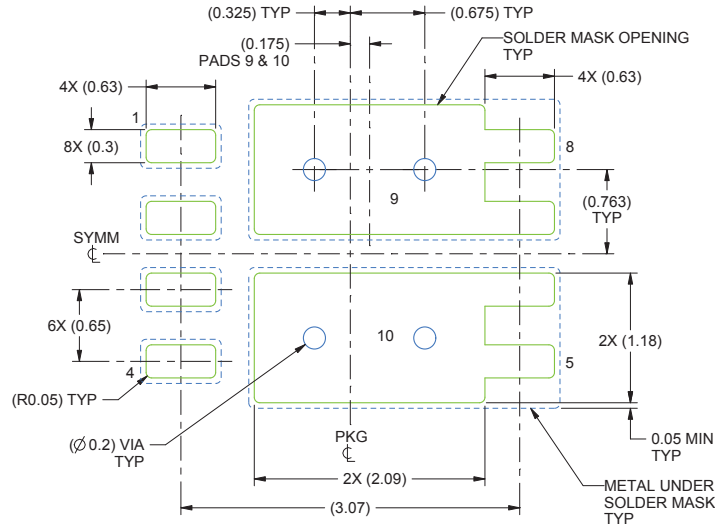

1. This package is designed to be soldered to a thermal pad on the board. For more information, see [QFN/SON PCB Attachment \(SLUA271\)](#).
2. Vias are optional depending on application, refer to device data sheet. If any vias are implemented, refer to their locations shown on this view. It is recommended that vias under paste be filled, plugged, or tented.
3. This drawing is subject to change without notice.

## 7.3 Recommended Stencil Opening

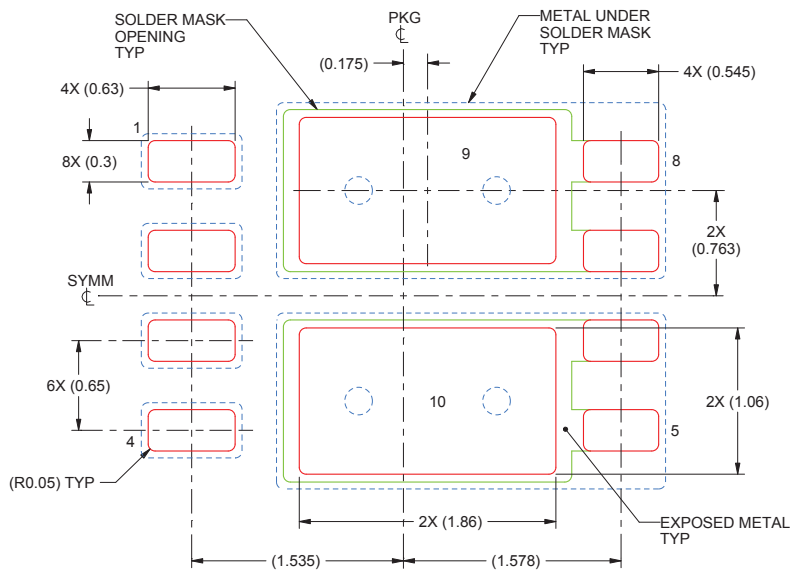

SOLDER PASTE EXAMPLE  
BASED ON 0.125 mm THICK STENCIL

EXPOSED PADS 9 & 10  
80% PRINTED SOLDER COVERAGE BY AREA UNDER PACKAGE

1. Laser cutting apertures with trapezoidal walls and rounded corners may offer better paste release. IPC-7525 may have alternate design recommendations.
2. This drawing is subject to change without notice.

**PACKAGING INFORMATION**

Orderable Device	Status (1)	Package Type	Package Drawing	Pins	Package Qty	Eco Plan (2)	Lead finish/ Ball material (6)	MSL Peak Temp (3)	Op Temp (°C)	Device Marking (4/5)	Samples
CSD87503Q3E	ACTIVE	VSON	DTD	8	2500	RoHS & Green	NIPDAU	Level-1-260C-UNLIM	-55 to 150	87503E	<a href="#">Samples</a>
CSD87503Q3ET	ACTIVE	VSON	DTD	8	250	RoHS & Green	NIPDAU	Level-1-260C-UNLIM	-55 to 150	87503E	<a href="#">Samples</a>

(1) The marketing status values are defined as follows:

**ACTIVE:** Product device recommended for new designs.

**LIFEBUY:** TI has announced that the device will be discontinued, and a lifetime-buy period is in effect.

**NRND:** Not recommended for new designs. Device is in production to support existing customers, but TI does not recommend using this part in a new design.

**PREVIEW:** Device has been announced but is not in production. Samples may or may not be available.

**OBSOLETE:** TI has discontinued the production of the device.

(2) **RoHS:** TI defines "RoHS" to mean semiconductor products that are compliant with the current EU RoHS requirements for all 10 RoHS substances, including the requirement that RoHS substance do not exceed 0.1% by weight in homogeneous materials. Where designed to be soldered at high temperatures, "RoHS" products are suitable for use in specified lead-free processes. TI may reference these types of products as "Pb-Free".

**RoHS Exempt:** TI defines "RoHS Exempt" to mean products that contain lead but are compliant with EU RoHS pursuant to a specific EU RoHS exemption.

**Green:** TI defines "Green" to mean the content of Chlorine (Cl) and Bromine (Br) based flame retardants meet JS709B low halogen requirements of <=1000ppm threshold. Antimony trioxide based flame retardants must also meet the <=1000ppm threshold requirement.

(3) MSL, Peak Temp. - The Moisture Sensitivity Level rating according to the JEDEC industry standard classifications, and peak solder temperature.

(4) There may be additional marking, which relates to the logo, the lot trace code information, or the environmental category on the device.

(5) Multiple Device Markings will be inside parentheses. Only one Device Marking contained in parentheses and separated by a "~" will appear on a device. If a line is indented then it is a continuation of the previous line and the two combined represent the entire Device Marking for that device.

(6) Lead finish/Ball material - Orderable Devices may have multiple material finish options. Finish options are separated by a vertical ruled line. Lead finish/Ball material values may wrap to two lines if the finish value exceeds the maximum column width.

**Important Information and Disclaimer:**The information provided on this page represents TI's knowledge and belief as of the date that it is provided. TI bases its knowledge and belief on information provided by third parties, and makes no representation or warranty as to the accuracy of such information. Efforts are underway to better integrate information from third parties. TI has taken and continues to take reasonable steps to provide representative and accurate information but may not have conducted destructive testing or chemical analysis on incoming materials and chemicals. TI and TI suppliers consider certain information to be proprietary, and thus CAS numbers and other limited information may not be available for release.

In no event shall TI's liability arising out of such information exceed the total purchase price of the TI part(s) at issue in this document sold by TI to Customer on an annual basis.



## TAPE AND REEL INFORMATION



### QUADRANT ASSIGNMENTS FOR PIN 1 ORIENTATION IN TAPE



\*All dimensions are nominal

Device	Package Type	Package Drawing	Pins	SPQ	Reel Diameter (mm)	Reel Width W1 (mm)	A0 (mm)	B0 (mm)	K0 (mm)	P1 (mm)	W (mm)	Pin1 Quadrant
CSD87503Q3ET	VSON	DTD	8	250	178.0	13.5	3.6	3.6	1.2	8.0	12.0	Q1

TAPE AND REEL BOX DIMENSIONS



\*All dimensions are nominal

Device	Package Type	Package Drawing	Pins	SPQ	Length (mm)	Width (mm)	Height (mm)
CSD87503Q3ET	VSON	DTD	8	250	189.0	185.0	36.0

## IMPORTANT NOTICE AND DISCLAIMER

TI PROVIDES TECHNICAL AND RELIABILITY DATA (INCLUDING DATASHEETS), DESIGN RESOURCES (INCLUDING REFERENCE DESIGNS), APPLICATION OR OTHER DESIGN ADVICE, WEB TOOLS, SAFETY INFORMATION, AND OTHER RESOURCES "AS IS" AND WITH ALL FAULTS, AND DISCLAIMS ALL WARRANTIES, EXPRESS AND IMPLIED, INCLUDING WITHOUT LIMITATION ANY IMPLIED WARRANTIES OF MERCHANTABILITY, FITNESS FOR A PARTICULAR PURPOSE OR NON-INFRINGEMENT OF THIRD PARTY INTELLECTUAL PROPERTY RIGHTS.

These resources are intended for skilled developers designing with TI products. You are solely responsible for (1) selecting the appropriate TI products for your application, (2) designing, validating and testing your application, and (3) ensuring your application meets applicable standards, and any other safety, security, or other requirements. These resources are subject to change without notice. TI grants you permission to use these resources only for development of an application that uses the TI products described in the resource. Other reproduction and display of these resources is prohibited. No license is granted to any other TI intellectual property right or to any third party intellectual property right. TI disclaims responsibility for, and you will fully indemnify TI and its representatives against, any claims, damages, costs, losses, and liabilities arising out of your use of these resources.

TI's products are provided subject to TI's Terms of Sale ([www.ti.com/legal/termsofsale.html](http://www.ti.com/legal/termsofsale.html)) or other applicable terms available either on [ti.com](http://ti.com) or provided in conjunction with such TI products. TI's provision of these resources does not expand or otherwise alter TI's applicable warranties or warranty disclaimers for TI products.

Mailing Address: Texas Instruments, Post Office Box 655303, Dallas, Texas 75265  
Copyright © 2020, Texas Instruments Incorporated