

Star Magnetics™ Gigabit Transformer Modules with PoE* Option

*Power over Ethernet

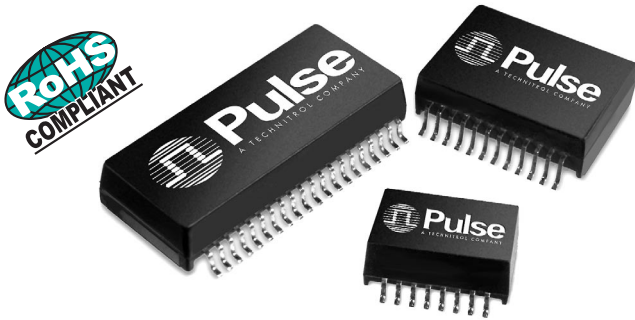

- RoHS reflow temperature rating 245° C
- Meets IEEE 802.3 specification
- Compact footprint

Electrical Specifications @ 25°C — Operating Temperature 0°C to 70°C

RoHS Compliant Part Number	PoE	Turns Ratio		Number of Ports	Insertion Loss (dB MAX)			Return Loss (Zout = 100 Ω ±15%)				Crosstalk (adjacent channels dB MIN)			Hipot (Vrms MIN)
		Tx	Rx		0.1 MHz	100 MHz	125 MHz	30 MHz	60 MHz	80 MHz	100 MHz	30 MHz	60 MHz	100 MHz	
H5062NL ^{2a}	No	1:1	1:1	1	-1.1	-1.0	-2.0	-18	-12	-12	-10	-43	-37	-33	1500
H6062NL ^{2a}	Yes	1:1	1:1	1	-1.1	-1.0	-2.0	-18	-12	-12	-10	-43	-37	-33	1500
H6080NL ^{2a}	Yes	1:1	1:1	2	-1.1	-1.0	-2.0	-18	-12	-12	-10	-43	-37	-33	1500

- For Tape & Reel packaging add a "T" suffix to the end of the part number when ordering, e.g. H5062NLT
- MSL = Moisture Sensitivity Level a=1 b=2 c=3 d=4 e=5

Mechanicals

H5062NL

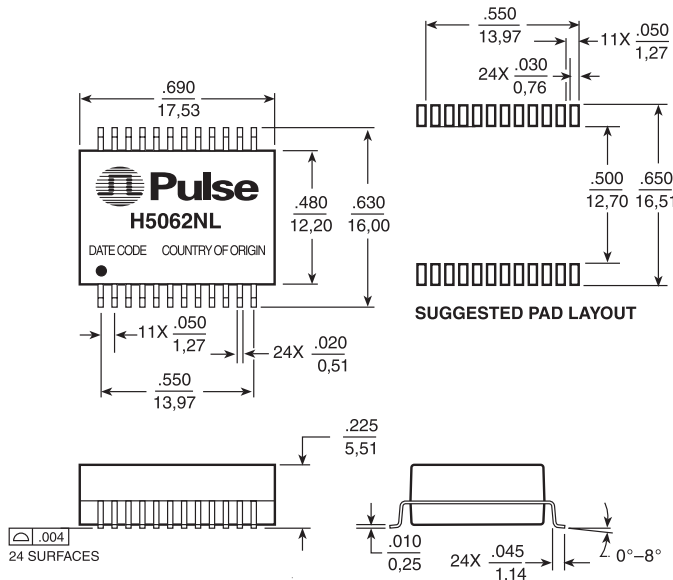

Weight 2.7 grams
 Tape & Reel 300/reel
 Tube 25/tube

H6062NL

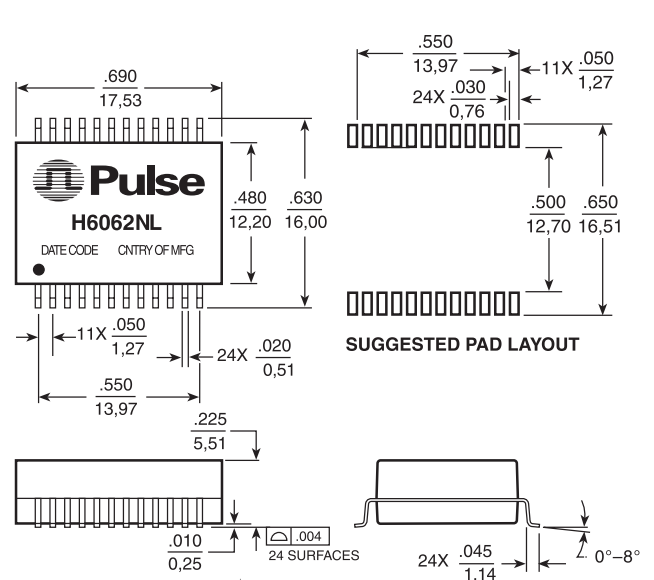

Weight 2.63 grams
 Tape & Reel 300/reel
 Tube 25

Dimensions: $\frac{\text{Inches}}{\text{mm}}$ Unless otherwise specified, all tolerances are $\pm \frac{.010}{0.25}$

Star Magnetics™ Gigabit Transformer Modules with PoE* Option

*Power over Ethernet



Mechanicals (continued)

H6080NL

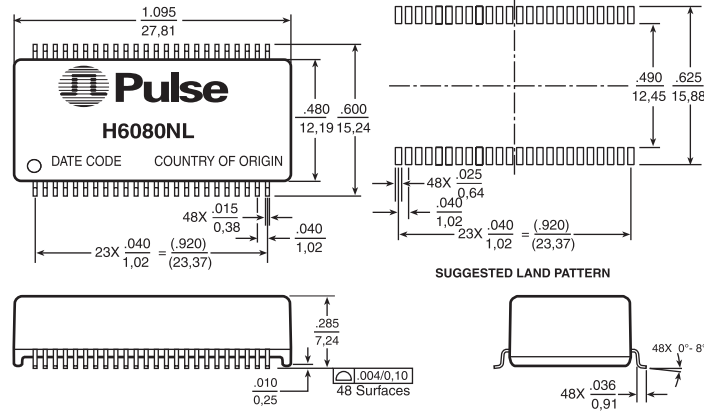

Dimensions: $\frac{\text{Inches}}{\text{mm}}$ Unless otherwise specified, all tolerances are $\pm \frac{.010}{0,25}$

Weight 4.0 grams
Tape & Reel 250/reel
Tube 15/tube

Schematics

H5062NL

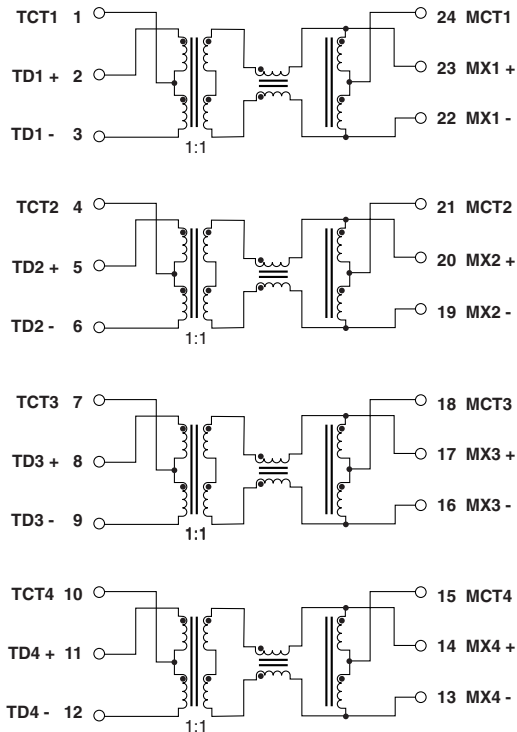

H6062NL

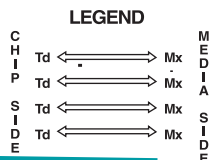
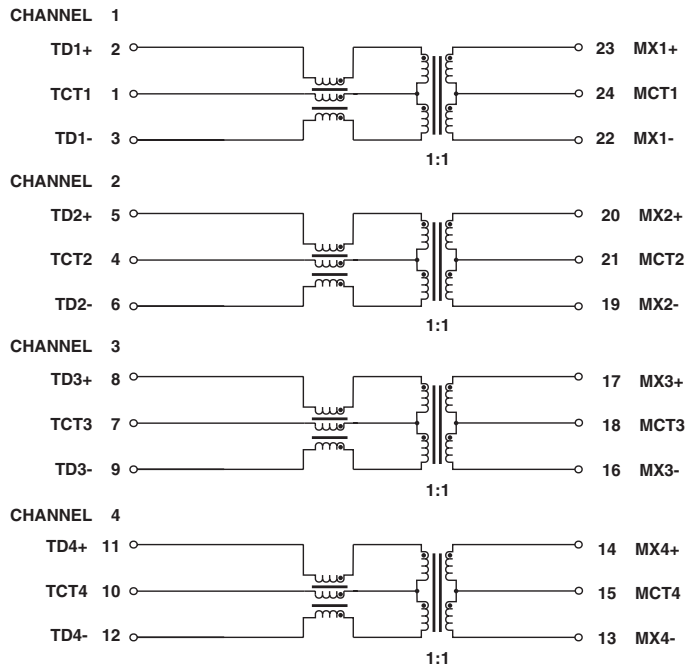

Star Magnetics™ Gigabit Transformer Modules with PoE* Option

*Power over Ethernet



Schematics (continued)

H6080NL

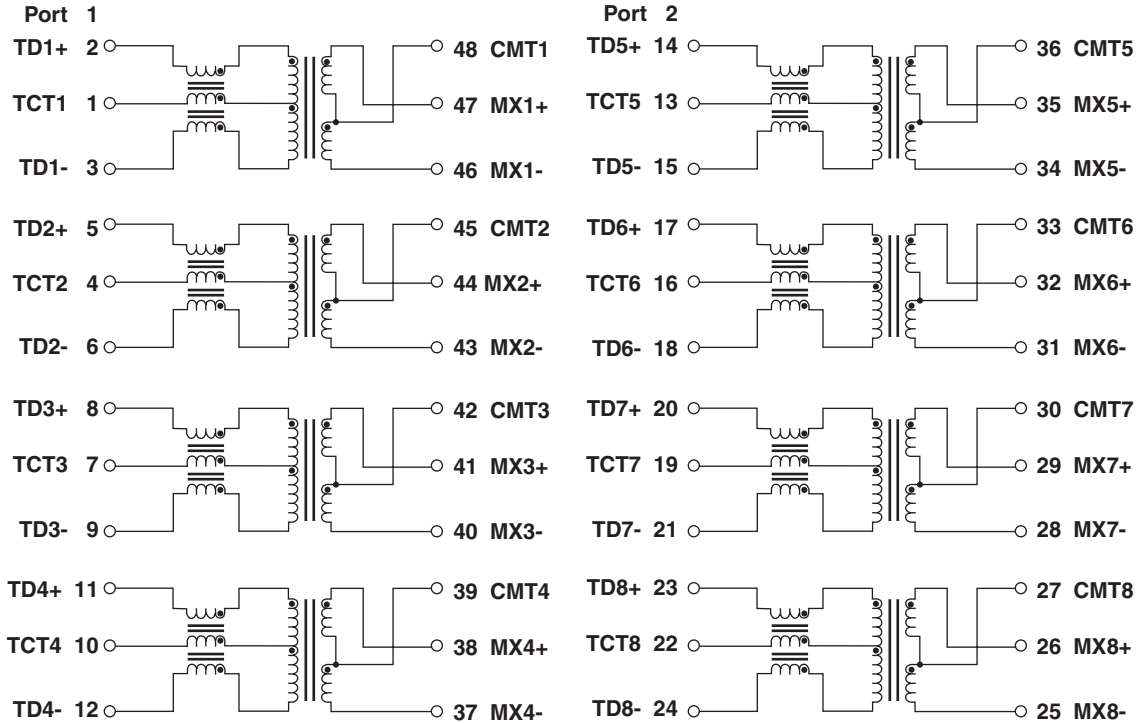

For More Information:

Pulse Worldwide Headquarters
12220 World Trade Dr.
San Diego, CA 92128
U.S.A.

Pulse Europe
Zeppelinstrasse 15
D-71083 Herrenberg
Germany

Pulse China Headquarters
B402, Shenzhen Academy of
Aerospace Technology Bldg.
10th Kejian Rd.
High-Tech Zone
Nanshan District
Shenzhen, PR China 518057

Pulse North China
Room 2704/2705
Super Ocean Finance Ctr.
2067 Yan An Rd. West
Shanghai 200336
China

Pulse South Asia
135 Joo Seng Rd.
#03-02
PM Industrial Bldg.
Singapore 368363

Pulse North Asia
3F, No. 198
Zhongyuan Rd.
Zhongli City
Taoyuan County 320
Taiwan R. O. C.

Tel: 858 674 8100
Fax: 858 674 8262

Tel: 49 7032 7806 0
Fax: 49 7032 7806 135

Tel: 86 755 33966678
Fax: 86 755 33966700

Tel: 86 21 62787060
Fax: 86 2162786973

Tel: 65 6287 8998
Fax: 65 6287 8998

Tel: 886 3 4356768
Fax: 886 3 4356823 (Pulse)
Fax: 886 3 4356820 (FRE)

Performance warranty of products offered on this data sheet is limited to the parameters specified. Data is subject to change without notice. Other brand and product names mentioned herein may be trademarks or registered trademarks of their respective owners. © Copyright, 2011. Pulse Engineering, Inc. All rights reserved.

Mouser Electronics

Authorized Distributor

Click to View Pricing, Inventory, Delivery & Lifecycle Information:

Pulse:

[H6062NLT](#) [H5062NL](#) [H6062NL](#) [H5062NLT](#) [H6080NLT](#)