

DS90C032B LVDS Quad CMOS Differential Line Receiver

Check for Samples: [DS90C032B](#)

FEATURES

- >155.5 Mbps (77.7 MHz) Switching Rates
- Accepts Small Swing (350 mV) Differential Signal Levels
- High Impedance LVDS Inputs with Power Down
- Ultra Low Power Dissipation
- 600 ps Maximum Differential Skew (5V, 25°C)
- 6.0 ns Maximum Propagation Delay
- Industrial Operating Temperature Range
- Available in Surface Mount Packaging (SOIC)
- Pin Compatible with DS26C32A, MB570 (PECL) and 41LF (PECL)
- Supports OPEN and Terminated Input Failsafe
- Conforms to ANSI/TIA/EIA-644 LVDS Standard

DESCRIPTION

The DS90C032B is a quad CMOS differential line receiver designed for applications requiring ultra low power dissipation and high data rates. The device supports data rates in excess of 155.5 Mbps (77.7 MHz) and uses Low Voltage Differential Signaling (LVDS) technology.

The DS90C032B accepts low voltage (350 mV) differential input signals and translates them to CMOS (TTL compatible) output levels. The receiver supports a TRI-STATE function that may be used to multiplex outputs. The receiver also supports OPEN Failsafe and terminated (100Ω) input Failsafe with the addition of external failsafe biasing. Receiver output will be HIGH for both Failsafe conditions.

The DS90C032B provides power-off high impedance LVDS inputs. This feature assures minimal loading effect on the LVDS bus lines when V_{CC} is not present.

The DS90C032B and companion line driver (DS90C031B) provide a new alternative to high power pseudo-ECL devices for high-speed point-to-point interface applications.

Connection Diagram

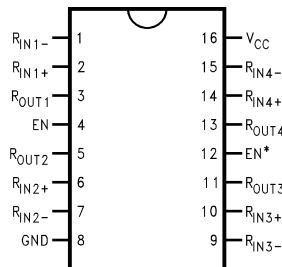
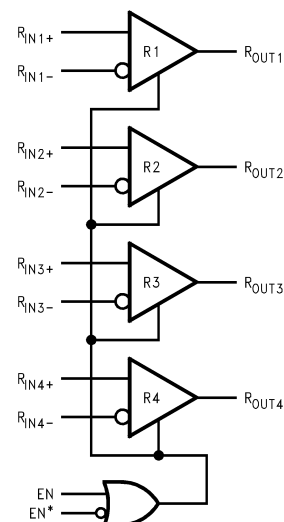

Figure 1. Dual-In-Line Top View
See Package Number D (R-PDSO-G16)

Functional Diagram



Please be aware that an important notice concerning availability, standard warranty, and use in critical applications of Texas Instruments semiconductor products and disclaimers thereto appears at the end of this data sheet.

All trademarks are the property of their respective owners.

Table 1. Receiver Truth Table

ENABLES		INPUTS	OUTPUT
EN	EN*	R _{IN+} – R _{IN-}	R _{OUT}
L	H	X	Z
All other combinations of ENABLE inputs		V _{ID} ≥ 0.1V	H
		V _{ID} ≤ -0.1V	L
		Failsafe OPEN or Terminated	H



These devices have limited built-in ESD protection. The leads should be shorted together or the device placed in conductive foam during storage or handling to prevent electrostatic damage to the MOS gates.

Absolute Maximum Ratings⁽¹⁾

Supply Voltage (V _{CC})		-0.3V to +6V
Input Voltage (R _{IN+} , R _{IN-})		-0.3V to +5.8V
Enable Input Voltage (EN, EN*)		-0.3V to (V _{CC} + 0.3V)
Output Voltage (R _{OUT})		-0.3V to (V _{CC} + 0.3V)
Maximum Package Power Dissipation at +25°C		1025 mW
Derate Power Dissipation		8.2 mW/°C above +25°C
Storage Temperature Range		-65°C to +150°C
Maximum Lead Temperature, Soldering (4 seconds)		+260°C
Maximum Junction Temperature		+150°C
ESD Ratings	HBM, 1.5 kΩ, 100 pF	≥ 2kV
	EIAJ, 0 Ω, 200 pF	≥ 250V

(1) "Absolute Maximum Ratings" are those values beyond which the safety of the device cannot be ensured. They are not meant to imply that the devices should be operated at these limits. "Electrical Characteristics" specifies conditions of device operation.

Recommended Operating Conditions

	Min	Typ	Max	Units
Supply Voltage (V _{CC})	+4.5	+5.0	+5.5	V
Receiver Input Voltage	GND		2.4	V
Operating Free Air Temperature (T _A)	-40	+25	+85	°C

Electrical Characteristics

Over Supply Voltage and Operating Temperature ranges, unless otherwise specified⁽¹⁾⁽²⁾

Symbol	Parameter	Conditions	Pin	Min	Typ	Max	Units
V _{TH}	Differential Input High Threshold	V _{CM} = +1.2V	R _{IN+} , R _{IN-}			+100	mV
V _{TL}	Differential Input Low Threshold			-100			mV
I _{IN}	Input Current	V _{IN} = +2.4V	V _{CC} = 5.5V or 0V	-10	±1	+10	µA
		V _{IN} = 0V		-10	±1	+10	µA
V _{OH}	Output High Voltage	I _{OH} = -0.4 mA, V _{ID} = +200 mV	R _{OUT}	3.8	4.9		V
		I _{OH} = -0.4 mA, Input terminated		3.8	4.9		V
V _{OL}	Output Low Voltage	I _{OL} = 2 mA, V _{ID} = -200 mV	R _{OUT}		0.07	0.3	V
I _{OS}	Output Short Circuit Current	Enabled, V _{OUT} = 0V ⁽³⁾		-15	-60	-100	mA
I _{OZ}	Output TRI-STATE Current	Disabled, V _{OUT} = 0V or V _{CC}		-10	±1	+10	µA
V _{IH}	Input High Voltage		EN, EN*	2.0			V
V _{IL}	Input Low Voltage					0.8	V
I _I	Input Current			-10	±1	+10	µA
V _{CL}	Input Clamp Voltage	I _{CL} = -18 mA		-1.5	-0.8		V
I _{CC}	No Load Supply Current, Receivers Enabled	EN, EN* = V _{CC} or GND, Inputs Open	V _{CC}		3.5	10	mA
		EN, EN* = 2.4 or 0.5, Inputs Open			3.7	11	mA
I _{CCZ}	No Load Supply Current, Receivers Disabled	EN = GND, EN* = V _{CC} , Inputs Open			3.5	10	mA

- (1) Current into device pins is defined as positive. Current out of device pins is defined as negative. All voltages are referenced to ground unless otherwise specified.
- (2) All typicals are given for: V_{CC} = +5.0V, T_A = +25°C.
- (3) Output short circuit current (I_{OS}) is specified as magnitude only, minus sign indicates direction only. Only one output should be shorted at a time, do not exceed maximum junction temperature specification.

Switching Characteristics

V_{CC} = +5.0V, T_A = +25°C⁽¹⁾⁽²⁾⁽³⁾

Symbol	Parameter	Conditions	Min	Typ	Max	Units
t _{PHLD}	Differential Propagation Delay High to Low	C _L = 5 pF, V _{ID} = 200 mV, See Figure 2 and Figure 3	1.5	3.40	5.0	ns
t _{PLHD}	Differential Propagation Delay Low to High		1.5	3.48	5.0	ns
t _{SKD}	Differential Skew t _{PHLD} - t _{PLHD}		0	80	600	ps
t _{SK1}	Channel-to-Channel Skew ⁽⁴⁾		0	0.6	1.0	ns
t _{TLH}	Rise Time			0.5	2.0	ns
t _{THL}	Fall Time			0.5	2.0	ns
t _{PHZ}	Disable Time High to Z	R _L = 2 kΩ, C _L = 10 pF, See Figure 4 and Figure 5		10	15	ns
t _{PLZ}	Disable Time Low to Z			10	15	ns
t _{PZH}	Enable Time Z to High			4	10	ns
t _{PZL}	Enable Time Z to Low			4	10	ns

- (1) All typicals are given for: V_{CC} = +5.0V, T_A = +25°C.
- (2) Generator waveform for all tests unless otherwise specified: f = 1 MHz, Z_O = 50Ω, t_r and t_f (0%–100%) ≤ 1 ns for R_{IN} and t_r and t_f ≤ 6 ns for EN or EN*.
- (3) C_L includes probe and jig capacitance.
- (4) Channel-to-Channel Skew is defined as the difference between the propagation delay of one channel and that of the others on the same chip with an event on the inputs.

Switching Characteristics

 $V_{CC} = +5.0V \pm 10\%$, $T_A = -40^\circ C$ to $+85^\circ C^{(1)(2)(3)}$

Symbol	Parameter	Conditions	Min	Typ	Max	Units
t_{PHLD}	Differential Propagation Delay High to Low	$C_L = 5\text{ pF}$, $V_{ID} = 200\text{ mV}$, See Figure 2 and Figure 3	1.0	3.40	6.0	ns
t_{PLHD}	Differential Propagation Delay Low to High		1.0	3.48	6.0	ns
t_{SKD}	Differential Skew $ t_{PHLD} - t_{PLHD} $		0	0.08	1.2	ns
t_{SK1}	Channel-to-Channel Skew ⁽⁴⁾		0	0.6	1.5	ns
t_{SK2}	Chip to Chip Skew ⁽⁵⁾				5.0	ns
t_{TLH}	Rise Time	$R_L = 2\text{ k}\Omega$, $C_L = 10\text{ pF}$, See Figure 4 and Figure 5		0.5	2.5	ns
t_{THL}	Fall Time			0.5	2.5	ns
t_{PHZ}	Disable Time High to Z			10	20	ns
t_{PLZ}	Disable Time Low to Z			10	20	ns
t_{PZH}	Enable Time Z to High			4	15	ns
t_{PZL}	Enable Time Z to Low		4	15	ns	

(1) All typicals are given for: $V_{CC} = +5.0V$, $T_A = +25^\circ C$.

(2) Generator waveform for all tests unless otherwise specified: $f = 1\text{ MHz}$, $Z_O = 50\Omega$, t_r and t_f (0%–100%) $\leq 1\text{ ns}$ for R_{IN} and t_r and $t_f \leq 6\text{ ns}$ for EN or EN*.

(3) C_L includes probe and jig capacitance.

(4) Channel-to-Channel Skew is defined as the difference between the propagation delay of one channel and that of the others on the same chip with an event on the inputs.

(5) Chip to Chip Skew is defined as the difference between the minimum and maximum specified differential propagation delays.

Parameter Measurement Information

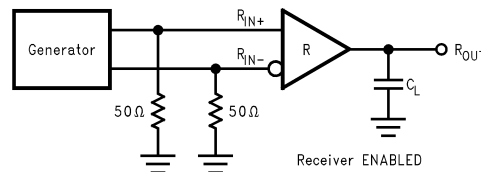

Figure 2. Receiver Propagation Delay and Transition Time Test Circuit

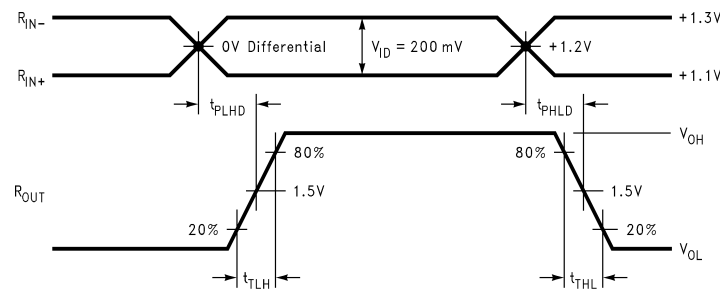
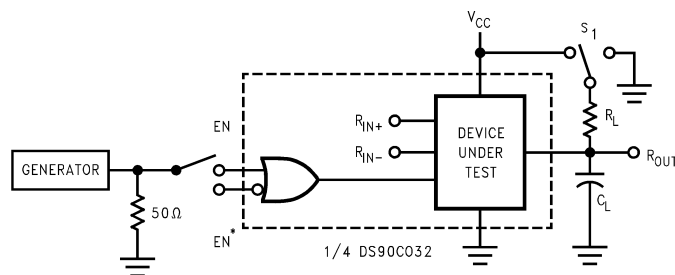

Figure 3. Receiver Propagation Delay and Transition Time Waveforms

Parameter Measurement Information (continued)



C_L includes load and test jig capacitance.
 $S_1 = V_{CC}$ for t_{PZL} and t_{PLZ} measurements.
 $S_1 = GND$ for t_{PZH} and t_{PHZ} measurements.

Figure 4. Receiver TRI-STATE Delay Test Circuit

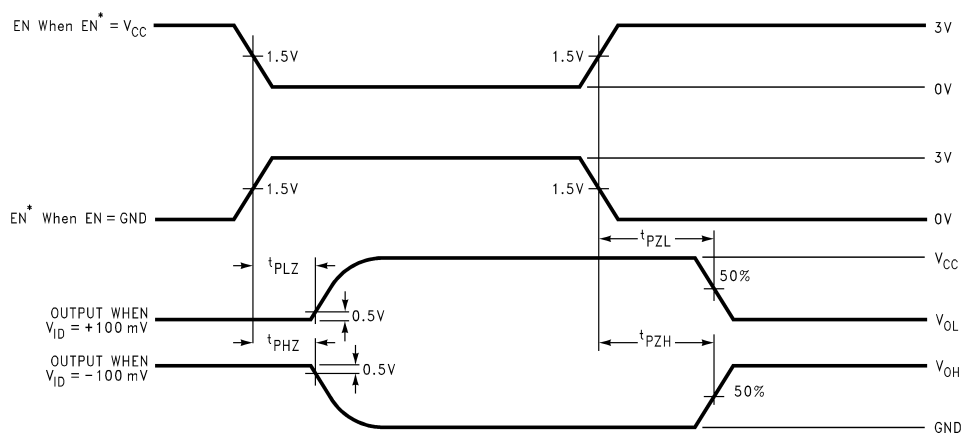

Figure 5. Receiver TRI-STATE Delay Waveforms

Typical Application

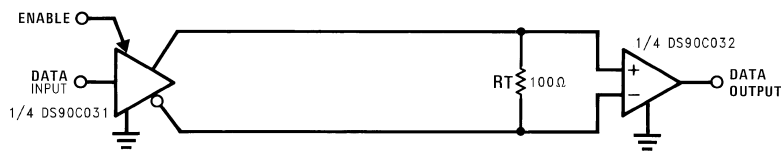

Figure 6. Point-to-Point Application

APPLICATIONS INFORMATION

LVDS drivers and receivers are intended to be primarily used in an uncomplicated point-to-point configuration as is shown in [Figure 6](#). This configuration provides a clean signaling environment for the quick edge rates of the drivers. The receiver is connected to the driver through a balanced media which may be a standard twisted pair cable, a parallel pair cable, or simply PCB traces. Typically the characteristic impedance of the media is in the range of 100Ω. A termination resistor of 100Ω should be selected to match the media, and is located as close to the receiver input pins as possible. The termination resistor converts the current sourced by the driver into a voltage that is detected by the receiver. Other configurations are possible such as a multi-receiver configuration, but the effects of a mid-stream connector(s), cable stub(s), and other impedance discontinuities as well as ground shifting, noise margin limits, and total termination loading must be taken into account.

The DS90C032B differential line receiver is capable of detecting signals as low as 100 mV, over a ±1V common-mode range centered around +1.2V. This is related to the driver offset voltage which is typically +1.2V. The driven signal is centered around this voltage and may shift ±1V around this center point. The ±1V shifting may be the result of a ground potential difference between the driver's ground reference and the receiver's ground reference, the common-mode effects of coupled noise, or a combination of the two. Both receiver input pins should honor their specified operating input voltage range of 0V to +2.4V (measured from each pin to ground), exceeding these limits may turn on the ESD protection circuitry which will clamp the bus voltages.

RECEIVER FAILSAFE

The LVDS receiver is a high gain, high speed device that amplifies a small differential signal (20mV) to CMOS logic levels. Due to the high gain and tight threshold of the receiver, care should be taken to prevent noise from appearing as a valid signal.

The receiver's internal failsafe circuitry is designed to source/sink a small amount of current, providing failsafe protection (a stable known state of HIGH output voltage) for floating and terminated (100Ω) receiver inputs in low noise environment (differential noise < 10mV).

1. Open Input Pins.

The DS90C032B is a quad receiver device, and if an application requires only 1, 2, or 3 receivers, the unused channel(s) inputs should be left OPEN. Do not tie unused receiver inputs to ground or any other voltages. The input is biased by internal high value pull up and pull down resistors to set the output to a HIGH state. This internal circuitry will ensure a HIGH, stable output state for open inputs.

2. Terminated Input. The DS90C032B requires external failsafe biasing for terminated input failsafe.

Terminated input failsafe is the case of a receiver that has a 100Ω termination across its inputs and the driver is in the following situations. Unplugged from the bus, or the driver output is in TRI-STATE or in power-off condition. The use of external biasing resistors provide a small bias to set the differential input voltage while the line is un-driven, and therefore the receiver output will be in HIGH state. If the driver is removed from the bus but the cable is still present and floating, the unplugged cable can become a floating antenna that can pick up noise. The LVDS receiver is designed to detect very small amplitude and width signals and recover them to standard logic levels. Thus, if the cable picks up more than 10mV of differential noise, the receiver may respond. To insure that any noise is seen as common-mode and not differential, a balanced interconnect and twisted pair cables is recommended, as they help to ensure that noise is coupled common to both lines and rejected by the receivers.

3. Operation in environment with greater than 10mV differential noise.

TI recommends external failsafe biasing on its LVDS receivers for a number of system level and signal quality reasons. First, only an application that requires failsafe biasing needs to employ it. Second, the amount of failsafe biasing is now an application design parameter and can be custom tailored for the specific application. In applications in low noise environments, they may choose to use a very small bias if any. For applications with less balanced interconnects and/or in high noise environments they may choose to boost failsafe further. TI's "LVDS Owner's Manual provides detailed calculations for selecting the proper failsafe biasing resistors. Third, the common-mode voltage is biased by the resistors during the un-driven state. This is selected to be close to the nominal driver offset voltage (V_{OS}). Thus when switching between driven and un-driven states, the common-mode modulation on the bus is held to a minimum.

For additional Failsafe Biasing information, please refer to Application Note [AN-1194](#) for more detail.

The footprint of the DS90C032B is the same as the industry standard 26LS32 Quad Differential (RS-422) Receiver.

For additional LVDS application information, please refer to TI's LVDS Owner's Manual available through TI's website <http://www.ti.com/lvds>

Pin Descriptions

Pin No.	Name	Description
2, 6, 10, 14	R _{IN+}	Non-inverting receiver input pin
1, 7, 9, 15	R _{IN-}	Inverting receiver input pin
3, 5, 11, 13	R _{OUT}	Receiver output pin
4	EN	Active high enable pin, OR-ed with EN*
12	EN*	Active low enable pin, OR-ed with EN
16	V _{CC}	Power supply pin, +5V ± 10%
8	GND	Ground pin

Typical Performance Characteristics

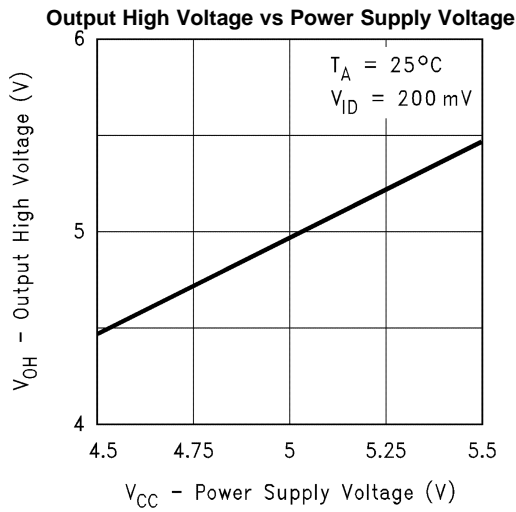

Figure 7.

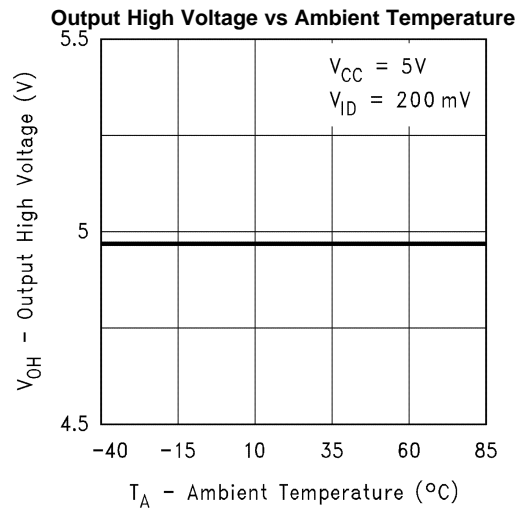

Figure 8.

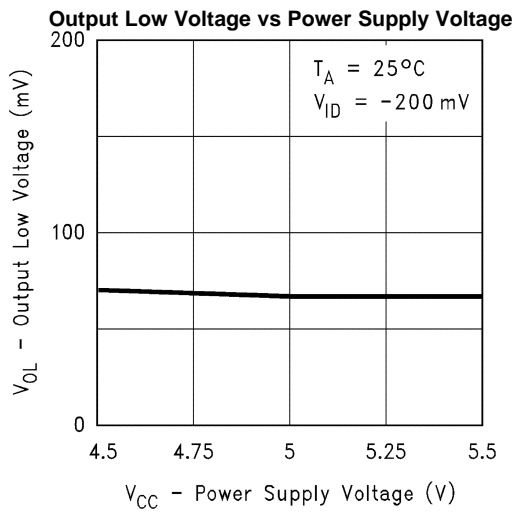

Figure 9.

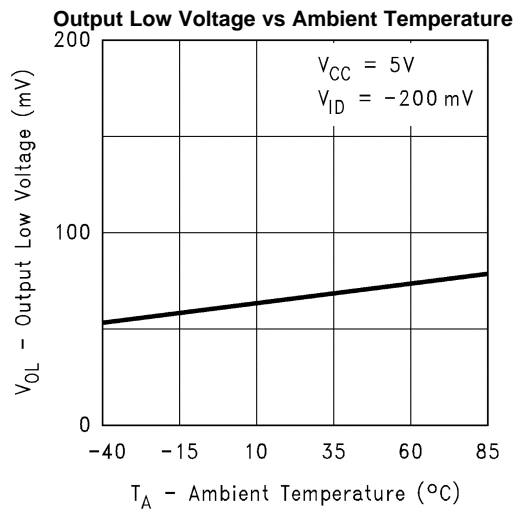

Figure 10.

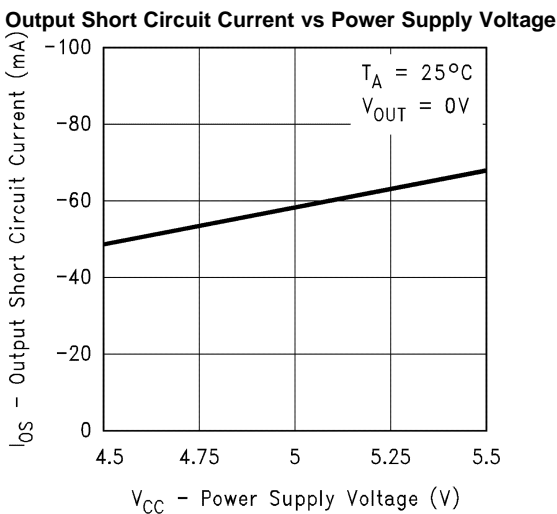

Figure 11.

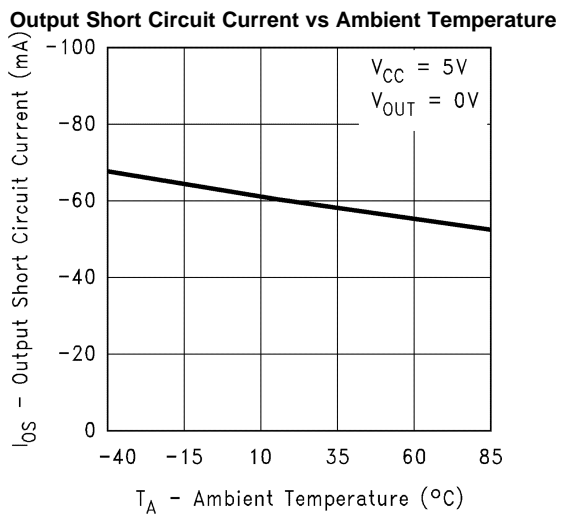

Figure 12.

Typical Performance Characteristics (continued)

Differential Propagation Delay vs Power Supply Voltage

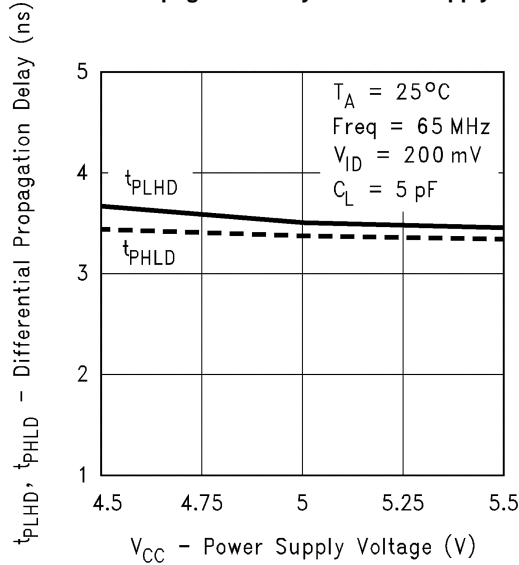

Figure 13.

Differential Propagation Delay vs Ambient Temperature

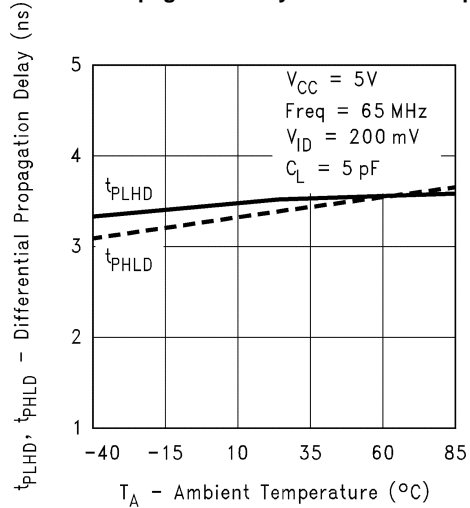

Figure 14.

Differential Skew vs Power Supply Voltage

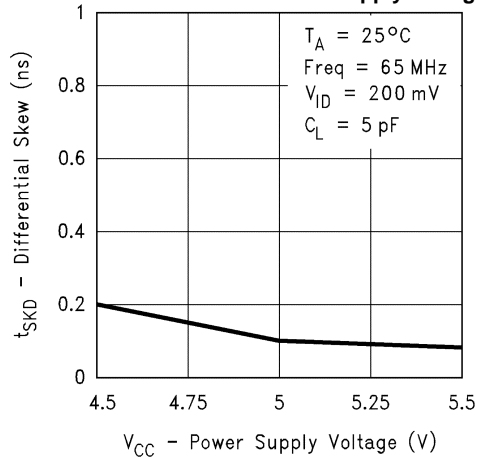

Figure 15.

Differential Skew vs Ambient Temperature

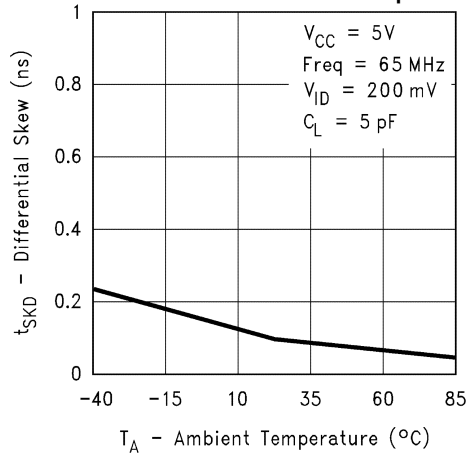

Figure 16.

Transition Time vs Power Supply Voltage

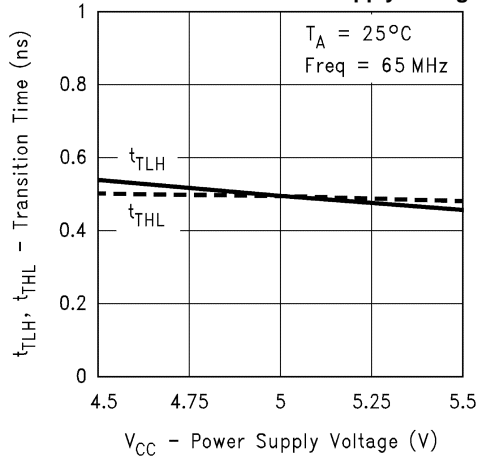

Figure 17.

Transition Time vs Ambient Temperature

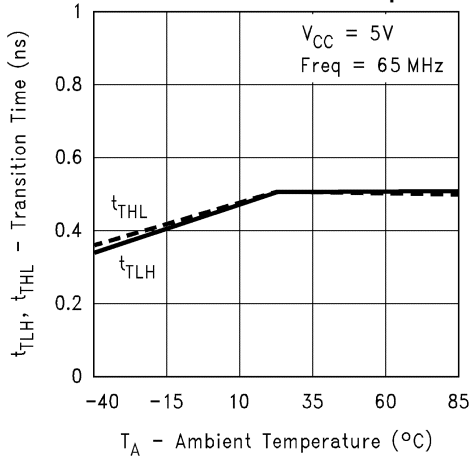

Figure 18.

REVISION HISTORY

Changes from Revision B (April 2013) to Revision C	Page
• Changed layout of National Data Sheet to TI format	9

PACKAGING INFORMATION

Orderable Device	Status (1)	Package Type	Package Drawing	Pins	Package Qty	Eco Plan (2)	Lead finish/ Ball material (6)	MSL Peak Temp (3)	Op Temp (°C)	Device Marking (4/5)	Samples
DS90C032BTM	NRND	SOIC	D	16	48	Non-RoHS & Green	Call TI	Call TI	-40 to 85	DS90C032BTM	
DS90C032BTM/NOPB	ACTIVE	SOIC	D	16	48	RoHS & Green	Call TI SN	Level-1-260C-UNLIM	-40 to 85	DS90C032BTM	Samples
DS90C032BTMX	NRND	SOIC	D	16	2500	Non-RoHS & Green	Call TI	Call TI	-40 to 85	DS90C032BTM	
DS90C032BTMX/NOPB	ACTIVE	SOIC	D	16	2500	RoHS & Green	Call TI SN	Level-1-260C-UNLIM	-40 to 85	DS90C032BTM	Samples

(1) The marketing status values are defined as follows:

ACTIVE: Product device recommended for new designs.

LIFEBUY: TI has announced that the device will be discontinued, and a lifetime-buy period is in effect.

NRND: Not recommended for new designs. Device is in production to support existing customers, but TI does not recommend using this part in a new design.

PREVIEW: Device has been announced but is not in production. Samples may or may not be available.

OBSELETE: TI has discontinued the production of the device.

(2) **RoHS:** TI defines "RoHS" to mean semiconductor products that are compliant with the current EU RoHS requirements for all 10 RoHS substances, including the requirement that RoHS substance do not exceed 0.1% by weight in homogeneous materials. Where designed to be soldered at high temperatures, "RoHS" products are suitable for use in specified lead-free processes. TI may reference these types of products as "Pb-Free".

RoHS Exempt: TI defines "RoHS Exempt" to mean products that contain lead but are compliant with EU RoHS pursuant to a specific EU RoHS exemption.

Green: TI defines "Green" to mean the content of Chlorine (Cl) and Bromine (Br) based flame retardants meet JS709B low halogen requirements of <=1000ppm threshold. Antimony trioxide based flame retardants must also meet the <=1000ppm threshold requirement.

(3) MSL, Peak Temp. - The Moisture Sensitivity Level rating according to the JEDEC industry standard classifications, and peak solder temperature.

(4) There may be additional marking, which relates to the logo, the lot trace code information, or the environmental category on the device.

(5) Multiple Device Markings will be inside parentheses. Only one Device Marking contained in parentheses and separated by a "~" will appear on a device. If a line is indented then it is a continuation of the previous line and the two combined represent the entire Device Marking for that device.

(6) Lead finish/Ball material - Orderable Devices may have multiple material finish options. Finish options are separated by a vertical ruled line. Lead finish/Ball material values may wrap to two lines if the finish value exceeds the maximum column width.

Important Information and Disclaimer:The information provided on this page represents TI's knowledge and belief as of the date that it is provided. TI bases its knowledge and belief on information provided by third parties, and makes no representation or warranty as to the accuracy of such information. Efforts are underway to better integrate information from third parties. TI has taken and

continues to take reasonable steps to provide representative and accurate information but may not have conducted destructive testing or chemical analysis on incoming materials and chemicals. TI and TI suppliers consider certain information to be proprietary, and thus CAS numbers and other limited information may not be available for release.

In no event shall TI's liability arising out of such information exceed the total purchase price of the TI part(s) at issue in this document sold by TI to Customer on an annual basis.

TAPE AND REEL INFORMATION



QUADRANT ASSIGNMENTS FOR PIN 1 ORIENTATION IN TAPE



*All dimensions are nominal

Device	Package Type	Package Drawing	Pins	SPQ	Reel Diameter (mm)	Reel Width W1 (mm)	A0 (mm)	B0 (mm)	K0 (mm)	P1 (mm)	W (mm)	Pin1 Quadrant
DS90C032BTMX	SOIC	D	16	2500	330.0	16.4	6.5	10.3	2.3	8.0	16.0	Q1
DS90C032BTMX/NOPB	SOIC	D	16	2500	330.0	16.4	6.5	10.3	2.3	8.0	16.0	Q1

TAPE AND REEL BOX DIMENSIONS

*All dimensions are nominal

Device	Package Type	Package Drawing	Pins	SPQ	Length (mm)	Width (mm)	Height (mm)
DS90C032BTMX	SOIC	D	16	2500	367.0	367.0	35.0
DS90C032BTMX/NOPB	SOIC	D	16	2500	367.0	367.0	35.0

D (R-PDSO-G16)

PLASTIC SMALL OUTLINE



- NOTES:
- A. All linear dimensions are in inches (millimeters).
 - B. This drawing is subject to change without notice.
 - C. Body length does not include mold flash, protrusions, or gate burrs. Mold flash, protrusions, or gate burrs shall not exceed 0.006 (0,15) each side.
 - D. Body width does not include interlead flash. Interlead flash shall not exceed 0.017 (0,43) each side.
 - E. Reference JEDEC MS-012 variation AC.

IMPORTANT NOTICE AND DISCLAIMER

TI PROVIDES TECHNICAL AND RELIABILITY DATA (INCLUDING DATASHEETS), DESIGN RESOURCES (INCLUDING REFERENCE DESIGNS), APPLICATION OR OTHER DESIGN ADVICE, WEB TOOLS, SAFETY INFORMATION, AND OTHER RESOURCES "AS IS" AND WITH ALL FAULTS, AND DISCLAIMS ALL WARRANTIES, EXPRESS AND IMPLIED, INCLUDING WITHOUT LIMITATION ANY IMPLIED WARRANTIES OF MERCHANTABILITY, FITNESS FOR A PARTICULAR PURPOSE OR NON-INFRINGEMENT OF THIRD PARTY INTELLECTUAL PROPERTY RIGHTS.

These resources are intended for skilled developers designing with TI products. You are solely responsible for (1) selecting the appropriate TI products for your application, (2) designing, validating and testing your application, and (3) ensuring your application meets applicable standards, and any other safety, security, or other requirements. These resources are subject to change without notice. TI grants you permission to use these resources only for development of an application that uses the TI products described in the resource. Other reproduction and display of these resources is prohibited. No license is granted to any other TI intellectual property right or to any third party intellectual property right. TI disclaims responsibility for, and you will fully indemnify TI and its representatives against, any claims, damages, costs, losses, and liabilities arising out of your use of these resources.

TI's products are provided subject to TI's Terms of Sale (<https://www.ti.com/legal/termsofsale.html>) or other applicable terms available either on [ti.com](https://www.ti.com) or provided in conjunction with such TI products. TI's provision of these resources does not expand or otherwise alter TI's applicable warranties or warranty disclaimers for TI products.

Mailing Address: Texas Instruments, Post Office Box 655303, Dallas, Texas 75265
Copyright © 2021, Texas Instruments Incorporated