



US2A THRU US2M

Reverse Voltage - 50 to 1000 Volts Forward Current - 2.0 Ampere

SURFACE MOUNT ULTRA FAST RECTIFIER

Features

- ◆ The plastic package carries Underwriters Laboratory Flammability Classification 94V-0
- ◆ For surface mounted applications
- ◆ Ultra fast switching for high efficiency
- ◆ Low reverse leakage
- ◆ Built-in strain relief, ideal for automated placement
- ◆ High forward surge current capability
- ◆ High temperature soldering guaranteed
250 °C/10 seconds at terminals

DO-214AC/SMA

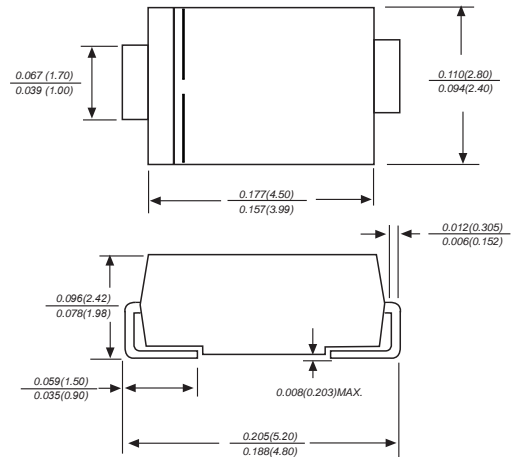

Dimensions in inches and (millimeters)

Mechanical Data

- Case** : JEDEC DO-214AC/SMA Molded plastic body
Terminals : Solder plated, solderable per MIL-STD-750, Method 2026
Polarity : Polarity symbol marking on body
Mounting Position : Any
Weight : 0.002 ounce, 0.7 grams

Maximum Ratings And Electrical Characteristics

Ratings at 25°C ambient temperature unless otherwise specified.

Single phase half-wave 60Hz, resistive or inductive load, for capacitive load current derate by 20%.

Parameter	SYMBOLS	MDD US2A	MDD US2B	MDD US2D	MDD US2G	MDD US2J	MDD US2K	MDD US2M	UNITS
Marking Code									
Maximum repetitive peak reverse voltage	V_{RRM}	50	100	200	400	600	800	1000	V
Maximum RMS voltage	V_{RMS}	35	70	140	280	420	560	700	V
Maximum DC blocking voltage	V_{DC}	50	100	200	400	600	800	1000	V
Maximum average forward rectified current at $T_L=55^\circ C$	$I_{(AV)}$	2.0							A
Peak forward surge current 8.3ms single half sine-wave superimposed on rated load (JEDEC Method)	I_{FSM}	50							A
Maximum instantaneous forward voltage at 2.0A	V_F	1.0		1.40		1.70		V	
Maximum DC reverse current $T_A=25^\circ C$ at rated DC blocking voltage $T_A=125^\circ C$	I_R	5 350							μA
Maximum reverse recovery time (NOTE 1)	t_{rr}	50				75			ns
Typical junction capacitance (NOTE 2)	C_J	28.0							pF
Typical thermal resistance (NOTE 3)	$R_{\theta JA}$	20.0							$^\circ C/W$
Operating junction and storage temperature range	T_J, T_{STG}	-55 to +150							$^\circ C$

- Note:** 1. Reverse recovery condition $I_F=0.5A, I_R=1.0A, I_{rr}=0.25A$.
 2. P.C.B. mounted with 2.0x2.0" (5.0x5.0cm) copper pad areas.
 3. Measured at 1MHz and applied reverse voltage of 4.0V D.C.



US2A THRU US2M

Reverse Voltage - 50 to 1000 Volts Forward Current - 2.0 Amperes

Ratings And Characteristic Curves

AVERAGE FORWARD RECTIFIED CURRENT, AMPERES

FIG. 1- FORWARD CURRENT DERATING CURVE

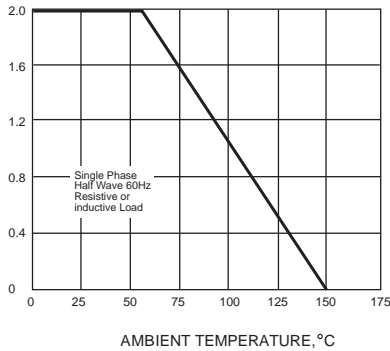

PEAK FORWARD SURGE CURRENT, AMPERES

FIG. 2-MAXIMUM NON-REPETITIVE PEAK FORWARD SURGE CURRENT

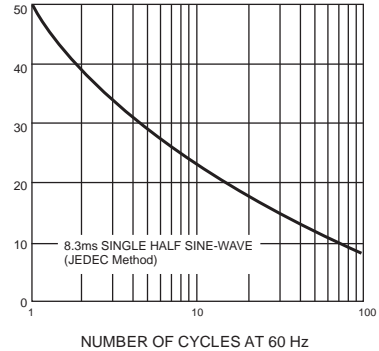

INSTANTANEOUS FORWARD CURRENT, AMPERES

FIG. 3-TYPICAL INSTANTANEOUS FORWARD CHARACTERISTICS

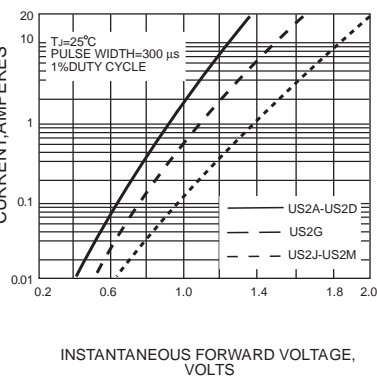

INSTANTANEOUS REVERSE CURRENT, MICROAMPERES

FIG. 4-TYPICAL REVERSE CHARACTERISTICS

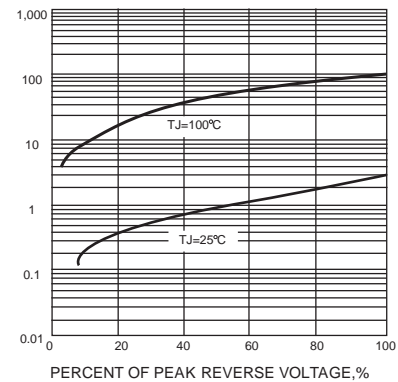

JUNCTION CAPACITANCE, pF

FIG. 5-TYPICAL JUNCTION CAPACITANCE

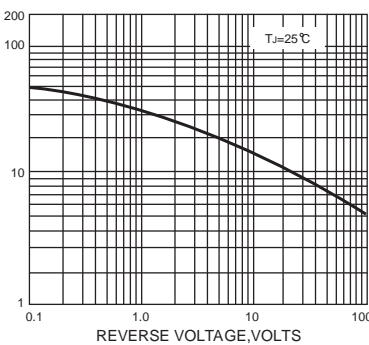

TRANSIENT THERMAL IMPEDANCE, °C/W

FIG. 6-TYPICAL TRANSIENT THERMAL IMPEDANCE

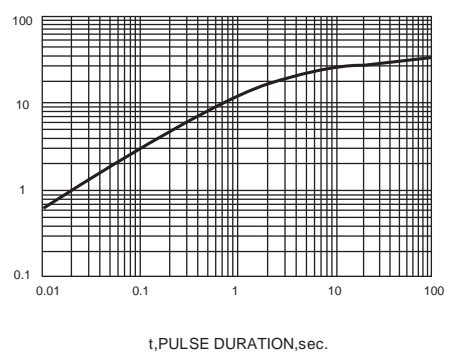

The curve above is for reference only.



US2A THRU US2M

Reverse Voltage - 50 to 1000 Volts Forward Current - 2.0 Ampere

Packing information

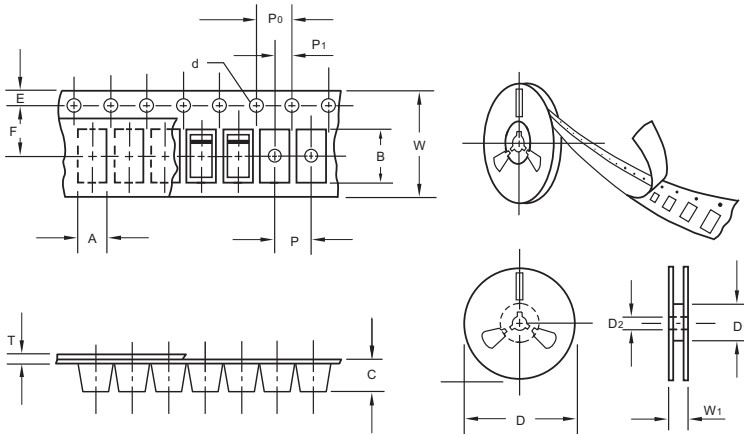

unit:mm

Item	Symbol	Tolerance	SMA
Carrier width	A	0.1	2.80
Carrier length	B	0.1	5.33
Carrier depth	C	0.1	2.36
Sprocket hole	d	0.05	1.50
13" Reel outside diameter	D	2.0	330.00
13" Reel inner diameter	D ₁	min	50.00
7" Reel outside diameter	D	2.0	178.00
7" Reel inner diameter	D ₁	min	62.00
Feed hole diameter	D ₂	0.5	13.00
Sprocket hole position	E	0.1	1.75
Punch hole position	F	0.1	5.50
Punch hole pitch	P	0.1	4.00
Sprocket hole pitch	P ₀	0.1	4.00
Embossment center	P ₁	0.1	2.00
Overall tape thickness	T	0.1	0.28
Tape width	W	0.3	12.00
Reel width	W ₁	1.0	18.00

Note: Devices are packed in accordance with EIA standard RS-481-A and specifications listed above.

Reel packing

PACKAGE	REEL SIZE	REEL (pcs)	COMPONENT SPACING (m/m)	BOX (pcs)	INNER BOX (m/m)	REEL DIA, (m/m)	CARTON SIZE (m/m)	CARTON (pcs)	APPROX. GROSS WEIGHT (kg)
SMA	7"	2,000	4.0	4,000	183*155*183	178	382*356*392	80,000	16.0
SMA	11"	5,000	4.0	10,000	290*290*38	330	310*310*360	80,000	11.0
SMA	13"	7,500	4.0	15,000	335*335*38	330	350*330*360	120,000	14.5

Suggested Pad Layout



Symbol	Unit (mm)	Unit (inch)
A	1.68	0.066
B	1.52	0.060
C	3.90	0.154
D	2.41	0.095
E	5.45	0.215