

WIDE BAND FM IF DEMODULATOR

GENERAL DESCRIPTION

The **NJM14570** is a wide band IF IC with a maximum IF input frequency of 15 MHz. It includes an IF Amplifier, Quadrature Detector and RSSI.

PACKAGE OUTLINE

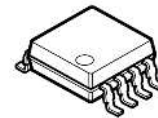

NJM14570RB1

MAIN APPLICATIONS

- RF ID
- Radar detector
- Wireless Infrared Communication System
- Voice Transmission System
- A few MHz band Signal Detector

FEATURES

- Wide Range Operating Voltage 1.8V to 9V (recommended supply voltage)
- Low Operating Current 2.9mA (Typ., No Signal)
- Wide Range IF Input Frequency 10.7MHz (Standard) up to 15MHz (Reference)
- Wide Band FM Detector Range DC to 1MHz (Reference)
- High FM Detection Sensitivity - 87dBm (12dB SINAD, typ.)
- Package Outline MSOP8 (TVSP) *
*JEDEC MO-187-DA/ thin type

BLOCK DIAGRAM

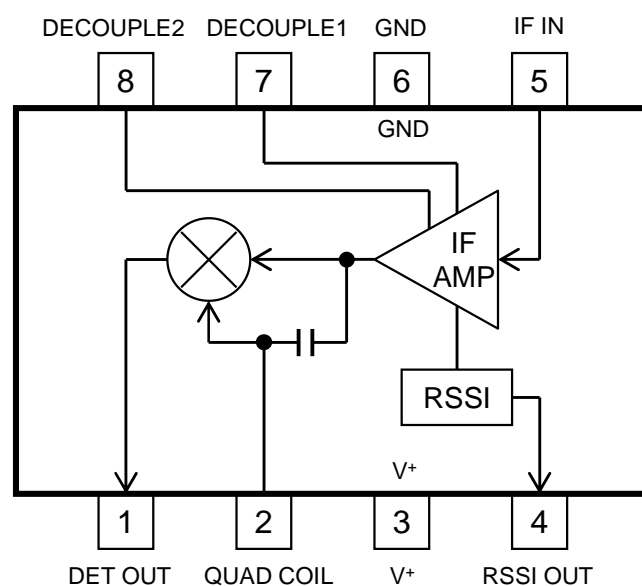

■ ABSOLUTE MAXIMUM RATINGS

(Ta=25°C)

PARAMETER	SYMBOL	RATINGS	UNIT
Supply Voltage	V ⁺	10	V
Power Dissipation	P _D	410	mW
Operating Temperature	T _{opr}	- 40 to + 85	°C
Storage Temperature	T _{stg}	- 50 to + 125	°C

■ RECOMMENDED OPERATIONAL CONDITION

(Ta=25°C)

PARAMETER	SYMBOL	TEST CONDITIONS	MIN.	TYP.	MAX.	UNIT
Supply Voltage	V ⁺		1.8	3.0	9.0	V

■ ELECTRICAL CHARACTERISTICS

(Ta = 25°C, V⁺ = 3V, IF IN = 10.7MHz / - 30dBm, fdev = ± 50kHz, fmod = 1kHz, unless otherwise noted)

PARAMETER	SYMBOL	TEST CONDITIONS	MIN.	TYP.	MAX.	UNIT
Current Consumption	I _{ccq}	No Signal	-	2.9	4.1	mA

DETECTION

Output Voltage	V _{OUT}		60	100	160	mVrms
Total Harmonics Distortion	THD		-	0.5	2.0	%
Signal to Noise Ratio	S/N		54	60	-	dB
12dB SINAD	SINAD		-	- 87	- 81	dBm
Limiter Input Resistance	R _{LIM}		-	330	-	Ω

RSSI

RSSI Output Voltage	V _{RSSI1}	No Signal	0.00	0.05	0.30	V
	V _{RSSI2}	- 60 dBm, No Modulation	0.20	0.40	0.60	V
	V _{RSSI3}	- 30 dBm, No Modulation	0.80	1.05	1.30	V
	V _{RSSI4}	0 dBm, No Modulation	1.20	1.50	1.80	V

■ TEST CIRCUIT

This test circuit allows the measurement of all parameters described in "ELECTRICAL CHARACTERISTICS".

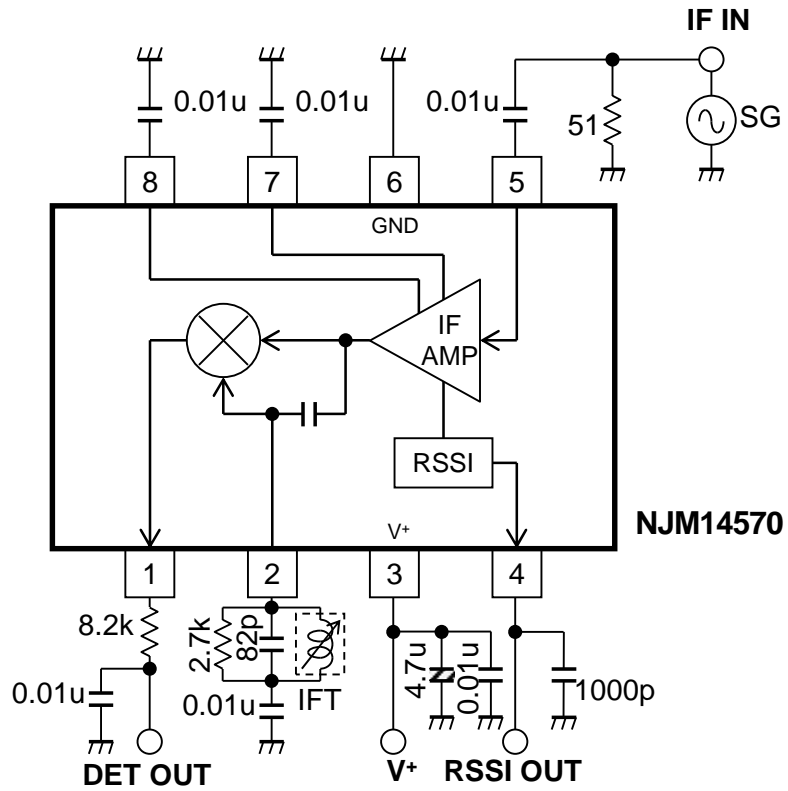

IFT:10.7MHz IF Transformer

EVALUATION BOARD

The evaluation board is useful for your design and to have more understanding of the usage and performance of this device. This circuit is the same as TEST CIRCUIT. Note that this board is not prepared to show the recommendation of pattern and parts layout.

Circuit Diagram

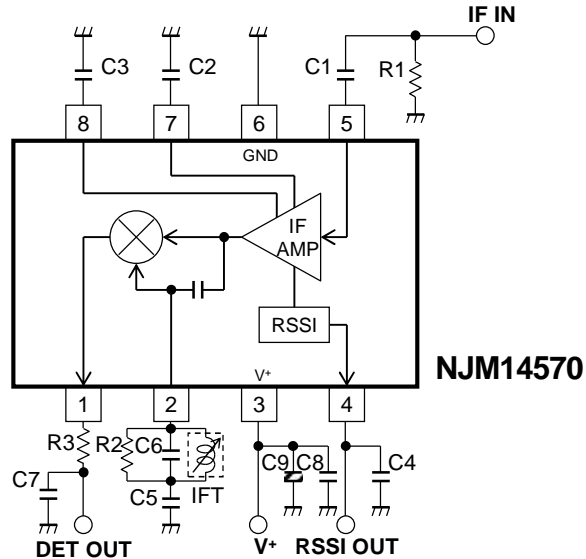

PRINTED CIRCUIT BOARD

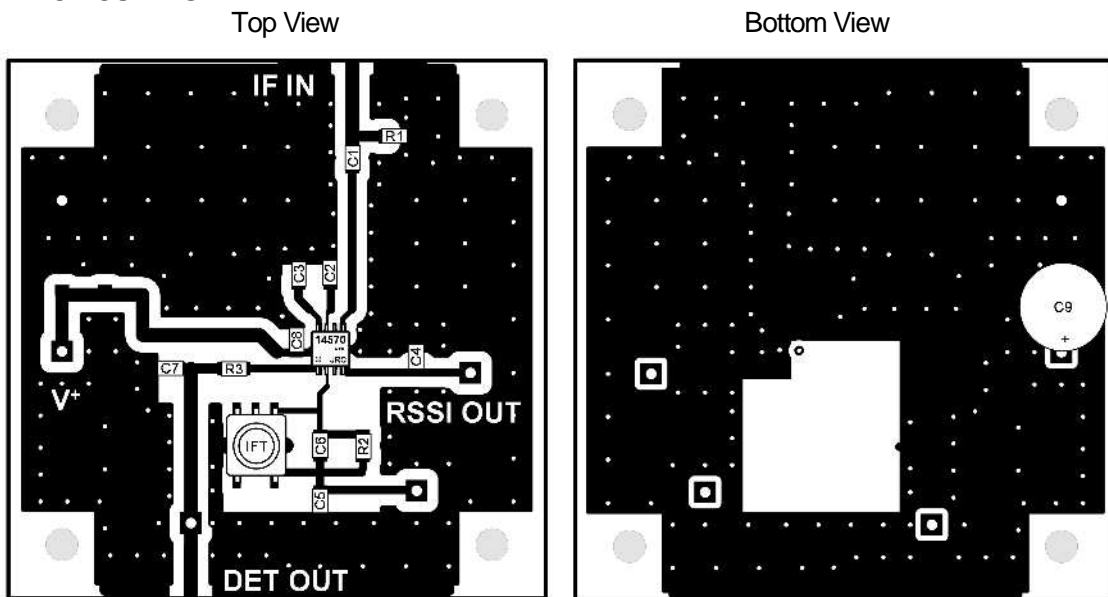

List of Component

Items	Designation	Value	Items	Designation	Value
Capacitor	C1	0.01uF	Resistor	R1	51Ω
Capacitor	C2	0.01uF			For testing purposes only
Capacitor	C3	0.01uF			
Capacitor	C4	1000pF	Resistor	R2	2.7kΩ
Capacitor	C5	0.01uF	Resistor	R3	8.2kΩ
Capacitor	C6	82pF	Transformer	IFT	10.7MHz IF Transformer
Capacitor	C7	0.01uF			
Capacitor	C8	0.01uF	IC	NJM14570	NJM14570RB1
Capacitor	C9	4.7uF			

■ **TERMINAL FUNCTION**

(Ta = 25°C, V+ = 3V, No signal)

Pin No.	SYMBOL	EQUIVALENT CIRCUIT	VOLTAGE	FUNCTION
1	DET OUT		1.5V	FM Detector Output
2	QUAD COIL		3.0V	FM Detector Input Connection for the phase shift circuit.
3 6	V+ GND		3.0V 0.0V	3pin:Supply Voltage 6pin:GND Terminal
4	RSSI OUT		--	Received Signal Strength Indicator Output Pin4 outputs DC level proportional to the log of pin5 input signal level.
5 7 8	IF IN DECOUPLE1 DECOUPLE2		2.6V	5pin: IF Amplifier Input 7,8pin: IF Decoupling An external decoupling capacitor is connected to enhance stability. The bandwidth of IF Amplifier can be adjusted. Large capacity: wide band Small capacity: narrow band

TYPICAL CHARACTERISTICS

Ta = 25°C, V+ = 3V, IF IN = 10.7MHz / -30dBm, fdev = ±50kHz, fmod = 1kHz, unless otherwise noted

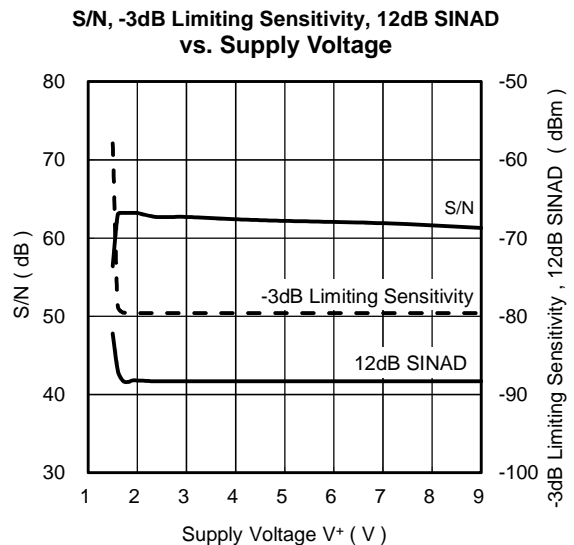
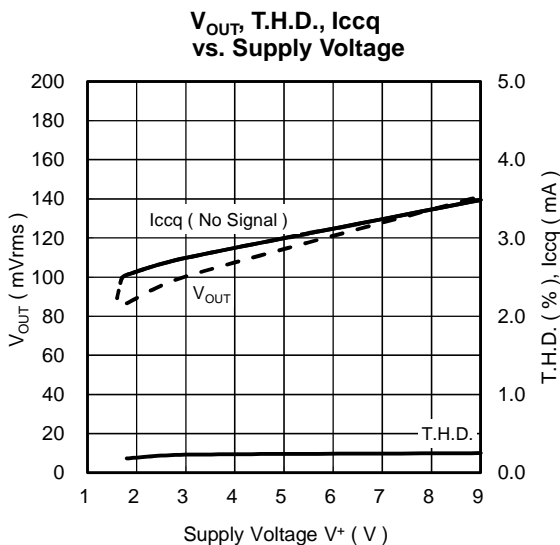
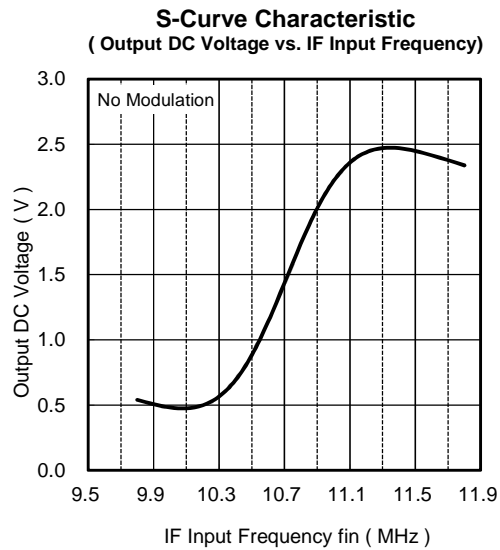
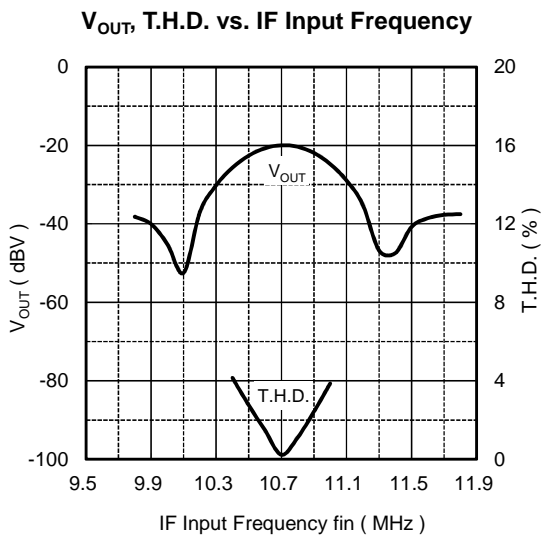
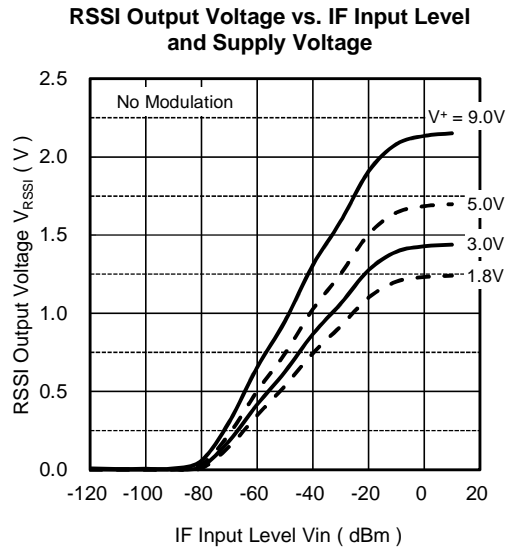
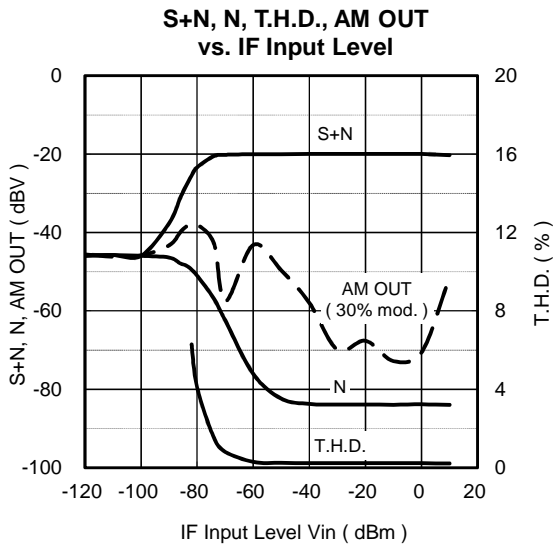

■ **Electrical characteristics by changing damping resistor R_D**

$T_a = 25^\circ\text{C}$, $V^+ = 3\text{V}$, IF IN = 10.7MHz / - 30dBm, $f_{\text{dev}} = \pm 50\text{kHz}$, $f_{\text{mod}} = 1\text{kHz}$, unless otherwise noted

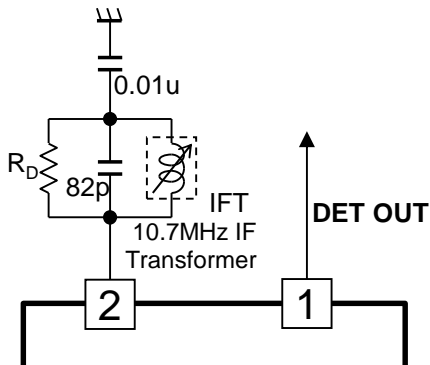

V_{OUT} , T.H.D. vs. R_D

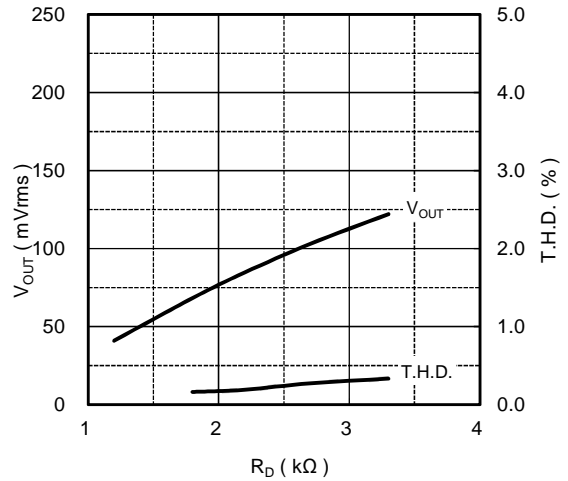

S-Curve Characteristic
(Output DC Voltage vs. IF Input Frequency and R_D)

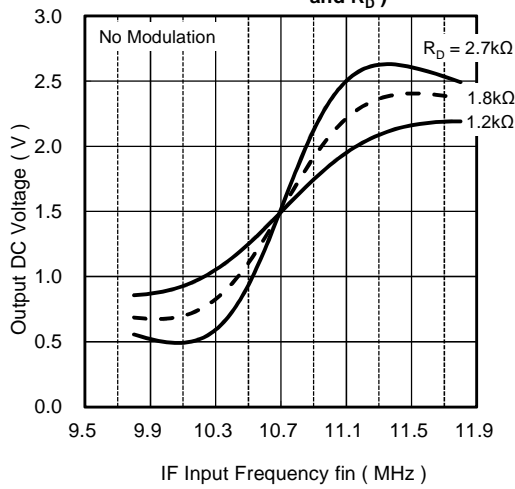

FM Demodulated Output Level vs. FM Modulation Frequency and R_D

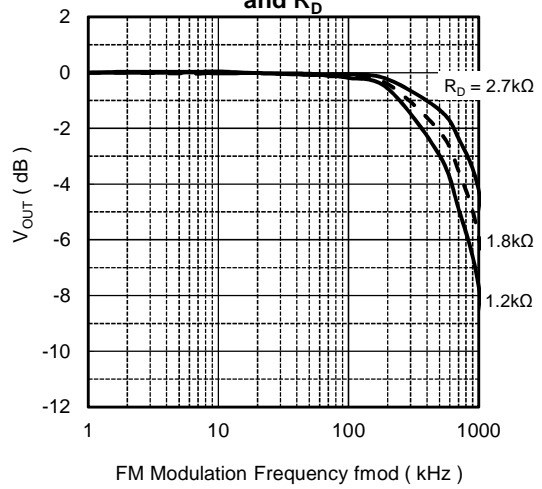

Ambient Temperature Characteristics

Ta = 25°C, V+ = 3V, IF IN = 10.7MHz / -30dBm, fdev = ±50kHz, fmod = 1kHz, unless otherwise noted

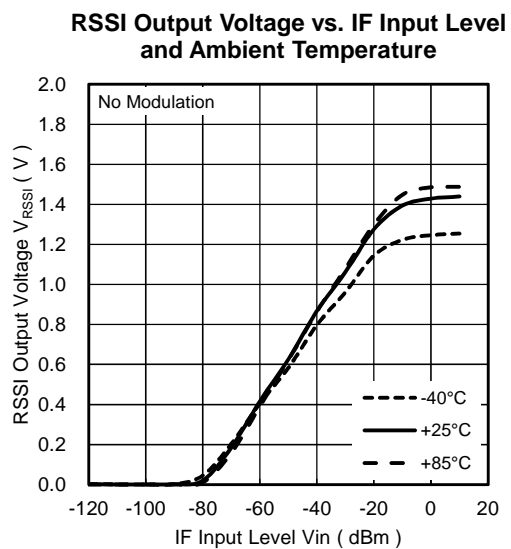
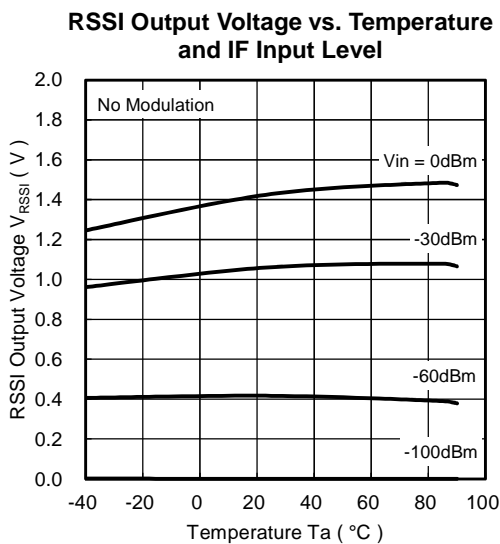
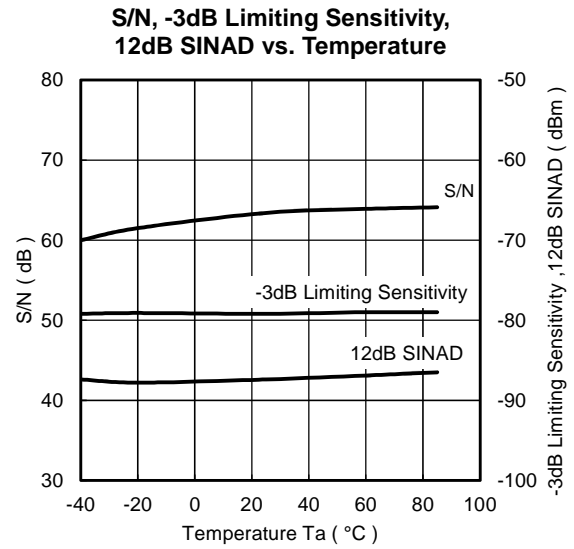
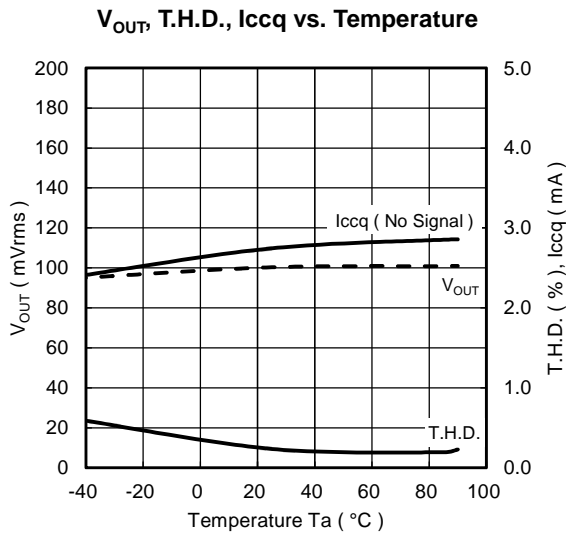

■ RSSI Output Transient Response (IF Input ON/ OFF)

Ta = 25°C, V+ = 3V, IF IN = 10.7MHz, No Modulation, unless otherwise noted

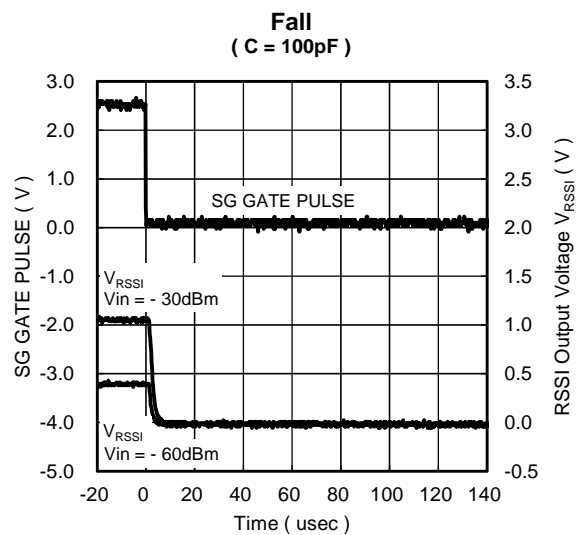
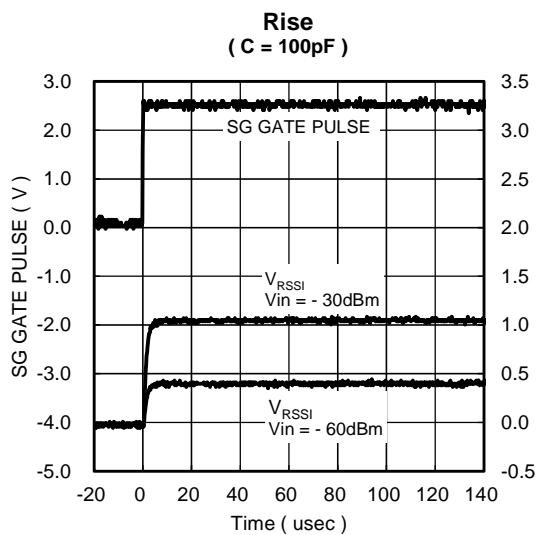
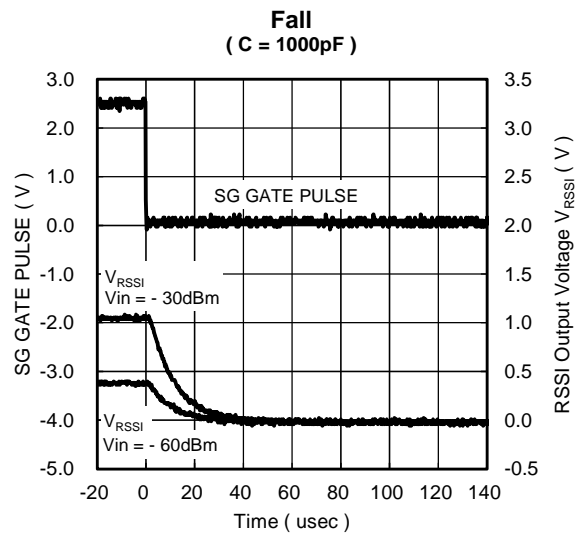
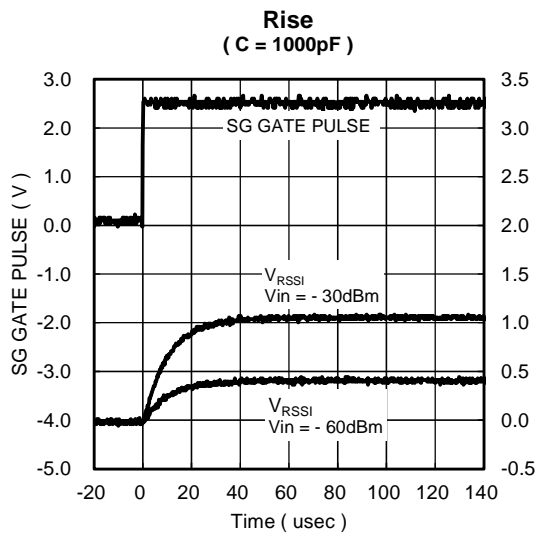
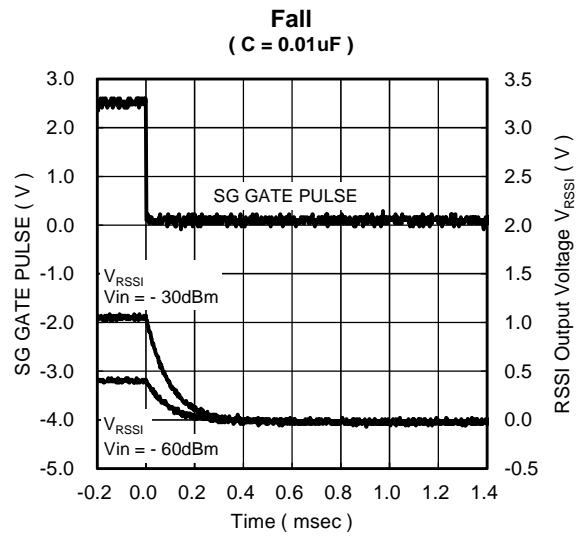
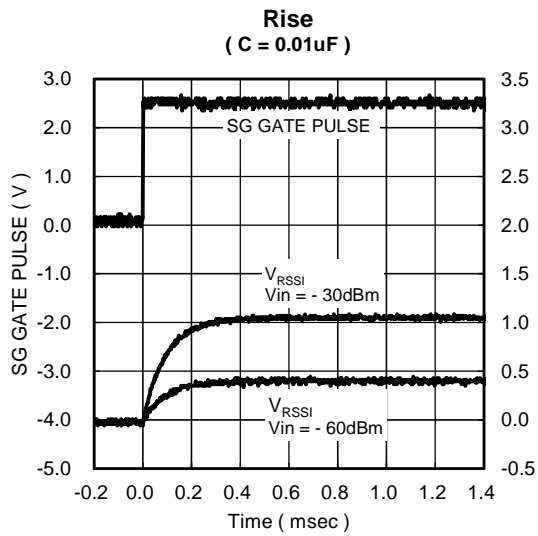
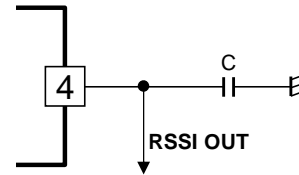

■ RSSI Output Transient Response (V^+ ON/ OFF)

$T_a = 25^\circ\text{C}$, $V^+ = 3\text{V}$, $f_{IN} = 10.7\text{MHz}$, No Modulation, unless otherwise noted

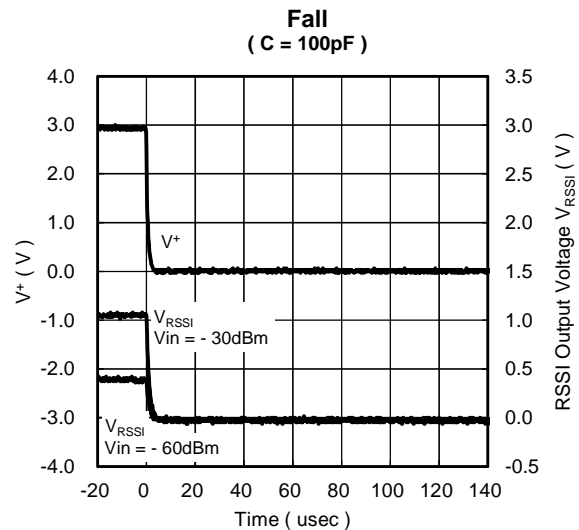
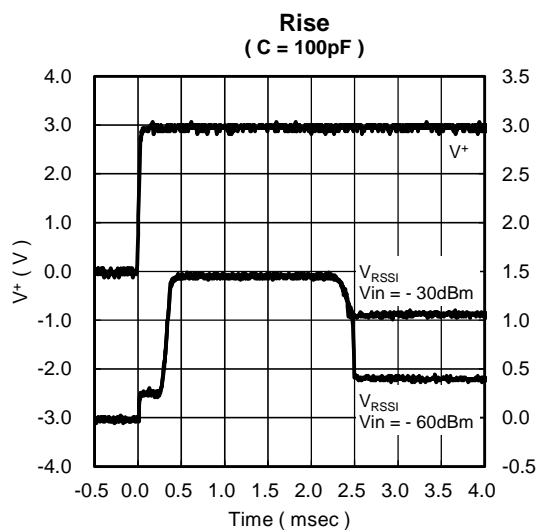
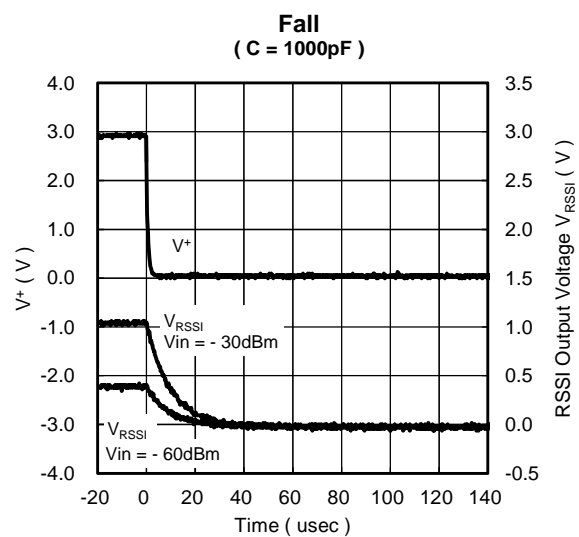
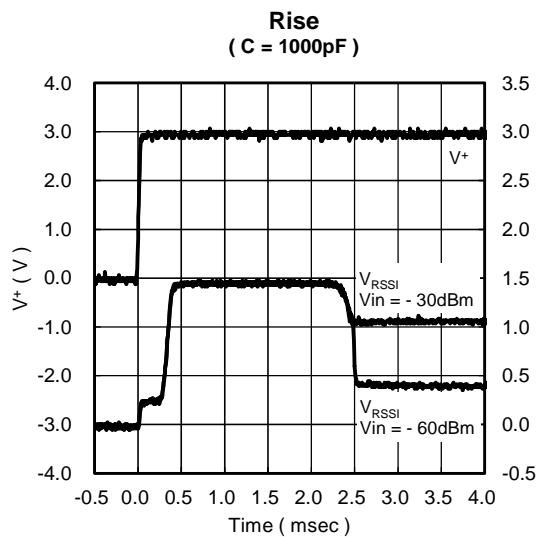
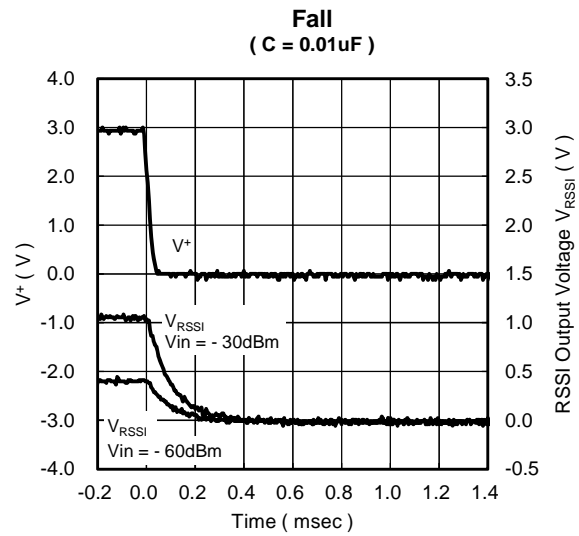
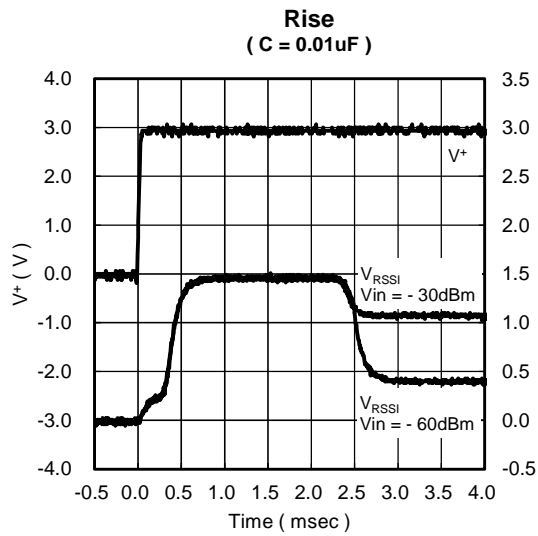
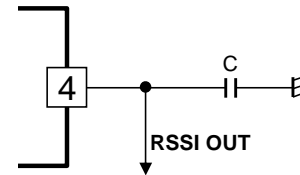

DETECTOR Output Transient Response

Ta = 25°C, V+ = 3V, IF IN = 10.7MHz / - 30dBm, fdev = ± 50kHz, fmod = 1kHz, unless otherwise noted

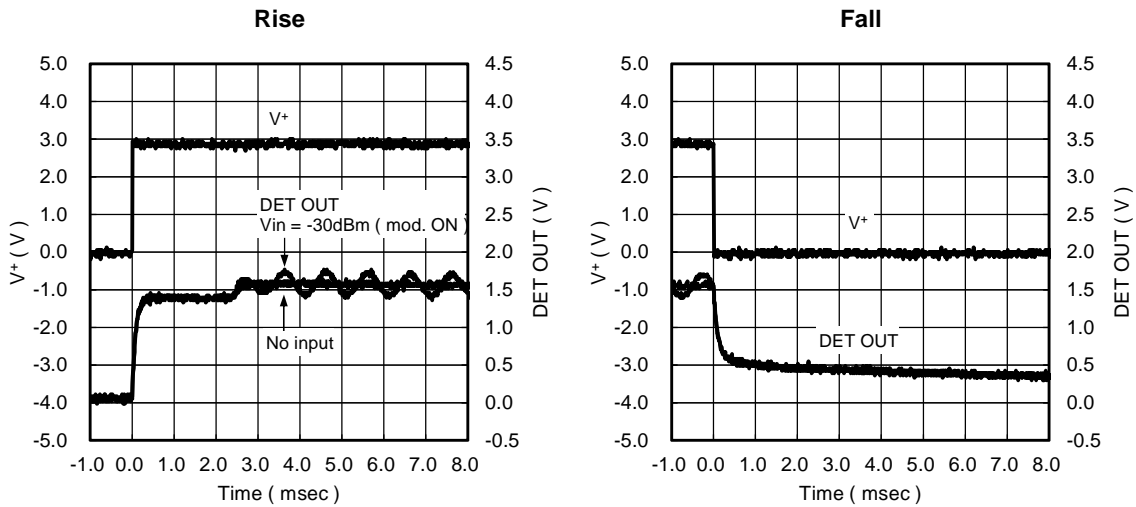

AM Demodulation output characteristics by using the RSSI output

Ta = 25°C, V+ = 3V, IF IN = 10.7MHz / - 50dBm, AM mod. = 80%, fmod = 10kHz, unless otherwise noted

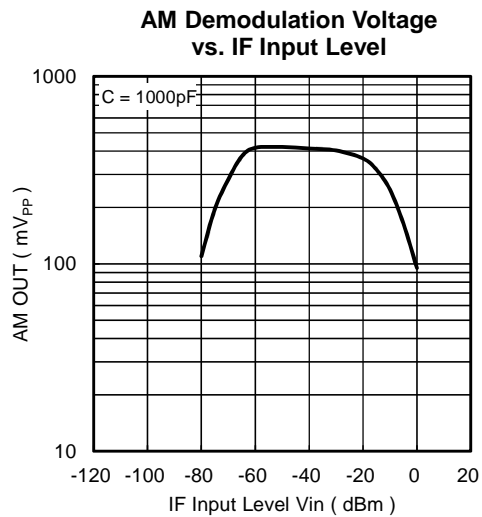
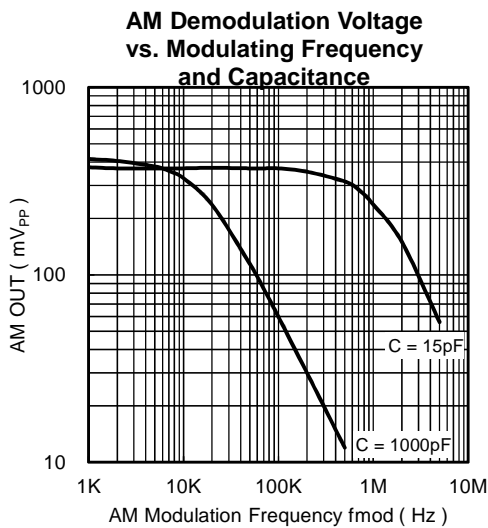
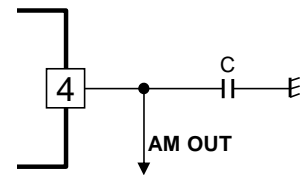

■ Electrical characteristics by using a Fixed Inductor

Ta = 25°C, V+ = 3V, IF IN = 10.7MHz / - 30dBm, fdev = ± 50kHz, fmod = 1kHz, unless otherwise noted

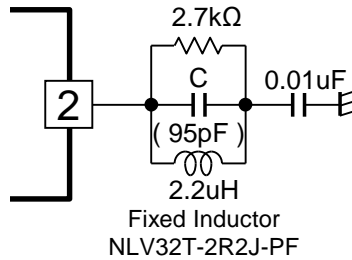

S-Curve Characteristics
(Output DC Voltage vs. IF Input Frequency and Capacitance)

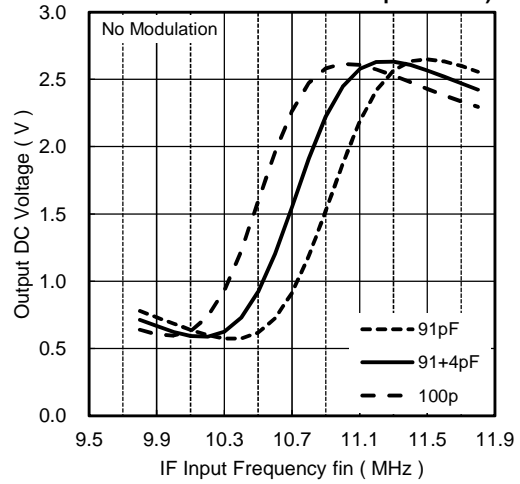

S+N, N, T.H.D., AM OUT vs. IF Input Level

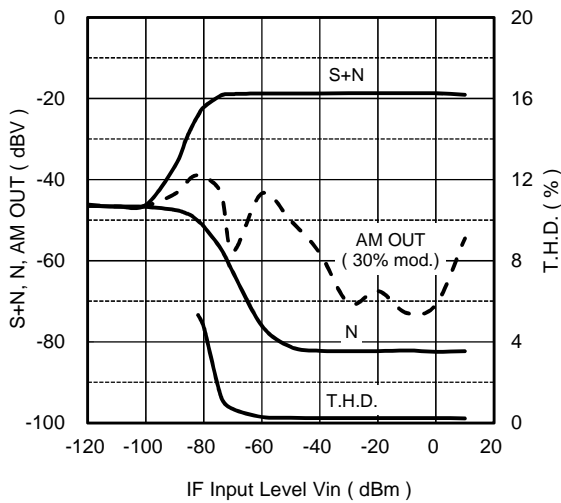

V_{OUT}, T.H.D. vs. IF Input Frequency

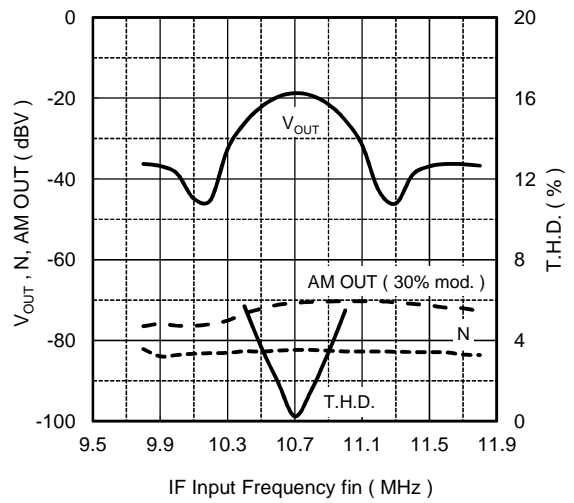

■ Electrical characteristics by using a Fixed Inductor

$V^+ = 3V$, IF IN = 10.7MHz / -30dBm, $f_{dev} = \pm 50kHz$, $f_{mod} = 1kHz$, unless otherwise noted

S-Curve Characteristics
(Output DC Voltage vs. IF Input Frequency and Ambient Temperature)

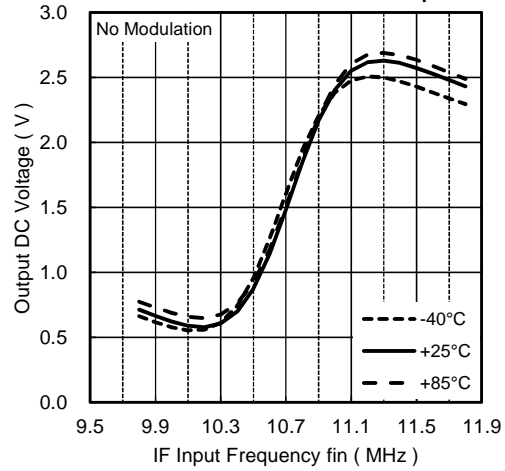

S-Curve Characteristics for wide band
(Output DC Voltage vs. IF Input Frequency and Ambient Temperature)

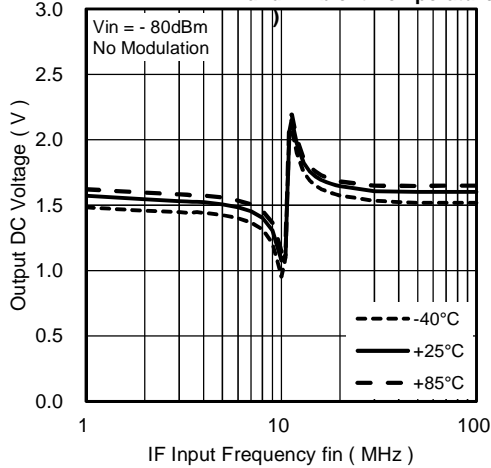

S-Curve Characteristics for wide band
(Output DC Voltage vs. IF Input Frequency and Ambient Temperature)

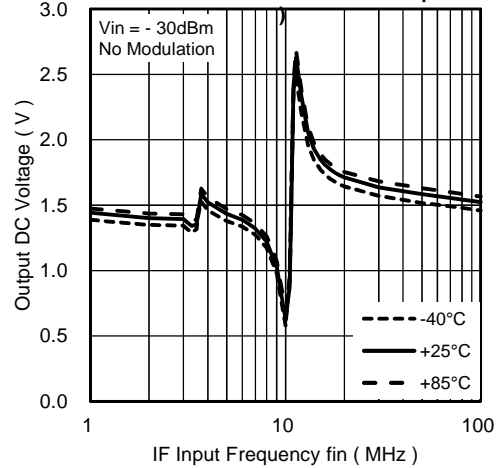

S+N, N, T.H.D., AM OUT vs. IF Input Level and Ambient Temperature

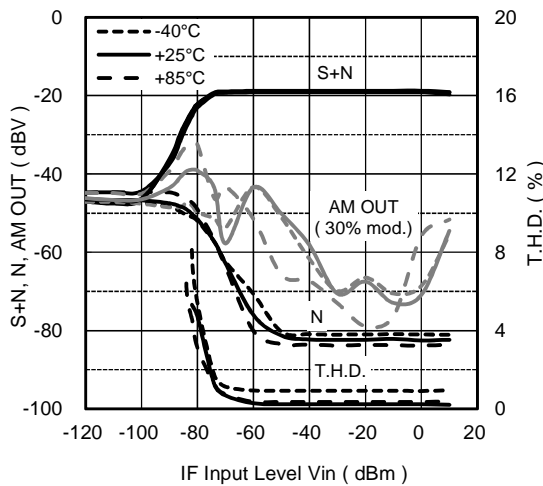

V_{OUT} , T.H.D. vs. IF Input Frequency and Ambient Temperature

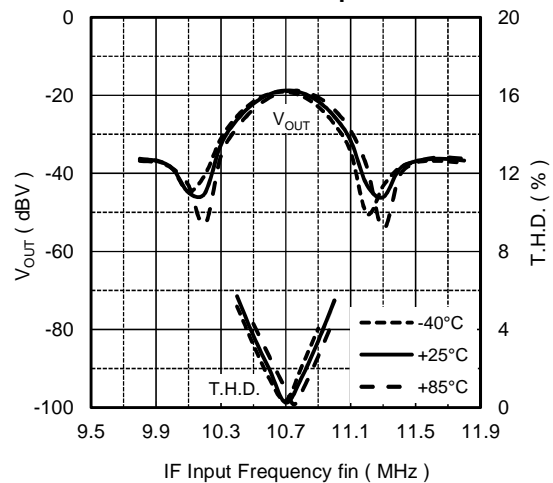

[CAUTION]

The specifications on this databook are only given for information, without any guarantee as regards either mistakes or omissions. The application circuits in this databook are described only to show representative usages of the product and not intended for the guarantee or permission of any right including the industrial rights.