

## SURFACE MOUNT SCHOTTKY BARRIER DIODE

### Features

- Low Forward Voltage
- Fast Switching
- Ultra-Small Surface Mount Package

### PINNING

PIN	DESCRIPTION
1	Cathode
2	Anode

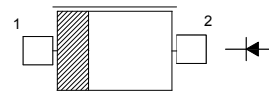

Top View

Simplified outline SOD-323 and symbol

### Absolute Maximum Ratings ( $T_a = 25\text{ }^\circ\text{C}$ )

Parameter	Symbol	Value	Unit
Repetitive Peak Reverse Voltage	$V_{RRM}$	30	V
Reverse Voltage	$V_R$	30	V
Average Rectified Output Current	$I_O$	100	mA
Forward Continuous Current	$I_{FM}$	200	mA
Repetitive Peak Forward Current at $t < 1\text{ s}$	$I_{FRM}$	500	mA
Non-repetitive Peak Forward Surge Current at $t < 10\text{ ms}$	$I_{FSM}$	2	A
Power Dissipation	$P_{tot}$	160	mW
Thermal Resistance, Junction to Ambient	$R_{\theta JA}$	625	$^\circ\text{C/W}$
Junction Temperature	$T_j$	- 55 to + 125	$^\circ\text{C}$
Storage Temperature Range	$T_{Stg}$	- 55 to + 125	$^\circ\text{C}$

### Characteristics at $T_a = 25\text{ }^\circ\text{C}$

Parameter	Symbol	Min.	Max.	Unit
Reverse Breakdown Voltage at $I_R = 100\text{ }\mu\text{A}$	$V_{(BR)R}$	30	-	V
Reverse Current at $V_R = 25\text{ V}$	$I_R$	-	500	nA
Forward Voltage at $I_F = 200\text{ mA}$ at $I_F = 10\text{ mA}$ at $I_F = 50\text{ mA}$ at $I_F = 2\text{ mA}$ at $I_F = 15\text{ mA}$	$V_F$	- - - 0.26 -	1 0.4 0.65 0.33 0.45	V
Total Capacitance at $V_R = 1\text{ V}$ , $f = 1\text{ MHz}$	$C_T$	-	10	pF
Reverse Recovery Time at $I_F = I_R = 10\text{ mA}$ , $I_{RR} = 0.1 \times I_R$ , $R_L = 100\text{ }\Omega$	$t_{rr}$	-	5	ns

**Typical Characteristics**

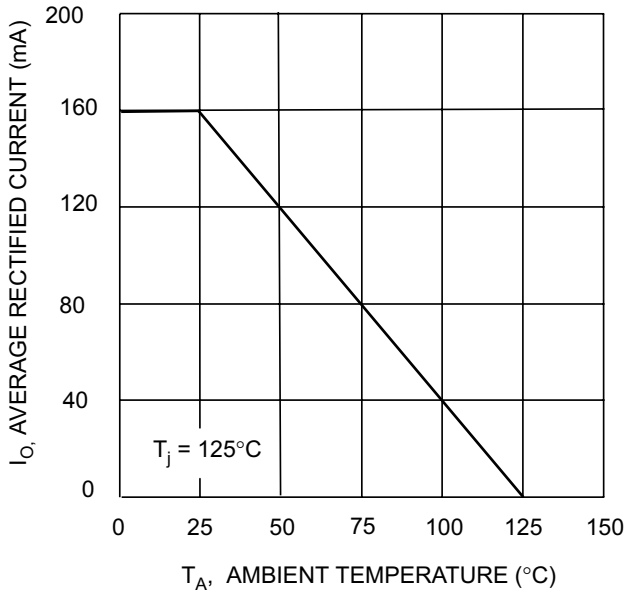

Fig. 1 Forward Current Derating Curve

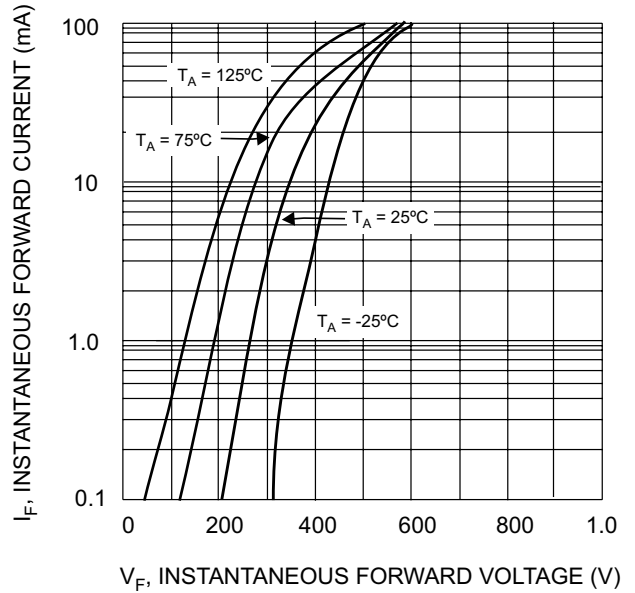

Fig. 2 Typical Forward Characteristics

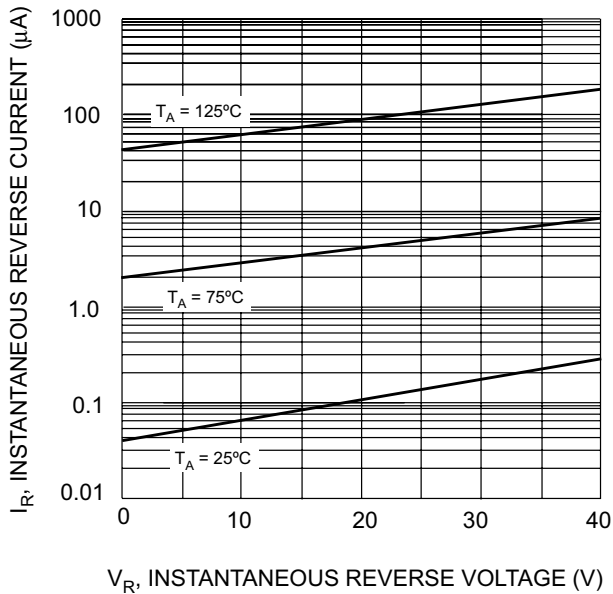

Fig. 3 Typical Reverse Characteristics

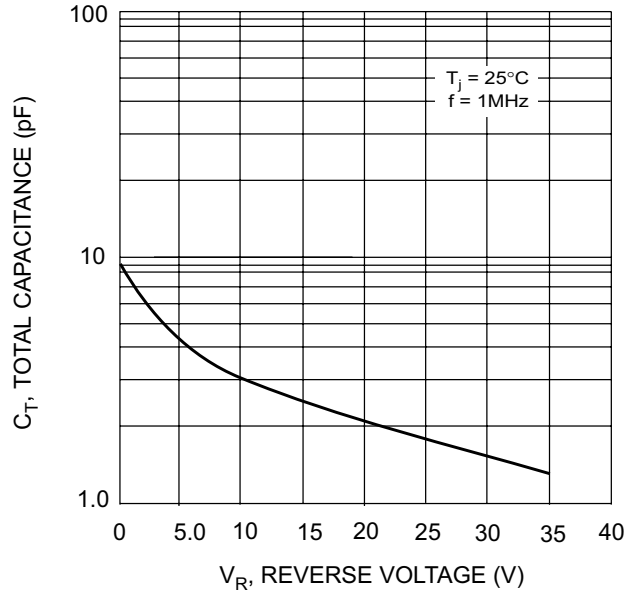
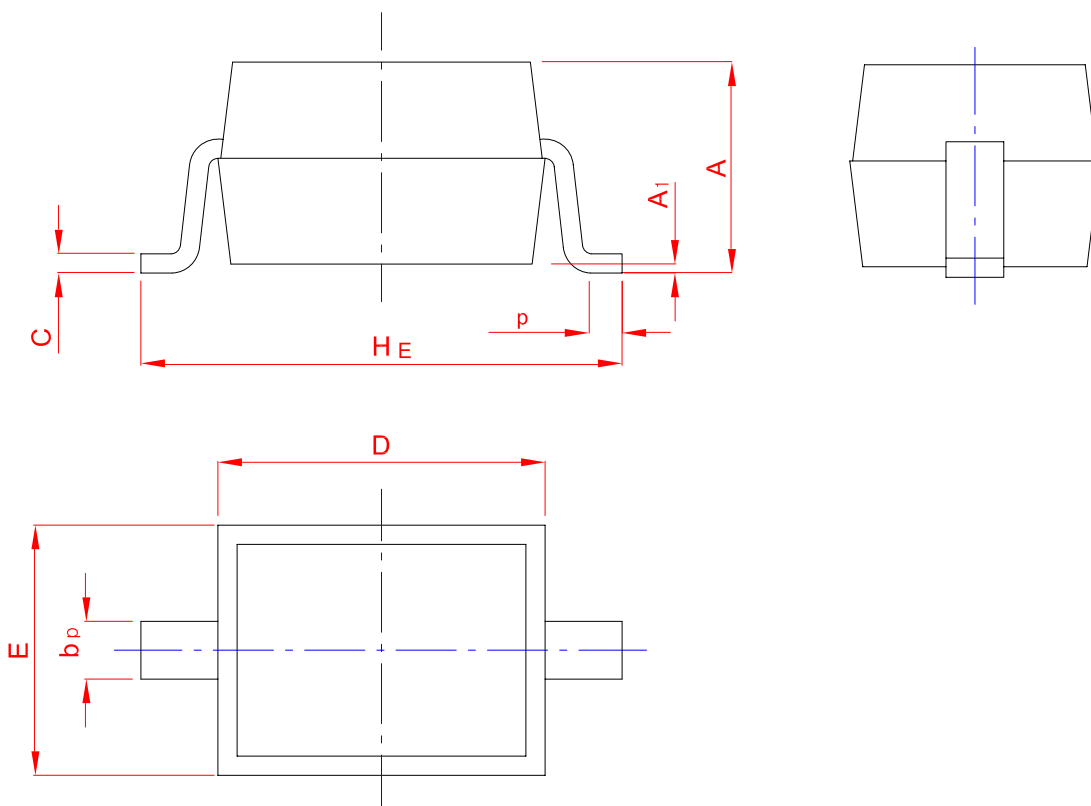
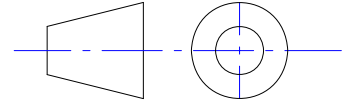

Fig. 4 Total Capacitance vs. Reverse Voltage

**PACKAGE OUTLINE**

Plastic surface mounted package; 2 leads

SOD-323



UNIT	A	b <sub>p</sub>	C	D	E	H <sub>E</sub>	A <sub>1</sub>	L <sub>p</sub>
mm	1.20	0.40	0.15	1.80	1.35	2.80	0.10	0.50
	0.90	0.25	0.10	1.60	1.15	2.30	0.01	0.20