

EC103xx and SxSx Series

0.8 A Sensitive SCRs

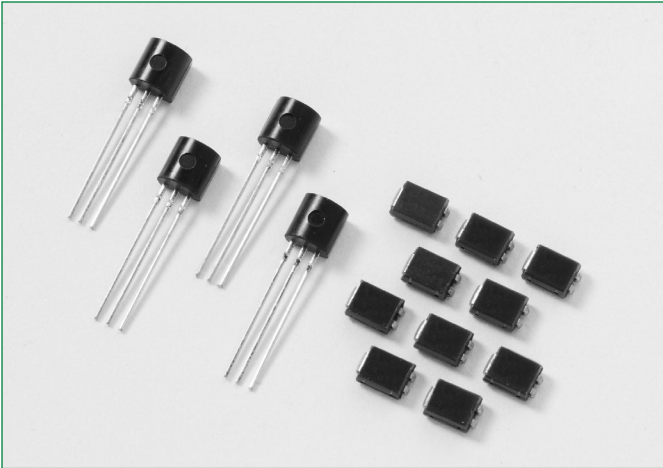

Description:

Excellent unidirectional switches for phase control applications such as heating and motor speed controls.

Sensitive gate SCRs are easily triggered with microAmps of current as furnished by sense coils, proximity switches, and microprocessors.

Features and Benefits:

- RoHS compliant
- Voltage capability up to 600 V
- Glass-passivated junctions
- Surge capability up to 20 A

Applications:

Typical applications are capacitive discharge systems for strobe lights and gas engine ignition. Also controls for power tools, home/brown goods and white goods appliances.

Product Summary

Characteristic	Value	Unit
$I_{T(RMS)}$	0.8	A
V_{DRM}/V_{RRM}	400 to 600	V
I_{GT}	12 to 500	μ A

Schematic Symbol

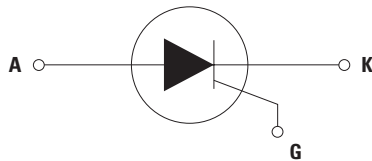

Absolute Maximum Ratings – Sensitive SCRs

Symbol	Characteristics	Conditions	Value	Units
$I_{T(RMS)}$	RMS On-state Current	$T_C = 75^\circ\text{C}$	0.8	A
$I_{T(AV)}$	Average On-state Current	$T_C = 75^\circ\text{C}$	0.51	
I_{TSM}	Peak Non-repetitive Surge Current	Single Half Cycle, $f = 50\text{ Hz}$, $T_J(\text{initial}) = 25^\circ\text{C}$	16	A
		Single Half Cycle, $f = 60\text{ Hz}$, $T_J(\text{initial}) = 25^\circ\text{C}$	20	
I^2t	I^2t Value for Fusing	$t_p = 8.3\text{ ms}$	1.6	A^2s
di/dt	Critical Rate-of-Rise of On-state Current	$T_J = 110^\circ\text{C}$ $f = 60\text{ Hz}$	50	$\text{A}/\mu\text{s}$
I_{GM}	Peak Gate Current	$T_J = 110^\circ\text{C}$	1	A
$P_{G(AV)}$	Average Gate Power Dissipation	$T_J = 110^\circ\text{C}$	0.1	W
T_{stg}	Storage Temperature Range	–	–40 to 150	$^\circ\text{C}$
T_J	Operating Junction Temperature Range	–	–40 to 110	$^\circ\text{C}$

Electrical Characteristics ($T_J = 25^\circ\text{C}$ unless otherwise specified)

Symbol	Characteristic	Conditions		Value				Unit	
				SxS1 EC103X1	SxS2 EC103X2	SxS/ 2N6565 EC103X	SxS3 EC103X3		
I_{GT}	Gate Trigger Current	$V_D = 6\text{ V}$ $R_L = 100\ \Omega$	Max.	12	50	200	500	μA	
V_{GT}	Gate Trigger Voltage		Max.	0.8				V	
V_{GRM}	Peak Reverse Gate Voltage	$I_{RG} = 10\ \mu\text{A}$	Min.	5				V	
dv/dt	Critical Rate of Rise of Off-stage Voltage	$V_D = V_{DRM}$; $R_{GK} = 1\text{ k}\Omega$	Min.	400 V	20	25	30	40	$\text{V}/\mu\text{s}$
				600 V	10	10	15	20	
V_{GD}	Gate Non-trigger Voltage	$V_D = V_{DRM}$; $R_L = 3.3\text{ k}\Omega$ $T_J = 110^\circ\text{C}$	Min.	0.2	0.25			V	
I_H	Holding Current	$I_T = 20\text{ mA}$ (initial); $R_{GK} = 1\text{ k}\Omega$	Max.	5			8	mA	
t_q	Turn-off Time	$I_T = 1\text{ A}$; $t_p = 50\ \mu\text{s}$; $dv/dt = 5\text{ V}/\mu\text{s}$; $di/dt = 5\text{ A}/\mu\text{s}$	Max.	60		50	45	μs	
t_{gt}	Turn-on Time	$I_G = 2 \times I_{GT}$ $P_W = 15\ \mu\text{s}$ $I_T = 1.6\text{ A}$	Typ.	2	5	20	30	μs	

Static Characteristics

Symbol	Characteristic	Conditions	Value			Unit	
			Min.	Typ.	Max.		
V_{TM}	Peak On-state Voltage Drop	$I_T = 1.2\text{ A}$; $t_p = 380\ \mu\text{s}$	–	–	1.4	V	
I_{DRM}/I_{RRM}	Repetitive Peak Off-state Current	$V_{DRM} = V_{RRM}$ $R_{GK} = 1\text{ k}\Omega$	$T_J = 25^\circ\text{C}$	–	–	1	μA
			$T_J = 100^\circ\text{C}$	–	–	50	
			$T_J = 110^\circ\text{C}$	–	–	100	

Thermal Resistances

Symbol	Characteristic	Conditions	Value	Unit
$R_{\theta(JC)}$	Thermal Resistance, Junction to case (AC)	EC103xy/2N6565 ²	75	$^\circ\text{C}/\text{W}$
		SxSy ²	60 ¹	
$R_{\theta(JA)}$	Thermal Resistance, Junction to ambient	EC103xy/2N6565 ²	160	$^\circ\text{C}/\text{W}$

Notes 1: Mounted on 1 cm² copper (two-ounce) foil surface

2: x = voltage, y = sensitivity

Characteristic Curves

Fig. 1. Normalized DC Gate Trigger Current vs. Junction Temperature

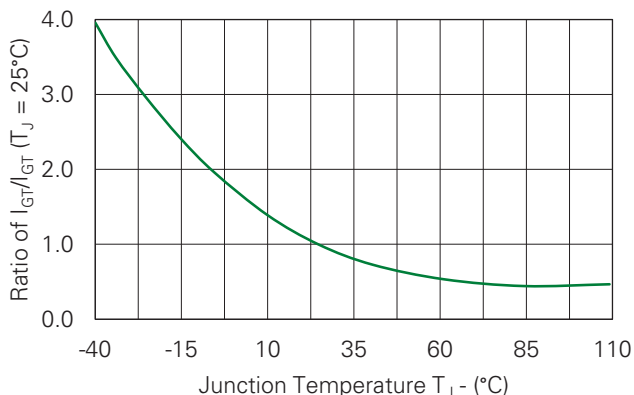

Fig. 2. Normalized DC Gate Trigger Voltage vs. Junction Temperature

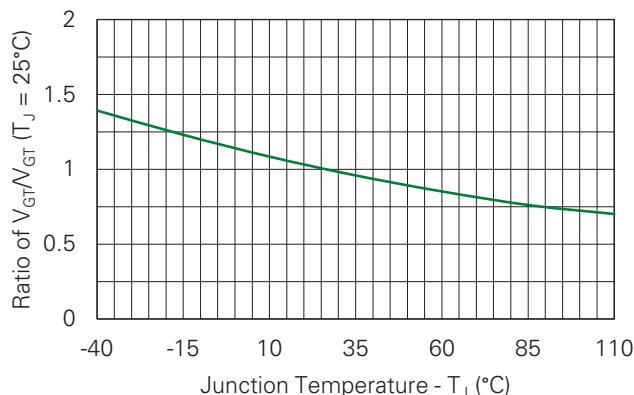

Fig. 3. Normalized DC Holding Current vs. Junction Temperature

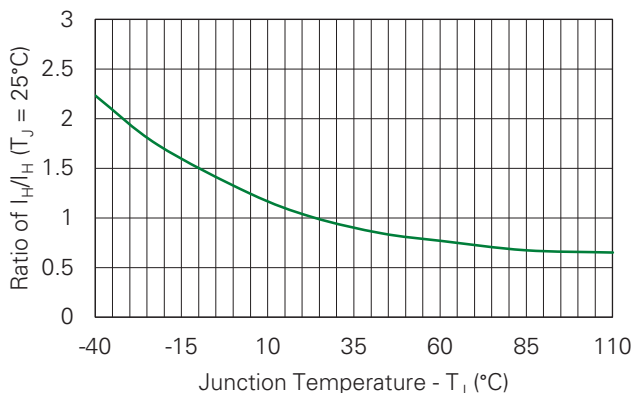

Fig. 4. Typical On-state Current vs. On-state Voltage

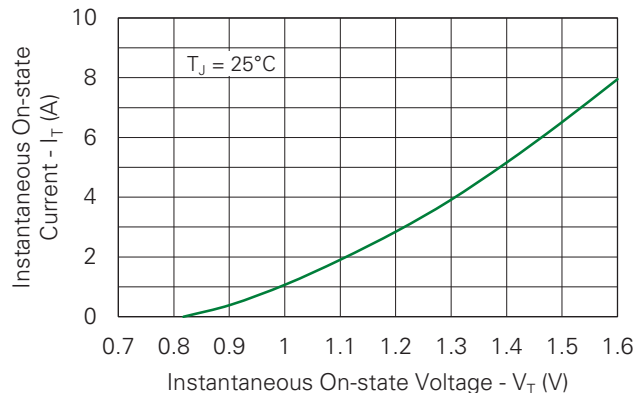

Fig. 5. Typical Power Dissipation vs. RMS On-state Current

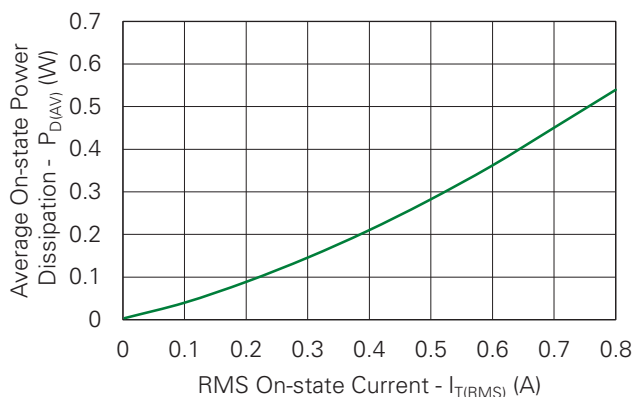

Fig. 6. Maximum Allowable Case Temperature vs. RMS On-state Current

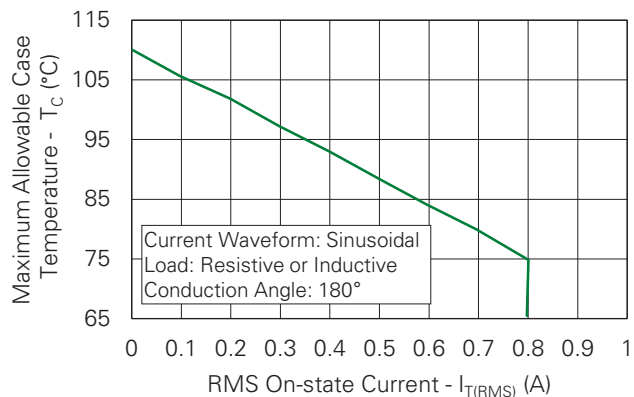

Fig. 7. Maximum Allowable Case Temperature vs. Average On-state Current

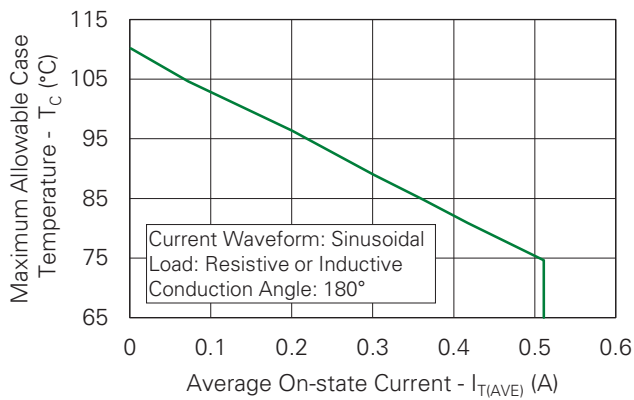

Fig. 8. Maximum Allowable Ambient Temperature vs. RMS On-state Current

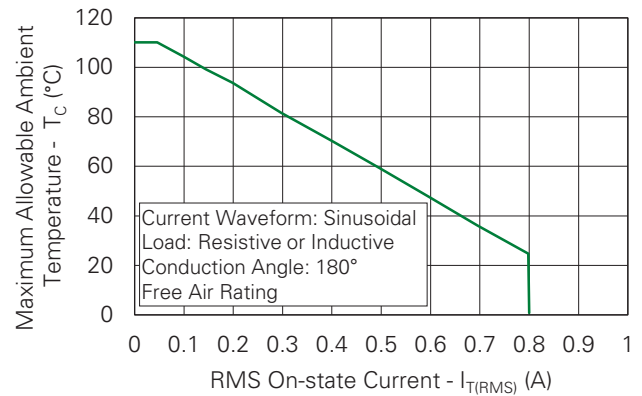

Fig. 9. Maximum Allowable Ambient Temperature vs. Average On-state Current

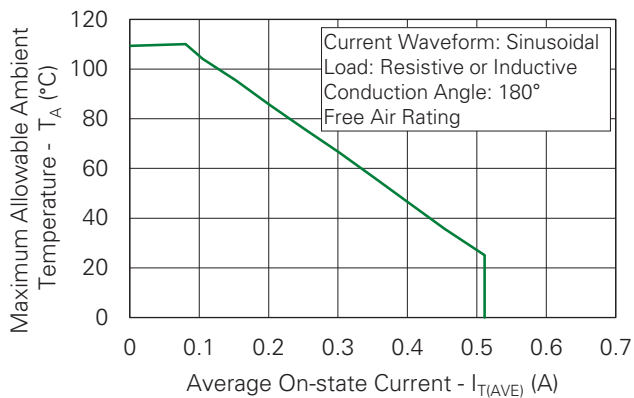

Fig. 10. Peak Capacitor Discharge Current

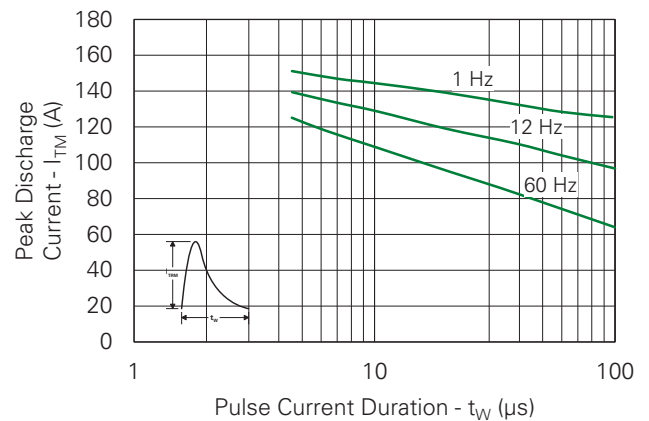

Fig. 11. Peak Repetitive Sinusoidal Pulse Current

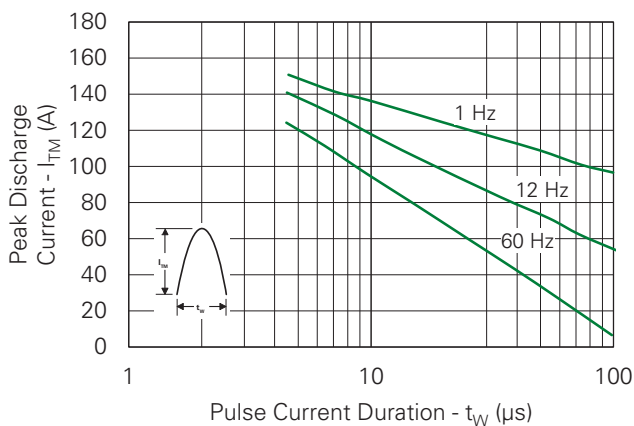

Fig. 12-1. Typical DC Gate Trigger Current with R_{GK} vs. Junction Temperature for EC103x

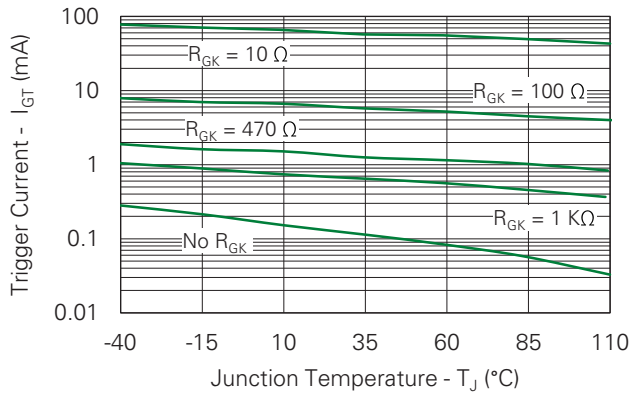

Fig. 12-2. Typical DC Gate Trigger Current with R_{GK} vs. Junction Temperature for EC103x1

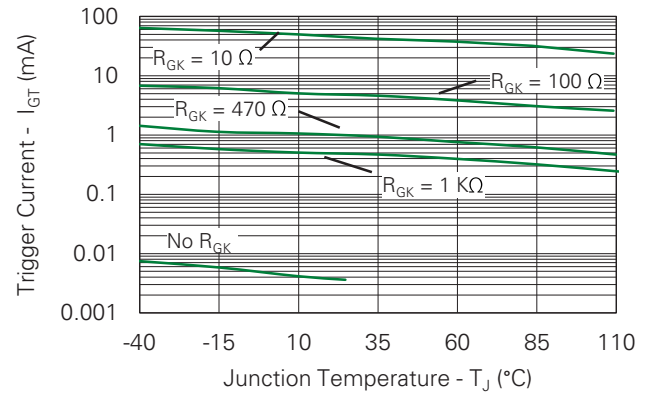

Fig. 13-1. Typical DC Holding Current with R_{GK} vs. Junction Temperature for EC103x

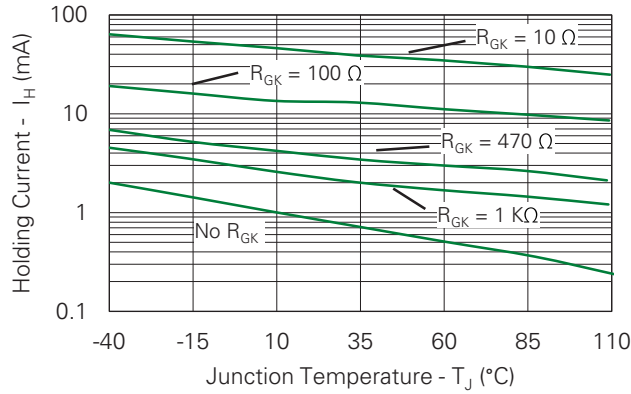

Fig. 13-2. Typical DC Holding Current with R_{GK} vs. Junction Temperature for EC103x1

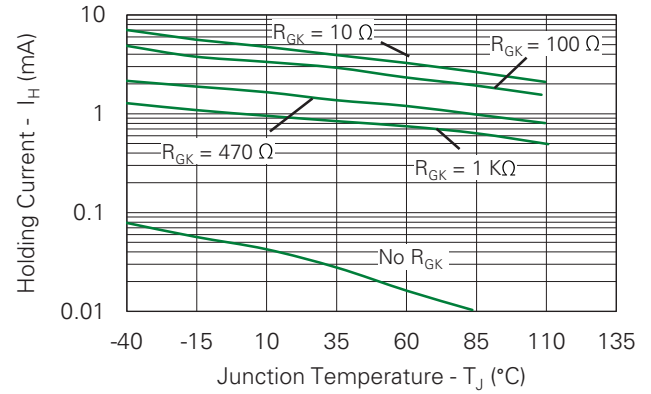

Fig. 14-1. Typical Static dv/dt with R_{GK} vs. Junction Temperature for EC103x

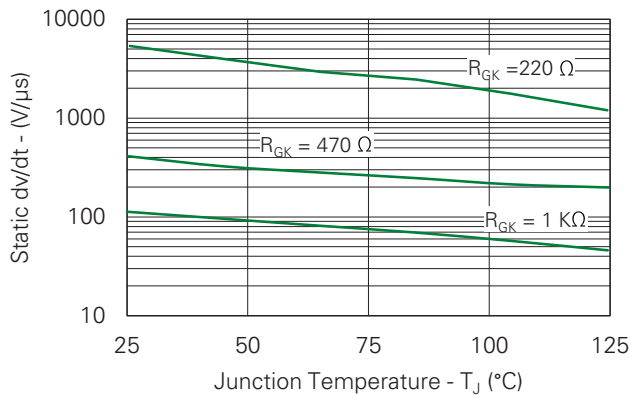

Fig. 14-2. Typical Static dv/dt with R_{GK} vs. Junction Temperature for EC103x1

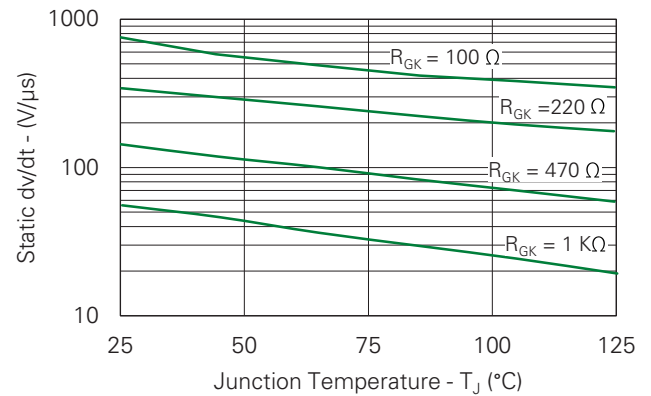

Fig. 15-1. Typical turn-off time with R_{GK} vs. Junction Temperature for EC103x

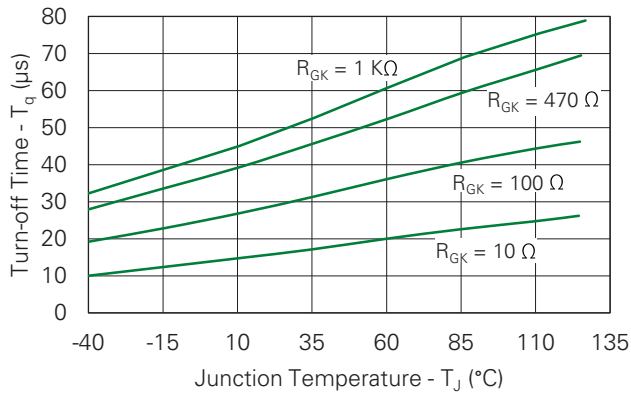

Fig. 15-2. Typical turn-off time with R_{GK} vs. Junction Temperature for EC103x1

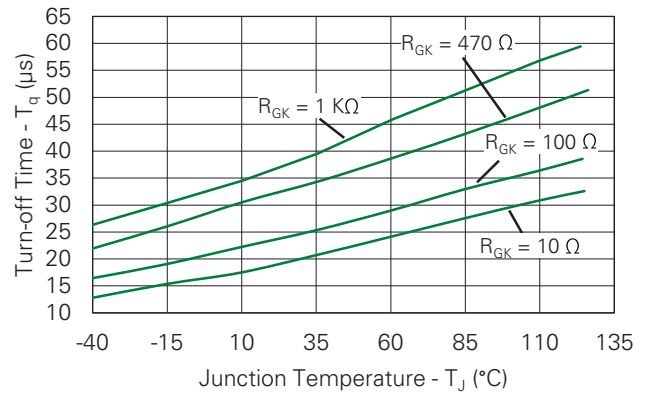
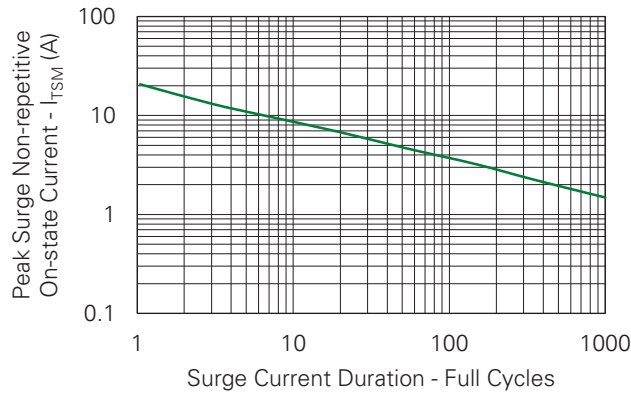

Fig. 16. Surge Peak On-state Current vs. Number of Cycles



SUPPLY FREQUENCY: 60 Hz Sinusoidal
 LOAD: Resistive
 RMS On-State Current: [$I_{T(RMS)}$]: Maximum Rated Value at Specified Case Temperature

- Notes:
1. Gate control may be lost during and immediately following surge current interval.
 2. Overload may not be repeated until junction temperature has returned to steady-state rated value.

Soldering Parameters

Characteristic		Value
Reflow Condition		Pb – Free assembly
Pre-heat	Temperature Min ($T_{s(min)}$)	150°C
	Temperature Max ($T_{s(max)}$)	200°C
	Time (min to max) (t_s)	60 – 120 secs
Average ramp up rate (Liquidus Temp)(T_L) to peak		3°C/second max
$T_{s(max)}$ to T_L - Ramp-up Rate		3°C/second max
Reflow	Temperature (T_L) (Liquidus)	217°C
	Time (t_L)	60 – 150 seconds
Peak Temperature (T_p)		260 ^{+0/-5} °C
Time within 5°C of actual peak Temperature (t_p)		30 seconds max
Ramp-down Rate		6°C/second max
Time 25°C to peak Temperature (T_p)		8 minutes max
Do Not Exceed		260°C

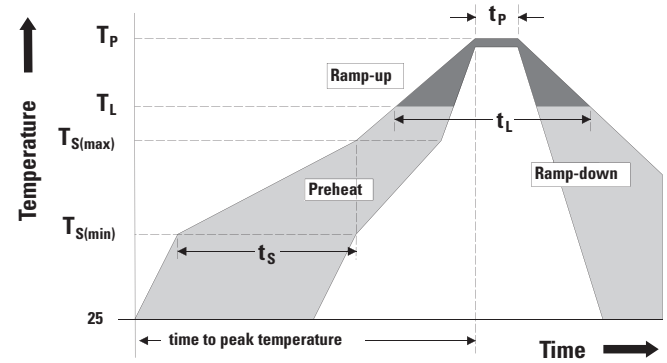

Physical Specifications

Characteristic	Value
Terminal Finish	100% Matte Tin-plated/ Pb-free Solder Dipped
Body Material	UL Recognized compound meeting flammability rating V-0
Lead Material	Copper Alloy

Design Considerations

Careful selection of the correct component for the application’s operating parameters and environment will go a long way toward extending the operating life of the Thyristor. Good design practice should limit the maximum continuous current through the main terminals to 75% of the component rating. Other ways to ensure long life for a power discrete semiconductor are proper heat sinking and selection of voltage ratings for worst case conditions. Overheating, overvoltage (including dv/dt), and surge currents are the main killers of semiconductors. Correct mounting, soldering, and forming of the leads also help protect against component damage.

Environmental Specifications

Test	Specifications and Conditions
AC Blocking	MIL-STD-750, M-1040, Cond A Applied Peak AC voltage @110°C for 1008 hours
Temperature/Humidity	EIA / JEDEC, JESD22-A101, 1008 hours; 320V - DC: 85°C; 85% relative humidity
Temperature Cycling	MIL-STD-750, M-1051, 100 cycles; -40°C to +150°C; 15-min dwell-time
High Temp Storage	MIL-STD-750, M-1031, 1008 hours, 150°C
Low Temp Storage	1008 hours, -40°C
Resistance to Solder Heat	MIL-STD-750 Method 2031
Solderability	ANSI/J-STD-002, category 3, Test A
Lead Bend	MIL-STD-750, M-2036 Cond E

Part Outline Drawing (TO-92) (E Package)

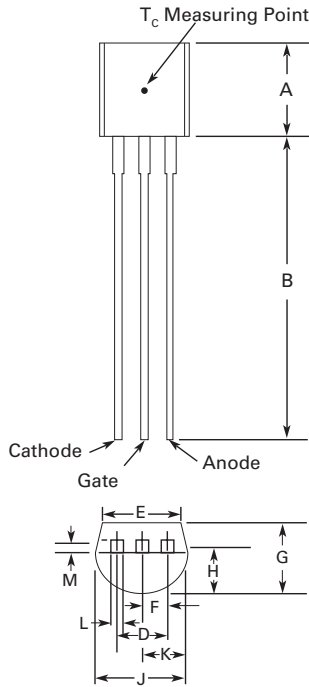

Symbol	Inches			Millimeters		
	Min.	Typical	Max.	Min.	Typical	Max.
A	0.176	–	0.196	4.47	–	4.98
B	0.500	–	–	12.70	–	–
D	0.095	–	0.105	2.41	–	2.67
E	0.150	–	–	3.81	–	–
F	0.046	–	0.054	1.16	–	1.37
G	0.135	–	0.145	3.43	–	3.68
H	0.088	–	0.096	2.23	–	2.44
J	0.176	–	0.186	4.47	–	4.73
K	0.088	–	0.096	2.23	–	2.44
L	0.013	–	0.019	0.33	–	0.48
M	0.013	–	0.017	0.33	–	0.43

All leads insulated from case. Case is electrically nonconductive.

Part Outline Drawing (Compak) (C Package)

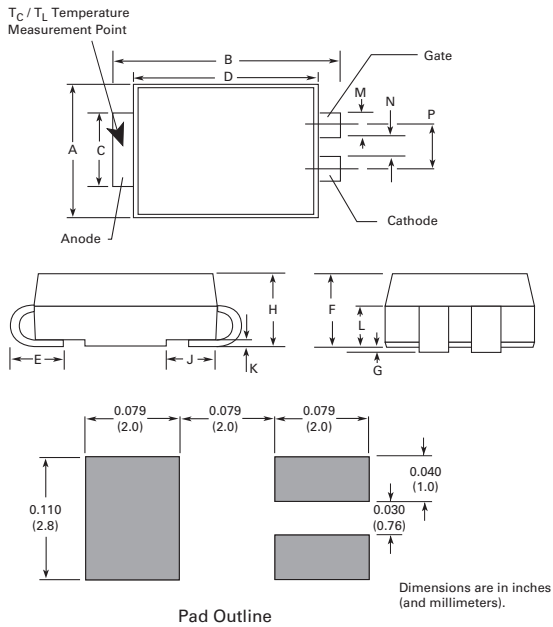

Symbol	Inches			Millimeters		
	Min.	Typical	Max.	Min.	Typical	Max.
A	0.130	–	0.156	3.30	–	3.95
B	0.201	–	0.220	5.10	–	5.60
C	0.077	–	0.087	1.95	–	2.20
D	0.159	–	0.181	4.05	–	4.60
E	0.030	–	0.063	0.75	–	1.60
F	0.075	–	0.096	1.90	–	2.45
G	0.002	–	0.008	0.05	–	0.20
H	0.077	–	0.104	1.95	–	2.65
J	0.043	–	0.053	1.09	–	1.35
K	0.006	–	0.016	0.15	–	0.41
L	0.030	–	0.055	0.76	–	1.40
M	0.022	–	0.028	0.56	–	0.71
N	0.027	–	0.033	0.69	–	0.84
P	0.052	–	0.058	1.32	–	1.47

Product Selector

Part Number	Voltage		Gate Sensitivity	Type	Package
	400 V	600 V			
EC103 x 1	X	X	12 μ A	Sensitive SCR	TO-92
EC103 x 2	X	X	50 μ A	Sensitive SCR	TO-92
EC103 x	X / 2N6565	X	200 μ A	Sensitive SCR	TO-92
EC103 x 3	X	X	500 μ A	Sensitive SCR	TO-92
S x S1	X	X	12 μ A	Sensitive SCR	Compak
S x S2	X	X	50 μ A	Sensitive SCR	Compak
S x S	X	X	200 μ A	Sensitive SCR	Compak
S x S3	X	X	500 μ A	Sensitive SCR	Compak

Note: x = voltage

Packing Options

Part Number	Marking	Weight	Packing Mode	Base Quantity
EC103xy/ 2N6565	EC103xy/ 2N6565	0.19 g	Bulk	2000
EC103xyRP	EC103xy	0.19 g	Reel Pack	2000
EC103xyAP	EC103xy	0.19 g	Ammo Pack	2000
SxSyRP	SxSy	0.08 g	Embossed Carrier	2500

Note: x = voltage, y = sensitivity

TO-92 (3-lead) Reel Pack (RP) Radial Leaded Specifications
Meets all EIA-468-C Standards

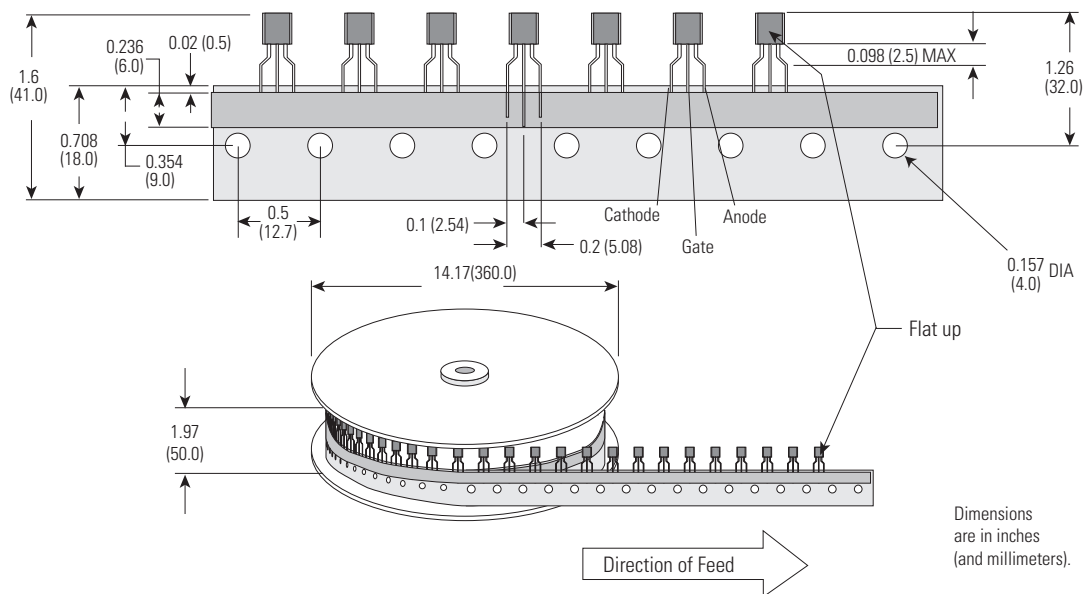

Dimensions are in inches (and millimeters).

TO-92 (3-lead) Ammo Pack (AP) Radial Leaded Specifications

Meets all EIA-468-C Standards

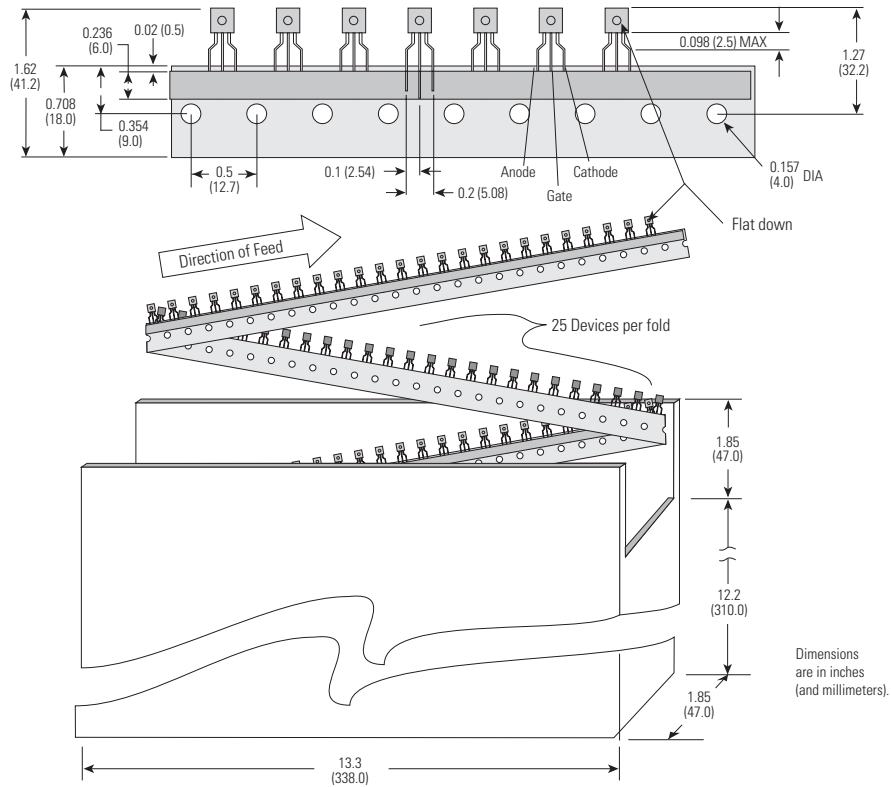

Compak Embossed Carrier Reel Pack (RP) Specifications

Meets all EIA-481-1 Standards

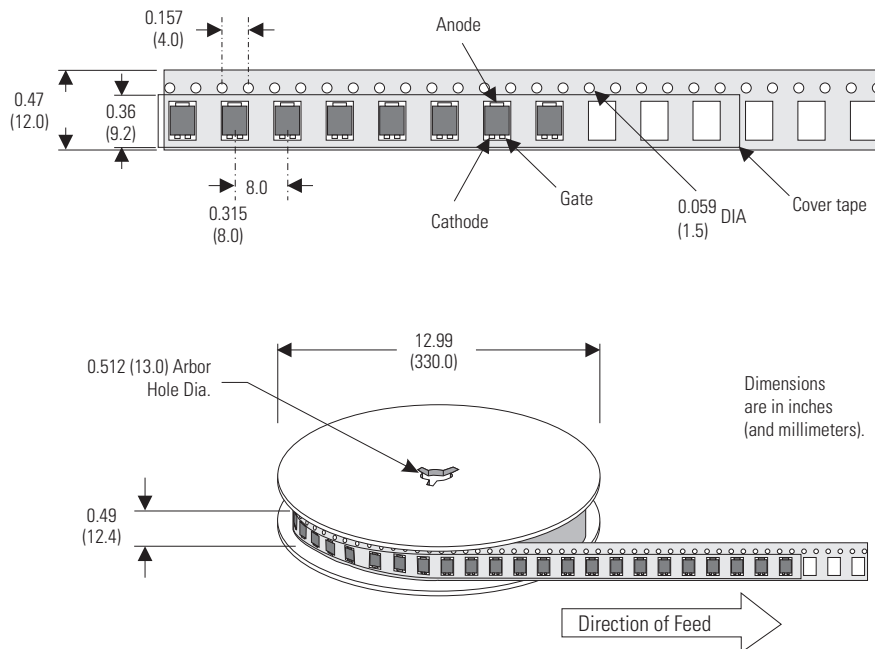

Part Numbering and Marking (TO-92)

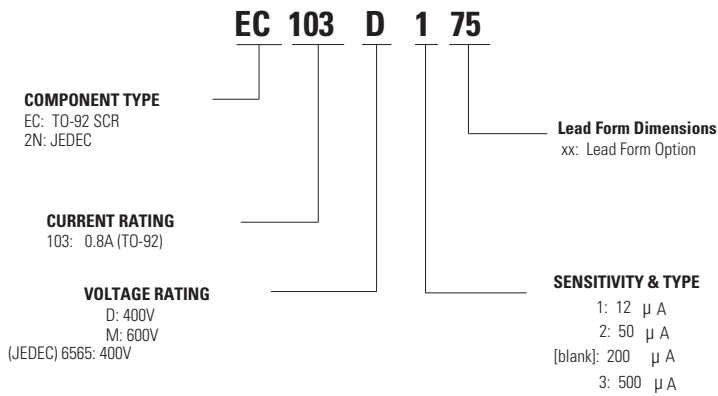

TO-92 (E Package)

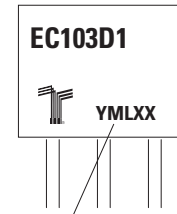

Date Code Marking
Y: Year Code
M: Month Code
L: Location Code
XX: Lot Serial Code

Part Numbering and Marking (Compak)

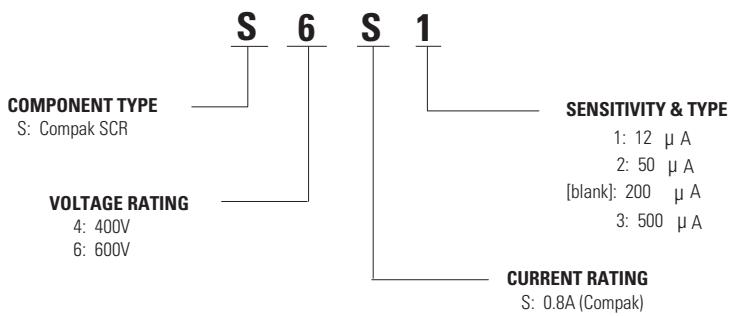

Compak (C Package)



Date Code Marking
Y: Year Code
M: Month Code
XXX: Lot Trace Code

Disclaimer Notice

Information furnished is believed to be accurate and reliable. However, users should independently evaluate the suitability of and test each product selected for their own applications. Littelfuse products are not designed for, and may not be used in, all applications. Read complete Disclaimer Notice at <http://www.littelfuse.com/disclaimer-electronics>.



Part of:

