

LC717A00AR

Capacitance-Digital-Converter LSI for Electrostatic Capacitive Touch Sensors

Overview

The LC717A00AR is a high-performance, low-cost capacitance-digital-converter LSI for electrostatic capacitive touch sensor, especially focused on usability. It has 8 channels capacitance-sensor input. The built-in logic circuit can detect the state (ON/OFF) of each input and output the result. This makes it ideal for various switch applications.

The calibration function is automatically performed by the built-in logic circuit during power activation or whenever there are environmental changes. In addition, since initial settings of parameters, such as gain, are configured, LC717A00AR can operate as stand-alone when the recommended switch pattern is applied.

Also, since LC717A00AR has a serial interface compatible with I²C™ and SPI bus, parameters can be adjusted using external devices whenever necessary. Moreover, outputs of the 8-input capacitance data can be detected and measured as 8-bit data.

Features

- Detection System: Differential Capacitance Detection (Mutual Capacitance Type)
- Input Capacitance Resolution: Can Detect Capacitance Changes in the Femto Farad Order
- Measurement Interval (8 Differential Inputs):
 - ◆ 18 ms (Typ) (at Initial Configuration)
 - ◆ 3 ms (Typ) (at Minimum Interval Configuration)
- External Components for Measurement: Not Required
- Current Consumption:
 - ◆ 320 μA (Typ) (V_{DD} = 2.8 V)
 - ◆ 740 μA (Typ) (V_{DD} = 5.5 V)
- Supply Voltage: 2.6 V to 5.5 V
- Detection Operations: Switch
- Packages: VCT28
- Interface: I²C Compatible Bus or SPI Selectable



ON Semiconductor®

www.onsemi.com

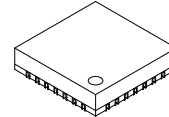

VCT28
CASE 601AE

MARKING DIAGRAM

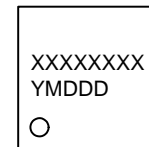

XXXXX = Specific Device Code
Y = Year
M = Month
DDD = Additional Traceability Data

ORDERING INFORMATION

See detailed ordering and shipping information on page 11 of this data sheet.

LC717A00AR

Specifications

Table 1. ABSOLUTE MAXIMUM RATINGS ($T_A = 25^\circ\text{C}$, $V_{SS} = 0\text{ V}$)

Parameter	Symbol	Ratings	Unit	Remarks
Supply Voltage	V_{DD}	-0.3 to +6.5	V	
Input Voltage	V_{IN}	-0.3 to $V_{DD} + 0.3$	V	(Note 1)
Output Voltage	V_{OUT}	-0.3 to $V_{DD} + 0.3$	V	(Note 2)
Power Dissipation	$P_{d\max}$	160	mW	$T_A = +105^\circ\text{C}$, Mounted on a substrate (Note 3)
Peak Output Current	I_{OP}	± 8	mA	Per terminal, 50% Duty ratio (Note 2)
Total Output Current	I_{OA}	± 40	mA	Output total value of LSI, 25% Duty ratio
Storage Temperature	T_{stg}	-55 to +125	$^\circ\text{C}$	

Stresses exceeding those listed in the Maximum Ratings table may damage the device. If any of these limits are exceeded, device functionality should not be assumed, damage may occur and reliability may be affected.

1. Apply to C_{in0} to 7, C_{ref} , $nRST$, SCL , SDA , SA , SCK , SI , nCS , $GAIN$.
2. Apply to C_{drv} , P_{out0} to 7, SDA , SO , $ERROR$, $INTOUT$.
3. 4-layer glass epoxy board ($40 \times 50 \times 0.8\text{t mm}$).

Table 2. RECOMMENDED OPERATING CONDITIONS

Parameter	Symbol	Conditions	Min	Typ	Max	Unit	Remarks
Operating Supply Voltage	V_{DD}		2.6	-	5.5	V	
Supply Ripple + Noise	V_{PP}		-	-	± 20	mV	(Note 4)
Operating Temperature	T_{opr}		-40	25	105	$^\circ\text{C}$	

Functional operation above the stresses listed in the Recommended Operating Ranges is not implied. Extended exposure to stresses beyond the Recommended Operating Ranges limits may affect device reliability.

4. Inserting a high-valued capacitor and a low-valued capacitor in parallel between V_{DD} and V_{SS} is recommended. In this case, the small-valued capacitor should be at least $0.1\ \mu\text{F}$, and is mounted near the LSI.

Table 3. ELECTRICAL CHARACTERISTICS

($V_{SS} = 0\text{ V}$, $V_{DD} = 2.6$ to 5.5 V , $T_A = -40$ to $+105^\circ\text{C}$, Unless otherwise specified, the C_{drv} drive frequency is $f_{CDRV} = 143\text{ kHz}$.

Not tested at low temperature before shipment.)

Parameter	Symbol	Conditions	Min	Typ	Max	Unit	Remarks
Capacitance Detection Resolution	N		-	-	8	bit	
Output Noise RMS	N_{RMS}	Minimum gain setting	-	-	± 1.0	LSB	(Notes 5, 7)
Input Offset Capacitance Adjustment Range	$C_{offRANGE}$		-	± 8.0	-	pF	(Notes 5, 7)
Input Offset Capacitance Adjustment Resolution	$C_{offRESO}$		-	8	-	bit	
C_{in} Offset Drift	$C_{inDRIFT}$	Minimum gain setting	-	-	± 8	LSB	(Note 5)
C_{in} Detection Sensitivity	$C_{inSENSE}$	Minimum gain setting	0.04	-	0.12	LSB/fF	(Note 6)
C_{in} Pin Leak Current	I_{Cin}	$C_{in} = Hi-Z$	-	± 25	± 500	nA	
C_{in} Allowable Parasitic Input Capacitance	C_{inSUB}	C_{in} against V_{SS}	-	-	30	pF	(Notes 5, 7)
C_{drv} Drive Frequency	f_{CDRV}		100	143	186	kHz	
C_{drv} Pin Leak Current	I_{CDRV}	$C_{drv} = Hi-Z$	-	± 25	± 500	nA	
$nRST$ Minimum Pulse Width	t_{NRST}		1	-	-	μs	
Power-on Reset Time	t_{POR}		-	-	20	ms	
Power-on Reset Operation Condition: Hold Time	t_{POROP}		10	-	-	ms	(Note 5)
Power-on Reset Operation Condition: Input Voltage	V_{POROP}		-	-	0.1	V	(Note 5)

LC717A00AR

Table 3. ELECTRICAL CHARACTERISTICS (continued)

($V_{SS} = 0\text{ V}$, $V_{DD} = 2.6\text{ to }5.5\text{ V}$, $T_A = -40\text{ to }+105^\circ\text{C}$, Unless otherwise specified, the Cdrv drive frequency is $f_{CDRV} = 143\text{ kHz}$. Not tested at low temperature before shipment.)

Parameter	Symbol	Conditions	Min	Typ	Max	Unit	Remarks
Power-on Reset Operation Condition: Power Supply Rise Rate	t_{VDD}	0 V to V_{DD}	1	–	–	V/ms	(Note 5)
Pin Input Voltage	V_{IH}	High input	$0.8 V_{DD}$	–	–	V	(Notes 5, 8)
	V_{IL}	Low input	–	–	$0.2 V_{DD}$		
Pin Output Voltage	V_{OH}	High output ($I_{OH} = +3\text{ mA}$)	$0.8 V_{DD}$	–	–	V	(Note 9)
	V_{OL}	Low output ($I_{OL} = -3\text{ mA}$)	–	–	$0.2 V_{DD}$		
SDA Pin Output Voltage	$V_{OL}^{I^2C}$	SDA Low output ($I_{OL} = -3\text{ mA}$)	–	–	0.4	V	
Pin Leak Current	I_{LEAK}		–	–	± 1	μA	(Note 10)
Current Consumption	I_{DD}	When stand-alone configuration and non-touch $V_{DD} = 2.8\text{ V}$	–	320	390	μA	(Notes 5, 7)
		When stand-alone configuration and non-touch $V_{DD} = 5.5\text{ V}$	–	740	900		
	I_{STBY}	During Sleep process	–	–	1	μA	(Note 7)

Product parametric performance is indicated in the Electrical Characteristics for the listed test conditions, unless otherwise noted. Product performance may not be indicated by the Electrical Characteristics if operated under different conditions.

5. Design-guaranteed values (not tested before shipment).
6. Measurements conducted using the test mode in the LSI.
7. $T_A = +25^\circ\text{C}$.
8. Apply to nRST, SCL, SDA, SA, SCK, SI, nCS, GAIN.
9. Apply to Cdrv, Pout0 to 7, SO, ERROR, INTOUT.
10. Apply to nRST, SCL, SDA, SA, SCK, SI, nCS, GAIN.

LC717A00AR

Table 4. I²C COMPATIBLE BUS TIMING CHARACTERISTICS

(V_{SS} = 0 V, V_{DD} = 2.6 to 5.5 V, T_A = -40 to +105°C, Not tested at low temperature before shipment.)

Parameter	Symbol	Pin Name	Conditions	Min	Typ	Max	Unit	Remarks
SCL Clock Frequency	f _{SCL}	SCL		–	–	400	kHz	
START Condition Hold Time	t _{HD;STA}	SCL, SDA		0.6	–	–	μs	
SCL Clock Low Period	t _{LOW}	SCL		1.3	–	–	μs	
SCL Clock High Period	t _{HIGH}	SCL		0.6	–	–	μs	
Repeated START Condition Setup Time	t _{SU;STA}	SCL, SDA		0.6	–	–	μs	(Note 11)
Data Hold Time	t _{HD;DAT}	SCL, SDA		0	–	0.9	μs	
Data Setup Time	t _{SU;DAT}	SCL, SDA		100	–	–	ns	(Note 11)
SDA, SCL Rise/Fall Time	t _r / t _f	SCL, SDA		–	–	300	ns	(Note 11)
STOP Condition Setup Time	t _{SU;STO}	SCL, SDA		0.6	–	–	μs	
STOP-to-START Bus Release Time	t _{BUF}	SCL, SDA		1.3	–	–	μs	(Note 11)

Product parametric performance is indicated in the Electrical Characteristics for the listed test conditions, unless otherwise noted. Product performance may not be indicated by the Electrical Characteristics if operated under different conditions.

11. Design-guaranteed values (not tested before shipment).

Table 5. SPI BUS TIMING CHARACTERISTICS

(V_{SS} = 0 V, V_{DD} = 2.6 to 5.5 V, T_A = -40 to +105°C, Not tested at low temperature before shipment.)

Parameter	Symbol	Pin Name	Conditions	Min	Typ	Max	Unit	Remarks
SCK Clock Frequency	f _{SCK}	SCK		–	–	5	MHz	
SCK Clock Low Time	t _{LOW}	SCK		90	–	–	ns	(Note 12)
SCK Clock High Time	t _{HIGH}	SCK		90	–	–	ns	(Note 12)
Input Signal Rise/Fall Time	t _r / t _f	nCS, SCK, SI		–	–	300	ns	(Note 12)
nCS Setup Time	t _{SU;NCS}	nCS, SCK		90	–	–	ns	(Note 12)
SCK Clock Setup Time	t _{SU;SCK}	nCS, SCK		90	–	–	ns	(Note 12)
Data Setup Time	t _{SU;SI}	SCK, SI		20	–	–	ns	(Note 12)
Data Hold Time	t _{HD;SI}	SCK, SI		30	–	–	ns	(Note 12)
nCS Hold Time	t _{HD;NCS}	nCS, SCK		90	–	–	ns	(Note 12)
SCK Clock Hold Time	t _{HD;SCK}	nCS, SCK		90	–	–	ns	(Note 12)
nCS Standby Pulse Width	t _{CPH}	nCS		90	–	–	ns	(Note 12)
Output High Impedance Time from nCS	t _{CHZ}	nCS, SO		–	–	80	ns	(Note 12)
Output Data Determination Time	t _v	SCK, SO		–	–	80	ns	(Note 12)
Output Data Hold Time	t _{HD;SO}	SCK, SO		0	–	–	ns	(Note 12)
Output Low Impedance Time from SCK Clock	t _{CLZ}	SCK, SO		0	–	–	ns	(Note 12)

Product parametric performance is indicated in the Electrical Characteristics for the listed test conditions, unless otherwise noted. Product performance may not be indicated by the Electrical Characteristics if operated under different conditions.

12. Design-guaranteed values (not tested before shipment).

LC717A00AR

Power-On Reset (POR)

When power is turned on, power-on reset is enabled inside the LSI and its state is released after a certain power-on reset time, t_{POR} . Power-on reset operation condition: Power supply rise rate t_{VDD} must be at least 1 V/ms.

Since INTOUT pin changes from “High” to “Low” at the same time as the released of power-on reset state, it is possible to verify the t_{POR} externally.

During power-on reset state, C_{in} , C_{ref} and P_{out} are unknown.

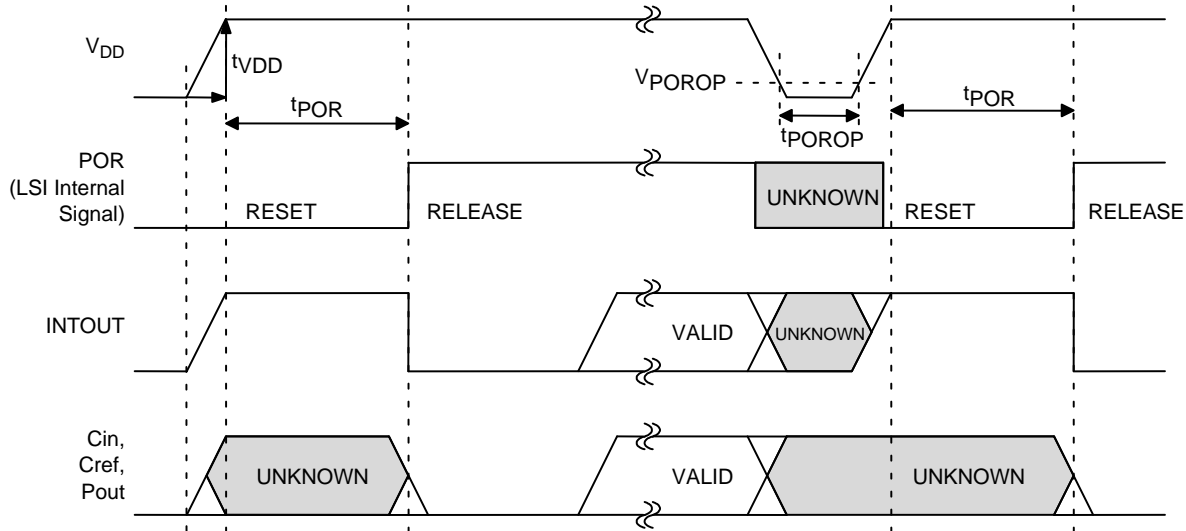

Figure 1.

I²C Compatible Bus Data Timing

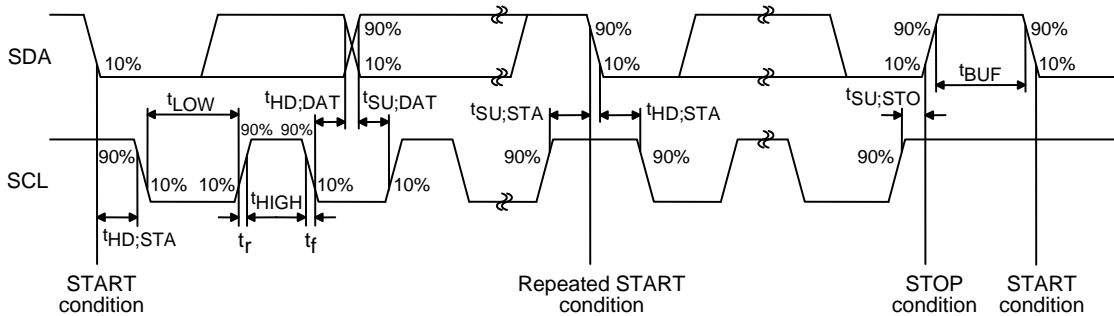

Figure 2.

I²C Compatible Bus Communication Formats

- Write format (data can be written into sequentially incremented addresses)



Figure 3.

- Read format (data can be read from sequentially incremented addresses)



Figure 4.

LC717A00AR

I²C Compatible Bus Slave Address

Selection of two kinds of addresses is possible through the SA terminal.

Table 6.

SA Pin Input	7-bit Slave Address	Binary Notation	8-bit Slave Address
Low	0x16	00101100b (Write)	0x2C
		00101101b (Read)	0x2D
High	0x17	00101110b (Write)	0x2E
		00101111b (Read)	0x2F

SPI Data Timing (SPI Mode 0 / Mode 3)

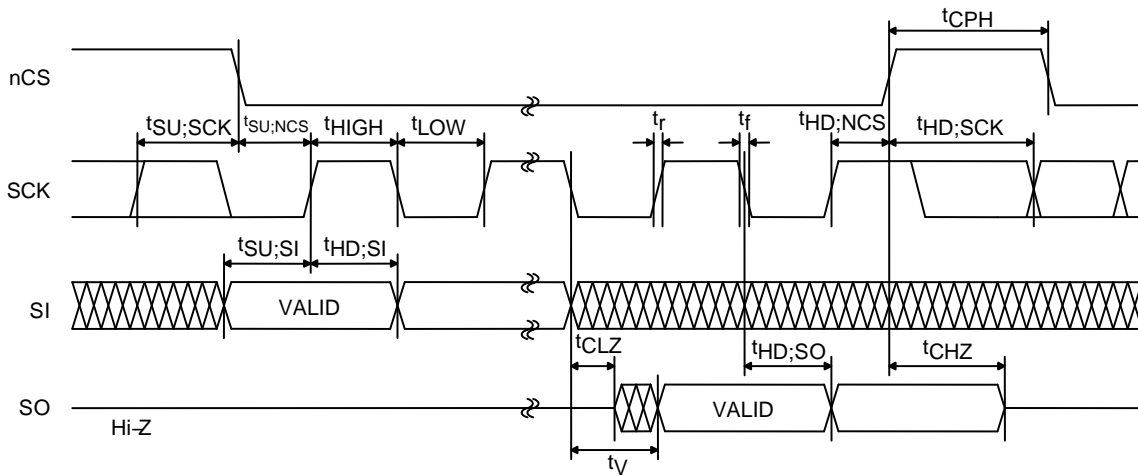

Figure 5.

SPI Communication Formats (Example of Mode 0)

- Write format (data can be written into sequentially incremented addresses while holding nCS = L)

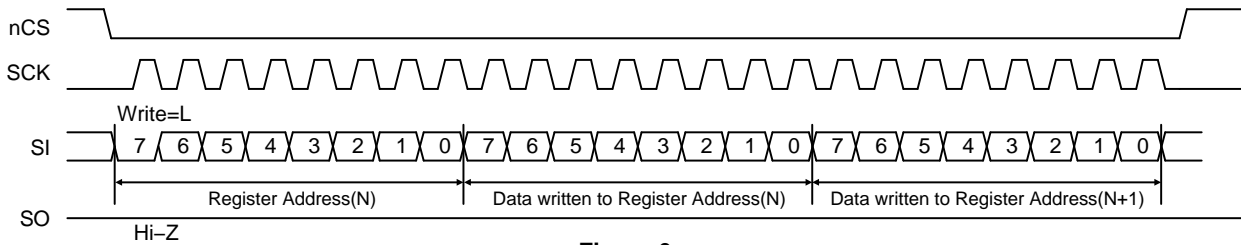

Figure 6.

- Read format (data can be read from sequentially incremented addresses while holding nCS = L)

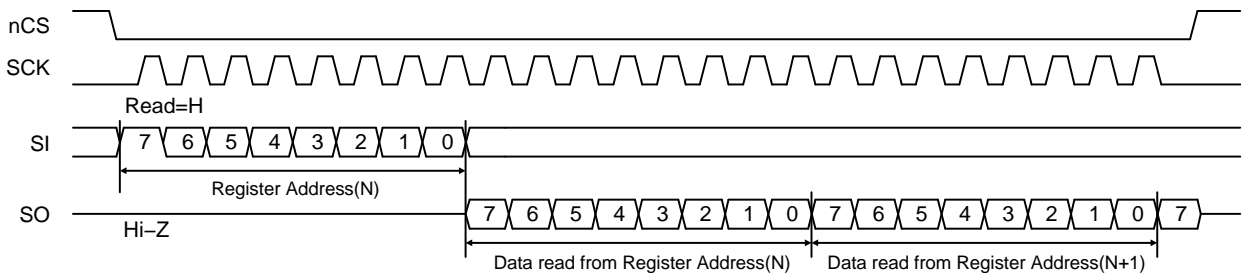

Figure 7.

LC717A00AR

Block Diagram

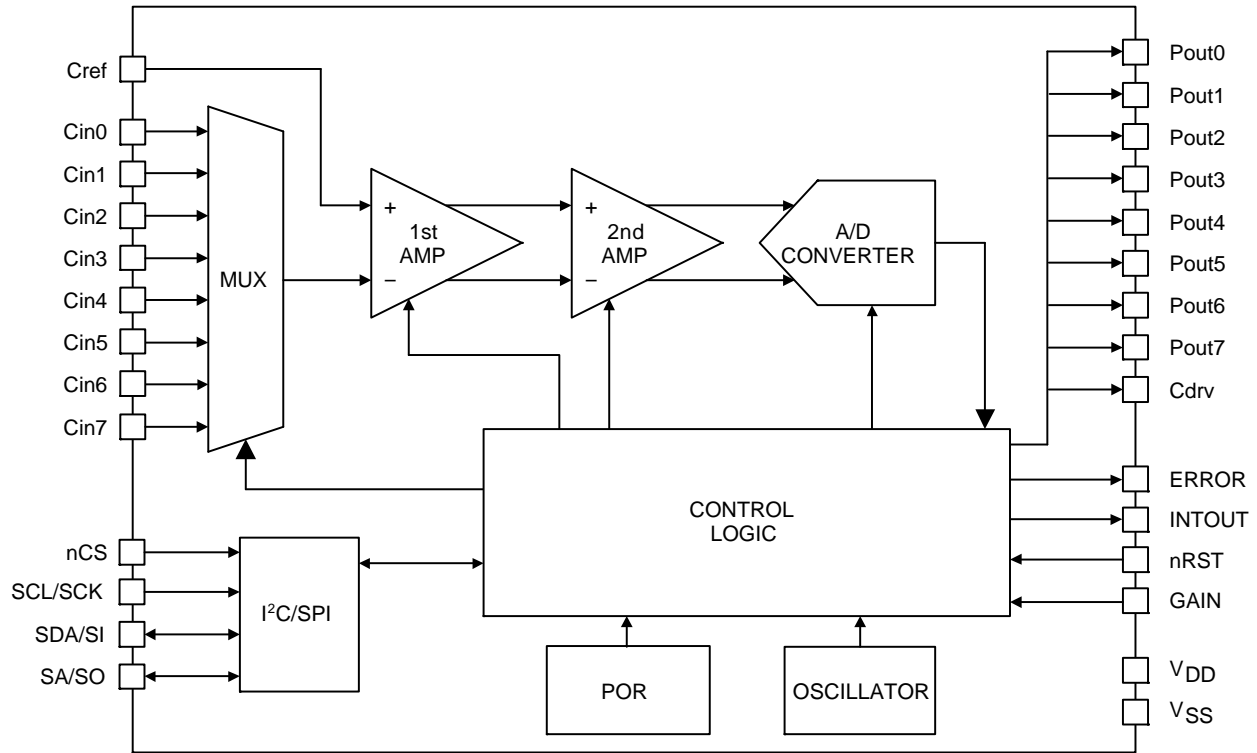

Figure 8. Block Diagram

LC717A00AR is capacitance-digital-converter LSI capable of detecting changes in capacitance in the femto Farad order. It consists of an oscillation circuit that generates the system clock, a power-on reset circuit that resets the system when the power is turned on, a multiplexer that selects the input channels, a two-stage amplifier that detects

the changes in the capacitance and outputs analog-amplitude values, a A/D converter that converts the analog-amplitude values into digital data, and a control logic that controls the entire chip. Also, it has an I²C compatible bus or SPI that enables serial communication with external devices as necessary.

LC717A00AR

Pin Assignment

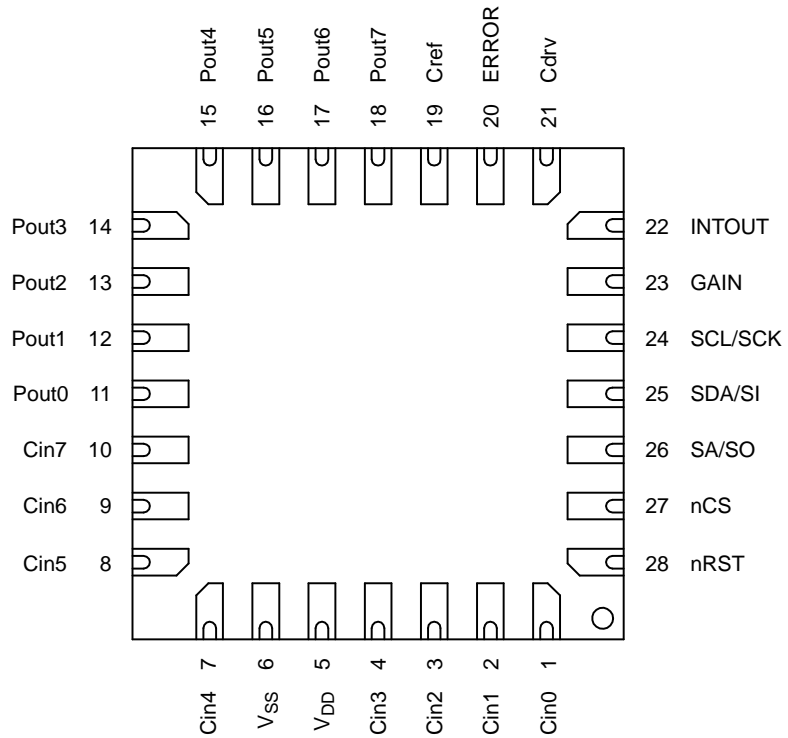

Figure 9. Pin Assignment

Table 7. PIN ASSIGNMENT

Pin No.	Pin Name	Pin No.	Pin Name
1	Cin0	15	Pout4
2	Cin1	16	Pout5
3	Cin2	17	Pout6
4	Cin3	18	Pout7
5	V _{DD}	19	Cref
6	V _{SS}	20	ERROR
7	Cin4	21	Cdrv
8	Cin5	22	INTOUT
9	Cin6	23	GAIN
10	Cin7	24	SCL/SCK
11	Pout0	25	SDA/SI
12	Pout1	26	SA/SO
13	Pout2	27	nCS
14	Pout3	28	nRST

LC717A00AR

Table 8. PIN FUNCTION

Pin Name	I/O	Pin Functions	Pin Type
Cin0	I/O	Capacitance sensor input	
Cin1	I/O	Capacitance sensor input	
Cin2	I/O	Capacitance sensor input	
Cin3	I/O	Capacitance sensor input	
Cin4	I/O	Capacitance sensor input	
Cin5	I/O	Capacitance sensor input	
Cin6	I/O	Capacitance sensor input	
Cin7	I/O	Capacitance sensor input	
Cref	I/O	Reference capacitance input	
Pout0	O	Cin0 judgment result output	
Pout1	O	Cin1 judgment result output	
Pout2	O	Cin2 judgment result output	
Pout3	O	Cin3 judgment result output	
Pout4	O	Cin4 judgment result output	
Pout5	O	Cin5 judgment result output	
Pout6	O	Cin6 judgment result output	
Pout7	O	Cin7 judgment result output	
ERROR	O	Error occurrence status output	
Cdrv	O	Output for capacitance sensors drive	
INTOUT	O	Interrupt output	
SCL/SCK	I	Clock input (I ² C) / Clock input (SPI)	
GAIN	I	Selection pin of the initial value of gain of the 2nd-amplifier	
nCS	I	Interface selection / Chip select inverting input (SPI)	
nRST	I	External reset signal inverting input	
SDA/SI	I/O	Data input and output (I ² C) / Data input (SPI)	

Table 8. PIN FUNCTION (continued)

Pin Name	I/O	Pin Functions	Pin Type
SA/SO	I/O	Slave address selection (I ² C) / Data output (SPI)	
V _{DD}		Power supply (2.6 V to 5.5 V) (Note 13)	
V _{SS}		Ground (Earth) (Notes 13, 14)	

13. Inserting a high-valued capacitor and a low-valued capacitor in parallel between V_{DD} and V_{SS} is recommended. In this case, the small-valued capacitor should be at least 0.1 μF, and is mounted near the LSI.

14. When V_{SS} terminal is not grounded in battery-powered mobile equipment, detection sensitivity may be degraded.

Details of Pin Functions

Cin0 to Cin7

These are the capacitance-sensor-input pins. These pins are used by connecting them to the touch switch pattern. Cin and the Cdrv wire patterns should be close to each other. By doing so, Cdrv and Cin patterns are capacitively coupled. Therefore, LSI can detect capacitance change near each pattern as 8-bit digital data.

However, if the shape of each pattern or the capacitively coupled value of Cdrv is not appropriate, it may not be able to detect the capacitance change correctly.

In this LSI, there is a two-stage amplifier that detects the changes in the capacitance and outputs analog-amplitude values. Cin0 to Cin7 are connected to the inverting input of the 1st amplifier in the LSI.

During measurement process, channels other than the one being measured are all in “Low” condition.

Leave the unused terminals open.

Cref

It is the reference-capacitance-input pin. It is used by connecting to the wire pattern like Cin pins or is used by connecting any capacitance between this pin and Cdrv pin.

In this LSI, there is a two-stage amplifier that detects the changes in the capacitance and outputs analog-amplitude values. Cref is connected to the non-inverting input of the 1st amplifier in the LSI.

Due to the parasitic capacitance generated in the wire connections of Cin pins and their patterns, as well as the one generated between the wire patterns of Cin and Cdrv pins, Cref may not detect capacitance change of each Cin pin accurately. In this case, connect an appropriate capacitance between Cref and Cdrv to detect capacitance change accurately.

However, if the difference between the parasitic capacitance of each Cin pin is extremely large, it may not detect capacitance change in each Cin pin correctly.

Pout0 to Pout7

These are the detection-result-output pins. The capacitance detection results of Cin0 to Cin7 are compared with the threshold of the LSI. The pin outputs a “High” or a “Low” depending on the result.

ERROR

It is the error-occurrence-status-output pin. It outputs “Low” during normal operation. If there is a calibration error or a system error, it outputs “High” to indicate that an error occurred.

Cdrv

It is the output pin for capacitance sensors drive. It outputs the pulse voltage which is needed to detect capacitance at Cin0 to Cin7.

Cdrv and Cin wire patterns should be close to each other so that they are capacitively coupled.

INTOUT

It is the interrupt-output pin. It outputs “High” when a measurement process is completed.

Connect to a main microcomputer if necessary, and use as interrupt signal.

Leave the terminal open if not in used.

SCL/SCK

Clock input (I²C)/Clock input (SPI). It is the clock input pin of the I²C compatible bus or the SPI depending on the mode of operation.

If interface is not to be used, fix the pin to “High”. However, even if interface is not to be used, providing a communication terminal on board is still recommended.

LC717A00AR

GAIN

In this LSI, there is a two-stage amplifier that detects the changes in the capacitance and outputs analog-amplitude values. It is the selection pin of the initial value of gain of the 2nd amplifier.

Even if this LSI is used alone, gain setting can still be selected through this terminal. At initialization of the LSI, it is set to 7-times higher than the minimum setting when GAIN pin is “Low”, and is set to 14-times higher than the minimum setting when GAIN pin is “High”.

nCS

Interface selection/Chip-select-inverting input (SPI). Selection of I²C compatible bus mode or SPI mode is through this terminal. After initialization, the LSI is automatically in I²C compatible bus mode. To continually use I²C compatible bus mode, fix nCS pin to “High”. To switch to SPI mode after LSI initialization, change the nCS input “High” → “Low”. The nCS pin is used as the chip-select-inverting input pin of SPI, and SPI mode is kept until LSI is again initialized.

If interface is not to be used, fix the pin to “High”.

nRST

It is the external-reset-signal-inverting-input pin. When nRST pin is “Low”, LSI is in the reset state.

Each pin (Cin0 to 7, Cref, Pout0 to 7, ERROR) is “Hi-Z” during reset state.

SDA/SI

Data input and output (I²C)/Data input (SPI). It is the data input and output pin of the I²C compatible bus or the data input pin of the SPI depending on the mode of operation.

If interface is not to be used, fix the pin to “High”. However, even if interface is not to be used, providing a communication terminal on board is still recommended.

SA/SO

Slave address selection (I²C)/Data output (SPI). It is the slave address selection pin of the I²C compatible bus or the data output pin of the SPI depending on the mode of operation.

If interface is not to be used, fix the pin to “High”. However, even if interface is not to be used, providing a communication terminal on board is still recommended.

Table 9. ORDERING INFORMATION

Device	Package	Shipping (Qty / Packing) [†]
LC717A00AR-NH	VCT28 3.5 × 3.5 (Pb-Free / Halogen Free)	2000 / Tape & Reel

[†]For information on tape and reel specifications, including part orientation and tape sizes, please refer to our Tape and Reel Packaging Specifications Brochure, [BRD8011/D](#).

MECHANICAL CASE OUTLINE

PACKAGE DIMENSIONS

ON Semiconductor®



VCT28 3.5x3.5
CASE 601AE
ISSUE A

DATE 21 NOV 2013

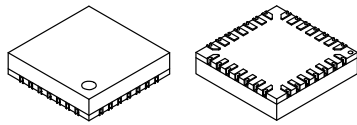

TOP VIEW

SIDE VIEW

BOTTOM VIEW

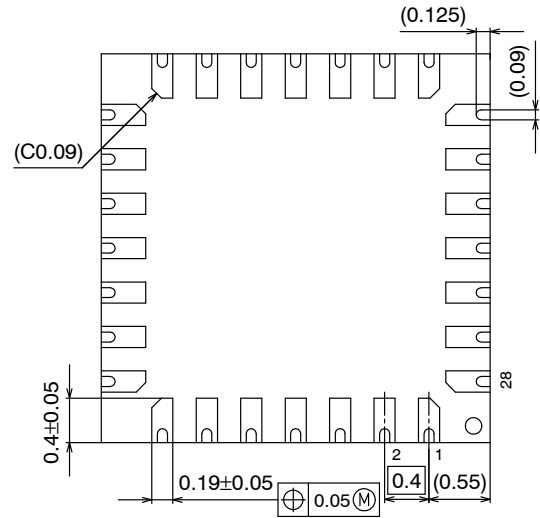
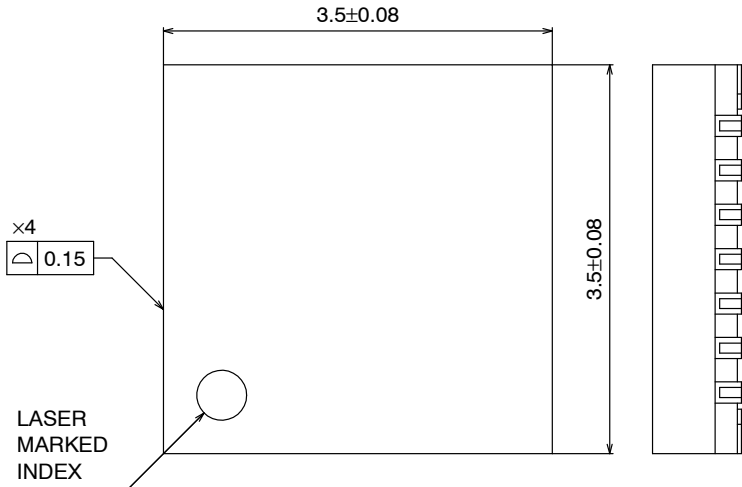

SIDE VIEW

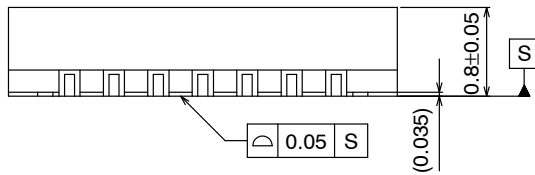

SOLDERING FOOTPRINT*

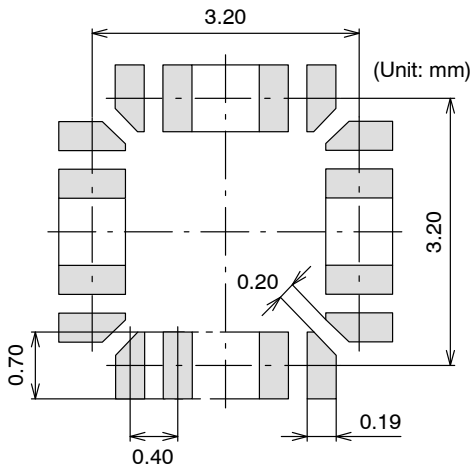

GENERIC MARKING DIAGRAM*

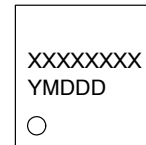

XXXXX = Specific Device Code
Y = Year
M = Month
DDD = Additional Traceability Data

*This information is generic. Please refer to device data sheet for actual part marking. Pb-Free indicator, "G" or microdot "•", may or may not be present.

NOTE: The measurements are not to guarantee but for reference only.

*For additional information on our Pb-Free strategy and soldering details, please download the ON Semiconductor Soldering and Mounting Techniques Reference Manual, SOLDERRM/D.

DOCUMENT NUMBER:	98AON78901E	Electronic versions are uncontrolled except when accessed directly from the Document Repository. Printed versions are uncontrolled except when stamped "CONTROLLED COPY" in red.
DESCRIPTION:	VCT28 3.5X3.5	PAGE 1 OF 1

ON Semiconductor and are trademarks of Semiconductor Components Industries, LLC dba ON Semiconductor or its subsidiaries in the United States and/or other countries. ON Semiconductor reserves the right to make changes without further notice to any products herein. ON Semiconductor makes no warranty, representation or guarantee regarding the suitability of its products for any particular purpose, nor does ON Semiconductor assume any liability arising out of the application or use of any product or circuit, and specifically disclaims any and all liability, including without limitation special, consequential or incidental damages. ON Semiconductor does not convey any license under its patent rights nor the rights of others.

ON Semiconductor and  are trademarks of Semiconductor Components Industries, LLC dba ON Semiconductor or its subsidiaries in the United States and/or other countries. ON Semiconductor owns the rights to a number of patents, trademarks, copyrights, trade secrets, and other intellectual property. A listing of ON Semiconductor's product/patent coverage may be accessed at www.onsemi.com/site/pdf/Patent-Marking.pdf. ON Semiconductor reserves the right to make changes without further notice to any products herein. ON Semiconductor makes no warranty, representation or guarantee regarding the suitability of its products for any particular purpose, nor does ON Semiconductor assume any liability arising out of the application or use of any product or circuit, and specifically disclaims any and all liability, including without limitation special, consequential or incidental damages. Buyer is responsible for its products and applications using ON Semiconductor products, including compliance with all laws, regulations and safety requirements or standards, regardless of any support or applications information provided by ON Semiconductor. "Typical" parameters which may be provided in ON Semiconductor data sheets and/or specifications can and do vary in different applications and actual performance may vary over time. All operating parameters, including "Typicals" must be validated for each customer application by customer's technical experts. ON Semiconductor does not convey any license under its patent rights nor the rights of others. ON Semiconductor products are not designed, intended, or authorized for use as a critical component in life support systems or any FDA Class 3 medical devices or medical devices with a same or similar classification in a foreign jurisdiction or any devices intended for implantation in the human body. Should Buyer purchase or use ON Semiconductor products for any such unintended or unauthorized application, Buyer shall indemnify and hold ON Semiconductor and its officers, employees, subsidiaries, affiliates, and distributors harmless against all claims, costs, damages, and expenses, and reasonable attorney fees arising out of, directly or indirectly, any claim of personal injury or death associated with such unintended or unauthorized use, even if such claim alleges that ON Semiconductor was negligent regarding the design or manufacture of the part. ON Semiconductor is an Equal Opportunity/Affirmative Action Employer. This literature is subject to all applicable copyright laws and is not for resale in any manner.

PUBLICATION ORDERING INFORMATION

LITERATURE FULFILLMENT:

Email Requests to: orderlit@onsemi.com

ON Semiconductor Website: www.onsemi.com

TECHNICAL SUPPORT

North American Technical Support:
Voice Mail: 1 800-282-9855 Toll Free USA/Canada
Phone: 011 421 33 790 2910

Europe, Middle East and Africa Technical Support:

Phone: 00421 33 790 2910

For additional information, please contact your local Sales Representative

Mouser Electronics

Authorized Distributor

Click to View Pricing, Inventory, Delivery & Lifecycle Information:

[onsemi:](#)

[LC717A00ARGEVK](#)