

## DESCRIPTION

The MP20075 precision DDR2/3/3L/4 termination LDO regulator features a precision VREF/2 tracking voltage for accurate termination. The VTT-LDO output can sink/source up to 3A.

The MP20075 maintains a fast transient response only requires 20µF (2x10µF) ceramic output capacitance. The MP20075 supports Kelvin sensing.

The MP20075 is available in the 8-pin MSOP with Exposed PAD and is specified from -40°C to 85°C.

## FEATURES

- VDDQ Voltage Range: 1.05V to 3.6 V
- Up to 3A Integrated Sink/Source Linear Regulator with Accurate VREF/2 Divider Reference for DDR2/3/3L/4 Termination
- Requires Only 20µF Ceramic Output Capacitance
- Drive Voltage: 3.3V
- 1.05V Input (VDDQ) Helps Reduce Total Power Dissipation
- Integrated Divider Tracks VREF for accurate VTT and VTTREF Output Voltage
- Kelvin Sensing (VTTSEN)
- ±30mV Accuracy for VTT
- ±18mV Accuracy for VTTREF
- Built-In Soft-Start, UVLO and OCL
- Thermal Shutdown

## APPLICATIONS

- Notebook DDR2/3/3L/4 Memory Supply and Termination Voltage in ACPI Compliant Systems
- Active Termination Bus

All MPS parts are lead-free and adhere to the RoHS directive. For MPS green status, please visit MPS website under Products, Quality Assurance page.

"MPS" and "The Future of Analog IC Technology" are registered trademarks of Monolithic Power Systems, Inc.

## TYPICAL APPLICATION

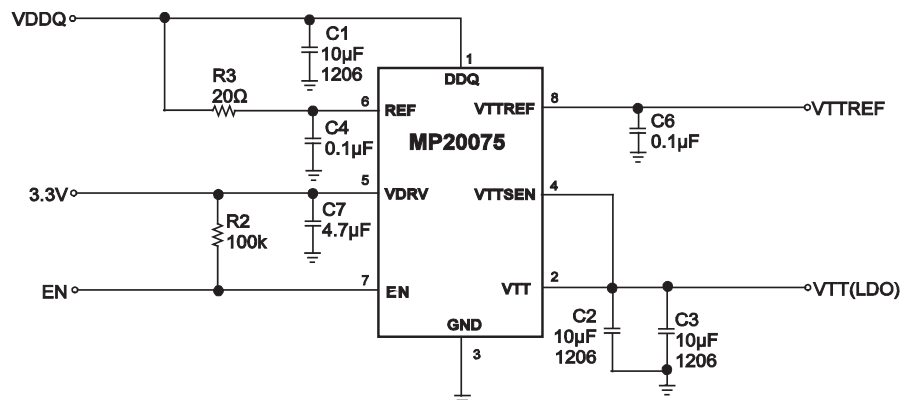

**ORDERING INFORMATION**

Part Number*	Package	Top Marking	Free Air Temperature (T <sub>A</sub> )
MP20075DH	MSOP8E	20075	-40°C to +85°C

\* For Tape & Reel, add suffix –Z (e.g. MP20075DH–Z);  
 For RoHS Compliant Packaging, add suffix –LF (e.g. MP20075DH–LF–Z)

**PACKAGE REFERENCE**

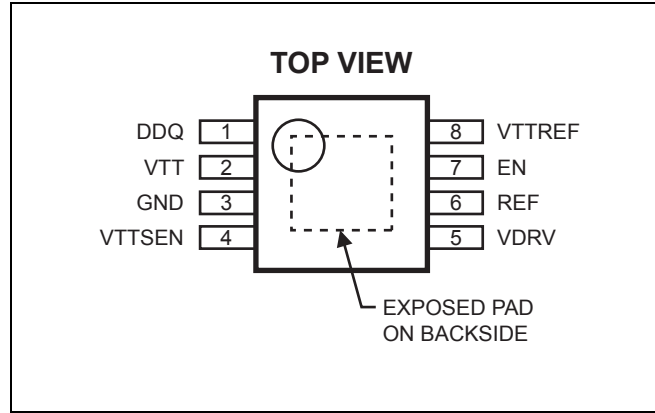

**ABSOLUTE MAXIMUM RATINGS** <sup>(1)</sup>

Supply Voltage V <sub>DDQ</sub> .....	-0.3V to 3.6V
Drive Voltage VDRV.....	-0.3V to 6.0V
All Other Pins.....	-0.3V to 6.0V
Continuous Power Dissipation (T <sub>A</sub> = +25°C) <sup>(2)</sup>	1.56W
Junction Temperature.....	150°C
Lead Temperature .....	260°C
Storage Temperature .....	-50°C to +150°C

**Recommended Operating Conditions** <sup>(3)</sup>

Drive Voltage VDRV.....	3.0V to 3.5V
Operating Junct. Temp (T <sub>J</sub> ) .....	-40°C to +125°C

**Thermal Resistance** <sup>(4)</sup>

	$\theta_{JA}$	$\theta_{JC}$
MSOP8E.....	50.....	12... °C/W

**Notes:**

- Exceeding these ratings may damage the device.
- The maximum allowable power dissipation is a function of the maximum junction temperature T<sub>J</sub>(MAX), the junction-to-ambient thermal resistance  $\theta_{JA}$ , and the ambient temperature T<sub>A</sub>. The maximum allowable continuous power dissipation at any ambient temperature is calculated by P<sub>D</sub>(MAX)=(T<sub>J</sub>(MAX)-T<sub>A</sub>)/  $\theta_{JA}$ . Exceeding the maximum allowable power dissipation will cause excessive die temperature, and the regulator will go into thermal shutdown. Internal thermal shutdown circuitry protects the device from permanent damage.
- The device is not guaranteed to function outside of its operating conditions.
- Measured on JESD51-7 4-layer board.

## ELECTRICAL CHARACTERISTICS

$V_{DRV} = 3.3V$ ,  $T_A = +25^{\circ}C$ , unless otherwise noted.

Parameters	Symbol	Test Condition	Min	Typ	Max	Unit
VDRV Operating Voltage	VDRV	ITT=3A	3.0	3.3	3.5	V
VDRV Shut down current	IDRV_SD	VDRV =3.3 V, VDDQ=0V		0.2	1.0	$\mu A$
VDRV Operation Current	IDRV	VEN_H, VTT=0.75V		1.3	3	mA
Thermal Trip Point	TSD			150		$^{\circ}C$
Hysteresis	TSDHYS			25		$^{\circ}C$
VDDQ UVLO Upper Threshold	VDDQUV+	Rising Edge; hysteresis = 55mV		0.9	1.0	V
VTT with Respect to 1/2VREF	dVTT0	1/2VREF – VTT, VREF = 1.8V, IVTT = 0 to 3A (Sink Current) IVTT = 0 to 3A (Source Current)	-30 -30		30 30	mV
		1/2VREF – VTT, VREF = 1.5V, IVTT = 0 to 3A (Sink Current) IVTT = 0 to 3A (Source Current)	-30 -30		30 30	mV
		1/2VREF -VTT, VREF=1.35V IVTT = 0 to 3A (Sink Current) IVTT = 0 to 3A (Source Current)	-30 -30		30 30	mV
Source Current Limit	ILIMVTSrc			4.0		A
Sink Current Limit	ILIMVTSnk			4.0		A
Soft-Start Source Current Limit	ILIMVTSS			1.0		A
Maximum Soft-Start Time	tssvtmax	VREF=1.8, VDRV=3.3V		9		$\mu s$
		VREF=1.5V, VDRV=3.3V		7		
VTTREF Source Current	IVTTR	VREF = 1.8 V or 1.5 V	10			mA
VTTREF Accuracy Referred to 1/2VREF	dVTTR	1/2VREF – VTTR, VREF = 1.8 V, IVTTR = 0mA to 10mA	-18		18	mV
		1/2VREF – VTTR, VREF = 1.5 V, IVTTR = 0mA to 10mA	-15		15	mV
EN Pin Threshold High	EN_H		1.4			V
EN Pin Threshold Low	EN_L				0.5	V
EN Pin Input Current	IIN_EN	EN = 3.3 V			1.0	$\mu A$

## PIN FUNCTIONS

Pin #	Name	Description
1	DDQ	Power input for VTT regulator. Bypass with a 10 $\mu$ F ceramic capacitor. It is normally connected to the VDDQ of DDR2/3/3L/4 memory rail.
2	VTT	Power output for the VTT LDO. Output is a precision VREF/2 voltage that tracks VREF. Recommended bypass is 2x10 $\mu$ F ceramic capacitors.
3	GND, Exposed Pad	The exposed pad and GND pin must be connected to the same ground plane.
4	VTTSEN	Kelvin sensed feedback signal.
5	VDRV	Chip bias Voltage. Connect to 3.3V supply and bypass with a 4.7 $\mu$ F capacitor.
6	REF	LDO signal input for generating VDDQ/2 reference. Bypass with a 0.1 $\mu$ F capacitor.
7	EN	VTT regulator enable input. EN HIGH will enable the MP20075 requires 100k pull-up resistor.
8	VTTREF	Precision buffered output for the system with a drive capability up to 10mA. The receiving end of the DDR2/3/3L/4 memory cells requires this signal for their input comparator. Bypass with a 0.1 $\mu$ F capacitor.

**TYPICAL PERFORMANCE CHARACTERISTICS**

$C_1 = C_2 = C_3 = 10\mu\text{F}$ ,  $C_4 = C_6 = 0.1\mu\text{F}$ ,  $C_7 = 4.7\mu\text{F}$ ,  $V_{\text{DRV}} = 3.3\text{V}$ ,  $T_A = 25^\circ\text{C}$ , unless otherwise noted.

**$V_{\text{TTREF}}$  Regulation**

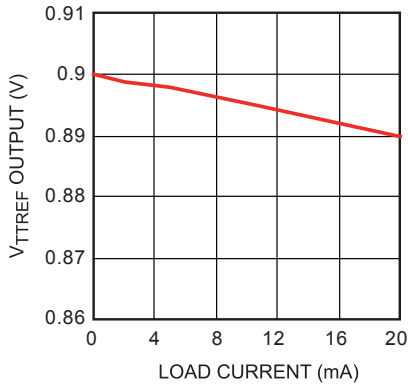

**DDR2 Regulation**

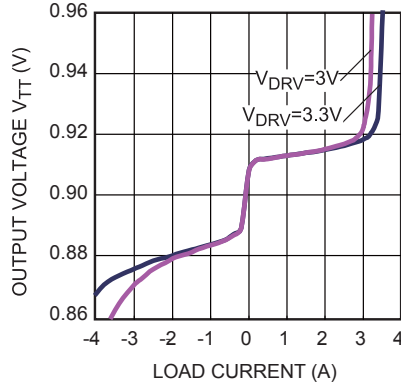

**DDR3 Regulation**

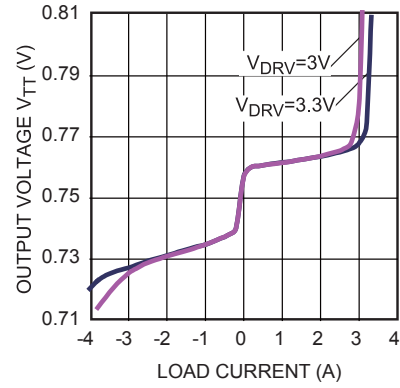

**$I_{\text{DRV}}$  Supply Current vs. Temp**  
 $V_{\text{DDQ}} = V_{\text{REF}} = 1.5\text{V}$ ,  $V_{\text{TT}} = 0.75\text{V}$

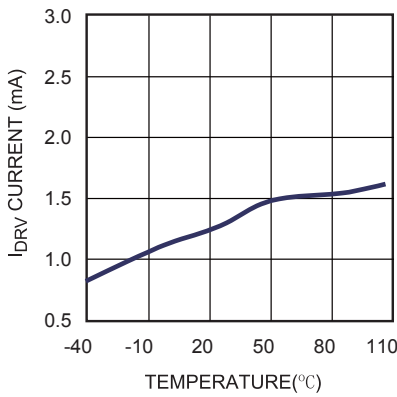

**$V_{\text{TT}}$  Voltage vs. Temp**  
 $V_{\text{DDQ}} = V_{\text{REF}} = 1.8\text{V}$ ,  $V_{\text{TT}} = 0.9\text{V}$

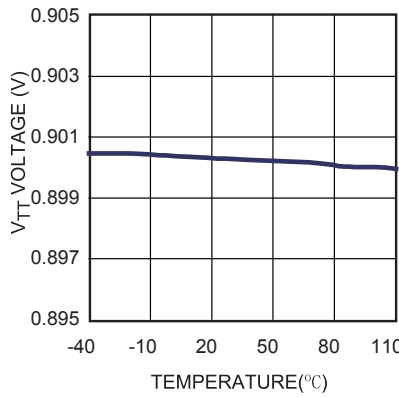

**$V_{\text{TT}}$  Voltage vs. Temp**  
 $V_{\text{DDQ}} = V_{\text{REF}} = 1.5\text{V}$ ,  $V_{\text{TT}} = 0.75\text{V}$

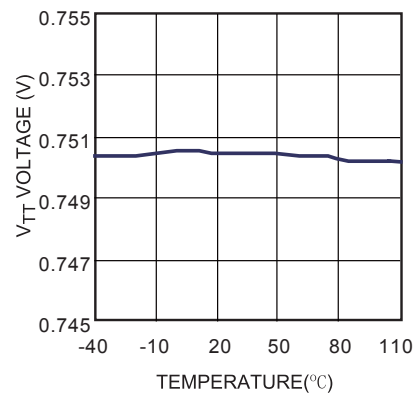

**Source Load Transient**  
 $V_{\text{DDQ}} = V_{\text{REF}} = 1.8\text{V}$ ,  $V_{\text{TT}} = 0.9\text{V}$

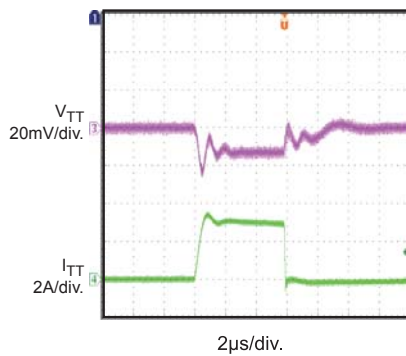

**Sink Load Transient**  
 $V_{\text{DDQ}} = V_{\text{REF}} = 1.8\text{V}$ ,  $V_{\text{TT}} = 0.9\text{V}$

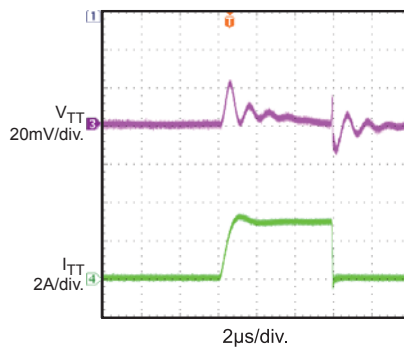

**Source Over Current Protection**  
 $V_{\text{DDQ}} = V_{\text{REF}} = 1.8\text{V}$ ,  $V_{\text{TT}} = 0.9\text{V}$

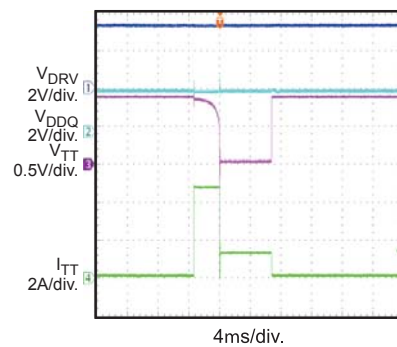

**TYPICAL PERFORMANCE CHARACTERISTICS** *(continued)*

$C_1 = C_2 = C_3 = 10\mu\text{F}$ ,  $C_4 = C_6 = 0.1\mu\text{F}$ ,  $C_7 = 4.7\mu\text{F}$ ,  $V_{\text{DRV}} = 3.3\text{V}$ ,  $T_A = 25^\circ\text{C}$ , unless otherwise noted.

**Power Ramp Up**

$V_{\text{DDQ}} = V_{\text{REF}} = 1.8\text{V}$ ,  $V_{\text{TT}} = 0.9\text{V}$

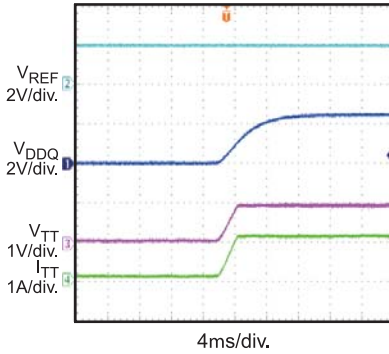

**Power Ramp Down**

$V_{\text{DDQ}} = V_{\text{REF}} = 1.8\text{V}$ ,  $V_{\text{TT}} = 0.9\text{V}$

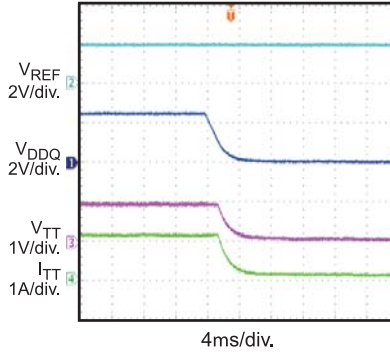

**Sink Over Current Protection**

$V_{\text{DDQ}} = V_{\text{REF}} = 1.8\text{V}$ ,  $V_{\text{TT}} = 0.9\text{V}$

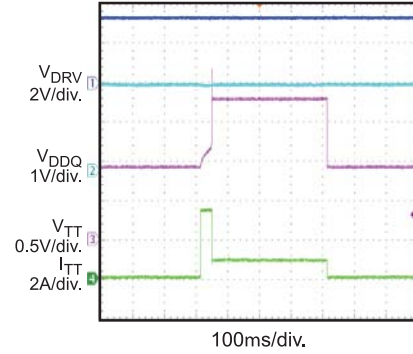

**Enable On**

$V_{\text{DDQ}} = V_{\text{REF}} = 1.8\text{V}$ ,  $V_{\text{TT}} = 0.9\text{V}$

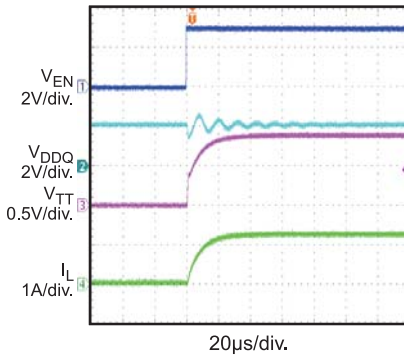

**Enable Off**

$V_{\text{DDQ}} = V_{\text{REF}} = 1.8\text{V}$ ,  $V_{\text{TT}} = 0.9\text{V}$

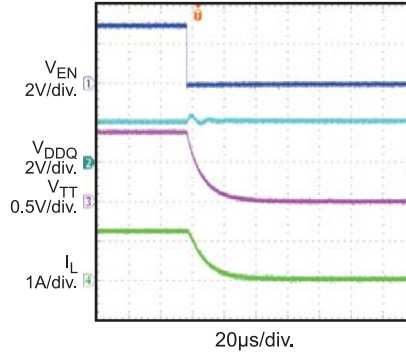

**Short Circuit**

$V_{\text{DDQ}} = V_{\text{REF}} = 1.8\text{V}$ ,  $V_{\text{TT}} = 0.9\text{V}$

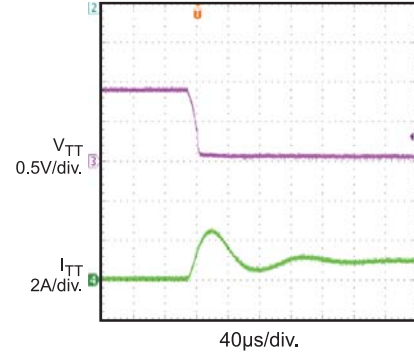

**Short Circuit Recovery**

$V_{\text{DDQ}} = V_{\text{REF}} = 1.8\text{V}$ ,  $V_{\text{TT}} = 0.9\text{V}$

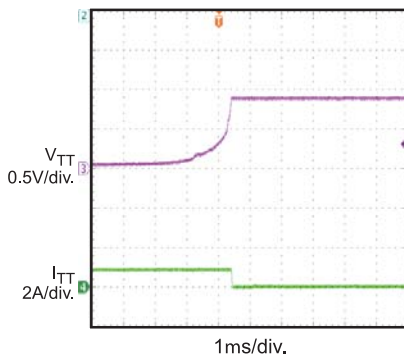

## DETAILED OPERATING DESCRIPTION

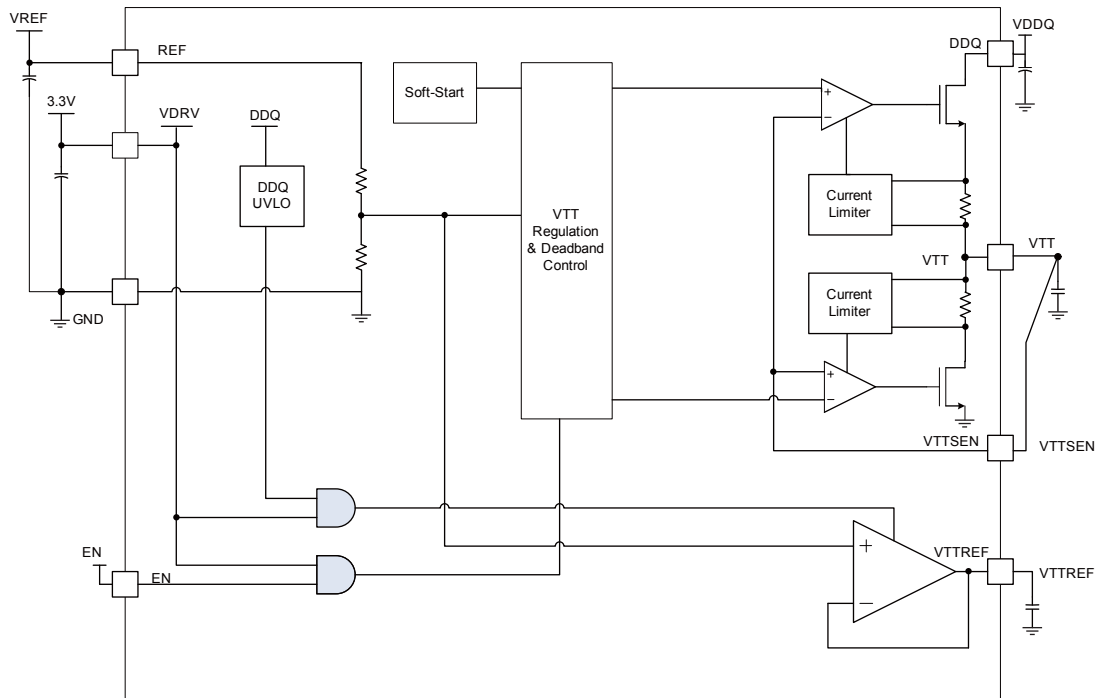

**Figure 1—Function Block Diagram**

### Control Logic

The internal control logic is powered by VDRV. The IC is enabled whenever VDDQ UVLO is pulled low. VTTREF output begins to track VREF/2. When the VTTEN pin is high, the VTT regulator is activated.

### VTTREF Output

The VTTREF output tracks VREF/2 with  $\pm 2\%$  accuracy. It has source current capability of up to 10mA. VTTREF should be bypassed to analog ground with a 1.0 $\mu$ F ceramic capacitor for stable operation.

The VTTREF is turned on as long as VDDQ is higher the UVLO threshold. VTTREF features a soft-start and tracks VREF/2.

### Output Voltages Sensing

The VTT output voltage is sensed across the VTTSEN and GND pins. The VTTSEN should be connected to the VTT regulation point, which is usually the VTT local bypass capacitor, via a direct sense trace. The GND should be connected via a direct sense trace to the ground of the VTT local bypass capacitor for load.

### VDDQ UVLO Protection

For VDDQ under-voltage lockout (UVLO) protection, the MP20075 monitors VDDQ voltage. When the VDDQ voltage is lower than UVLO threshold voltage, the VTT regulator is shut off.

### Current Protection of VTT Active Terminator

To provide protection for the internal FETs, over current limit (OCL) of 4A is implemented.

The LDO has a constant overcurrent limit (OCL) at 4A. This trip point is reduced to 1.0A if the output voltage drops below 1/3 of the target voltage.

### Thermal Consideration of VTT Active Terminator

The VTT terminator is designed to handle large transient output currents. If large currents are required for very long duration, then care should be taken to ensure the maximum junction temperature is not exceeded. The 8-pin MSOP with Exposed PAD has a thermal resistance of 50°C/W (dependent on air flow, and PCB design).

In order to take full advantage of the thermal capability of this package, the exposed pad should be soldered directly onto the PCB ground layer to allow good thermal contact. It is recommended that the PCB should have 10 to 15 vias with 0.3mm drill size underneath the exposed thermal pad connecting all the ground layers

**Supply Voltage Undervoltage Monitor**

The IC continuously monitors VDDQ. If VDDQ is set higher than its preset threshold and VTEN is high too, the IC will start up.

**Thermal Shutdown**

When the chip junction temperature exceeds 150°C, the entire IC is shutdown. The IC resumes normal operation only after the junction temperature dropping below 125°C.



## APPLICATION INFORMATION

### Input Capacitor

Depending on the trace impedance from the power supply to the part, transient increase of source current is supplied mostly by the charge from the VDDQ input capacitor. Use a 10 $\mu$ F (or more) ceramic capacitor to supply this transient charge. Provide more input capacitance as more output capacitance is used at VTT. In general, use 1/2 COUT for input.

### Output Capacitor

For stable operation, total capacitance of the VTT output terminal can be equal or greater than 20 $\mu$ F. Attach two 10 $\mu$ F ceramic capacitors in parallel to minimize the effect of ESR and ESL. If the ESR is greater than 10m $\Omega$ , insert an R-C filter between the output and the VTTSEN input to achieve loop stability. The R-C filter time constant should be almost the same or slightly lower than the time constant of the output capacitor and its ESR.

### VDRV Capacitor

Add a ceramic capacitor with a value between 1.0 $\mu$ F and 4.7 $\mu$ F placed close to the VDRV pin, to stabilize 3.3V from any parasitic impedance from the supply.

### Thermal design

As the MP20075 is a linear regulator, the VTT current flow in both source and sink directions generate power dissipation from the device.

In the source phase, the potential difference between VDDQ and VTT times VTT current becomes the power dissipation,  $P_{source}=(VDDQ-VTT) \times I_{source}$

In this case, if VDDQ is connected to an alternative power supply lower than VDDQ voltage, power loss can be decreased.

For the sink phase, VTT voltage is applied across the internal LDO regulator, and the power dissipation  $P_{sink}$  is:

$$P_{sink}=VTT \times I_{sink}$$

The device does not sink and source the current at the same time and source/sink current varies rapidly with time. The actual power dissipation to be considered for thermal design is an average of the above values over time.

Another power consumption is the current used for internal control circuitry from VDDQ supply. This power needs to be effectively dissipated from the package.

### PCB Layout Guidelines

Good PCB layout design is critical to ensure high performance and stable operation of the DDR2/3/3L/4 power controller. The following items must be considered when preparing PCB layout:

1. All high-current traces must be kept as short and wide as possible to reduce power loss.

High-current traces are the trace from the input voltage terminal to VDDQ pin, the trace from the VTT output terminal to the load, the trace from the input ground terminal to the VTT output ground terminal, and the trace from VTT output ground terminal to the GND pin.

Power handling and heatsinking of high-current traces can be improved by also routing the same high-current traces in the other layers by the same path and joining them together with multiple vias.

2. To ensure the proper function of the device, separated ground connections should be used for different parts of the application circuit according to their functions.

The VTT output capacitor ground should be connected to the GND pin first with a short trace, it is then connected to the ground plane of GND. The input capacitor ground, the VTT output capacitor ground, the VDDQ decoupling capacitor ground should be connected to the GND plane.

3. The thermal pad of the 8-pin MSOP package should to be connected to GND for better thermal performance. It is recommended to use a PCB with 1 oz or 2oz copper foil.

4. A separate sense trace should be used to connect the VTT point of regulation, which is usually the local bypass capacitor for load, to the VTTSEN pin.

5. Separate sense trace should be used to connect the VREF point of regulation to the VTTREF pin to ensure the accuracy of the

reference voltage to VTT.

6. VDDQ should be connected to VREF Input with wide and short trace if VDDQ is used as the sourcing supply for VTT. An input capacitor of at least 10 $\mu$ F should be added close to the VDDQ pin and bypassed to GND if external voltage supply is used as the VTT sourcing supply.

**PACKAGE INFORMATION**

**MSOP8E (EXPOSED PAD)**

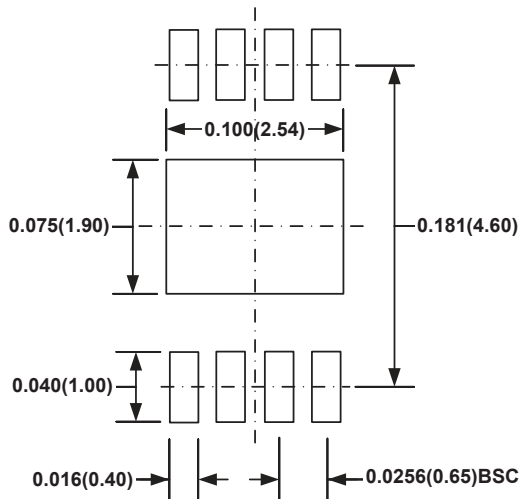
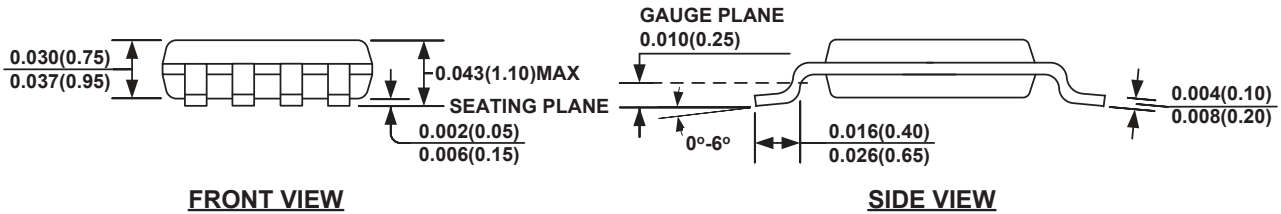
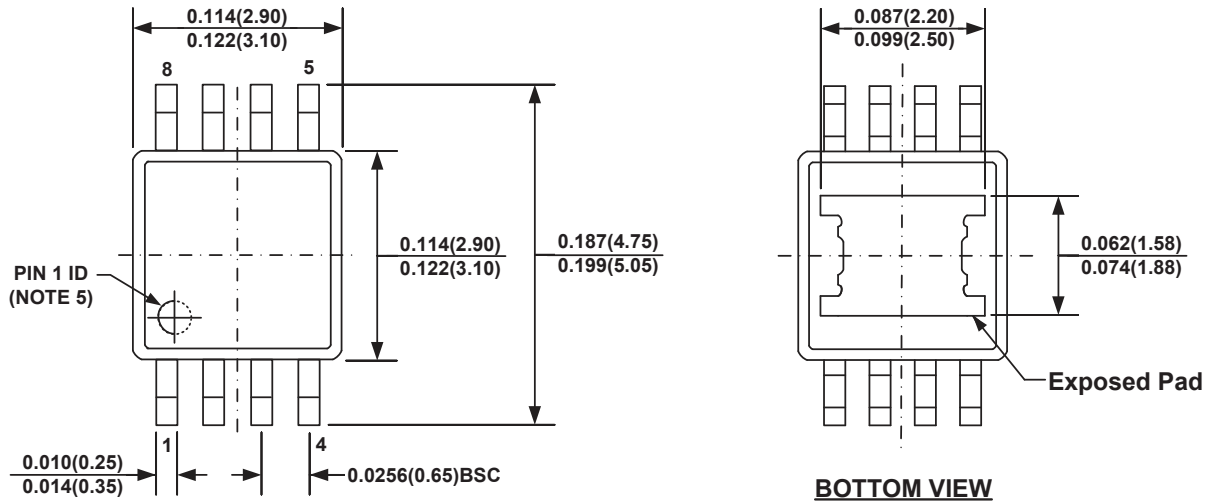

**NOTE:**

- 1) CONTROL DIMENSION IS IN INCHES. DIMENSION IN BRACKET IS IN MILLIMETERS.
- 2) PACKAGE LENGTH DOES NOT INCLUDE MOLD FLASH, PROTRUSION OR GATE BURR.
- 3) PACKAGE WIDTH DOES NOT INCLUDE INTERLEAD FLASH OR PROTRUSION.
- 4) LEAD COPLANARITY (BOTTOM OF LEADS AFTER FORMING) SHALL BE 0.004" INCHES MAX.
- 5) PIN 1 IDENTIFICATION HAS HALF OR FULL CIRCLE OPTION.
- 6) DRAWING MEETS JEDEC MO-187, VARIATION AA-T.
- 7) DRAWING IS NOT TO SCALE.

**NOTICE:** The information in this document is subject to change without notice. Users should warrant and guarantee that third party Intellectual Property rights are not infringed upon when integrating MPS products into any application. MPS will not assume any legal responsibility for any said applications.

# Mouser Electronics

Authorized Distributor

Click to View Pricing, Inventory, Delivery & Lifecycle Information:

[Monolithic Power Systems \(MPS\):](#)

[MP20075DH-LF-P](#) [MP20075DH-LF-Z](#)