

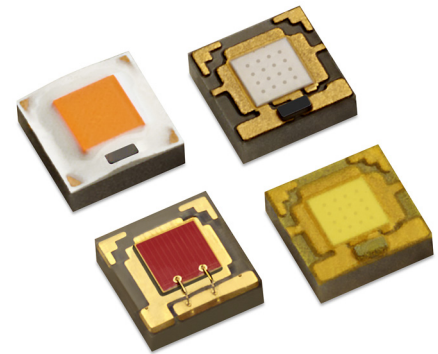

LUXEON CZ Color Line

Maximum punch in any application

LUXEON CZ Color Line is an optically advanced portfolio of Color and White LEDs. Designed to maximize punch, the LUXEON CZ Color Line is the optimal LED solution for architecture, entertainment and emergency vehicle lighting applications.



FEATURES AND BENEFITS

- Small and symmetrical 2x2mm² package
- Industry leading Hot/Cold Factors and the lowest thermal resistance
- Maximized punch (cd/lm)

PRIMARY APPLICATIONS

- Architectural & Entertainment
- Lamps
 - Color Tunable
- Specialty Lighting
 - Emergency Vehicle

Table of Contents

General Product Information	2
Product Test Conditions	2
Part Number Nomenclature	2
Lumen Maintenance	2
Environmental Compliance	2
Performance Characteristics	3
Product Selection Guide	3
Optical Characteristics	4
Electrical and Thermal Characteristics	4
Absolute Maximum Ratings	5
Characteristic Curves	6
Spectral Power Distribution Characteristics	6
Light Output Characteristics	7
Forward Current Characteristics	13
Radiation Pattern Characteristics	16
Product Bin and Labeling Definitions	17
Decoding Product Bin Labeling	17
Luminous Flux Bins	18
Radiometric Power Bins	18
Color Bin Definitions	19
Dominant Wavelength Bins	20
Peak Wavelength Bins	20
Color Bin Structure	21
Forward Voltage Bins	22
Mechanical Dimensions	22
Reflow Soldering Guidelines	23
JEDEC Moisture Sensitivity	23
Solder Pad Design	24
Packaging Information	24
Pocket Tape Dimensions	24
Reel Dimensions	25

General Product Information

Product Test Conditions

LUXEON CZ LEDs are tested and binned with a DC drive current of 350mA at a junction temperature, T_j , of 85°C.

Part Number Nomenclature

Part numbers for LUXEON CZ Colors follow the convention below:

L 1 C U – **A A A** 1 0 0 0 0 0 0 0 0 0

Where:

A A A – designates color (RED=Red, RNG=Red-Orange, AMB=Amber, PCA=PC Amber, MNT=Mint, GRN=Green, CYN=Cyan, BLU=Blue, RYL=Royal Blue)

Therefore, the following part number is used for a LUXEON CZ Red:

L 1 C U – **R E D** 1 0 0 0 0 0 0 0 0 0

Part numbers for LUXEON CZ White follow the convention below:

L 1 C U – **A A B B** 0 0 0 0 0 0 0 0 0 0

Where:

A A – designates nominal CCT (30=3000K, 40=4000K, 50=5000K, 57=5700K)

B B – designates minimum CRI (70=70CRI, 80=80CRI)

Therefore, the following part number is used for LUXEON CZ White at 5700K 70CRI:

L 1 C U – **5 7 7 0** 0 0 0 0 0 0 0 0 0 0

Lumen Maintenance

Please contact your local Sales Representative or Lumileds Technical Solutions Manager for more information about the long-term performance of this product.

Environmental Compliance

Lumileds LLC is committed to providing environmentally friendly products to the solid-state lighting market. LUXEON CZ is compliant to the European Union directives on the restriction of hazardous substances in electronic equipment, namely the RoHS Directive 2011/65/EU and REACH Regulation (EC) 1907/2006. Lumileds LLC will not intentionally add the following restricted materials to its products: lead, mercury, cadmium, hexavalent chromium, polybrominated biphenyls (PBB) or polybrominated diphenyl ethers (PBDE).

Performance Characteristics

Product Selection Guide

Table 1a. Product performance of LUXEON CZ Colors at 350mA, T_j=85°C.

COLOR	DOMINANT OR PEAK WAVELENGTH RANGE ^[1] (nm)		LUMINOUS FLUX (lm) OR RADIOMETRIC POWER ^[2] (mW)		PART NUMBER
	MINIMUM	MAXIMUM	MINIMUM	TYPICAL	
Red	624	634	20	31	L1CU-RED1000000000
Red-Orange	614	624	30	37	L1CU-RNG1000000000
Amber	585	600	10	15	L1CU-AMB1000000000
PC Amber	-	-	65	78	L1CU-PCA1000000000
Mint	-	-	120	132	L1CU-MNT1000000000
Green	520	540	80	99	L1CU-GRN1000000000
Cyan	490	510	60	73	L1CU-CYN1000000000
Blue	465	485	25	33	L1CU-BLU1000000000
Royal Blue	440	460	400	425	L1CU-RYL1000000000

Notes for Table 1a:

- Lumileds maintains a tolerance of ±6.5% on luminous flux measurements. PC Amber is binned by chromaticity coordinates. Royal Blue is binned by peak wavelength. All other colors are binned by dominant wavelength.
- Royal Blue is binned by radiometric power. All other colors are binned by luminous flux.

Table 1b. Product performance of LUXEON CZ White at 350mA, T_j=85°C.

NOMINAL CCT	MINIMUM CRI	LUMINOUS FLUX (lm)		TYPICAL LUMINOUS EFFICACY (lm/W)	PART NUMBER
		MINIMUM	TYPICAL		
4000K	70	100	109	113	L1CU-4070000000000
5000K	70	100	109	113	L1CU-5070000000000
5700K	70	100	110	113	L1CU-5770000000000
3000K	80	90	95	99	L1CU-3080000000000

Notes for Table 1b:

- Lumileds maintains a tolerance of ±6.5% on luminous flux and ±2 on CRI measurements for these products.

Optical Characteristics

Table 2a. Optical characteristics for LUXEON CZ Colors at 350mA, T_j=85°C.

COLOR	PART NUMBER	TYPICAL SPECTRAL HALF-WIDTH ^[1] (nm)	TYPICAL TOTAL INCLUDED ANGLE ^[2] (degrees)	TYPICAL TEMPERATURE COEFFICIENT OF DOMINANT OR PEAK WAVELENGTH (nm/°C)	TYPICAL VIEWING ANGLE ^[3] (degrees)
Red	L1CU-RED1000000000	20	140°	0.06	120°
Red-Orange	L1CU-RNG1000000000	20	140°	0.06	120°
Amber	L1CU-AMB1000000000	20	140°	0.06	120°
PC Amber	L1CU-PCA1000000000	80	140°	-0.01	120°
Mint	L1CU-MNT1000000000	80	140°	0.03	120°
Green	L1CU-GRN1000000000	35	140°	0.04	120°
Cyan	L1CU-CYN1000000000	20	140°	0.03	120°
Blue	L1CU-BLU1000000000	25	140°	0.03	120°
Royal Blue	L1CU-RYL1000000000	20	140°	0.03	120°

Notes for Table 2a:

1. Spectral half-width is the spectral bandwidth at 50% of the peak intensity.
2. Total angle at which 90% of total luminous flux is captured.
3. Viewing angle is the off axis angle from the LED centerline where the luminous intensity is ½ of the peak value.

Table 2b. Optical characteristics for LUXEON CZ White at 350mA, T_j=85°C.

PART NUMBER	TYPICAL TOTAL INCLUDED ANGLE ^[2]	TYPICAL VIEWING ANGLE ^[3]
L1CU-xxx0000000000	140°	120°

Notes for Table 2b:

1. Spectral half-width is the spectral bandwidth at 50% of the peak intensity.
2. Total angle at which 90% of total luminous flux is captured.
3. Viewing angle is the off axis angle from the LED centerline where the luminous intensity is ½ of the peak value.

Electrical and Thermal Characteristics

Table 3. Electrical and thermal characteristics for LUXEON CZ Color Line at 350mA, T_j=85°C.

COLOR	PART NUMBER	FORWARD VOLTAGE ^[1] (V _f)			TYPICAL TEMPERATURE COEFFICIENT OF FORWARD VOLTAGE ^[2] (mV/°C)	TYPICAL THERMAL RESISTANCE—JUNCTION TO SOLDER PAD (°C/W)
		MINIMUM	TYPICAL	MAXIMUM		
Red	L1CU-RED1000000000	1.75	2.00	2.50	-1.6	3.5
Red-Orange	L1CU-RNG1000000000	1.75	2.05	2.50	-1.6	3.5
Amber	L1CU-AMB1000000000	1.75	2.05	2.50	-2.0	3.5
PC Amber	L1CU-PCA1000000000	2.50	2.75	3.50	-1.7	3.5
Mint	L1CU-MNT1000000000	2.50	2.75	3.50	-2.7	3.2
Green	L1CU-GRN1000000000	2.50	3.05	3.50	-2.4	4.0
Cyan	L1CU-CYN1000000000	2.50	3.05	3.50	-2.4	4.0
Blue	L1CU-BLU1000000000	2.50	2.83	3.50	-2.6	4.0
Royal Blue	L1CU-RYL0000000000	2.50	2.75	3.50	-1.7	3.2
White	L1CU-5770000000000	2.50	2.75	3.50	-1.7	3.2

Notes for Table 3:

1. Lumileds maintains a tolerance of ±0.06V on forward voltage measurements.
2. Measured between 25°C and 85°C.

Absolute Maximum Ratings

Table 4. Absolute maximum ratings for LUXEON CZ Color Line.

PARAMETER	RED, RED-ORANGE, AMBER AND PC AMBER	GREEN, CYAN, BLUE AND ROYAL BLUE	MINT AND WHITE
DC Forward Current ^[1,2]	1050mA	1050mA	1225mA
Peak Pulsed Forward Current ^[1,3]	1300mA	1300mA	1500mA
LED Junction Temperature ^[1] (DC & Pulse)	120°C	135°C	135°C
ESD Sensitivity (ANSI/ESDA/JEDEC JS-001-2012)	Class 3B	Class 3B	Class 3B
LED Storage Temperature	-40°C to 135°C		
Soldering Temperature	JEDEC 020c 260°C		
Allowable Reflow Cycles	3		
Reverse Voltage ($V_{reverse}$)	LUXEON C LEDs are not designed to be driven in reverse bias		

Notes for Table 4:

1. Proper current derating must be observed to maintain the junction temperature below the maximum allowable junction temperature.
2. Residual periodic variations due to power conversion from alternating current (AC) to direct current (DC), also called "ripple," are acceptable if the following conditions are met:
 - The frequency of the ripple current is 100Hz or higher
 - The average current for each cycle does not exceed the maximum allowable DC forward current
 - The maximum amplitude of the ripple does not exceed the maximum peak pulsed forward current
3. At 10% duty cycle with pulse width of 10ms.

Characteristic Curves

Spectral Power Distribution Characteristics

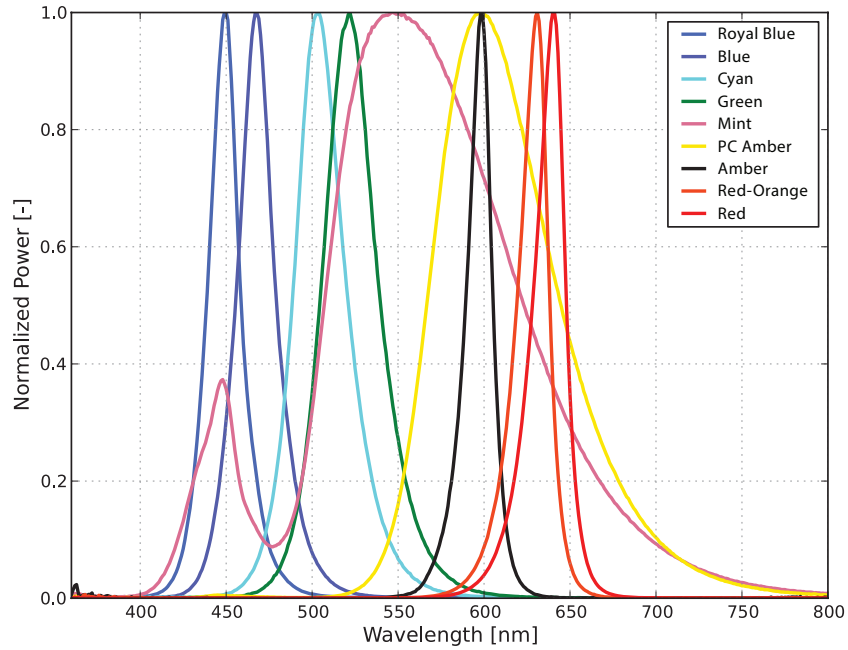

Figure 1a. Typical normalized power vs. wavelength for LUXEON CZ Colors at 350mA, $T_j=85^\circ\text{C}$.

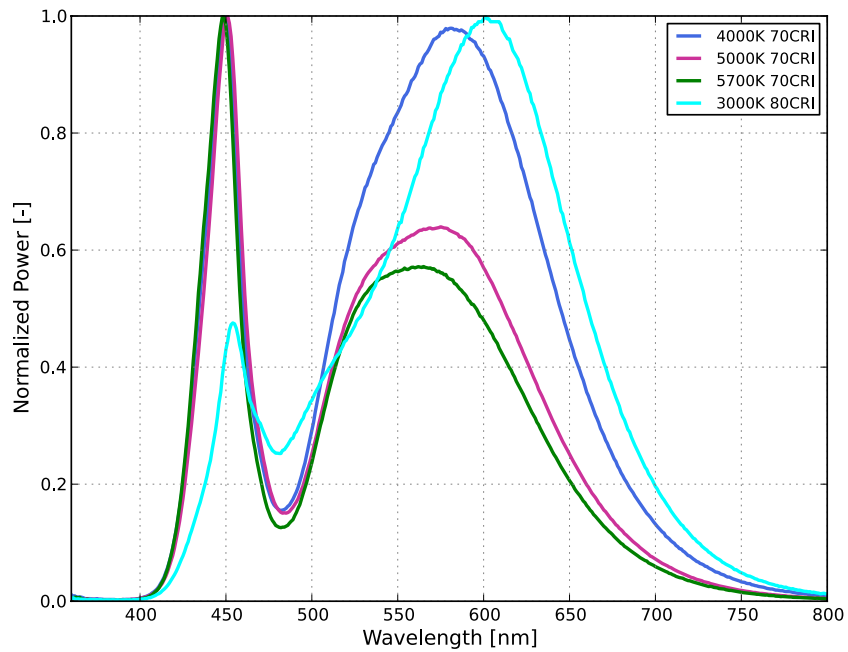

Figure 1b. Typical normalized power vs. wavelength for LUXEON CZ White at 350mA, $T_j=85^\circ\text{C}$.

Light Output Characteristics

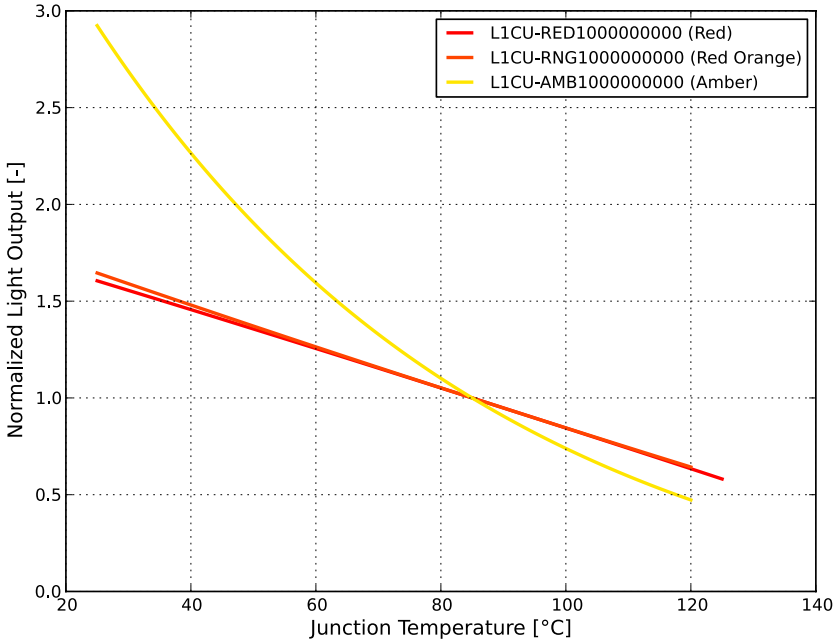

Figure 2a. Typical normalized light output vs. junction temperature for LUXEON CZ Red, Red-Orange and Amber at 350mA.

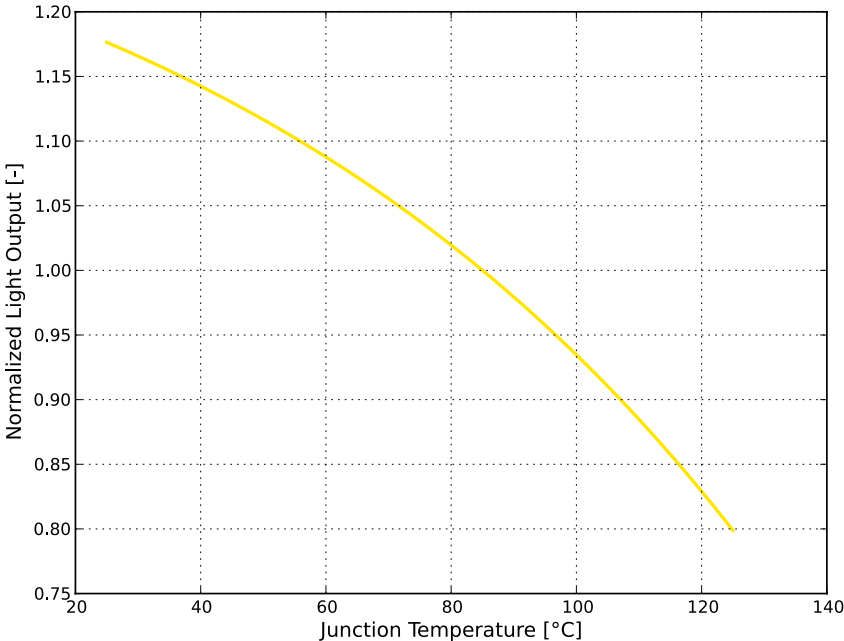

Figure 2b. Typical normalized light output vs. junction temperature for LUXEON CZ PC Amber at 350mA.

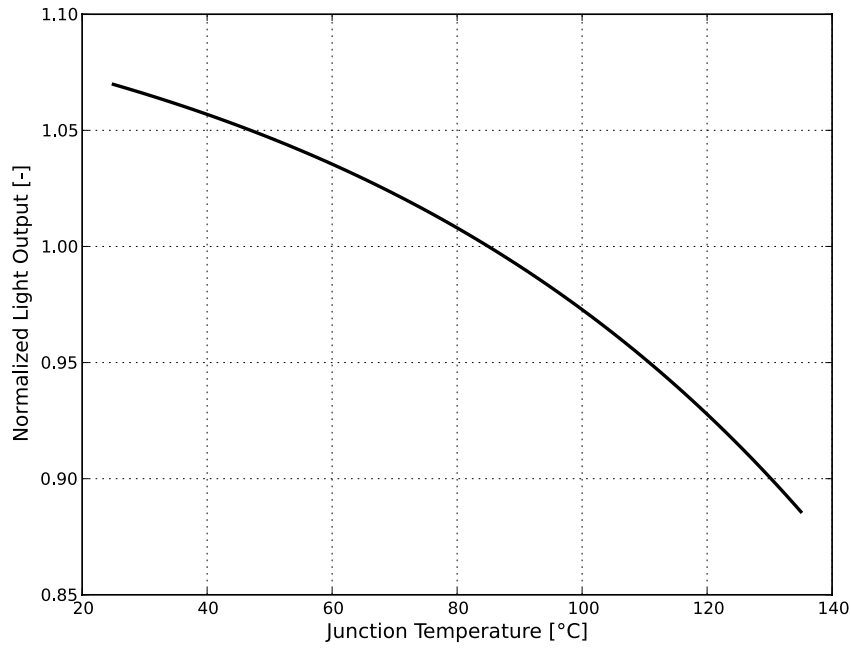

Figure 2c. Typical normalized light output vs. junction temperature for LUXEON CZ Mint at 350mA.

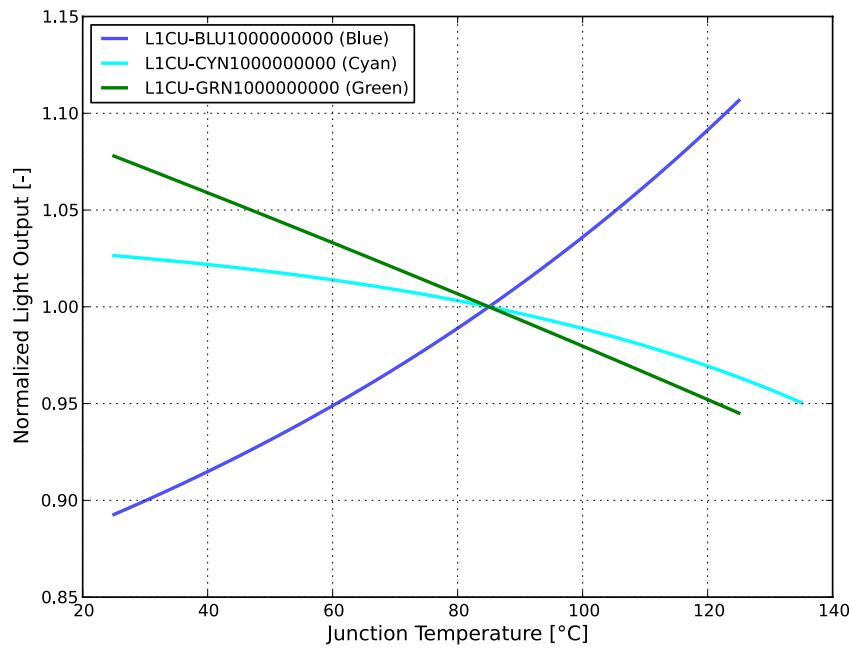

Figure 2d. Typical normalized light output vs. junction temperature for LUXEON CZ Green, Cyan and Blue at 350mA.

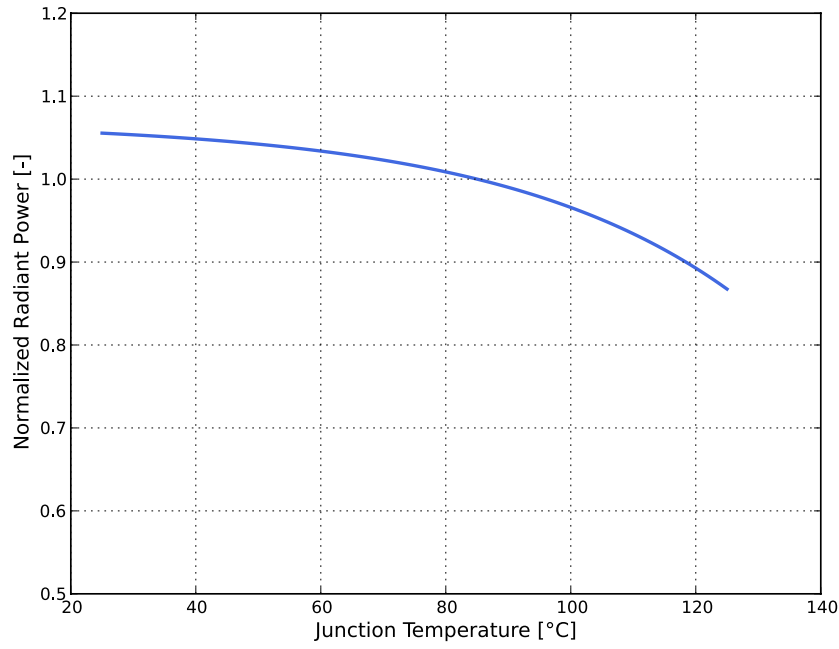

Figure 2e. Typical normalized radiant power vs. junction temperature for LUXEON CZ Royal Blue at 350mA.

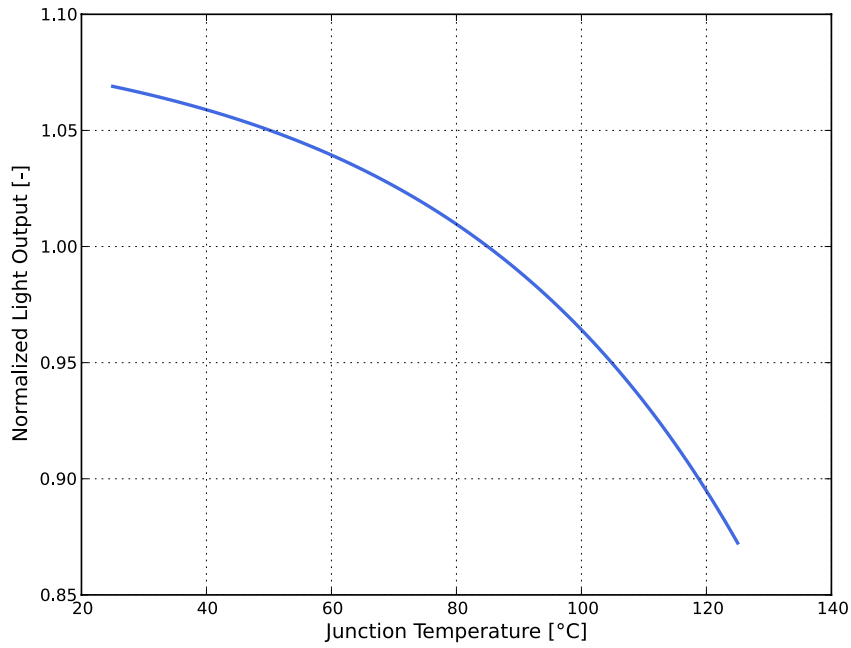

Figure 2f. Typical normalized light output vs. junction temperature for LUXEON CZ White at 350mA.

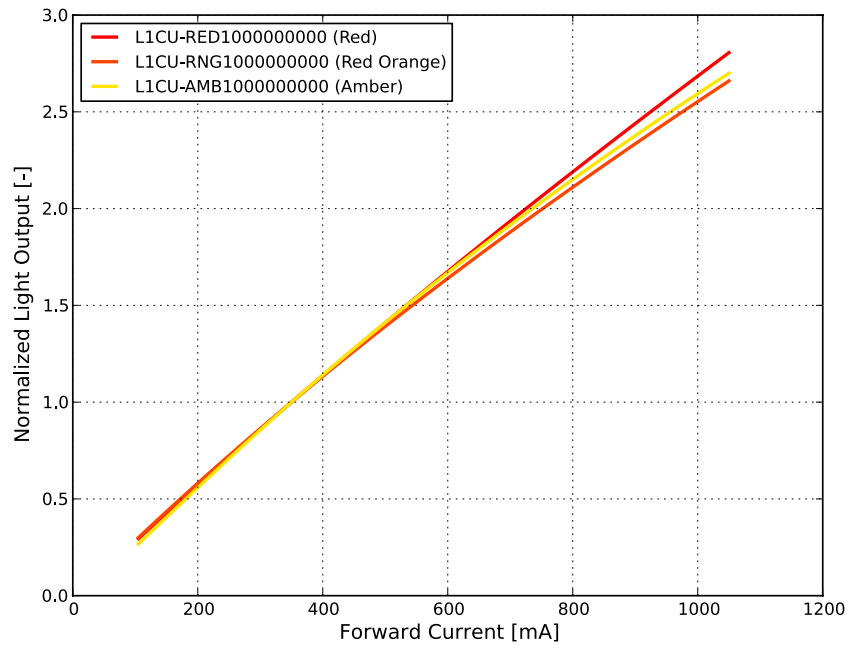

Figure 3a. Typical normalized light output vs. forward current for LUXEON CZ Red, Red-Orange and Amber at $T_j=85^\circ\text{C}$.

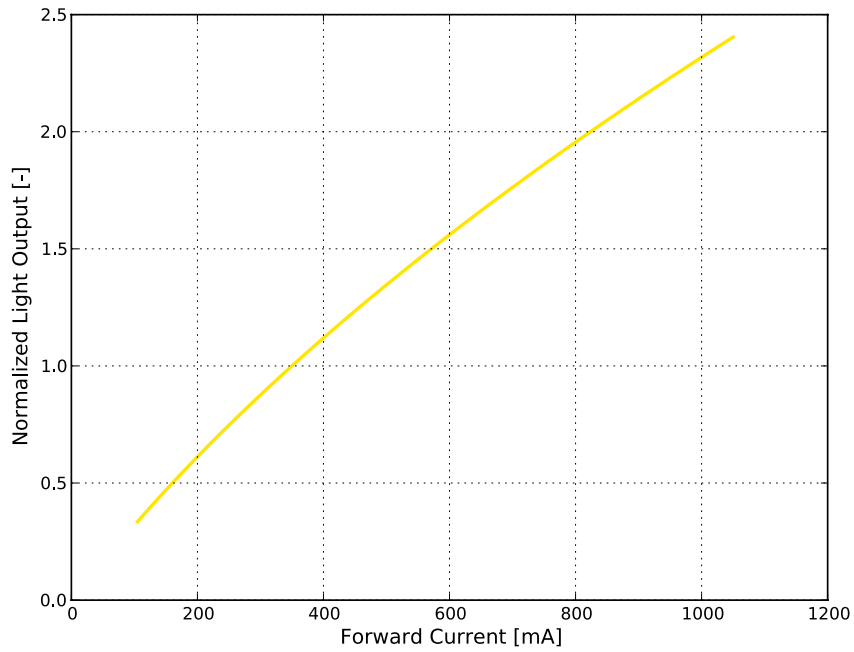

Figure 3b. Typical normalized light output vs. forward current for LUXEON CZ PC Amber at $T_j=85^\circ\text{C}$.

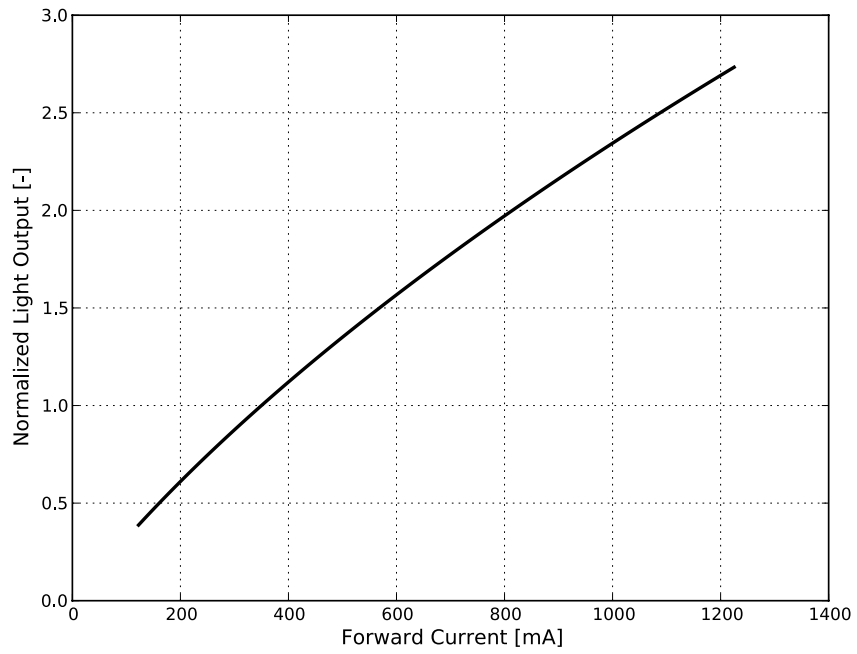

Figure 3c. Typical normalized light output vs. forward current for LUXEON CZ Mint at $T_j=85^\circ\text{C}$.

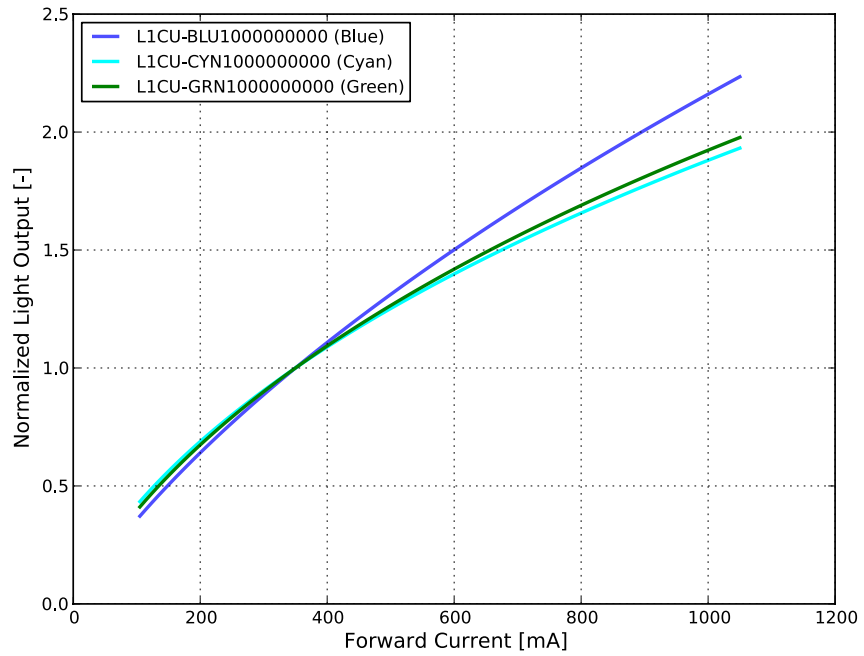

Figure 3d. Typical normalized light output vs. forward current for LUXEON CZ Green, Cyan and Blue at $T_j=85^\circ\text{C}$.

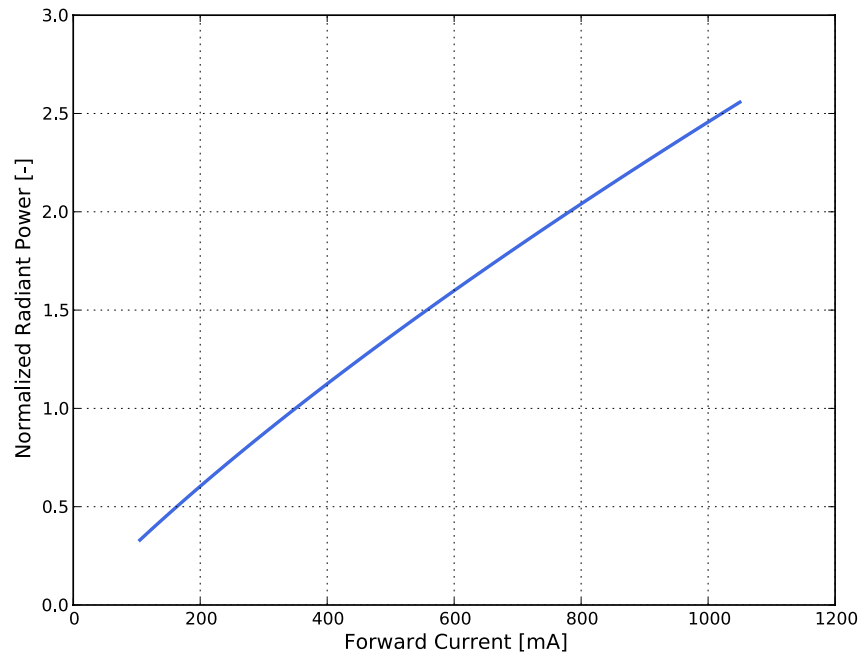

Figure 3e. Typical normalized radiant power vs. forward current for LUXEON CZ Royal Blue at $T_j=85^\circ\text{C}$.

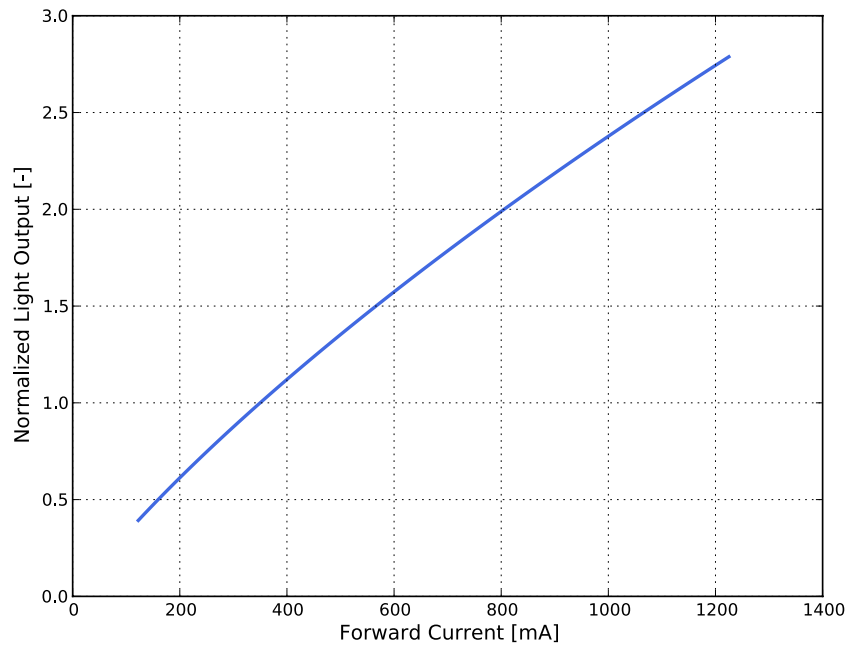

Figure 3f. Typical normalized light output vs. forward current for LUXEON CZ White at $T_j=85^\circ\text{C}$.

Forward Current Characteristics

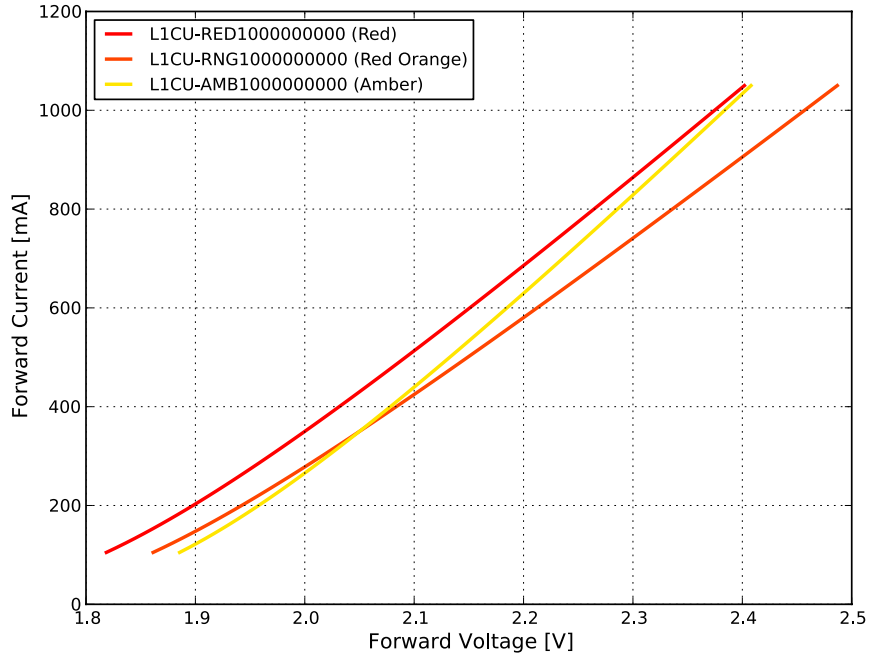

Figure 4a. Typical forward current vs. forward voltage for LUXEON CZ Red, Red-Orange and Amber at $T_j=85^{\circ}\text{C}$.

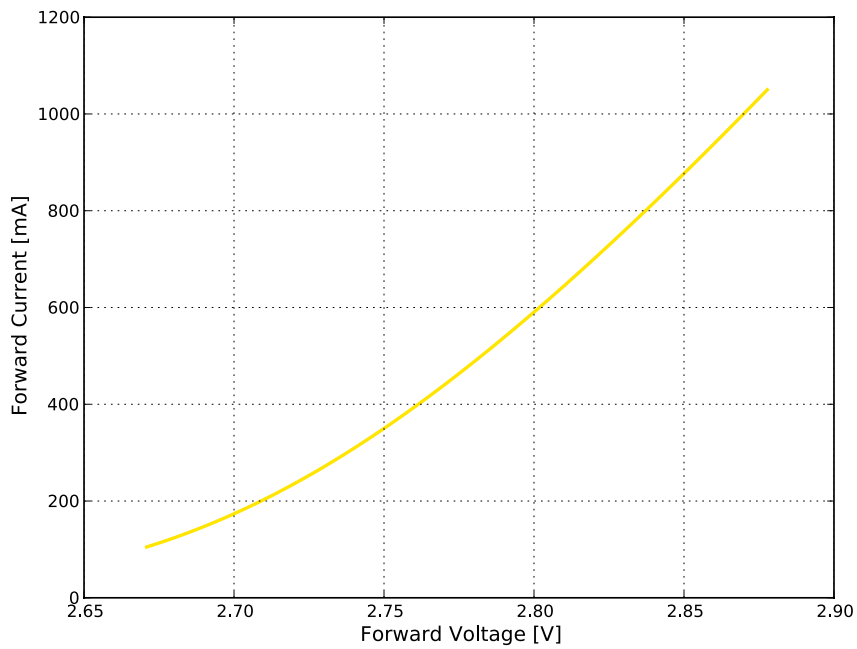

Figure 4b. Typical forward current vs. forward voltage for LUXEON CZ PC Amber at $T_j=85^{\circ}\text{C}$.

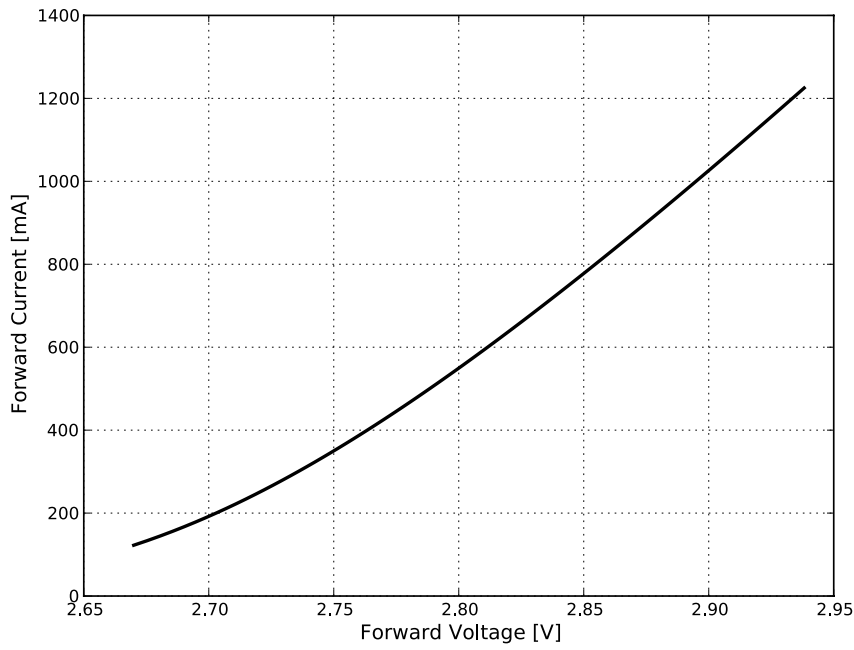

Figure 4c. Typical forward current vs. forward voltage for LUXEON CZ Mint at $T_j=85^\circ\text{C}$.

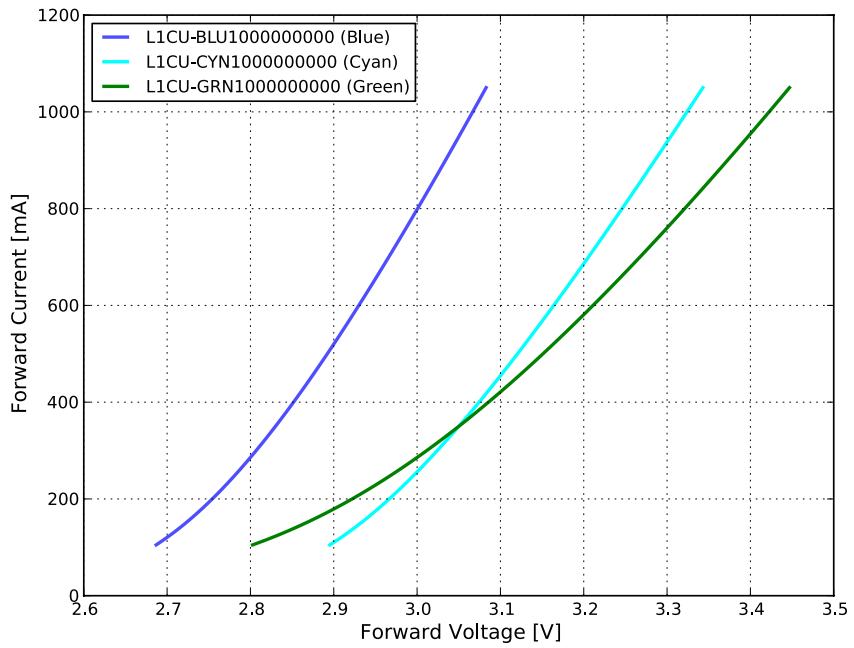

Figure 4d. Typical forward current vs. forward voltage for LUXEON CZ Green, Cyan and Blue at $T_j=85^\circ\text{C}$.

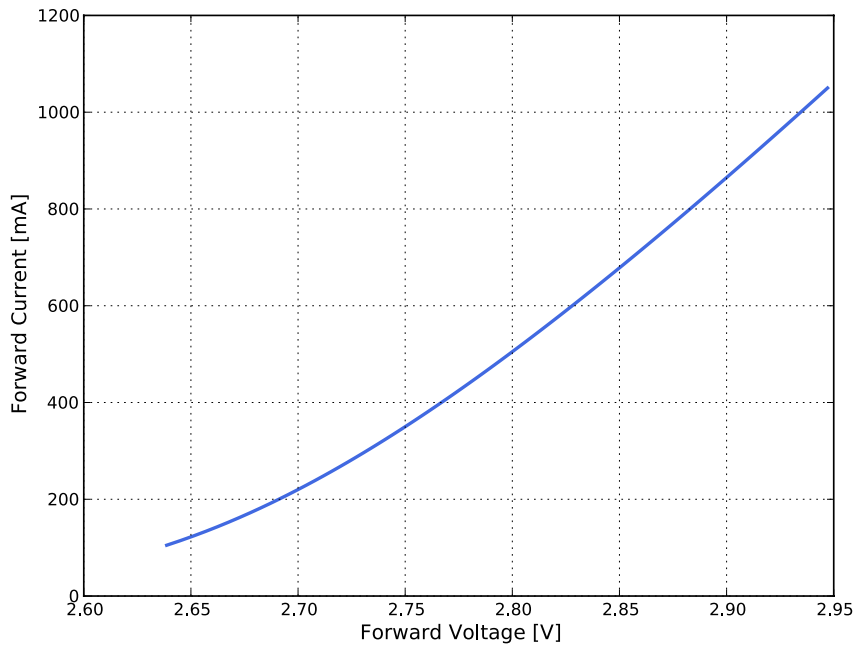

Figure 4e. Typical forward current vs. forward voltage for LUXEON CZ Royal Blue at $T_j=85^\circ\text{C}$.

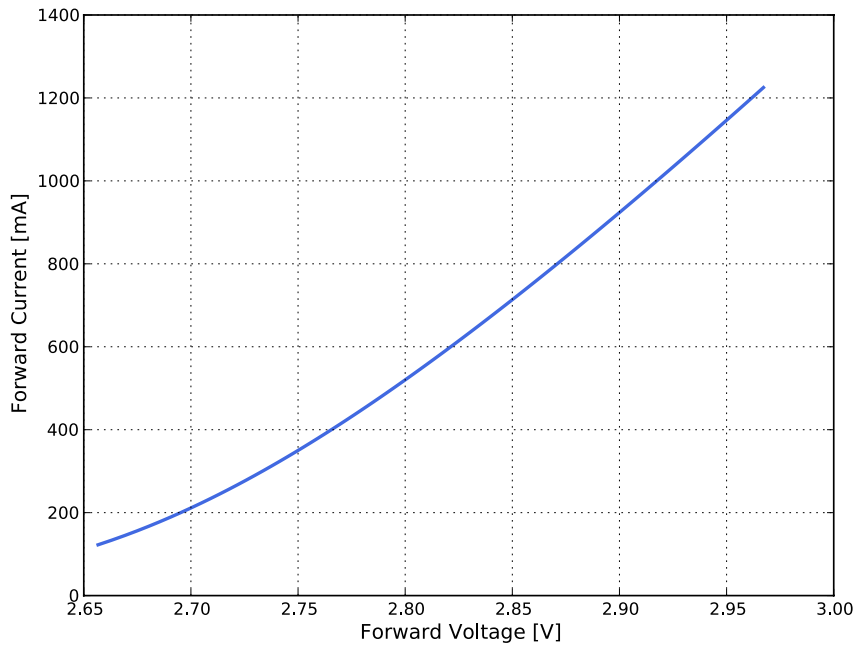

Figure 4f. Typical forward current vs. forward voltage for LUXEON CZ White at $T_j=85^\circ\text{C}$.

Radiation Pattern Characteristics

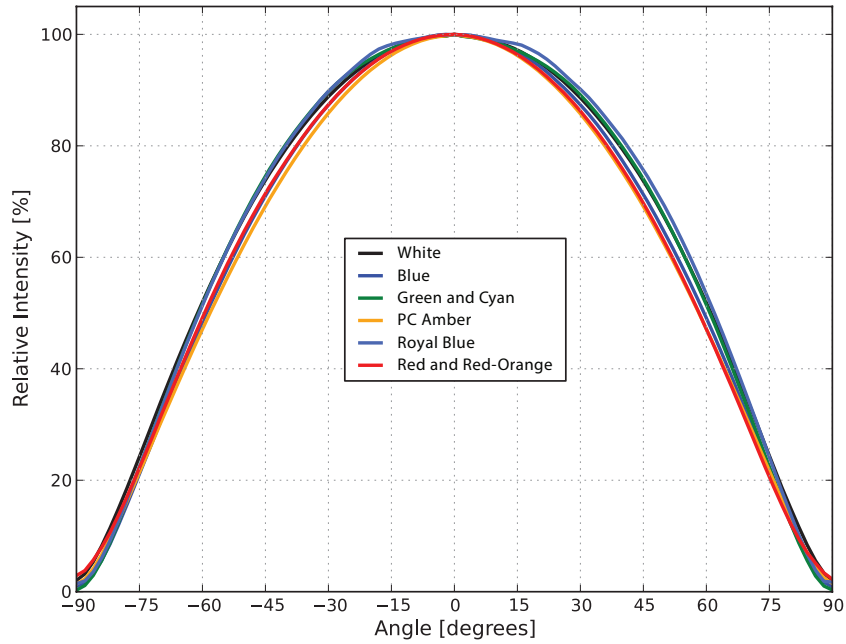

Figure 5. Typical radiation pattern for LUXEON CZ Red, Red-Orange, PC Amber, Green, Cyan, Blue, Royal Blue and White at 350mA, $T_j=85^{\circ}\text{C}$.

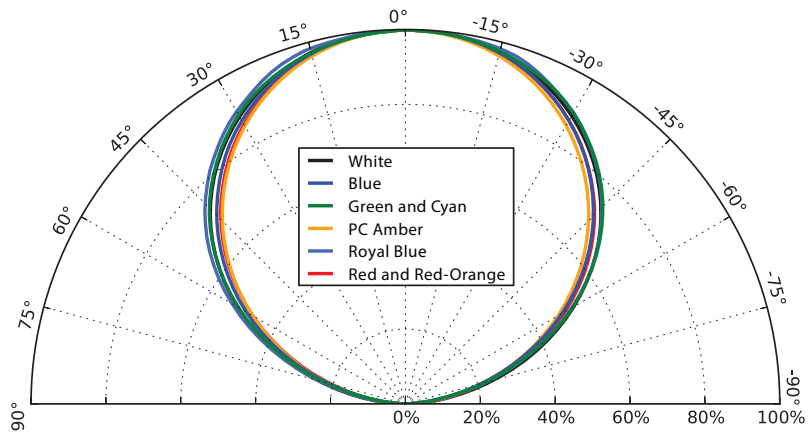

Figure 6. Typical polar radiation pattern for LUXEON CZ Red, Red-Orange, PC Amber, Green, Cyan, Blue, Royal Blue and White at 350mA, $T_j=85^{\circ}\text{C}$.

Product Bin and Labeling Definitions

Decoding Product Bin Labeling

In the manufacturing of semiconductor products, there are variations in performance around the average values given in the technical datasheet. For this reason, Lumileds bins LED components for luminous flux, radiometric power, color point, peak wavelength, dominant wavelength and forward voltage.

LUXEON CZ Color Line LEDs are labeled using a 4-digit alphanumeric CAT code following the format below:

A B C D

Where:

- A** – designates luminous flux or radiometric power bin (example: A=20 to 25 lumens, B=25 to 30 lumens, H=480 to 520mW, J=520 to 560mW)
- B C** – designates color, peak or dominant wavelength bin (example: Red 40=624 to 634nm, Royal Blue 50=450 to 455nm)
- D** – designates forward voltage bin (example: A=1.7 to 1.9V, B=1.9 to 2.1V)

Therefore, a LUXEON CZ Red LED with a lumen range of 20 to 25, a dominant wavelength of 624 to 634nm and a forward voltage range of 1.7 to 1.9V has the following CAT Code:

A 4 0 A

Luminous Flux Bins

Table 5 lists the standard photometric luminous flux bins for LUXEON CZ Color Line emitters. Although several bins are outlined, product availability in a particular bin varies by production run and by product performance. Not all bins are available in all CCTs.

Table 5. Luminous flux bin definitions for LUXEON CZ Color Line.

BIN	LUMINOUS FLUX ^[1] (lm)	
	MINIMUM	MAXIMUM
A	20	25
B	25	30
C	30	35
D	35	40
E	40	45
F	45	50
G	50	55
H	55	60
J	60	65
K	65	70
L	70	75
M	75	80
N	80	90
P	90	100
Q	100	110
R	110	120
S	120	130
T	130	140
U	140	150
V	150	170
W	170	190

Notes for Table 5:

1. Lumileds maintains a tolerance of $\pm 6.5\%$ on luminous flux measurements.

Radiometric Power Bins

Table 6. Radiometric power bin definitions for LUXEON CZ Royal Blue.

COLOR	PART NUMBER	BIN	RADIOMETRIC POWER ^[1] (mW)	
			MINIMUM	MAXIMUM
Royal Blue	L1CU-RYL1000000000	F	400	440
		G	440	480
		H	480	520

Notes for Table 6:

1. Lumileds maintains a tolerance of $\pm 6.5\%$ on radiometric power measurements.

Color Bin Definitions

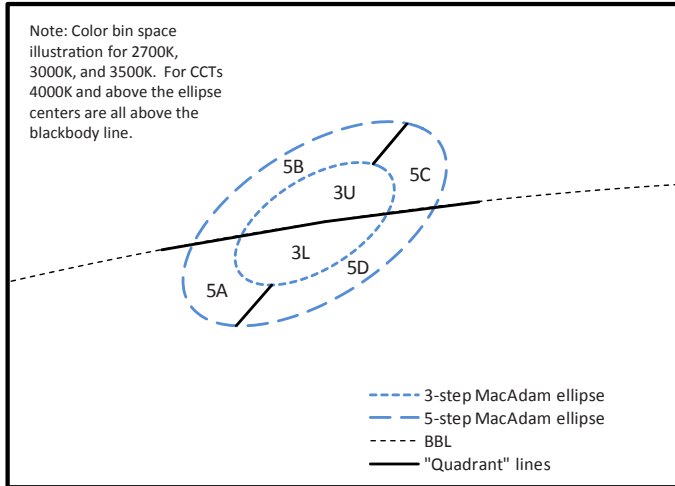

Figure 7. Color bin structure for LUXEON CZ Color Line.

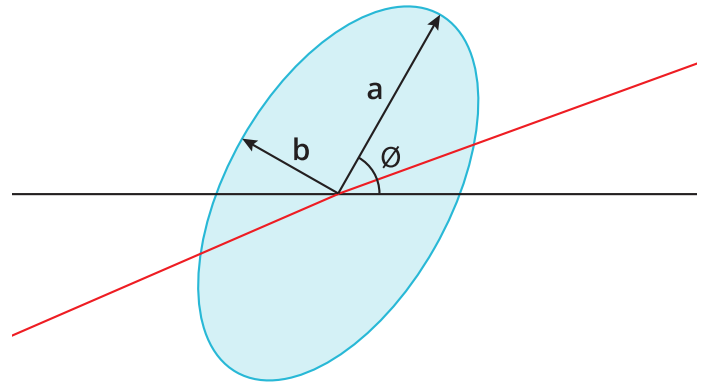

Figure 8. 3- and 5-step MacAdam ellipse illustration for Table 7.

Table 7a. 5-Step MacAdam ellipse color bin definitions for LUXEON CZ White at 350mA, $T_j=85^\circ\text{C}$

NOMINAL CCT	COLOR SPACE	CENTER POINT ^[1] (cx, cy)	MAJOR AXIS, a	MINOR AXIS, b	ELLIPSE ROTATION ANGLE, θ
3000K	Single 3-Step MacAdam Ellipse	(0.4338, 0.4030)	0.00834	0.00408	53.2°
3000K	Single 5-Step MacAdam Ellipse	(0.4338, 0.4030)	0.01390	0.00680	53.2°
5700K	Single 5-Step MacAdam Ellipse	(0.3287, 0.3417)	0.01243	0.00533	59.1°
4000K	Single 5-Step MacAdam Ellipse	(0.3818, 0.3797)	0.01565	0.00670	53.7°
5000K	Single 5-Step MacAdam Ellipse	(0.3447, 0.3553)	0.01370	0.00590	59.6°

Notes for Table 7a:

1. Lumileds maintains a tolerance of ± 0.005 on x and y coordinates in the CIE 1931 color space.

Table 7b. MacAdam ellipse color bin definitions for LUXEON CZ Color Line.

BIN	SDCM
3U	3-step MacAdam ellipse (80CRI)
3L	3-step MacAdam ellipse (80CRI)
50	5-step MacAdam ellipse (70 CRI)
5A	5-step MacAdam ellipse (80CRI)
5B	5-step MacAdam ellipse (80CRI)
5C	5-step MacAdam ellipse (80CRI)
5D	5-step MacAdam ellipse (80CRI)

Dominant Wavelength Bins

Table 8. Dominant wavelength bins for LUXEON CZ Red, Green, Cyan and Blue at 350mA, T_j=85°C.

COLOR	PART NUMBER	BIN	RADIOMETRIC POWER ^[1] (mW)	
			MINIMUM	MAXIMUM
Red	L1CU-RED1000000000	40	624.0	634.0
Red-Orange	L1CU-RNG1000000000	20	614.0	624.0
Amber	L1CU-AMB1000000000	10	585.0	590.0
		20	590.0	594.5
		30	594.5	600.0
Green	L1CU-GRN1000000000	10	520.0	525.0
		20	525.0	530.0
		30	530.0	535.0
		40	535.0	540.0
Cyan	L1CU-CYN1000000000	10	490.0	496.0
		20	496.0	500.0
		30	500.0	505.0
		40	505.0	510.0
Blue	L1CU-BLU1000000000	10	460.0	465.0
		20	465.0	470.0
		30	470.0	475.0
		40	475.0	480.0
		50	480.0	485.0

Notes for Table 8:

1. Lumileds maintains a tolerance of ±0.5nm on dominant wavelength measurements.

Peak Wavelength Bins

Table 9. Peak wavelength bins for LUXEON CZ Royal Blue at 350mA, T_j=85°C.

COLOR	PART NUMBER	BIN	PEAK WAVELENGTH ^[1] (nm)	
			MINIMUM	MAXIMUM
Royal Blue	L1CU-RYL1000000000	30	440	445
		40	445	450
		50	450	455
		60	455	460

Notes for Table 9:

1. Lumileds maintains a tolerance of ±2.0nm on peak wavelength measurements.

Color Bin Structure

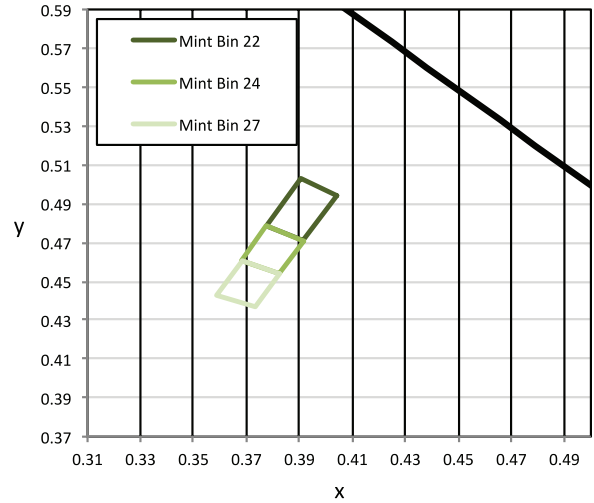
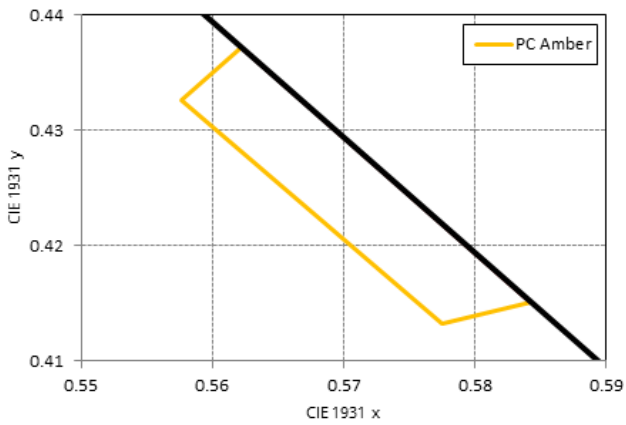

Figure 9. Color bin structure for LUXEON CZ PC Amber for Table 10. Figure 10. Color bin structure for LUXEON CZ Mint for Table 10.

Table 10. Color bin definitions for LUXEON CZ PC Amber.

COLOR	PART NUMBER	BIN	x	y
PC Amber	L1CU-PCA1000000000	20	0.5622	0.4372
			0.5576	0.4326
			0.5775	0.4132
			0.5843	0.4151
Mint	L1CU-MNT1000000000	22	0.4041	0.4941
			0.3901	0.5030
			0.3775	0.4787
		24	0.3916	0.4711
			0.3916	0.4711
			0.3775	0.4787
			0.3681	0.4606
		27	0.3823	0.4540
			0.3823	0.4540
			0.3681	0.4606
			0.3587	0.4425
			0.3730	0.4369

Notes for Table 10:

1. Lumileds maintains a tolerance of ± 0.005 on x and y color coordinates measurements.

Forward Voltage Bins

Table 11. Forward voltage bin definitions for LUXEON CZ Color Line.

BIN	FORWARD VOLTAGE ⁽¹⁾ (V _f)	
	MINIMUM	MAXIMUM
Z	1.50	1.70
A	1.70	1.90
B	1.90	2.10
C	2.10	2.30
D	2.30	2.50
E	2.50	2.70
F	2.70	2.90
G	2.90	3.10
H	3.10	3.30

Notes for Table 11:

1. Lumileds maintains a tolerance of $\pm 0.06V$ on forward voltage measurements.

Mechanical Dimensions

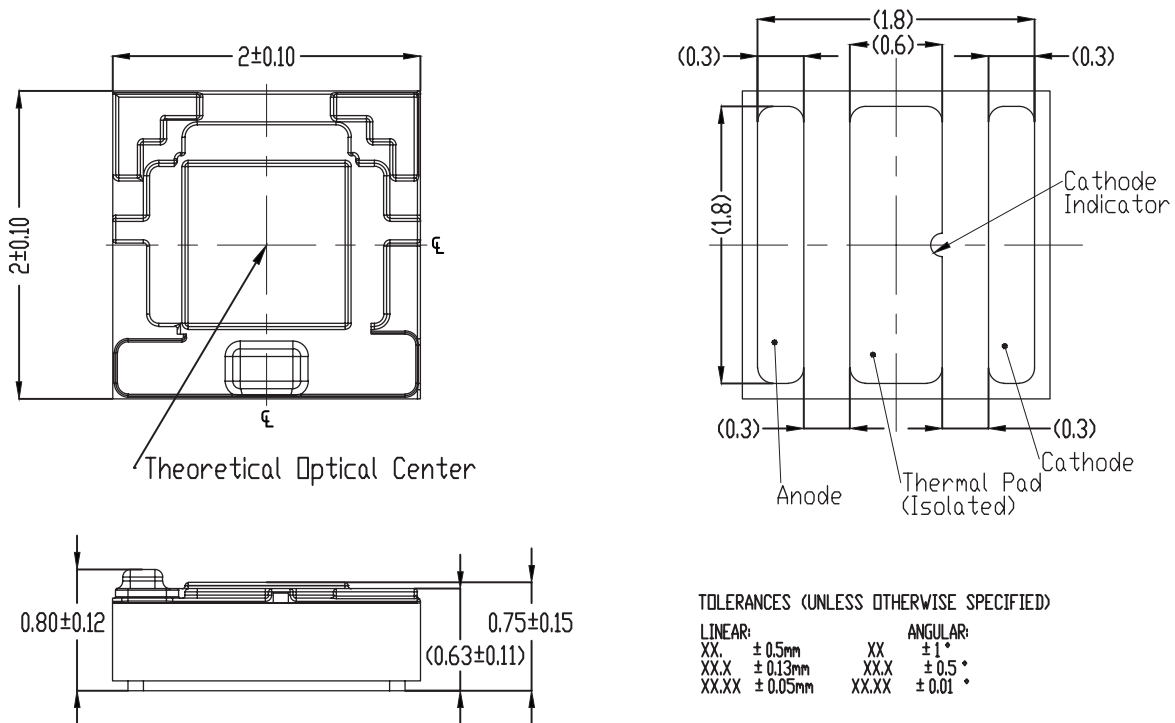

Figure 11. Mechanical dimensions for LUXEON CZ Color Line.

Notes for Figure 11:

1. Drawings are not to scale.
2. All dimensions are in millimeters.

Reflow Soldering Guidelines

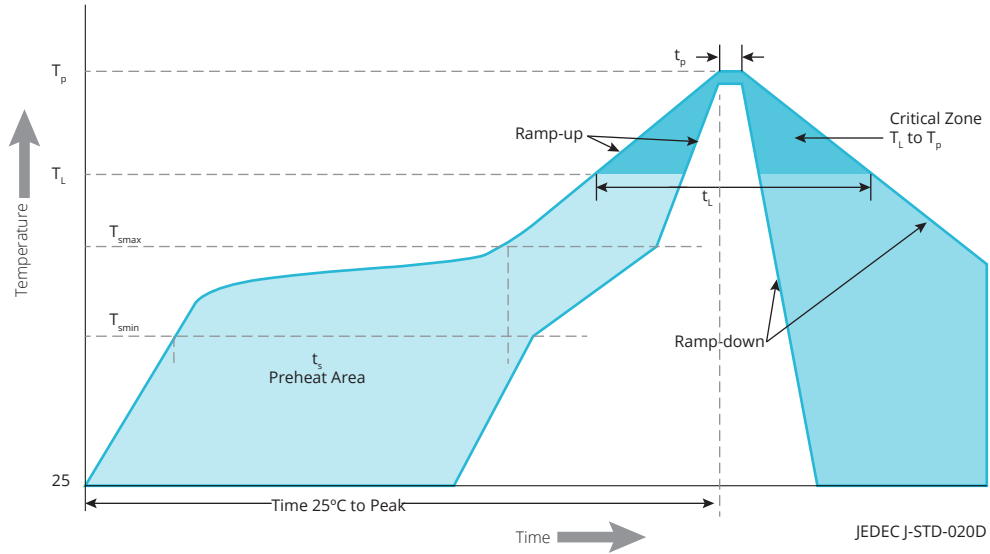

Figure 12. Visualization of the acceptable reflow temperature profile as specified in Table 12.

Table 12. Reflow profile characteristics for LUXEON CZ Color Line.

PROFILE FEATURE	LEAD-FREE ASSEMBLY
Preheat Minimum Temperature (T_{smin})	150°C
Preheat Maximum Temperature (T_{smax})	200°C
Preheat Time (t_{smin} to t_{smax})	60 to 120 seconds
Ramp-Up Rate (T_L to T_p)	3°C / second maximum
Liquidus Temperature (T_L)	217°C
Time Maintained Above Temperature T_L (t_L)	60 to 150 seconds
Peak / Classification Temperature (T_p)	260°C
Time Within 5°C of Actual Temperature (t_p)	20 to 40 seconds
Ramp-Down Rate (T_p to T_L)	6°C / second maximum
Time 25°C to Peak Temperature	8 minutes maximum

JEDEC Moisture Sensitivity

Table 13. Moisture sensitivity levels for LUXEON CZ Color Line.

LEVEL	FLOOR LIFE		SOAK REQUIREMENTS STANDARD	
	TIME	CONDITIONS	TIME	CONDITIONS
1	Unlimited	≤30°C / 85% RH	168 Hours +5 / -0	85°C / 85% RH

Solder Pad Design

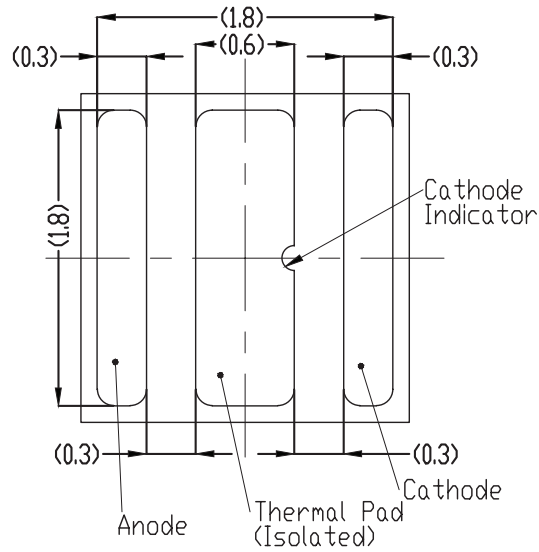

Figure 13. Recommended PCB solder pad layout for LUXEON CZ Color Line.

Notes for Figure 13:

1. Drawings are not to scale.
2. All dimensions are in millimeters.

Packaging Information

Pocket Tape Dimensions

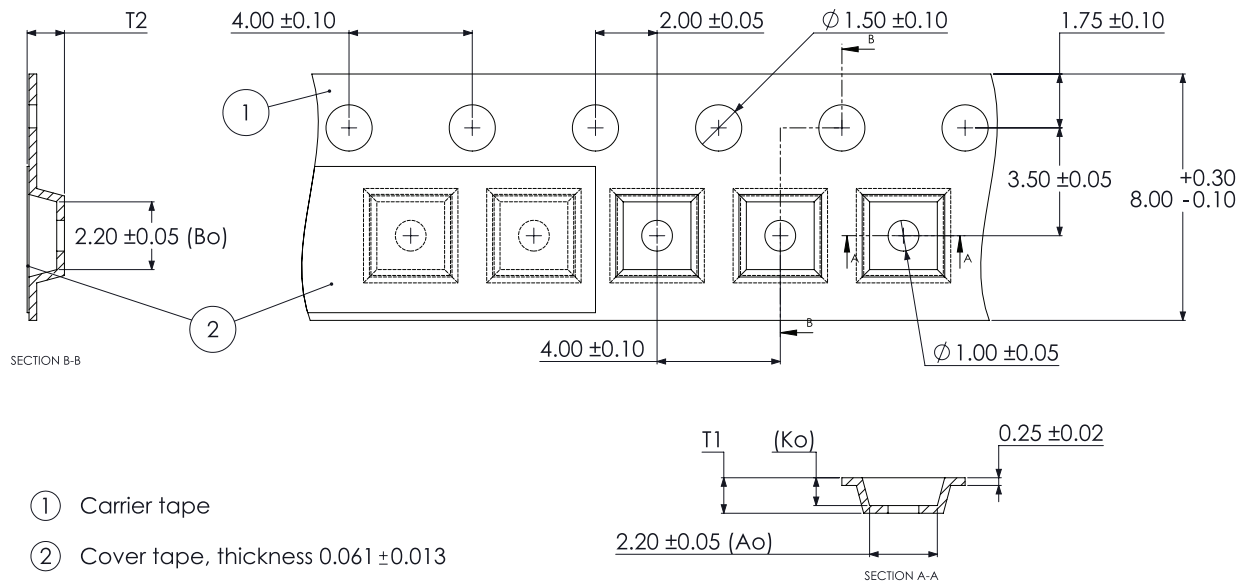

- ① Carrier tape
- ② Cover tape, thickness 0.061 ± 0.013

Figure 14. Pocket Tape dimensions for LUXEON CZ Color Line.

Notes for Figure 14:

1. Drawings are not to scale.
2. All dimensions are in millimeters.

Reel Dimensions

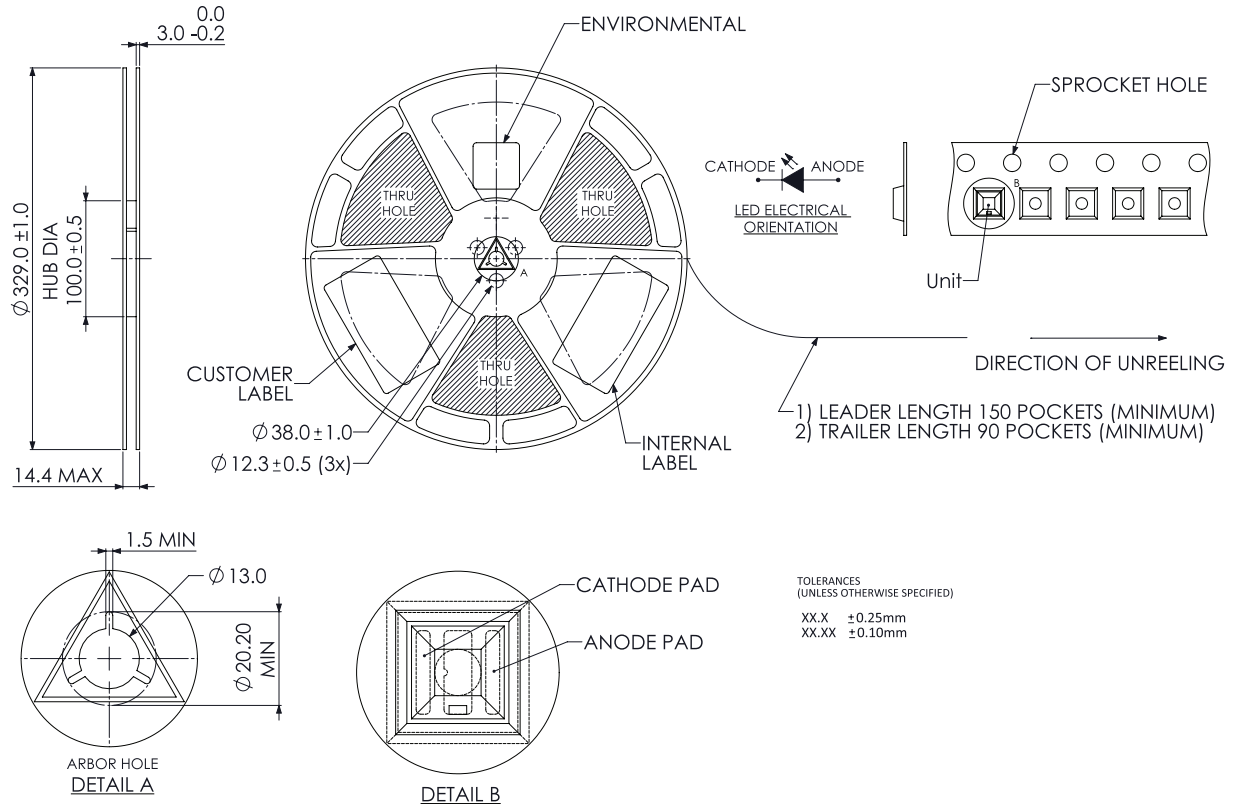

Figure 15. Reel dimensions for LUXEON CZ Color Line.

Notes for Figure 15:

1. Drawings are not to scale.
2. All dimensions are in millimeters.
3. Maximum 1000 pieces per reel.

About Lumileds

Companies developing automotive, mobile, IoT and illumination lighting applications need a partner who can collaborate with them to push the boundaries of light. With over 100 years of inventions and industry firsts, Lumileds is a global lighting solutions company that helps customers around the world deliver differentiated solutions to gain and maintain a competitive edge. As the inventor of Xenon technology, a pioneer in halogen lighting and the leader in high performance LEDs, Lumileds builds innovation, quality and reliability into its technology, products and every customer engagement. Together with its customers, Lumileds is making the world safer, better and more beautiful—with light.

To learn more about our lighting solutions, visit lumileds.com.



©2018 Lumileds Holding B.V. All rights reserved.
LUXEON is a registered trademark of the Lumileds Holding B.V. in the United States and other countries.

lumileds.com

Neither Lumileds Holding B.V. nor its affiliates shall be liable for any kind of loss of data or any other damages, direct, indirect or consequential, resulting from the use of the provided information and data. Although Lumileds Holding B.V. and/or its affiliates have attempted to provide the most accurate information and data, the materials and services information and data are provided "as is," and neither Lumileds Holding B.V. nor its affiliates warrants or guarantees the contents and correctness of the provided information and data. Lumileds Holding B.V. and its affiliates reserve the right to make changes without notice. You as user agree to this disclaimer and user agreement with the download or use of the provided materials, information and data. A listing of Lumileds product/patent coverage may be accessed at lumileds.com/patents.