

Delta Electronics, Inc.
No.252, Shanying Rd., Guishan Dist.,
Taoyuan City 333, Taiwan (R.O.C.)

TEL : 886-(0)3-3591968
FAX : 886-(0)3-3591991

Specification For Reference

Customer : STANDARD

Description : DC FAN

Customer P/N :

rev. :

Delta model no. : ASB0405SA-00

Delta Safety Model No.: N/A

Sample revision. : X01

Issue no.:

Sample issue date : DEC.25 2017

Quantity :

1. SCOPE:

THIS SPECIFICATION DEFINES THE ELECTRICAL AND MECHANICAL CHARACTERISTICS OF THE DC BRUSHLESS AXIAL FLOW FAN.

2. CHARACTERS:

ITEM	DESCRIPTION
RATED VOLTAGE	5V
OPERATION VOLTAGE	4.5 - 5.5 VDC
INPUT CURRENT(AVG.)	0.18 (MAX. 0.28) A SAFETY CURRENT ON LABEL : N/A
INPUT POWER(AVG.)	0.9 (MAX. 1.4) W
SPEED	8000+/-15% R.P.M.
MAX. AIR FLOW (AT ZERO STATIC PRESSURE)	0.251 (MIN. 0.208) M ³ /MIN. 8.860 (MIN. 7.353) CFM
MAX. AIR PRESSURE (AT ZERO AIRFLOW)	5.940 (MIN. 4.092) mmH ₂ O 0.234 (MIN. 0.161) inchH ₂ O
ACOUSTICAL NOISE AT 1M (AVG.)	33.5 (MAX. 38.5) dB-A
INSULATION TYPE	UL: CLASS A
INSULATION STRENGT	10 MEG OHM MIN. AT 500 VDC (BETWEEN FRAME AND (+) TERMINAL)
DIELECTRIC STRENGTH	5 mA MAX. AT 500 VAC 50/60 Hz ONE MINUTE, (BETWEEN FRAME AND (+) TERMINAL)

(continued)

PART NO:

DELTA MODEL: ASB0405SA-00

LIFE EXPECTANCE (L10) (AT LABEL VOLTAGE)	80000 HOURS CONTINUOUS OPERATION AT 40 ° C WITH 15 ~ 65 %RH.
ROTATION	CLOCKWISE VIEW FROM NAME PLATE SIDE

NOTES:

1. ALL READINGS ARE MEASURED AFTER STABLY WARMING UP THROUGH 10 MINUTES.
2. STANDARD AIR PROPERTY IS AIR AT (Td) 25°C TEMPERATURE, (RH) 65% RELATIVE HUMIDITY , AND (Pb) 760 mmHg BAROMETRIC PRESSURE.
3. THE VALUES WRITTEN IN PARENS , (), ARE LIMITED SPEC.
4. THE CHARACTERS SHOWED IN PAGE 1 IS THE CONDITION OF BOTH FANS RUN.
5. ACOUSTICAL NOISE MEASURING CONDITION:

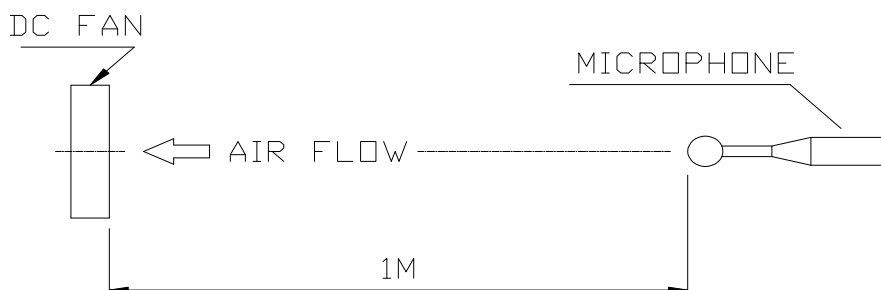

NOISE IS MEASURED AT RATED VOLTAGE IN FREE AIR IN SEMI-ANECHOIC CHAMBER WITH B & K SOUND LEVEL METER WITH MICROPHONE AT A DISTANCE OF 1M FROM THE FAN INTAKE.

PART NO:

DELTA MODEL: ASB0405SA-00

3. MECHANICAL:

- 3-1. DIMENSIONS----- SEE DIMENSIONS DRAWING
- 3-2. FRAME----- PLASTIC UL: 94V-0
- 3-3. IMPELLER----- PLASTIC UL: 94V-0
- 3-4. BEARING SYSTEM----- SLEEVE BEARING
- 3-5. WEIGHT----- 13.5 GRAMS(REF.)

4. ENVIRONMENTAL:

- 4-1. OPERATING TEMPERATURE----- -20 TO +90 DEGREE C
- 4-2. STORAGE TEMPERATURE----- -40 TO +90 DEGREE C
- 4-3. OPERATING HUMIDITY----- 5 TO 90 % RH
- 4-4. STORAGE HUMIDITY----- 5 TO 95 % RH

5. PROTECTION:

- 5-1. LOCKED ROTOR PROTECTION
IMPEDANCE OF MOTOR WINDING PROTECTS MOTOR FROM FIRE IN
96 HOURS OF LOCKED ROTOR CONDITION AT THE RATED VOLTAGE.

6. RE OZONE DEPLETING SUBSTANCES:

- 6-1. NO CONTAINING PBBs, PBBOs, CFCs, PBBEs, PBDPEs AND HCFCs.

7. PRODUCTION LOCATION

- 7-1. PRODUCTS WILL BE PRODUCED IN CHINA OR THAILAND.

PART NO:

DELTA MODEL: ASB0405SA-00

8. P & Q CURVE:

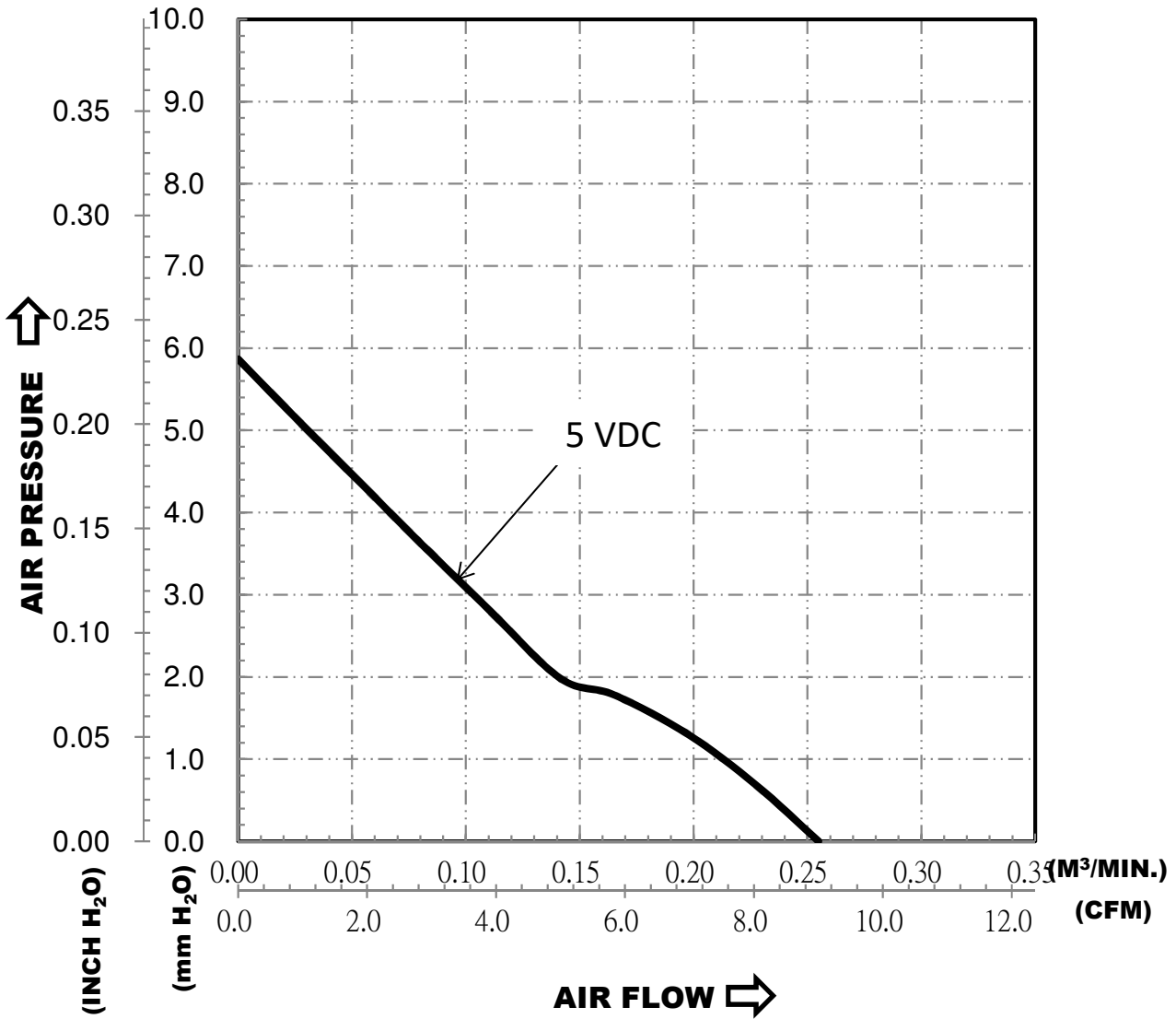

*TEST CONDITION: INPUT VOLTAGE-----OPERATION VOLTAGE
TEMPERATURE-----ROOM TEMPERATURE
HUMIDITY-----65%RH

PART NO:

DELTA MODEL: ASB0405SA-00

9. DIMENSION DRAWING:

LABEL:

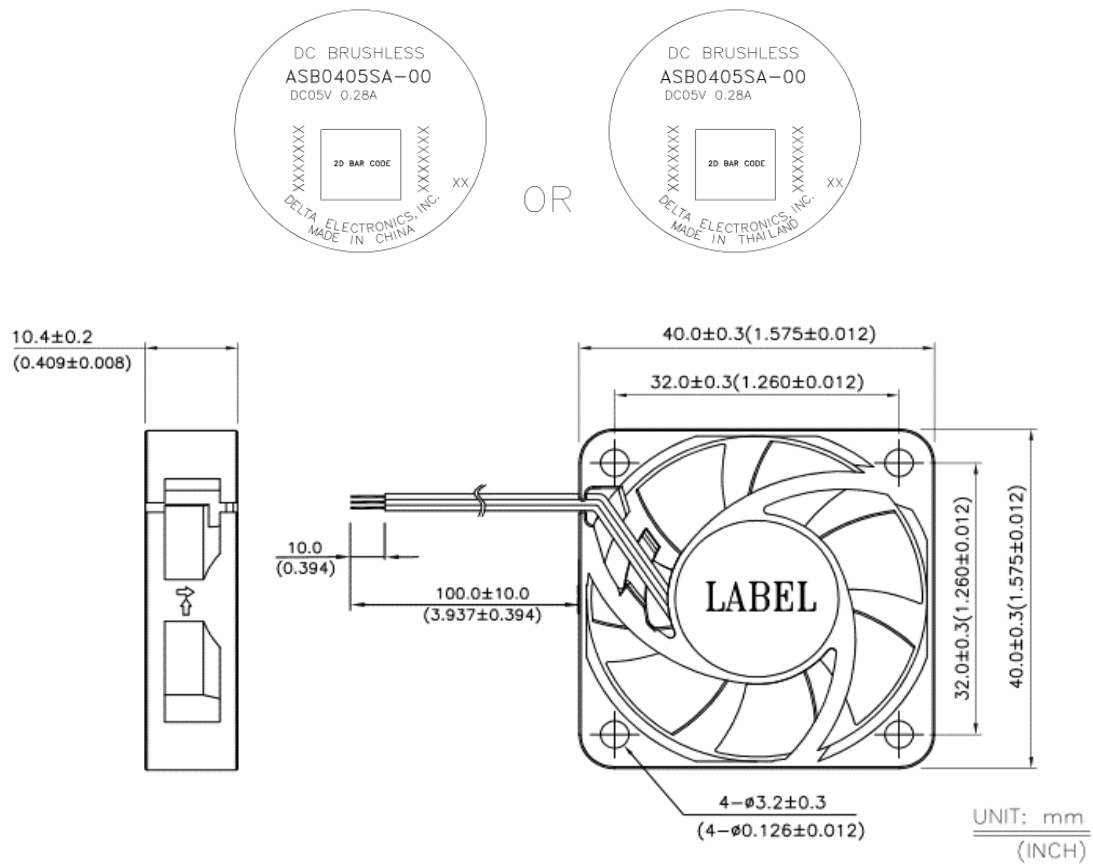

NOTES:



- A. CABLE WIRE UL:10368 AWG#28 (MUST BE APPROVED BY DELTA)
 - RED WIRE (+)
 - BLACK WIRE (-)
 - BLUE WIRE (F00)
- B. This PRODUCT IS RoHS COMPLIANT

PART NO:

DELTA MODEL: ASB0405SA-00

FREQUENCY GENERATOR (FG) SIGNAL:

10. OUTPUT CIRCUIT - OPEN COLLECTOR MODE:

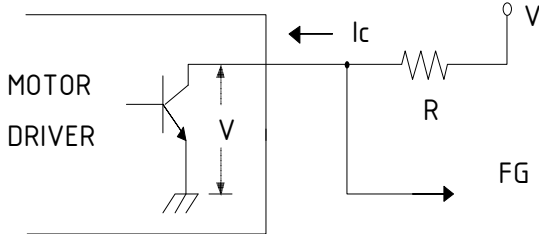

CAUTION:

THE LEAD WIRE OF FG SIGNAL CAN NOT TOUCH THE LEAD WIRE OF POSITIVE OR NEGATIVE.

11. SPECIFICATION:

$V_{FG} = 5.0V \text{ MAX.}$

$I_c = 5mA \text{ MAX.}$

$V_{CE} = 0.5V \text{ MAX.}$

$R \geq V_{FG} / I_c$

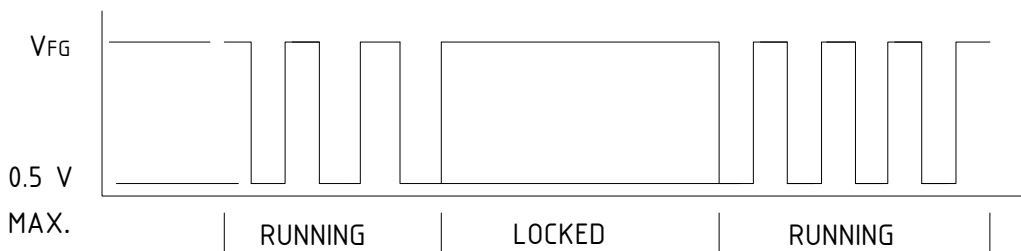

12. FREQUENCY GENERATOR WAVEFORM:

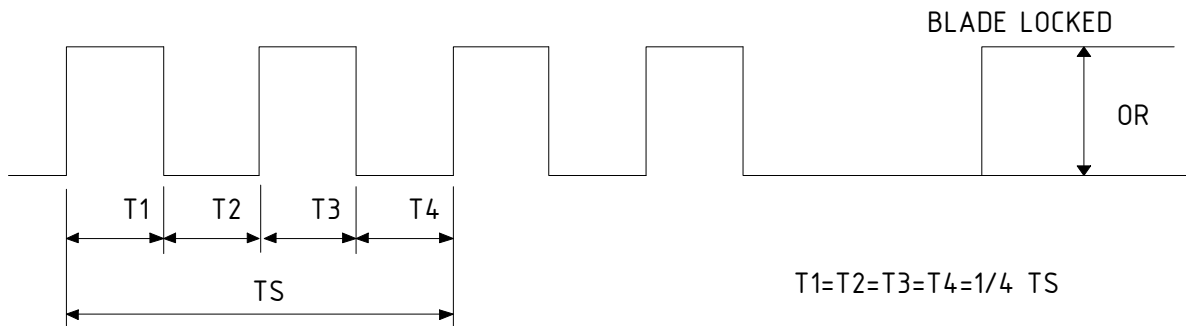

$N = \text{R.P.M}$

$TS = 60/N(\text{SEC})$

*VOLTAGE LEVEL AFTER BLADE LOCKED

*4 POLES

PART NO:

DELTA MODEL: ASB0405SA-00

13. SAFETY NOTICE:

- 13-1. PLEASE DON'T USE THIS PRODUCT BEYOND THIS SPECIFICATION RANGE, IT MAY CAUSE PRODUCT'S BREAKDOWN.
- 13-2. BE CAREFUL WITH INSTALLING PRODUCT IN YOUR MACHINE. TO HIT, DROP, SHAKE MAY CAUSE PRODUCT'S MACHANICAL PROBLEM.
- 13-3. MAKE SURE THAT V(+) AND GND ARE CONNECTED CORRECTLY, OTHERWISE FAN WILL NOT START UP.
- 13-4. TOUCH IMPELLER WHEN ROTATING WILL CAUSE INJURE OR FAN'S FAILURE, MAKE SURE FAN IS OPERATING AT AN ENVIRONMENT WITHOUT LOCKING POSSIBILITY.
- 13-5. AVOID PULLING CABLE WHEN HANDLING FANS,IT MAY CAUSE ELECTRIC FAILURE.
- 13-6. SYSTEM MUST BE POWERED DOWN TO ADD OR REMOVE THE FAN.

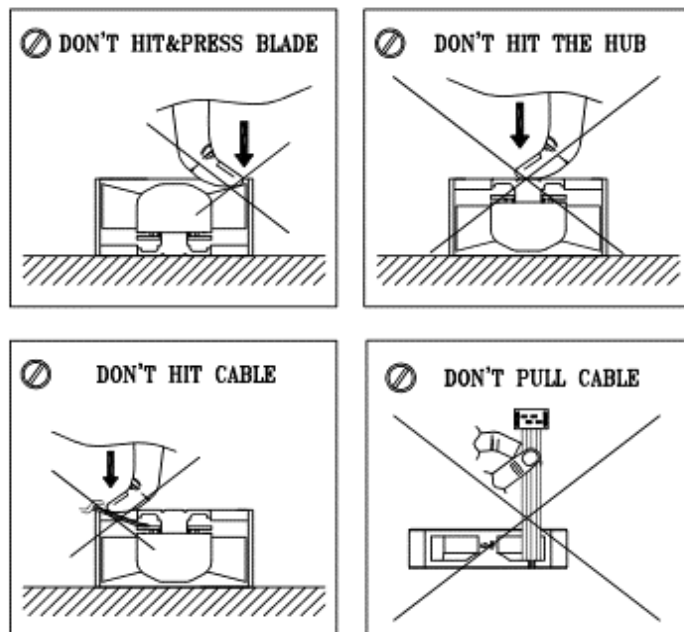



Application Notice

- 1. Delta will not guarantee the performance of the products if the application condition falls outside the parameters set forth in the specification.**
- 2. A written request should be submitted to Delta prior to approval if deviation from this specification is required.**
- 3. Please exercise caution when handling fans. Damage may be caused when pressure is applied to the impeller, if the fans are handled by the lead wires, or if the fan was hard-dropped to the production floor.**
- 4. Except as pertains to some special designs, there is no guarantee that the products will be free from any such safety problems or failures as caused by the introduction of powder, droplets of water or encroachment of insect into the hub.**
- 5. The above-mentioned conditions are representative of some unique examples and viewed as the first point of reference prior to all other information.**
- 6. It is very important to establish the correct polarity before connecting the fan to the power source. Positive (+) and Negative (-). Damage may be caused to the fans if connection is with reverse polarity, if there is no foolproof method to protect against such error specifically mentioned in this spec.**
- 7. Delta fans without special protection are not suitable where any corrosive fluids are introduced to their environment.**
- 8. Please ensure all fans are stored according to the storage temperature limits specified. Do not store fans in a high humidity environment. We highly recommend performance testing is conducted before shipping, if the fans have been stored over 6 months.**
- 9. Not all fans are provided with the Lock Rotor Protection feature. If you impair the rotation of the impeller for the fans that do not have this function, the performance of those fans will lead to failure.**
- 10. Please be cautious when mounting the fan. Incorrect mounting of fans may cause excess resonance, vibration and subsequent noise.**
- 11. It is important to consider safety when testing the fans. A suitable fan guard should be fitted to the fan to guard against any potential for personal injury.**
- 12. Except where specifically stated, all tests are carried out at room (ambient) temperature and relative humidity conditions of 25°C, 65% RH. The test value is only for fan performance itself.**
- 13. Be certain to connect an “4.7μF or greater” capacitor to the fan externally when the application calls for using multiple fans in parallel, to avoid any unstable power.**

Mouser Electronics

Authorized Distributor

Click to View Pricing, Inventory, Delivery & Lifecycle Information:

[Delta Electronics:](#)

[ASB0405SA-00](#)