

# MUN5211DW1, NSBC114EDXV6, NSBC114EDP6

## Dual NPN Bias Resistor Transistors

**R1 = 10 kΩ, R2 = 10 kΩ**

### NPN Transistors with Monolithic Bias Resistor Network

This series of digital transistors is designed to replace a single device and its external resistor bias network. The Bias Resistor Transistor (BRT) contains a single transistor with a monolithic bias network consisting of two resistors; a series base resistor and a base-emitter resistor. The BRT eliminates these individual components by integrating them into a single device. The use of a BRT can reduce both system cost and board space.

#### Features

- Simplifies Circuit Design
- Reduces Board Space
- Reduces Component Count
- S and NSV Prefix for Automotive and Other Applications Requiring Unique Site and Control Change Requirements; AEC-Q101 Qualified and PPAP Capable\*
- These Devices are Pb-Free, Halogen Free/BFR Free and are RoHS Compliant

#### MAXIMUM RATINGS

(T<sub>A</sub> = 25°C, common for Q<sub>1</sub> and Q<sub>2</sub>, unless otherwise noted)

| Rating                         | Symbol               | Max | Unit |
|--------------------------------|----------------------|-----|------|
| Collector-Base Voltage         | V <sub>CBO</sub>     | 50  | Vdc  |
| Collector-Emitter Voltage      | V <sub>CEO</sub>     | 50  | Vdc  |
| Collector Current – Continuous | I <sub>C</sub>       | 100 | mAdc |
| Input Forward Voltage          | V <sub>IN(fwd)</sub> | 40  | Vdc  |
| Input Reverse Voltage          | V <sub>IN(rev)</sub> | 10  | Vdc  |

Stresses exceeding those listed in the Maximum Ratings table may damage the device. If any of these limits are exceeded, device functionality should not be assumed, damage may occur and reliability may be affected.

#### ORDERING INFORMATION

| Device                                | Package | Shipping†            |
|---------------------------------------|---------|----------------------|
| MUN5211DW1T1G,<br>SMUN5211DW1T1G*     | SOT-363 | 3,000 / Tape & Reel  |
| NSVMUN5211DW1T2G*                     | SOT-363 | 3,000 / Tape & Reel  |
| NSVMUN5211DW1T3G*                     | SOT-363 | 10,000 / Tape & Reel |
| NSBC114EDXV6T1G,<br>NSVBC114EDXV6T1G* | SOT-563 | 4,000 / Tape & Reel  |
| NSBC114EDXV6T5G                       | SOT-563 | 8,000 / Tape & Reel  |
| NSBC114EDP6T5G                        | SOT-963 | 8,000 / Tape & Reel  |

†For information on tape and reel specifications, including part orientation and tape sizes, please refer to our Tape and Reel Packaging Specifications Brochure, BRD8011/D.



ON Semiconductor®

[www.onsemi.com](http://www.onsemi.com)

#### PIN CONNECTIONS

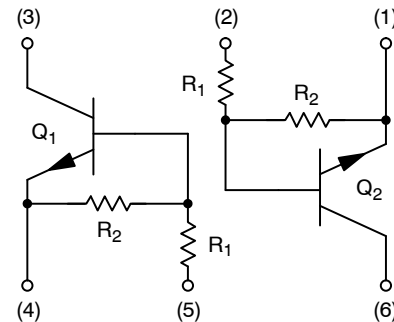

#### MARKING DIAGRAMS

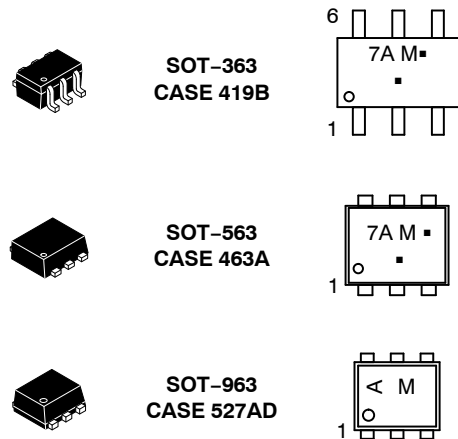

7A/A = Specific Device Code  
M = Date Code\*  
▪ = Pb-Free Package

(Note: Microdot may be in either location)

\*Date Code orientation may vary depending upon manufacturing location.

# MUN5211DW1, NSBC114EDXV6, NSBC114EDP6

## THERMAL CHARACTERISTICS

| Characteristic | Symbol | Max | Unit |
|----------------|--------|-----|------|
|----------------|--------|-----|------|

### MUN5211DW1 (SOT-363) ONE JUNCTION HEATED

|   |                 |                          |                                |
|---|-----------------|--------------------------|--------------------------------|
| Total Device Dissipation<br>$T_A = 25^\circ\text{C}$ (Note 1)<br>(Note 2)<br>Derate above $25^\circ\text{C}$ (Note 1)<br>(Note 2) | $P_D$           | 187<br>256<br>1.5<br>2.0 | mW<br><br>mW/ $^\circ\text{C}$ |
| Thermal Resistance,<br>Junction to Ambient (Note 1)<br>(Note 2)   | $R_{\theta JA}$ | 670<br>490               | $^\circ\text{C/W}$             |

### MUN5211DW1 (SOT-363) BOTH JUNCTION HEATED (Note 3)

|   |                 |                          |                                |
|---|-----------------|--------------------------|--------------------------------|
| Total Device Dissipation<br>$T_A = 25^\circ\text{C}$ (Note 1)<br>(Note 2)<br>Derate above $25^\circ\text{C}$ (Note 1)<br>(Note 2) | $P_D$           | 250<br>385<br>2.0<br>3.0 | mW<br><br>mW/ $^\circ\text{C}$ |
| Thermal Resistance,<br>Junction to Ambient (Note 1)<br>(Note 2)   | $R_{\theta JA}$ | 493<br>325               | $^\circ\text{C/W}$             |
| Thermal Resistance,<br>Junction to Lead (Note 1)<br>(Note 2)  | $R_{\theta JL}$ | 188<br>208               | $^\circ\text{C/W}$             |
| Junction and Storage Temperature Range  | $T_J, T_{stg}$  | -55 to +150              | $^\circ\text{C}$               |

### NSBC114EDXV6 (SOT-563) ONE JUNCTION HEATED

|   |                 |            |                            |
|---|-----------------|------------|----------------------------|
| Total Device Dissipation<br>$T_A = 25^\circ\text{C}$ (Note 1)<br>Derate above $25^\circ\text{C}$ (Note 1) | $P_D$           | 357<br>2.9 | mW<br>mW/ $^\circ\text{C}$ |
| Thermal Resistance,<br>Junction to Ambient (Note 1)   | $R_{\theta JA}$ | 350        | $^\circ\text{C/W}$         |

### NSBC114EDXV6 (SOT-563) BOTH JUNCTION HEATED (Note 3)

|   |                 |             |                            |
|---|-----------------|-------------|----------------------------|
| Total Device Dissipation<br>$T_A = 25^\circ\text{C}$ (Note 1)<br>Derate above $25^\circ\text{C}$ (Note 1) | $P_D$           | 500<br>4.0  | mW<br>mW/ $^\circ\text{C}$ |
| Thermal Resistance,<br>Junction to Ambient (Note 1)   | $R_{\theta JA}$ | 250         | $^\circ\text{C/W}$         |
| Junction and Storage Temperature Range  | $T_J, T_{stg}$  | -55 to +150 | $^\circ\text{C}$           |

### NSBC114EDP6 (SOT-963) ONE JUNCTION HEATED

|   |                 |                          |                                |
|---|-----------------|--------------------------|--------------------------------|
| Total Device Dissipation<br>$T_A = 25^\circ\text{C}$ (Note 4)<br>(Note 5)<br>Derate above $25^\circ\text{C}$ (Note 4)<br>(Note 5) | $P_D$           | 231<br>269<br>1.9<br>2.2 | MW<br><br>mW/ $^\circ\text{C}$ |
| Thermal Resistance,<br>Junction to Ambient (Note 4)<br>(Note 5)   | $R_{\theta JA}$ | 540<br>464               | $^\circ\text{C/W}$             |

### NSBC114EDP6 (SOT-963) BOTH JUNCTION HEATED (Note 3)

|   |                 |                          |                                |
|---|-----------------|--------------------------|--------------------------------|
| Total Device Dissipation<br>$T_A = 25^\circ\text{C}$ (Note 4)<br>(Note 5)<br>Derate above $25^\circ\text{C}$ (Note 4)<br>(Note 5) | $P_D$           | 339<br>408<br>2.7<br>3.3 | MW<br><br>mW/ $^\circ\text{C}$ |
| Thermal Resistance,<br>Junction to Ambient (Note 4)<br>(Note 5)   | $R_{\theta JA}$ | 369<br>306               | $^\circ\text{C/W}$             |
| Junction and Storage Temperature Range  | $T_J, T_{stg}$  | -55 to +150              | $^\circ\text{C}$               |

1. FR-4 @ Minimum Pad.
2. FR-4 @ 1.0 x 1.0 Inch Pad.
3. Both junction heated values assume total power is sum of two equally powered channels.
4. FR-4 @ 100 mm<sup>2</sup>, 1 oz. copper traces, still air.
5. FR-4 @ 500 mm<sup>2</sup>, 1 oz. copper traces, still air.

# MUN5211DW1, NSBC114EDXV6, NSBC114EDP6

## ELECTRICAL CHARACTERISTICS ( $T_A = 25^\circ\text{C}$ , common for $Q_1$ and $Q_2$ , unless otherwise noted)

| Characteristic  | Symbol        | Min | Typ | Max | Unit |
|---|---------------|-----|-----|-----|------|
| <b>OFF CHARACTERISTICS</b>  |               |     |     |     |      |
| Collector-Base Cutoff Current<br>( $V_{CB} = 50\text{ V}$ , $I_E = 0$ )               | $I_{CBO}$     | -   | -   | 100 | nAdc |
| Collector-Emitter Cutoff Current<br>( $V_{CE} = 50\text{ V}$ , $I_B = 0$ )            | $I_{CEO}$     | -   | -   | 500 | nAdc |
| Emitter-Base Cutoff Current<br>( $V_{EB} = 6.0\text{ V}$ , $I_C = 0$ )                | $I_{EBO}$     | -   | -   | 0.5 | mAdc |
| Collector-Base Breakdown Voltage<br>( $I_C = 10\ \mu\text{A}$ , $I_E = 0$ )           | $V_{(BR)CBO}$ | 50  | -   | -   | Vdc  |
| Collector-Emitter Breakdown Voltage (Note 6)<br>( $I_C = 2.0\text{ mA}$ , $I_B = 0$ ) | $V_{(BR)CEO}$ | 50  | -   | -   | Vdc  |

## ON CHARACTERISTICS

|   |               |     |     |      |            |
|---|---------------|-----|-----|------|------------|
| DC Current Gain (Note 6)<br>( $I_C = 5.0\text{ mA}$ , $V_{CE} = 10\text{ V}$ )                          | $h_{FE}$      | 35  | 60  | -    |            |
| Collector-Emitter Saturation Voltage (Note 6)<br>( $I_C = 10\text{ mA}$ , $I_B = 0.3\text{ mA}$ )       | $V_{CE(sat)}$ | -   | -   | 0.25 | V          |
| Input Voltage (Off)<br>( $V_{CE} = 5.0\text{ V}$ , $I_C = 100\ \mu\text{A}$ )                           | $V_{i(off)}$  | -   | 1.2 | -    | Vdc        |
| Input Voltage (On)<br>( $V_{CE} = 0.2\text{ V}$ , $I_C = 10\text{ mA}$ )                                | $V_{i(on)}$   | -   | 2.0 | -    | Vdc        |
| Output Voltage (On)<br>( $V_{CC} = 5.0\text{ V}$ , $V_B = 2.5\text{ V}$ , $R_L = 1.0\text{ k}\Omega$ )  | $V_{OL}$      | -   | -   | 0.2  | Vdc        |
| Output Voltage (Off)<br>( $V_{CC} = 5.0\text{ V}$ , $V_B = 0.5\text{ V}$ , $R_L = 1.0\text{ k}\Omega$ ) | $V_{OH}$      | 4.9 | -   | -    | Vdc        |
| Input Resistor  | R1            | 7.0 | 10  | 13   | k $\Omega$ |
| Resistor Ratio  | $R_1/R_2$     | 0.8 | 1.0 | 1.2  |            |

Product parametric performance is indicated in the Electrical Characteristics for the listed test conditions, unless otherwise noted. Product performance may not be indicated by the Electrical Characteristics if operated under different conditions.

6. Pulsed Condition: Pulse Width = 300 ms, Duty Cycle  $\leq$  2%.

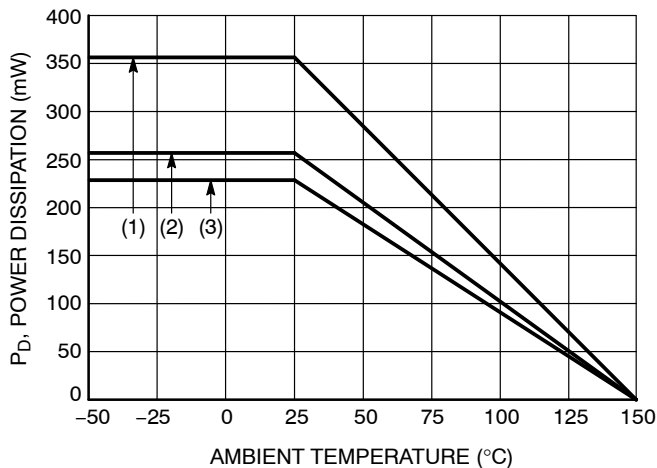

- (1) SOT-363; 1.0 × 1.0 Inch Pad
- (2) SOT-563; Minimum Pad
- (3) SOT-963; 100 mm<sup>2</sup>, 1 oz. Copper Trace

Figure 1. Derating Curve

TYPICAL CHARACTERISTICS  
MUN5211DW1, NSBC114EDXV6

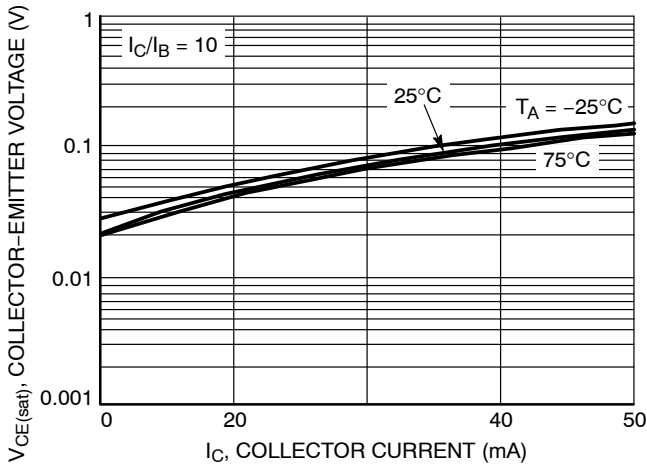

Figure 2.  $V_{CE(sat)}$  vs.  $I_C$

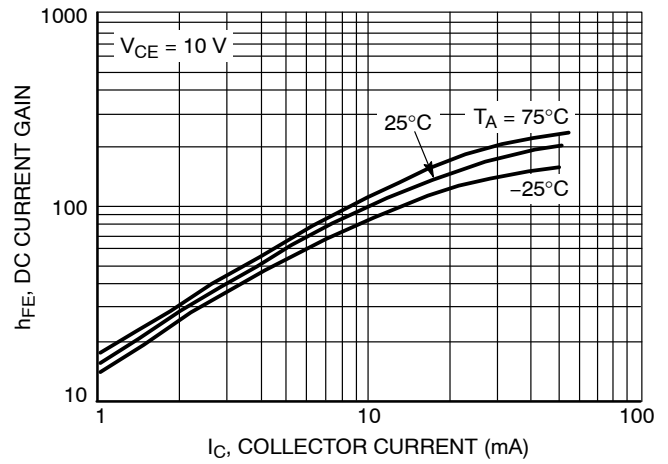

Figure 3. DC Current Gain

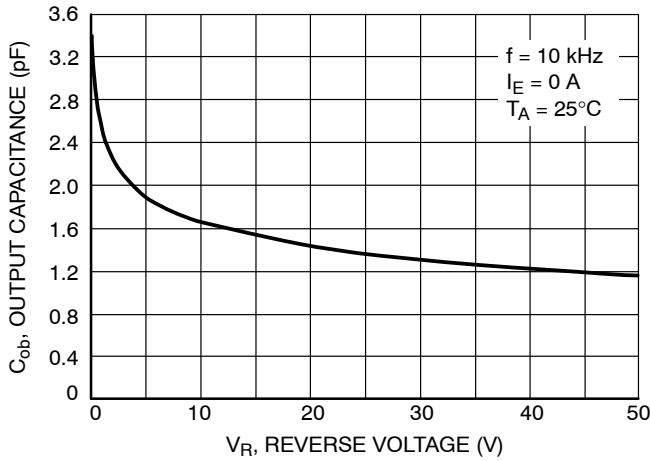

Figure 4. Output Capacitance

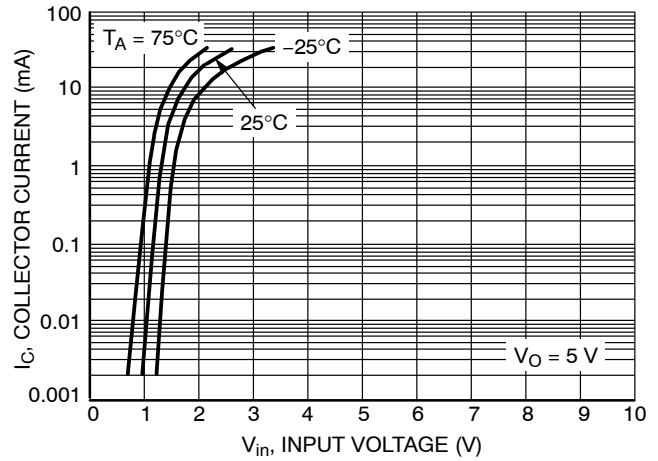

Figure 5. Output Current vs. Input Voltage

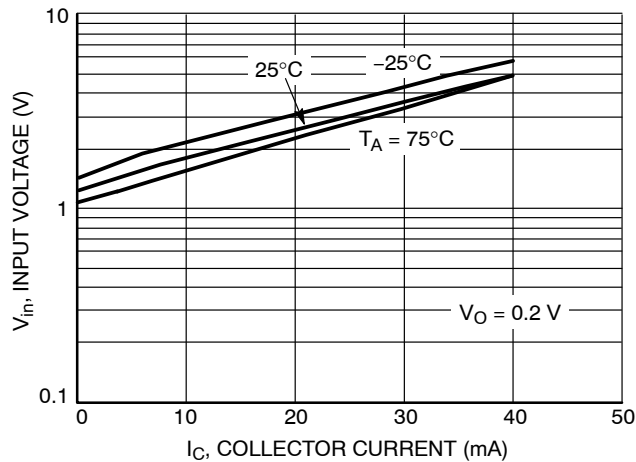

Figure 6. Input Voltage vs. Output Current

TYPICAL CHARACTERISTICS  
NSBC114EDP6

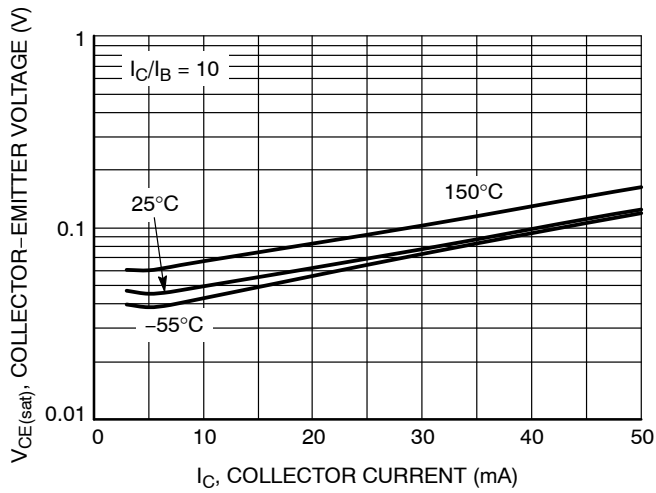

Figure 7.  $V_{CE(sat)}$  vs.  $I_C$

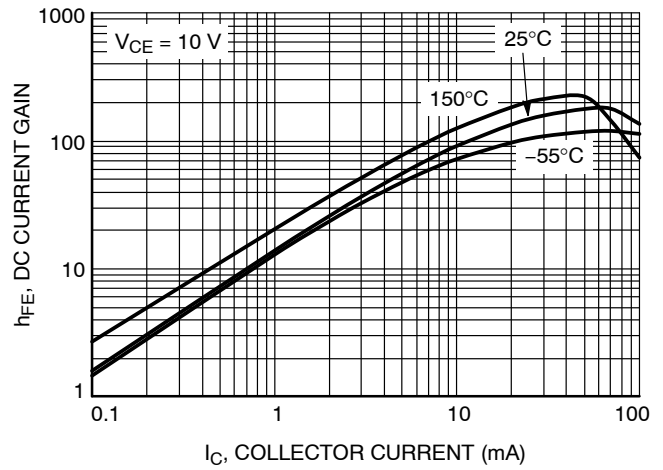

Figure 8. DC Current Gain

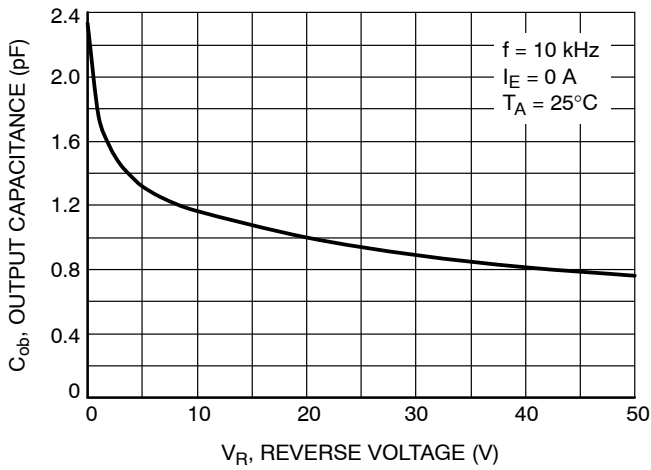

Figure 9. Output Capacitance

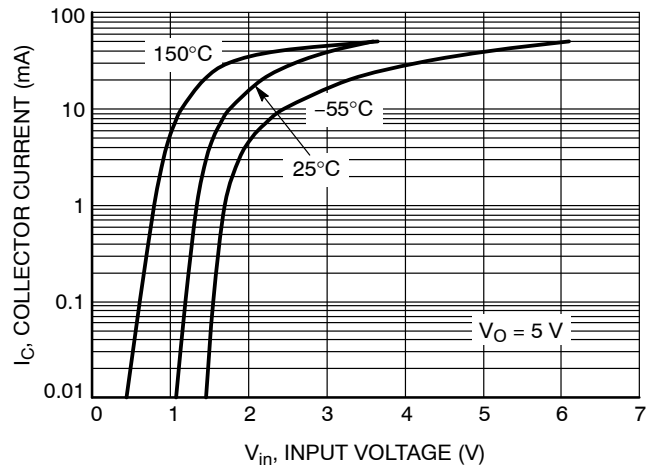

Figure 10. Output Current vs. Input Voltage

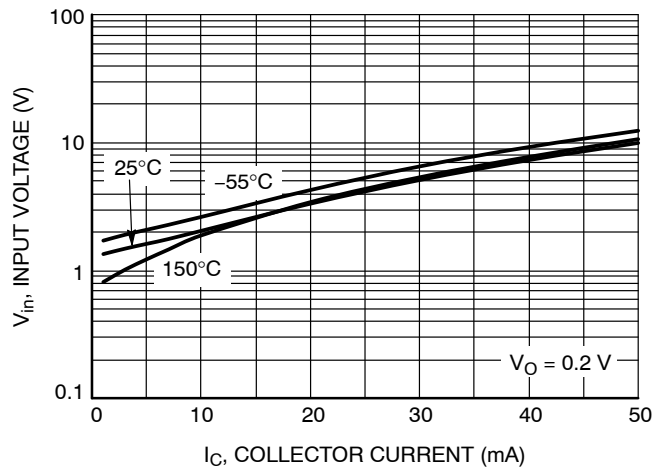
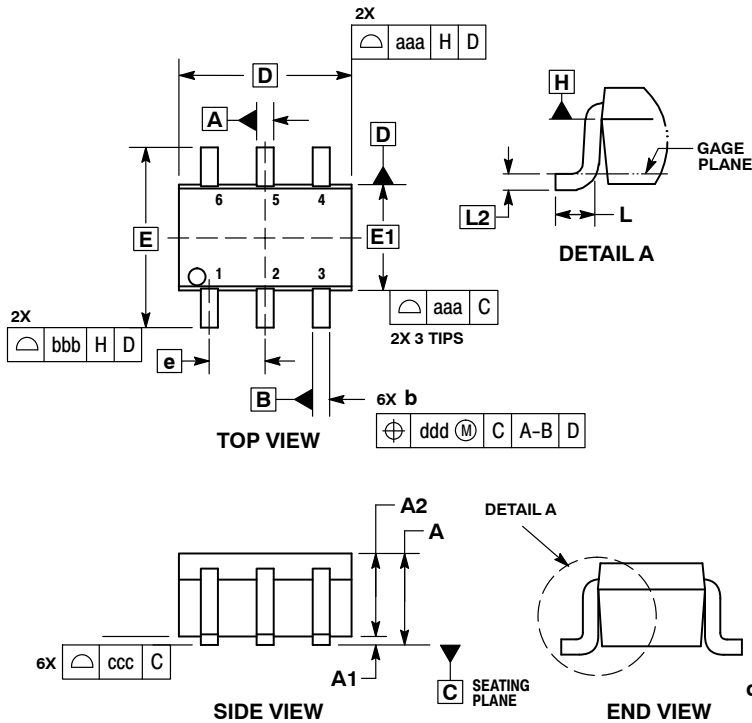

Figure 11. Input Voltage vs. Output Current

# MUN5211DW1, NSBC114EDXV6, NSBC114EDP6

## PACKAGE DIMENSIONS

SC-88/SC70-6/SOT-363  
CASE 419B-02  
ISSUE Y



**NOTES:**

1. DIMENSIONING AND TOLERANCING PER ASME Y14.5M, 1994.
2. CONTROLLING DIMENSION: MILLIMETERS.
3. DIMENSIONS D AND E1 DO NOT INCLUDE MOLD FLASH, PROTRUSIONS, OR GATE BURRS. MOLD FLASH, PROTRUSIONS, OR GATE BURRS SHALL NOT EXCEED 0.20 PER END.
4. DIMENSIONS D AND E1 AT THE OUTERMOST EXTREMES OF THE PLASTIC BODY AND DATUM H.
5. DATUMS A AND B ARE DETERMINED AT DATUM H.
6. DIMENSIONS b AND c APPLY TO THE FLAT SECTION OF THE LEAD BETWEEN 0.08 AND 0.15 FROM THE TIP.
7. DIMENSION b DOES NOT INCLUDE DAMBAR PROTRUSION. ALLOWABLE DAMBAR PROTRUSION SHALL BE 0.08 TOTAL IN EXCESS OF DIMENSION b AT MAXIMUM MATERIAL CONDITION. THE DAMBAR CANNOT BE LOCATED ON THE LOWER RADIUS OF THE FOOT.

| DIM | MILLIMETERS |      |      | INCHES    |       |       |
|-----|-------------|------|------|-----------|-------|-------|
|     | MIN         | NOM  | MAX  | MIN       | NOM   | MAX   |
| A   | ---         | ---  | 1.10 | ---       | ---   | 0.043 |
| A1  | 0.00        | ---  | 0.10 | 0.000     | ---   | 0.004 |
| A2  | 0.70        | 0.90 | 1.00 | 0.027     | 0.035 | 0.039 |
| b   | 0.15        | 0.20 | 0.25 | 0.006     | 0.008 | 0.010 |
| C   | 0.08        | 0.15 | 0.22 | 0.003     | 0.006 | 0.009 |
| D   | 1.80        | 2.00 | 2.20 | 0.070     | 0.078 | 0.086 |
| E   | 2.00        | 2.10 | 2.20 | 0.078     | 0.082 | 0.086 |
| E1  | 1.15        | 1.25 | 1.35 | 0.045     | 0.049 | 0.053 |
| e   | 0.65 BSC    |      |      | 0.026 BSC |       |       |
| L   | 0.26        | 0.36 | 0.46 | 0.010     | 0.014 | 0.018 |
| L2  | 0.15 BSC    |      |      | 0.006 BSC |       |       |
| aaa | 0.15        |      |      | 0.006     |       |       |
| bbb | 0.30        |      |      | 0.012     |       |       |
| ccc | 0.10        |      |      | 0.004     |       |       |
| ddd | 0.10        |      |      | 0.004     |       |       |

### RECOMMENDED SOLDERING FOOTPRINT\*

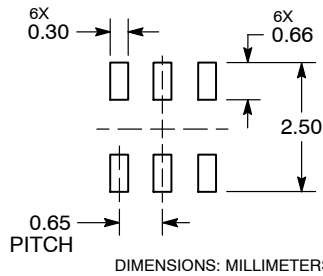

\*For additional information on our Pb-Free strategy and soldering details, please download the ON Semiconductor Soldering and Mounting Techniques Reference Manual, SOLDERRM/D.

# MUN5211DW1, NSBC114EDXV6, NSBC114EDP6

## PACKAGE DIMENSIONS

### SOT-563, 6 LEAD CASE 463A ISSUE G

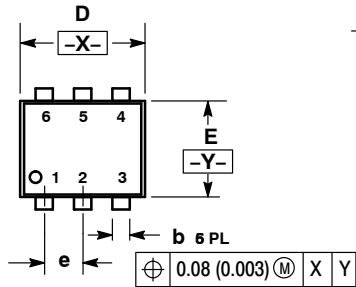

- NOTES:
1. DIMENSIONING AND TOLERANCING PER ANSI Y14.5M, 1982.
  2. CONTROLLING DIMENSION: MILLIMETERS
  3. MAXIMUM LEAD THICKNESS INCLUDES LEAD FINISH THICKNESS. MINIMUM LEAD THICKNESS IS THE MINIMUM THICKNESS OF BASE MATERIAL.

| DIM | MILLIMETERS |      |      | INCHES   |       |       |
|-----|-------------|------|------|----------|-------|-------|
|     | MIN         | NOM  | MAX  | MIN      | NOM   | MAX   |
| A   | 0.50        | 0.55 | 0.60 | 0.020    | 0.021 | 0.023 |
| b   | 0.17        | 0.22 | 0.27 | 0.007    | 0.009 | 0.011 |
| C   | 0.08        | 0.12 | 0.18 | 0.003    | 0.005 | 0.007 |
| D   | 1.50        | 1.60 | 1.70 | 0.059    | 0.062 | 0.066 |
| E   | 1.10        | 1.20 | 1.30 | 0.043    | 0.047 | 0.051 |
| e   | 0.5 BSC     |      |      | 0.02 BSC |       |       |
| L   | 0.10        | 0.20 | 0.30 | 0.004    | 0.008 | 0.012 |
| HE  | 1.50        | 1.60 | 1.70 | 0.059    | 0.062 | 0.066 |

### SOLDERING FOOTPRINT\*

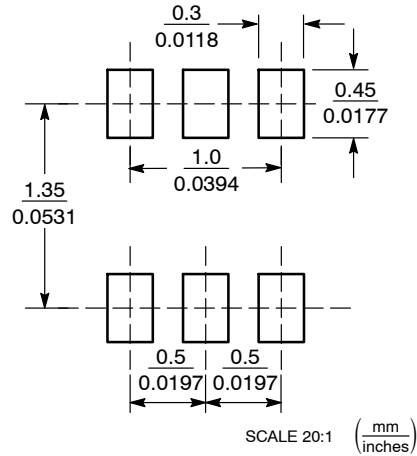

SCALE 20:1 ( $\frac{\text{mm}}{\text{inches}}$ )

\*For additional information on our Pb-Free strategy and soldering details, please download the ON Semiconductor Soldering and Mounting Techniques Reference Manual, SOLDERRM/D.

# MUN5211DW1, NSBC114EDXV6, NSBC114EDP6

## PACKAGE DIMENSIONS

**SOT-963**  
CASE 527AD  
ISSUE E

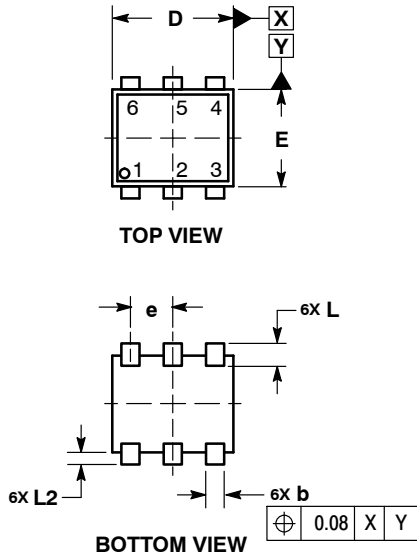

**NOTES:**

1. DIMENSIONING AND TOLERANCING PER ASME Y14.5M, 1994.
2. CONTROLLING DIMENSION: MILLIMETERS
3. MAXIMUM LEAD THICKNESS INCLUDES LEAD FINISH THICKNESS. MINIMUM LEAD THICKNESS IS THE MINIMUM THICKNESS OF BASE MATERIAL.
4. DIMENSIONS D AND E DO NOT INCLUDE MOLD FLASH, PROTRUSIONS, OR GATE BURRS.

| DIM | MILLIMETERS |      |      |
|-----|-------------|------|------|
|     | MIN         | NOM  | MAX  |
| A   | 0.34        | 0.37 | 0.40 |
| b   | 0.10        | 0.15 | 0.20 |
| C   | 0.07        | 0.12 | 0.17 |
| D   | 0.95        | 1.00 | 1.05 |
| E   | 0.75        | 0.80 | 0.85 |
| e   | 0.35 BSC    |      |      |
| He  | 0.95        | 1.00 | 1.05 |
| L   | 0.19 REF    |      |      |
| L2  | 0.05        | 0.10 | 0.15 |

### RECOMMENDED MOUNTING FOOTPRINT\*

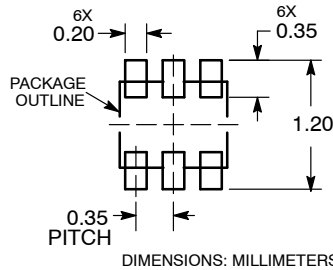

\*For additional information on our Pb-Free strategy and soldering details, please download the ON Semiconductor Soldering and Mounting Techniques Reference Manual, SOLDERRM/D.

ON Semiconductor and are trademarks of Semiconductor Components Industries, LLC dba ON Semiconductor or its subsidiaries in the United States and/or other countries. ON Semiconductor owns the rights to a number of patents, trademarks, copyrights, trade secrets, and other intellectual property. A listing of ON Semiconductor's product/patent coverage may be accessed at [www.onsemi.com/site/pdf/Patent-Marking.pdf](http://www.onsemi.com/site/pdf/Patent-Marking.pdf). ON Semiconductor reserves the right to make changes without further notice to any products herein. ON Semiconductor makes no warranty, representation or guarantee regarding the suitability of its products for any particular purpose, nor does ON Semiconductor assume any liability arising out of the application or use of any product or circuit, and specifically disclaims any and all liability, including without limitation special, consequential or incidental damages. Buyer is responsible for its products and applications using ON Semiconductor products, including compliance with all laws, regulations and safety requirements or standards, regardless of any support or applications information provided by ON Semiconductor. "Typical" parameters which may be provided in ON Semiconductor data sheets and/or specifications can and do vary in different applications and actual performance may vary over time. All operating parameters, including "Typicals" must be validated for each customer application by customer's technical experts. ON Semiconductor does not convey any license under its patent rights nor the rights of others. ON Semiconductor products are not designed, intended, or authorized for use as a critical component in life support systems or any FDA Class 3 medical devices or medical devices with a same or similar classification in a foreign jurisdiction or any devices intended for implantation in the human body. Should Buyer purchase or use ON Semiconductor products for any such unintended or unauthorized application, Buyer shall indemnify and hold ON Semiconductor and its officers, employees, subsidiaries, affiliates, and distributors harmless against all claims, costs, damages, and expenses, and reasonable attorney fees arising out of, directly or indirectly, any claim of personal injury or death associated with such unintended or unauthorized use, even if such claim alleges that ON Semiconductor was negligent regarding the design or manufacture of the part. ON Semiconductor is an Equal Opportunity/Affirmative Action Employer. This literature is subject to all applicable copyright laws and is not for resale in any manner.

### PUBLICATION ORDERING INFORMATION

**LITERATURE FULFILLMENT:**  
Literature Distribution Center for ON Semiconductor  
19521 E. 32nd Pkwy, Aurora, Colorado 80011 USA  
**Phone:** 303-675-2175 or 800-344-3860 Toll Free USA/Canada  
**Fax:** 303-675-2176 or 800-344-3867 Toll Free USA/Canada  
**Email:** [orderlit@onsemi.com](mailto:orderlit@onsemi.com)

**N. American Technical Support:** 800-282-9855 Toll Free  
USA/Canada  
**Europe, Middle East and Africa Technical Support:**  
Phone: 421 33 790 2910  
**Japan Customer Focus Center**  
Phone: 81-3-5817-1050

**ON Semiconductor Website:** [www.onsemi.com](http://www.onsemi.com)  
**Order Literature:** <http://www.onsemi.com/orderlit>

For additional information, please contact your local Sales Representative



# Mouser Electronics

Authorized Distributor

Click to View Pricing, Inventory, Delivery & Lifecycle Information:

[ON Semiconductor:](#)

[NSBC114EDXV6T1G](#) [SMUN5211DW1T1G](#)