

THIS IS A C.A.D. GENERATED DRAWING
DO NOT MAKE MANUAL REVISIONS TO MASTER.

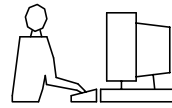

* UNLESS OTHERWISE SPECIFIED TOLERANCES
ON DECIMAL IS:

BACKSHELL KIT INCLUDES:

- (1)BACKSHELL
 - (2)4-40 THUMBSCREWS
 - (1)PLASTIC STRAIN RELIEF
 - (1)METAL STRAIN RELIEF CLAMP
 - (2)STRAIN RELIEF SCREWS
- TORQUE VALUE ON PLASTIC FOR STRAIN RELIEF SCREWS=4 INCH POUNDS MAX

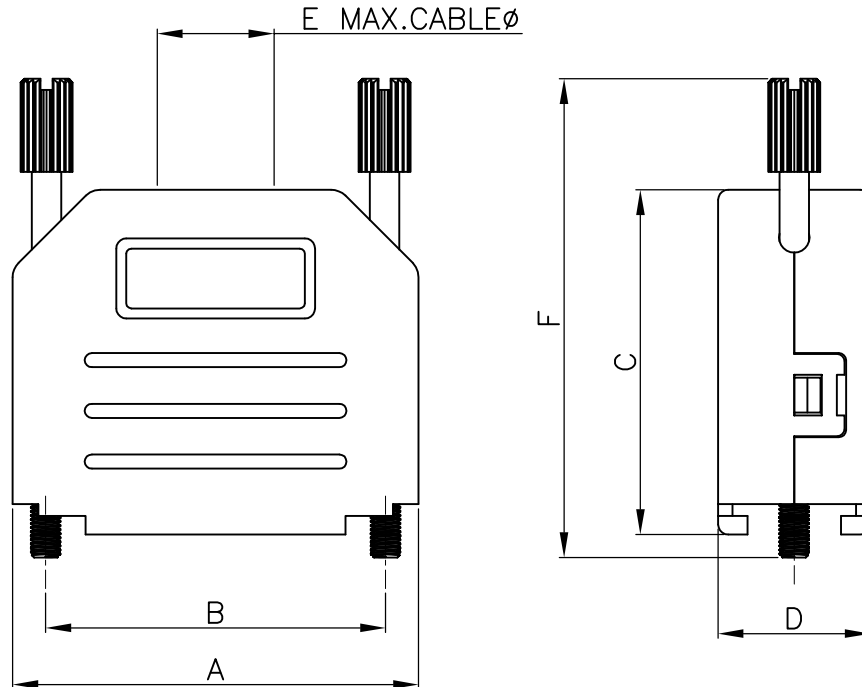

DIMENSIONS(mm/in)						
SIZE	A ± 0.032	B ± 0.012	C ± 0.02	D ± 0.02	E	F ± 0.02
15	40.00	33.32	34.00	15.00	11.50	47.20
	1.575	1.312	1.339	0.591	0.453	1.858

ORDERING INFORMATION: (YY=COLOR)

SIZE	P/N-KITTED:	P/N-BULK:
15-WAY	MHDPPK15-YY-K	MHDPPK15-YY

COLOR CODE CHART:

- BLACK = BK
- LIGHT GREY = LG
- DEC GREY = DE
- RED = R
- BLUE = B
- YELLOW = Y
- GREEN = G
- WHITE = W

MATERIAL: POLYAMIDE PA66-UL RECOGNIZED MATERIAL
SEE COLOR CODE CHART.

THUMBSCREWS: STEEL,BLACK OXIDE(FOR BLACK HOODS)
STEEL,Zn PLATED(FOR COLORED HOODS)

OPERATING TEMP: -55°C TO+110°C .



THIS SERIES FULLY CONFORMS TO THE
EUROPEAN UNION DIRECTIVES 2002/95/EC
AND 2002/96/EC FOR RoHS COMPLIANCY.



**MH CONNECTORS ,
DIVISION OF EDAC**

THESE DRAWINGS AND SPECIFICATIONS ARE THE
PROPERTY OF MH CONNECTORS AND SHALL NOT BE
REPRODUCED, COPIED OR USED AS THE BASIS FOR
THE MANUFACTURE OR SALE OF APPARATUS WITHOUT
WRITTEN PERMISSION.

DRAWN HALEY		DATE 06-24-15
APPROVED DAMIEN		DATE 06-30-15
SCALE NTS	SHEET OF 1 OF 1	REV: 2.0
DRAWING No MHDPPK15-SLIM SERIES		

THIS IS A C.A.D. GENERATED DRAWING
DO NOT MAKE MANUAL REVISIONS TO MASTER.

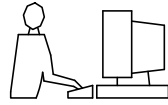

* UNLESS OTHERWISE SPECIFIED TOLERANCES
ON DECIMAL IS: ANGLE $\pm 1^\circ$
.X ± 0.20
.XX ± 0.15
.XXX ± 0.05

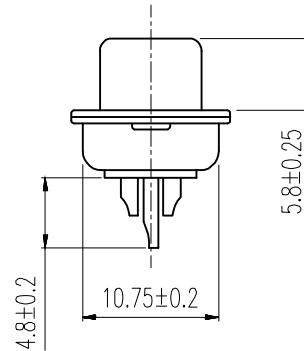
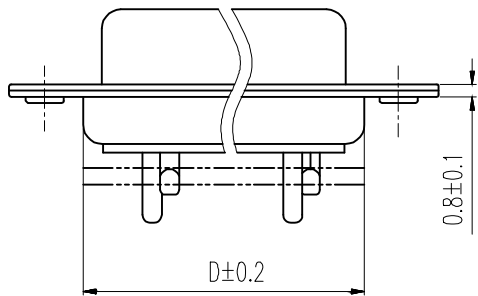
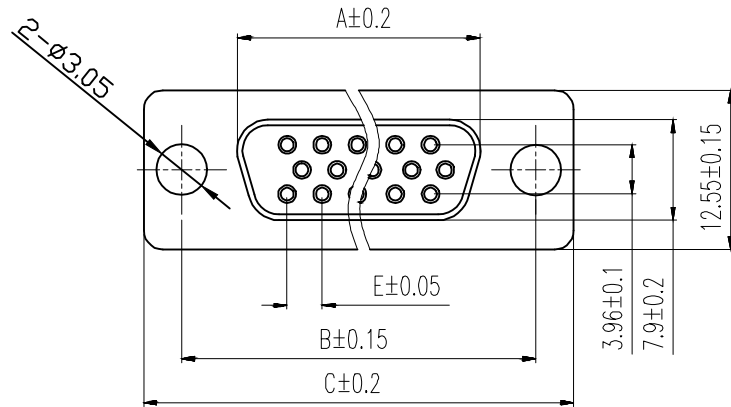

Order Codes:

Socket Connector

Stamped & Formed

15-WAY	MHHDS-15-F-N-B-S
26-WAY	MHHDS-26-F-N-B-S
44-WAY	MHHDS-44-F-N-B-S
62-WAY	MHHDS-62-F-N-B-S

POS.	A	B	C	D	E
15	16.33	24.99	30.80	19.28	2.29
26	24.85	33.32	39.10	27.75	2.29
44	38.38	47.04	53.00	41.30	2.29
62	54.86	63.50	69.30	57.40	2.41

Remark:

1.MATERIAL:

Plastic:PBT+30% G.F (UL94V-0) BLACK

Spcc shell:Spcc front shell is nickel plated back shell is nickel plated

THESE DRAWINGS AND SPECIFICATIONS ARE THE PROPERTY OF MH CONNECTORS AND SHALL NOT BE REPRODUCED, COPIED OR USED AS THE BASIS FOR THE MANUFACTURE OR SALE OF APPARATUS WITHOUT WRITTEN PERMISSION.

DRAWN
IVEN Ou
DATE
08-18-22

APPROVED
DATE

SCALE
1 : 1
SHEET OF
1 OF 1
REV:
2.0

DRAWING No
MHHDS-XX-F-N-B-S



THIS SERIES FULLY CONFORMS TO THE EUROPEAN UNION DIRECTIVES 2002/95/EC AND 2002/96/EC FOR RoHS COMPLIANCY.



MH CONNECTORS,
DIVISION OF EDAC