



Is Now Part of



ON Semiconductor®

To learn more about ON Semiconductor, please visit our website at
www.onsemi.com

Please note: As part of the Fairchild Semiconductor integration, some of the Fairchild orderable part numbers will need to change in order to meet ON Semiconductor's system requirements. Since the ON Semiconductor product management systems do not have the ability to manage part nomenclature that utilizes an underscore (_), the underscore (_) in the Fairchild part numbers will be changed to a dash (-). This document may contain device numbers with an underscore (_). Please check the ON Semiconductor website to verify the updated device numbers. The most current and up-to-date ordering information can be found at www.onsemi.com. Please email any questions regarding the system integration to Fairchild_questions@onsemi.com.

ON Semiconductor and the ON Semiconductor logo are trademarks of Semiconductor Components Industries, LLC dba ON Semiconductor or its subsidiaries in the United States and/or other countries. ON Semiconductor owns the rights to a number of patents, trademarks, copyrights, trade secrets, and other intellectual property. A listing of ON Semiconductor's product/patent coverage may be accessed at www.onsemi.com/site/pdf/Patent-Marking.pdf. ON Semiconductor reserves the right to make changes without further notice to any products herein. ON Semiconductor makes no warranty, representation or guarantee regarding the suitability of its products for any particular purpose, nor does ON Semiconductor assume any liability arising out of the application or use of any product or circuit, and specifically disclaims any and all liability, including without limitation special, consequential or incidental damages. Buyer is responsible for its products and applications using ON Semiconductor products, including compliance with all laws, regulations and safety requirements or standards, regardless of any support or applications information provided by ON Semiconductor. "Typical" parameters which may be provided in ON Semiconductor data sheets and/or specifications can and do vary in different applications and actual performance may vary over time. All operating parameters, including "Typicals" must be validated for each customer application by customer's technical experts. ON Semiconductor does not convey any license under its patent rights nor the rights of others. ON Semiconductor products are not designed, intended, or authorized for use as a critical component in life support systems or any FDA Class 3 medical devices or medical devices with a same or similar classification in a foreign jurisdiction or any devices intended for implantation in the human body. Should Buyer purchase or use ON Semiconductor products for any such unintended or unauthorized application, Buyer shall indemnify and hold ON Semiconductor and its officers, employees, subsidiaries, affiliates, and distributors harmless against all claims, costs, damages, and expenses, and reasonable attorney fees arising out of, directly or indirectly, any claim of personal injury or death associated with such unintended or unauthorized use, even if such claim alleges that ON Semiconductor was negligent regarding the design or manufacture of the part. ON Semiconductor is an Equal Opportunity/Affirmative Action Employer. This literature is subject to all applicable copyright laws and is not for resale in any manner.

FDY3000NZ

Dual N-Channel 2.5V Specified PowerTrench® MOSFET

General Description

This Dual N-Channel MOSFET has been designed using Fairchild Semiconductor's advanced PowerTrench process to optimize the $R_{DS(ON)}$ @ $V_{GS} = 2.5V$.

Applications

- Li-Ion Battery Pack



Features

- 600 mA, 20 V $R_{DS(ON)} = 700\text{ m}\Omega$ @ $V_{GS} = 4.5\text{ V}$
 $R_{DS(ON)} = 850\text{ m}\Omega$ @ $V_{GS} = 2.5\text{ V}$
- ESD protection diode (note 3)
- RoHS Compliant

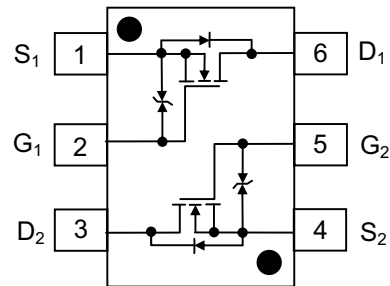
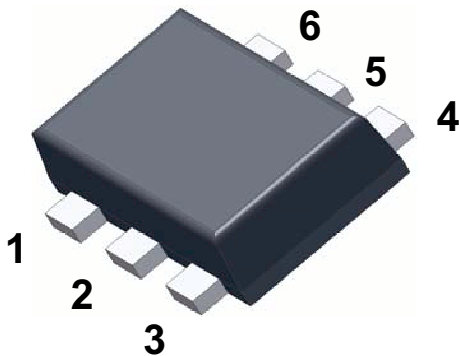

Absolute Maximum Ratings T_A=25°C unless otherwise noted

| Symbol | Parameter | Ratings | Units |
|----------------|--|-------------|-------|
| V_{DSS} | Drain-Source Voltage | 20 | V |
| V_{GSS} | Gate-Source Voltage | ± 12 | V |
| I_D | Drain Current – Continuous (Note 1a) | 600 | mA |
| | | 1000 | |
| P_D | Power Dissipation (Steady State) (Note 1a) | 625 | mW |
| | | 446 | |
| T_J, T_{STG} | Operating and Storage Junction Temperature Range | -55 to +150 | °C |

Thermal Characteristics

| | | | |
|-----------------|---|-----|------|
| $R_{\theta JA}$ | Thermal Resistance, Junction-to-Ambient (Note 1a) | 200 | °C/W |
| $R_{\theta JA}$ | Thermal Resistance, Junction-to-Ambient (Note 1b) | 280 | |

Package Marking and Ordering Information

| Device Marking | Device | Reel Size | Tape width | Quantity |
|----------------|-----------|-----------|------------|------------|
| C | FDY3000NZ | 7" | 8 mm | 3000 units |

Electrical Characteristics

$T_A = 25^\circ\text{C}$ unless otherwise noted

| Symbol | Parameter | Test Conditions | Min | Typ | Max | Units |
|--------|-----------|-----------------|-----|-----|-----|-------|
|--------|-----------|-----------------|-----|-----|-----|-------|

Off Characteristics

| | | | | | | |
|--------------------------------------|---|---|----|----|----------|---------------|
| BV_{DSS} | Drain-Source Breakdown Voltage | $V_{GS} = 0\text{ V}, I_D = 250\ \mu\text{A}$ | 20 | | | V |
| $\frac{\Delta BV_{DSS}}{\Delta T_J}$ | Breakdown Voltage Temperature Coefficient | $I_D = 250\ \mu\text{A}$, Referenced to 25°C | | 14 | | mV/°C |
| I_{DSS} | Zero Gate Voltage Drain Current | $V_{DS} = 16\text{ V}, V_{GS} = 0\text{ V}$ | | | 1 | μA |
| I_{GSS} | Gate-Body Leakage, | $V_{GS} = \pm 12\text{ V}, V_{DS} = 0\text{ V}$ | | | ± 10 | μA |
| | | $V_{GS} = \pm 4.5\text{ V}, V_{DS} = 0\text{ V}$ | | | ± 1 | μA |

On Characteristics (Note 2)

| | | | | | | |
|--|--|---|-----|------|------|----------|
| $V_{GS(th)}$ | Gate Threshold Voltage | $V_{DS} = V_{GS}, I_D = 250\ \mu\text{A}$ | 0.6 | 1.0 | 1.3 | V |
| $\frac{\Delta V_{GS(th)}}{\Delta T_J}$ | Gate Threshold Voltage Temperature Coefficient | $I_D = 250\ \mu\text{A}$, Referenced to 25°C | | -3 | | mV/°C |
| $R_{DS(on)}$ | Static Drain-Source On-Resistance | $V_{GS} = 4.5\text{ V}, I_D = 600\text{ mA}$ | | 0.25 | 0.70 | Ω |
| | | $V_{GS} = 2.5\text{ V}, I_D = 500\text{ mA}$ | | 0.37 | 0.85 | |
| | | $V_{GS} = 1.8\text{ V}, I_D = 150\text{ mA}$ | | 0.73 | 1.25 | |
| | | $V_{GS} = 4.5\text{ V}, I_D = 600\text{ mA}, T_J = 125^\circ\text{C}$ | | 0.35 | 1.00 | |
| g_{FS} | Forward Transconductance | $V_{DS} = 5\text{ V}, I_D = 600\text{ mA}$ | | 1.8 | | S |

Dynamic Characteristics

| | | | | | | |
|-----------|------------------------------|--|--|----|--|----|
| C_{iss} | Input Capacitance | $V_{DS} = 10\text{ V}, V_{GS} = 0\text{ V},$ $f = 1.0\text{ MHz}$ | | 60 | | pF |
| C_{oss} | Output Capacitance | | | 20 | | pF |
| C_{rss} | Reverse Transfer Capacitance | | | 10 | | pF |

Switching Characteristics (Note 2)

| | | | | | | |
|--------------|---------------------|---|--|------|-----|----|
| $t_{d(on)}$ | Turn-On Delay Time | $V_{DD} = 10\text{ V}, I_D = 1\text{ A},$ $V_{GS} = 4.5\text{ V}, R_{GEN} = 6\ \Omega$ | | 6 | 12 | ns |
| t_r | Turn-On Rise Time | | | 8 | 16 | ns |
| $t_{d(off)}$ | Turn-Off Delay Time | | | 8 | 16 | ns |
| t_f | Turn-Off Fall Time | | | 2.4 | 4.8 | ns |
| Q_g | Total Gate Charge | $V_{DS} = 10\text{ V}, I_D = 600\text{ mA},$ $V_{GS} = 4.5\text{ V}$ | | 0.8 | 1.1 | nC |
| Q_{gs} | Gate-Source Charge | | | 0.16 | | nC |
| Q_{gd} | Gate-Drain Charge | | | 0.26 | | nC |

Drain-Source Diode Characteristics and Maximum Ratings

| | | | | | | |
|----------|------------------------------------|---|--|-----|-----|----|
| V_{SD} | Drain-Source Diode Forward Voltage | $V_{GS} = 0\text{ V}, I_S = 150\text{ mA}$ (Note 2) | | 0.7 | 1.2 | V |
| t_{rr} | Diode Reverse Recovery Time | $I_F = 600\text{ mA},$ | | 8 | | ns |
| Q_{rr} | Diode Reverse Recovery Charge | $di_F/dt = 100\text{ A}/\mu\text{s}$ | | 1 | | nC |

Notes:

- $R_{\theta JA}$ is the sum of the junction-to-case and case-to-ambient thermal resistance where the case thermal reference is defined as the solder mounting surface of the drain pins. $R_{\theta JC}$ is guaranteed by design while $R_{\theta CA}$ is determined by the user's board design



- a) 200°C/W when mounted on a 1 in^2 pad of 2 oz copper

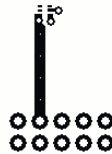

- b) 280°C/W when mounted on a minimum pad of 2 oz copper
Scale 1 : 1 on letter size paper

- Pulse Test: Pulse Width < 300 μs , Duty Cycle < 2.0%

- The diode connected between the gate and source serves only as protection against ESD. No gate overvoltage rating is implied.

Typical Characteristics

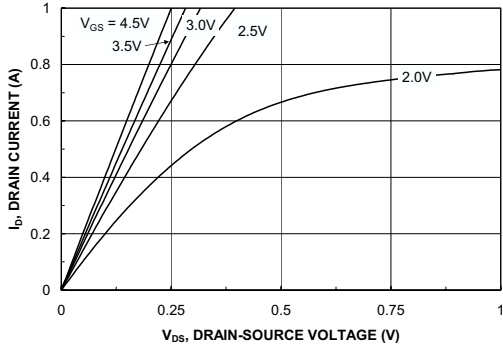

Figure 1. On-Region Characteristics.

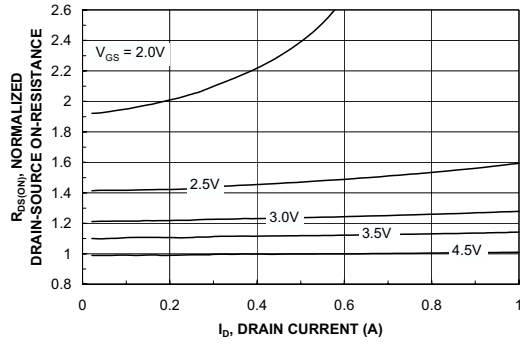

Figure 2. On-Resistance Variation with Drain Current and Gate Voltage.

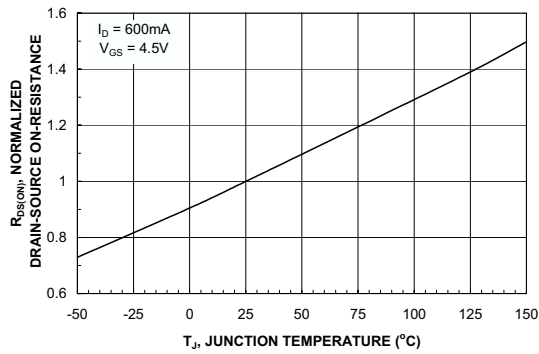

Figure 3. On-Resistance Variation with Temperature.

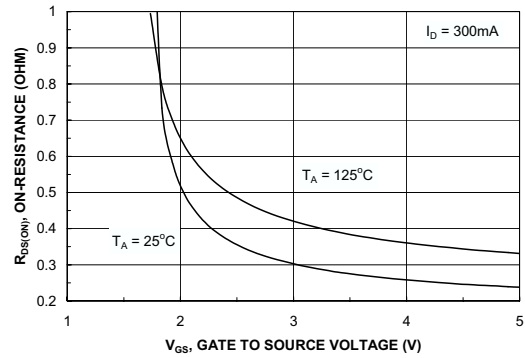

Figure 4. On-Resistance Variation with Gate-to-Source Voltage.

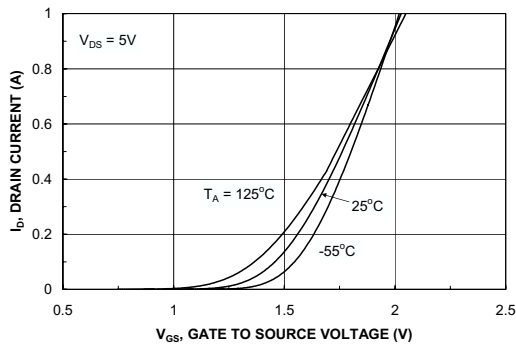

Figure 5. Transfer Characteristics.

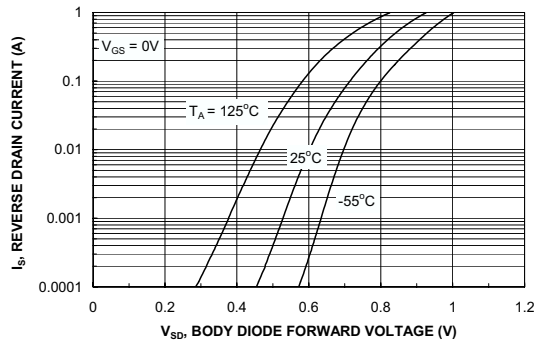

Figure 6. Body Diode Forward Voltage Variation with Source Current and Temperature.

Typical Characteristics

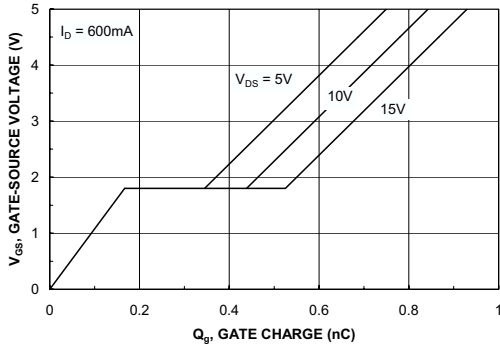

Figure 7. Gate Charge Characteristics.

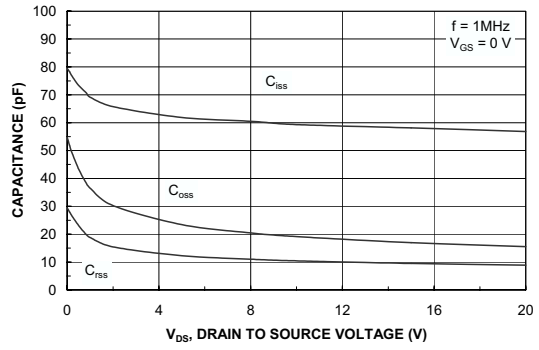

Figure 8. Capacitance Characteristics.

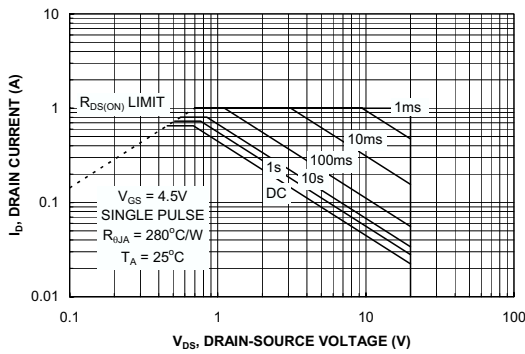

Figure 9. Maximum Safe Operating Area.

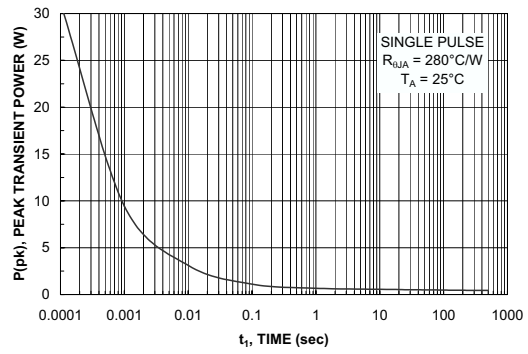

Figure 10. Single Pulse Maximum Power Dissipation.

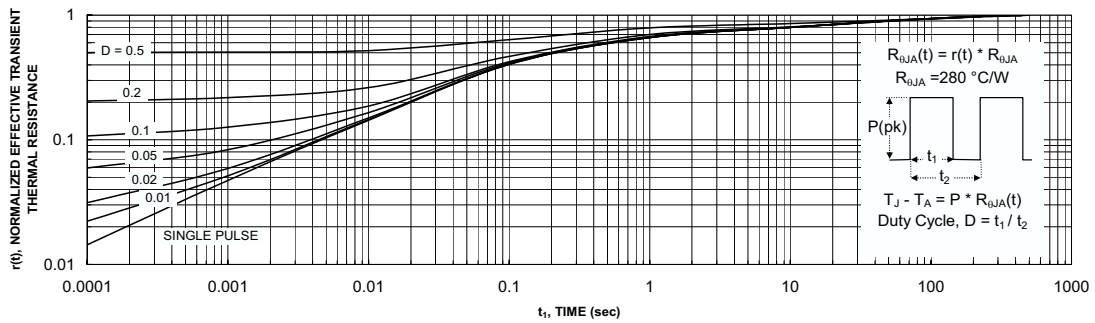
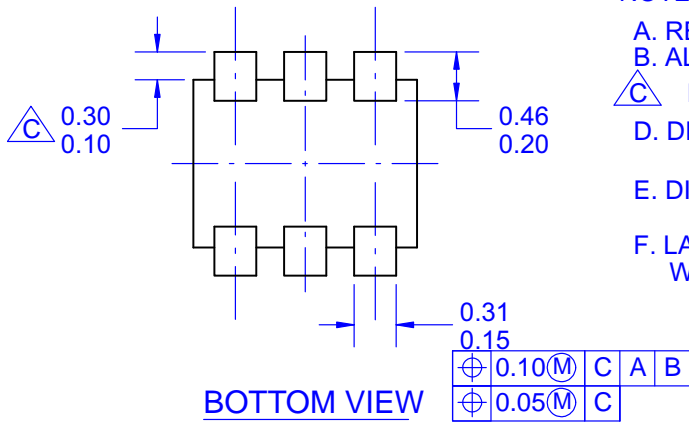
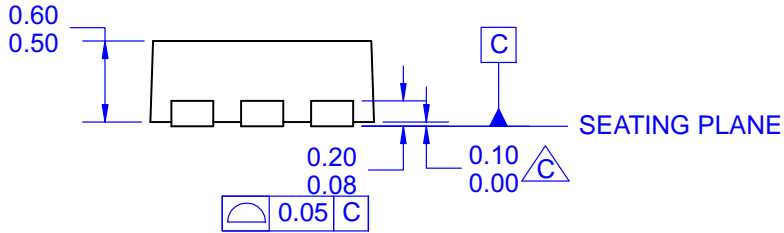
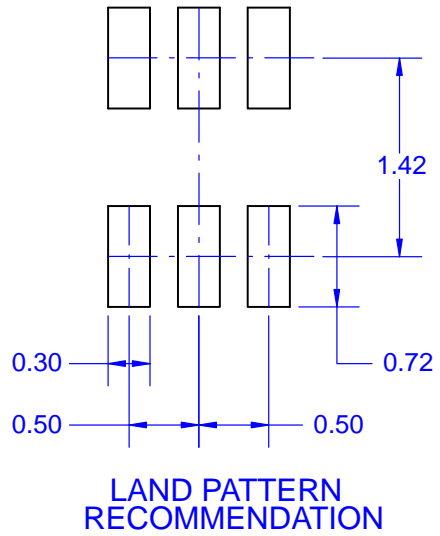
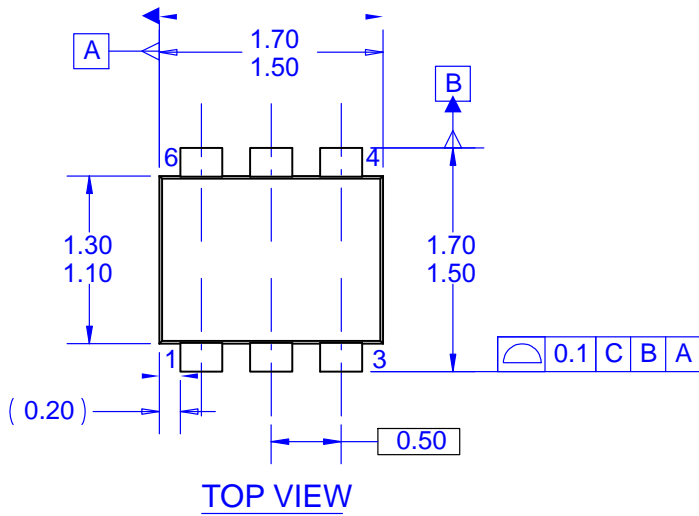

Figure 11. Transient Thermal Response Curve.

Thermal characterization performed using the conditions described in Note 1b. Transient thermal response will change depending on the circuit board design.

SOT-563
CASE 419BH
ISSUE O



NOTES: UNLESS OTHERWISE SPECIFIED.

A. REFERENCE TO JEDEC MO293.

B. ALL DIMENSIONS ARE IN MILLIMETERS.

$\triangle C$ DOES NOT COMPLY JEDEC STANDARD VALUE

D. DIMENSIONS ARE EXCLUSIVE OF BURRS, MOLD FLASH AND TIE BAR PROTRUSION.

E. DIMENSION AND TOLERANCE AS PER ASME Y14.5-2009.

F. LANDPATTERN RECOMMENDATION GENERATED WITH IPC LANDPATTERN GENERATOR

ON Semiconductor and  are trademarks of Semiconductor Components Industries, LLC dba ON Semiconductor or its subsidiaries in the United States and/or other countries. ON Semiconductor owns the rights to a number of patents, trademarks, copyrights, trade secrets, and other intellectual property. A listing of ON Semiconductor's product/patent coverage may be accessed at www.onsemi.com/site/pdf/Patent-Marking.pdf. ON Semiconductor reserves the right to make changes without further notice to any products herein. ON Semiconductor makes no warranty, representation or guarantee regarding the suitability of its products for any particular purpose, nor does ON Semiconductor assume any liability arising out of the application or use of any product or circuit, and specifically disclaims any and all liability, including without limitation special, consequential or incidental damages. Buyer is responsible for its products and applications using ON Semiconductor products, including compliance with all laws, regulations and safety requirements or standards, regardless of any support or applications information provided by ON Semiconductor. "Typical" parameters which may be provided in ON Semiconductor data sheets and/or specifications can and do vary in different applications and actual performance may vary over time. All operating parameters, including "Typicals" must be validated for each customer application by customer's technical experts. ON Semiconductor does not convey any license under its patent rights nor the rights of others. ON Semiconductor products are not designed, intended, or authorized for use as a critical component in life support systems or any FDA Class 3 medical devices or medical devices with a same or similar classification in a foreign jurisdiction or any devices intended for implantation in the human body. Should Buyer purchase or use ON Semiconductor products for any such unintended or unauthorized application, Buyer shall indemnify and hold ON Semiconductor and its officers, employees, subsidiaries, affiliates, and distributors harmless against all claims, costs, damages, and expenses, and reasonable attorney fees arising out of, directly or indirectly, any claim of personal injury or death associated with such unintended or unauthorized use, even if such claim alleges that ON Semiconductor was negligent regarding the design or manufacture of the part. ON Semiconductor is an Equal Opportunity/Affirmative Action Employer. This literature is subject to all applicable copyright laws and is not for resale in any manner.

PUBLICATION ORDERING INFORMATION

LITERATURE FULFILLMENT:

Literature Distribution Center for ON Semiconductor
19521 E. 32nd Pkwy, Aurora, Colorado 80011 USA
Phone: 303-675-2175 or 800-344-3860 Toll Free USA/Canada
Fax: 303-675-2176 or 800-344-3867 Toll Free USA/Canada
Email: orderlit@onsemi.com

N. American Technical Support: 800-282-9855 Toll Free
USA/Canada
Europe, Middle East and Africa Technical Support:
Phone: 421 33 790 2910
Japan Customer Focus Center
Phone: 81-3-5817-1050

ON Semiconductor Website: www.onsemi.com
Order Literature: <http://www.onsemi.com/orderlit>
For additional information, please contact your local
Sales Representative