

16 W single end cap T8 lighting demo board

Using IPN60R3K4CE (CoolMOS™ CE in SOT-223 package)

About this document

Scope and purpose

This document is for a 16 W/270 mA single stage single end cap T8 LED lamp reference using average current control and a cascaded structure for a floating bulk topology design using the Infineon LED driver ICL8201 and CoolMOS™ [IPN60R3K4CE](#) (SOT-223). It has high efficiency, high PFC and various protection features with a very low external component count. The [ICL8201](#) also supports a simple buck inductor without an auxiliary winding.

Intended audience

This document is intended for users of the ICL8201 who wish to design very low cost, high efficiency, high power factor LED drivers in a single end cap T8 form factor for LED lamps. It also showcases the use of CoolMOS™ CE in a SOT-223 package.

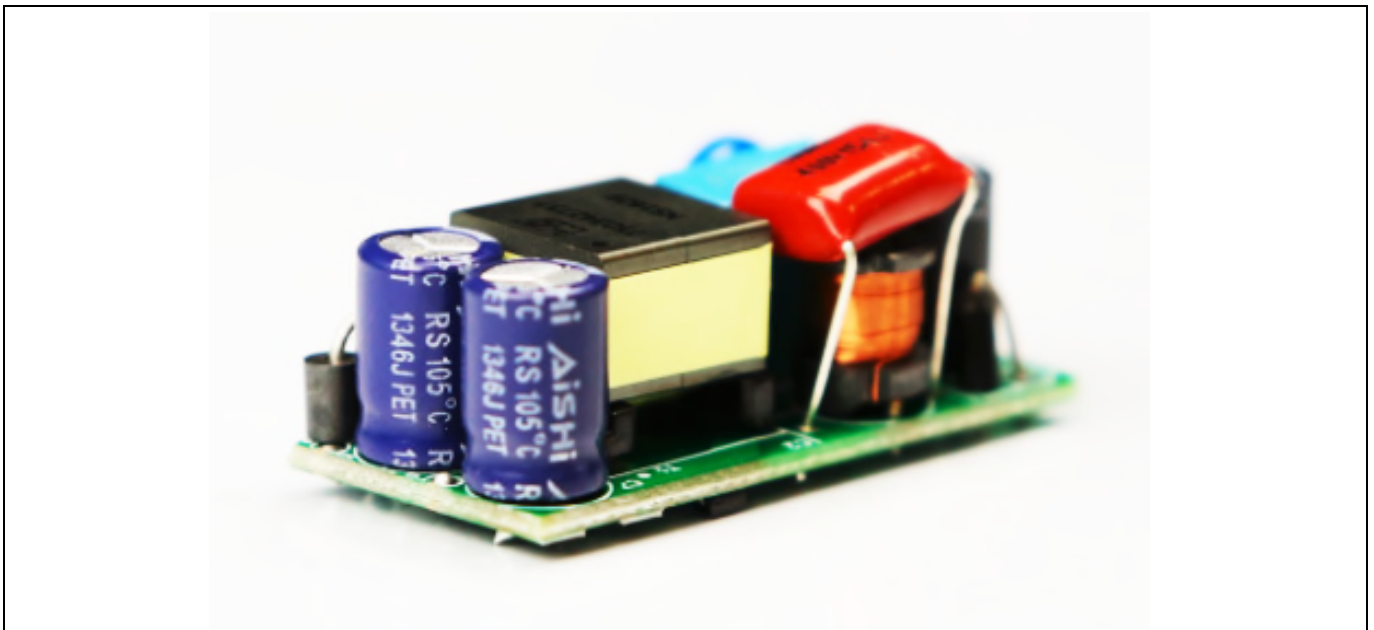

Figure 1 ICL8201 demo board

Table of Contents

About this document	1
Table of Contents	2
1 Board introduction	3
2 Board specifications.....	4
3 Build information	5
3.1 Schematic.....	5
3.2 Board layout	5
3.3 Bill of materials.....	6
3.4 Inductor specification	7
4 Test results.....	8
4.1 Connections and initial power-up	8
4.2 Startup.....	8
4.3 Switching waveform.....	9
4.4 Output waveform	9
4.5 Input waveform	10
5 Protections.....	11
5.1 Output short protection.....	11
5.2 Open output protection	12
5.3 Short winding protection.....	13
6 Test results.....	14
7 Thermal performance	15
8 Conclusion	16
9 References	17
Revision History	18

Board introduction

1 Board introduction

This application note is an engineering report for a single end cap T8 LED lamp reference design for high line input 16 W/61 V converters. The converter uses the ICL8201, average current controlled, non-isolated single stage buck topology in a cascade structure LED driver and the IPN60R3K4CE (SOT-223); a CE series of high voltage power CoolMOS™. The distinguishing features of this reference design include high efficiency and high power factor with a single stage design, critical conduction mode operation with a single choke (without an auxiliary winding), regulated output current over a wide output voltage range, good EMI performance, and various modes of protection for high reliability with a small form factor that can easily fit into the single end cap of a standard T8 LED lamp.

This document contains the list of features, the power supply specification, schematic, bill of materials, and the transformer construction documentation. Typical operating characteristics such as performance curves and oscilloscope waveforms are shown at the end of the report.

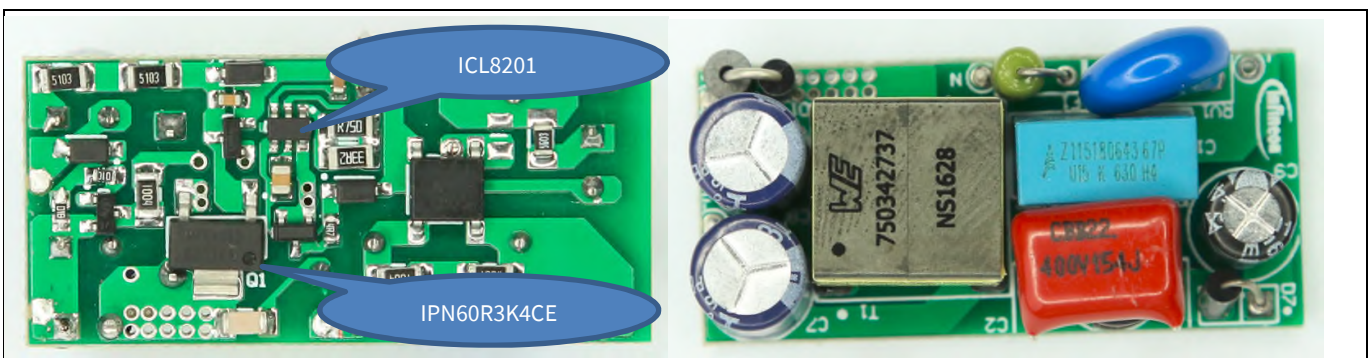

Figure 2 16 W/61 V, single end cap T8 LED lamp demo board based on IPN60R3K4CE CoolMOS™ CE

The operation of the ICL8201 controller and its feature set are explained in detail in the application note – [18 W 270 mA single stage floating buck LED \(single end cap T8\) converter with ICL8201 and IPS65R1K5CE](#) available on the Infineon website at:

http://www.infineon.com/dgdl/Infineon-ICL8201_T8+Tube+Reference+Design-RD-v01_00-EN.pdf?fileId=5546d4624d6fc3d5014dd2e6b4ab7958

The benefits of a SOT-223 CoolMOS™ CE device are explained in detail at

<http://www.infineon.com/cms/en/product/power/power-mosfet/latest-packages/sot-223/channel.html?channel=5546d462525dbac40153141e97d0618f>

The application note

http://www.infineon.com/dgdl/Infineon-ApplicationNote_High_Voltage+CoolMOS_in_SOT-223-AN-v01_00-EN.pdf?fileId=5546d46253e9fadc0153f07db9d44209

Board specifications

2 Board specifications

The inputs for the 16 W ICL8201_T8 board are Line (L) and Neutral (N); the operating AC input voltage range is 170 V_{ac} to 277 V_{ac}. The outputs of the 16 W ICL8201_T8 are V+ and V-, which can supply 61 V at 270 mA to the LED module.

The efficiency of the module is >90% while the power factor is over 0.95.

The default setting (used for all measurements in this document) is 61 V at 270 mA at the output for the SOT-223 evaluation.

Attention: This is a non-isolated design and high voltage exists at the output! Using an isolation transformer is advised while evaluating this demo board

Table 1 Design specifications

Parameter	Specification
Input voltage	170 V _{ac} to 277 V _{ac}
Input frequency	50 Hz
Output voltage	55 V to 75 V, 61 V default
Output current	270 mA
Output power	16.5 W default, 18 W maximum
Power factor	>0.95
THD	<20 %
Efficiency	>90 %

Build information

3 Build information

3.1 Schematic

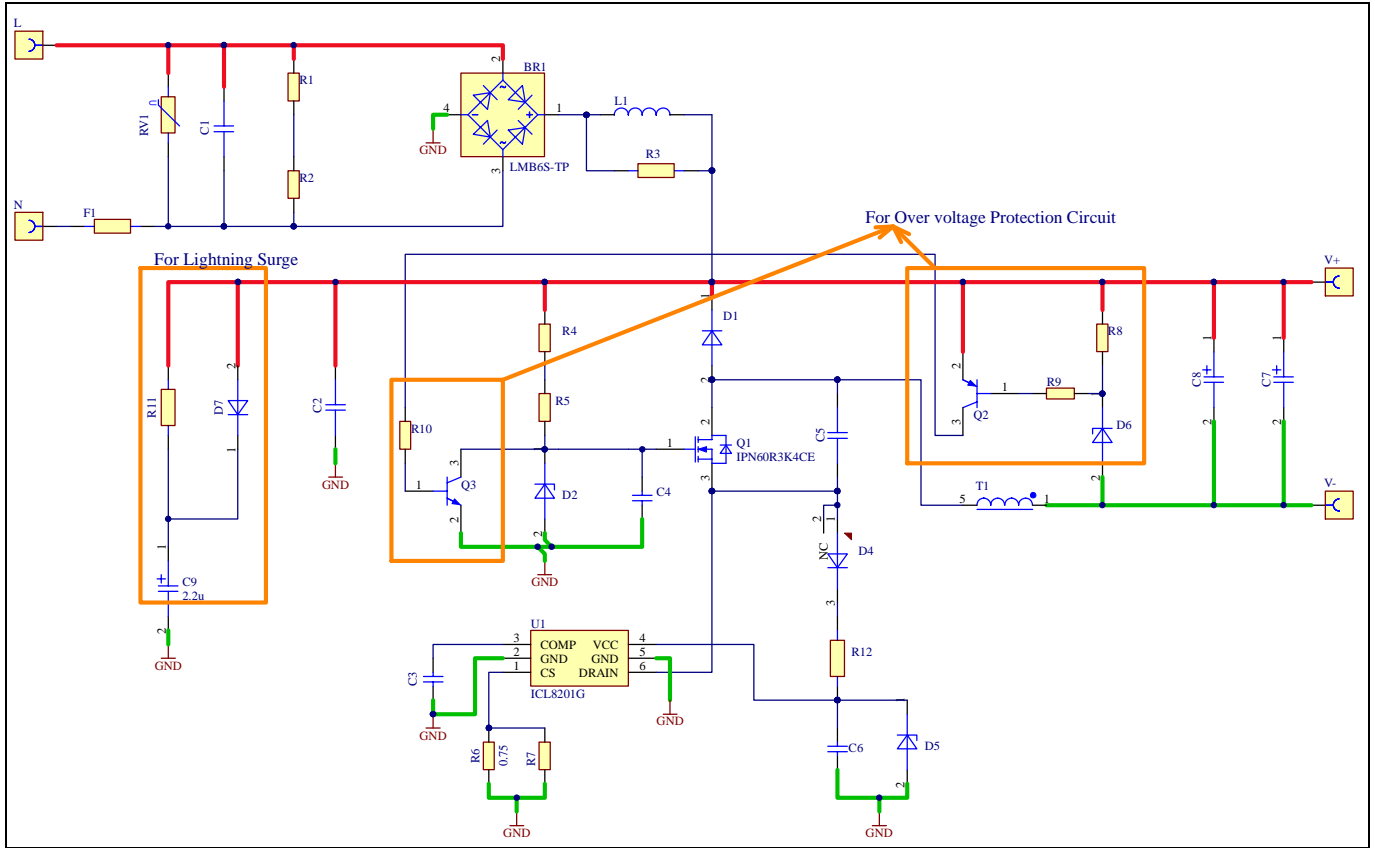

Figure 3 Board schematic

3.2 Board layout

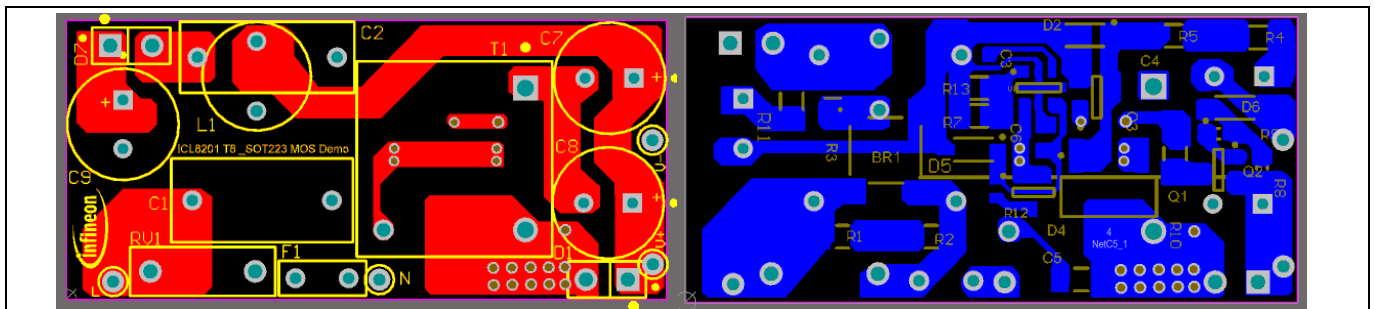

Figure 4 Board layout top view (left) and bottom view (right)

Build information

3.3 Bill of materials

Table 2 Bill of materials

No.	Designator	Manufacturer	Part Number	Description	Qty
1	F1	Littelfuse	0263003.MXL	FUSE, PCB, 3 A, 250 V, VERY FAST ACTING	1
2	RV1	EPCOS	B72210S0301K101	VARISTOR 423 V 2.5 kA DISC 10MM	1
3	BR1	Micro Commercial	LMB6S-TP	BRIDGE RECTIFIER 1 A 600 V LMBS-1	1
4	L1	Bourns	RL875-222K-RC	INDUCTOR, 2.2 mH, ±10%, 180 mA, DCR=6.25 Ω	1
5	D1	ON Semi	MUR260G	DIODE, RECTIFIER, 2 A, 600 V, DO-15	1
6	D2,D5	ON Semi	MMSZ5245BT1G	DIODE ZENER 12 V 500 mW SOD123	2
7	D4	Infineon	BAS 16 E6327	DIODE SWITCH 80 V 0.25 A SOT23	1
8	D6	ON Semi	MMSZ5268BT1G	DIODE, ZENER, 82 V, 500 mW, SOD-123	1
9	D7	MULTICOMP	1N4007G	DIODE, STANDARD, 1 A, 1000 V, DO41	1
10	C1	Kemet	F861AP154M310L	CAP FILM 0.15 uF 630 VDC RADIAL (P=10mm)	1
11	C2	Faratronic	C222G154K40	CAP FILM 0.15 uF 400 VDC 10% RADIAL	1
12	C3	Murata	GRM188R71A225KE15D	CAP CER 2.2 uF 10 V 10% X7R 0603	1
13	C4	Yageo	CC0603KRX7R8BB103	CAP CER 10 nF 25 V 10% X7R 0603	1
14	C5	Yageo	CC1206JRNPOBBN220	CAP CER 22 pF 500 V 5% NP0 1206	1
15	C6	Murata	GRM21BR71E225KA73L	CAP CER 2.2 uF 25 V 10% X7R 0805	1
16	C7, C8	RUBYCON	100ZLJ33M8X11.5	CAP ALU 100 V, 47 uF, ±20%, 10,000hrs @ 105	2
17	C9	Rubycon	400PX2R2MEFC8X11.5	CAP, ALU ELEC, 2.2 uF, 400 V, RAD	1
18	R1, R2, R10	Yageo	RC1206FR-071ML	RES 1.00 MOHM 1/4 W 1% 1206 SMD	3
19	R4, R5	KOA Spear	RK73H2BTDD5103F	RES 510 kOHM 1/4 W 1% 1206 SMD	2
20	R6	Vishay	RCWE1206R750FKEA	RES 0.75 R OHM 1/2 W 1% 1206	1

16 W Single End Cap T8 lighting demo board
Using IPN60R3K4CE (CoolMOST™ CE in SOT-223 package)



Build information

				SMD	
21	R8	Yageo	RC0603FR-071KL	RES 1 kOHM 1/10W 1% 0603 SMD	1
22	R9	Yageo	RC0603FR-0710KL	RES 10 kOHM 1/10W 1% 0603 SMD	1
23	R11	Yageo	RC0805JR-07560KL	RES 560 kOHM 1/8W 5% 0805 SMD	1
24	R12	Yageo	RC0603JR-074R7L	RES 4.7 R OHM 1/10W 5% 0603 SMD	1
25	T1	Würth	750342737	EP13, 850 uH, ±10%	1
26	Q1	Infineon	IPN60R3K4CE	MOSFET, 600 V, 3K4Ω, SOT-223	1
27	Q2	NXP	PBHV9050T	TRANSISTOR PNP 500 V 150 mA SOT23	1
28	Q3	Infineon	SMBT3904	TRANSISTOR NPN 40 V 150 mA SOT23	1
29	U1	Infineon	ICL8201	LED buck controller	1
30	Ferrite Bead	KEMET	B-20F-38	FERRITE CORE, CYLINDRICAL, 1.5mm X 4.3mm	1
31	PCB			FR4, 2 Layer, 1oz, Soldermask, 42x20x15 mm	1

3.4 Inductor specification

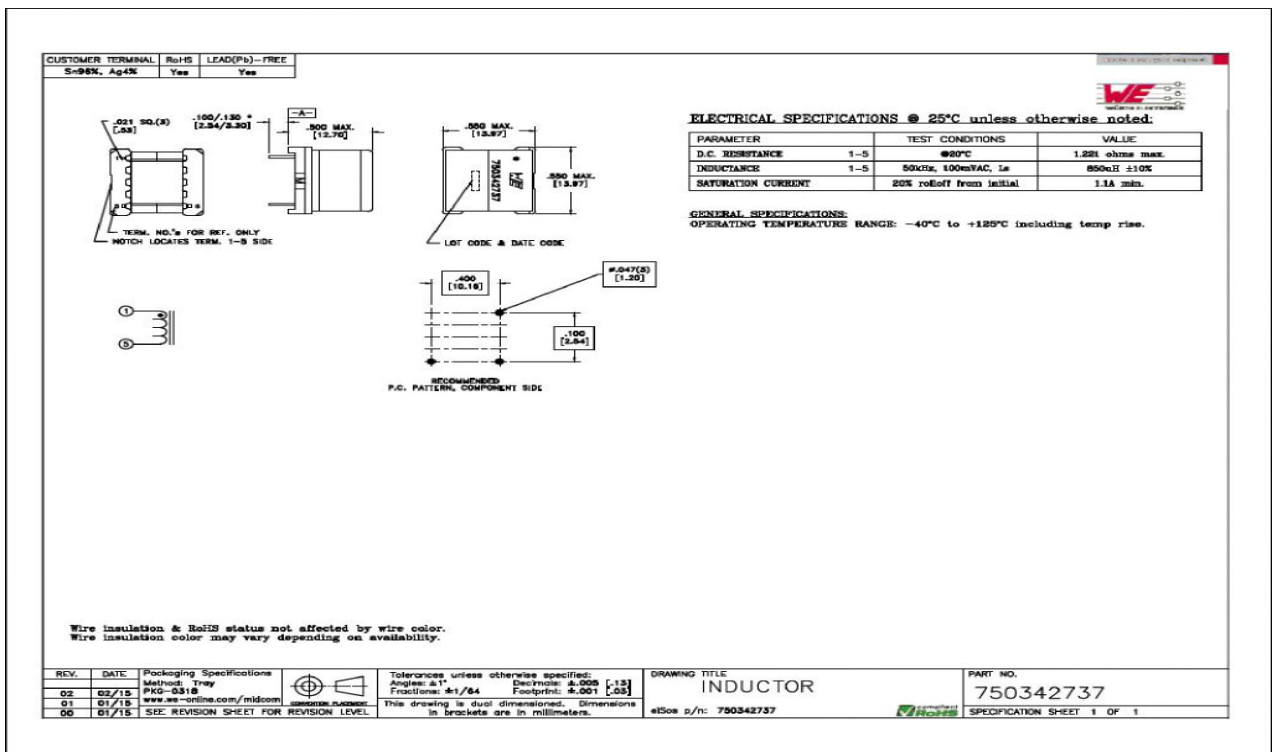

Figure 5 Inductor specification

Test results

4 Test results

4.1 Connections and initial power-up

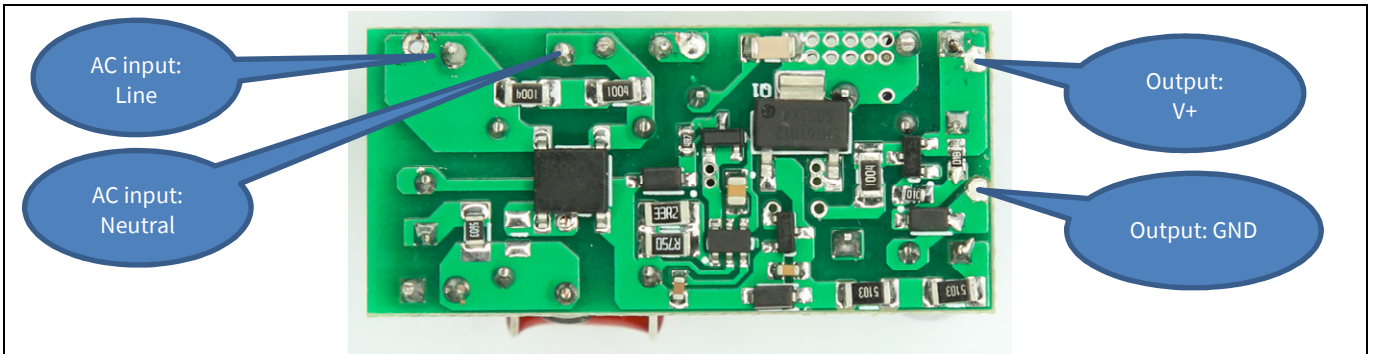

Figure 6 PCB bottom showing where to connect AC input and load.

Connect the AC input to the board as shown above. The output voltage (V+) and ground (GND) should be connected to an external load at the terminals. In order to load with an external resistor for testing, use a 220 Ω resistor to obtain 18 W or 275 mA at 60 V.

4.2 Startup

When the AC input voltage is applied to the reference board, the V_{cc} capacitor will be charged through external LED module, buck choke (T1), external power switch (Q1) and V_{cc} diode. Once the V_{cc} voltage reaches 7.5 V, the IC will start switching with a digital soft start and enter into normal operation.

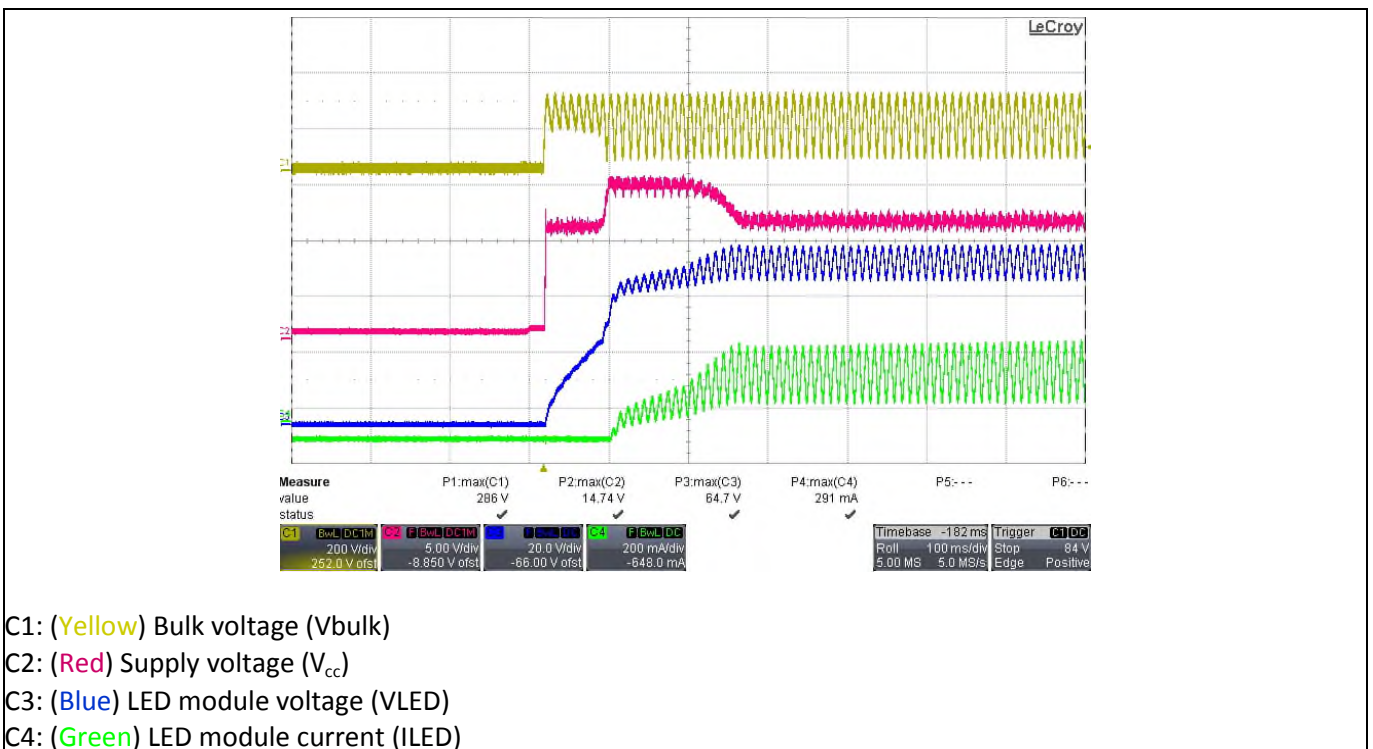

Figure 7 Startup waveform

16 W Single End Cap T8 lighting demo board Using IPN60R3K4CE (CoolMOST™ CE in SOT-223 package)

Test results

4.3 Switching waveform

The current mode controller (ICL8201) has zero current switching without a zero crossing detection winding, by sensing the drain pin voltage of the controller. This helps to simplify the structure of the buck choke by not requiring an auxiliary winding and improving both EMI performance and efficiency. A typical switching waveform of the ICL8201 is shown below.

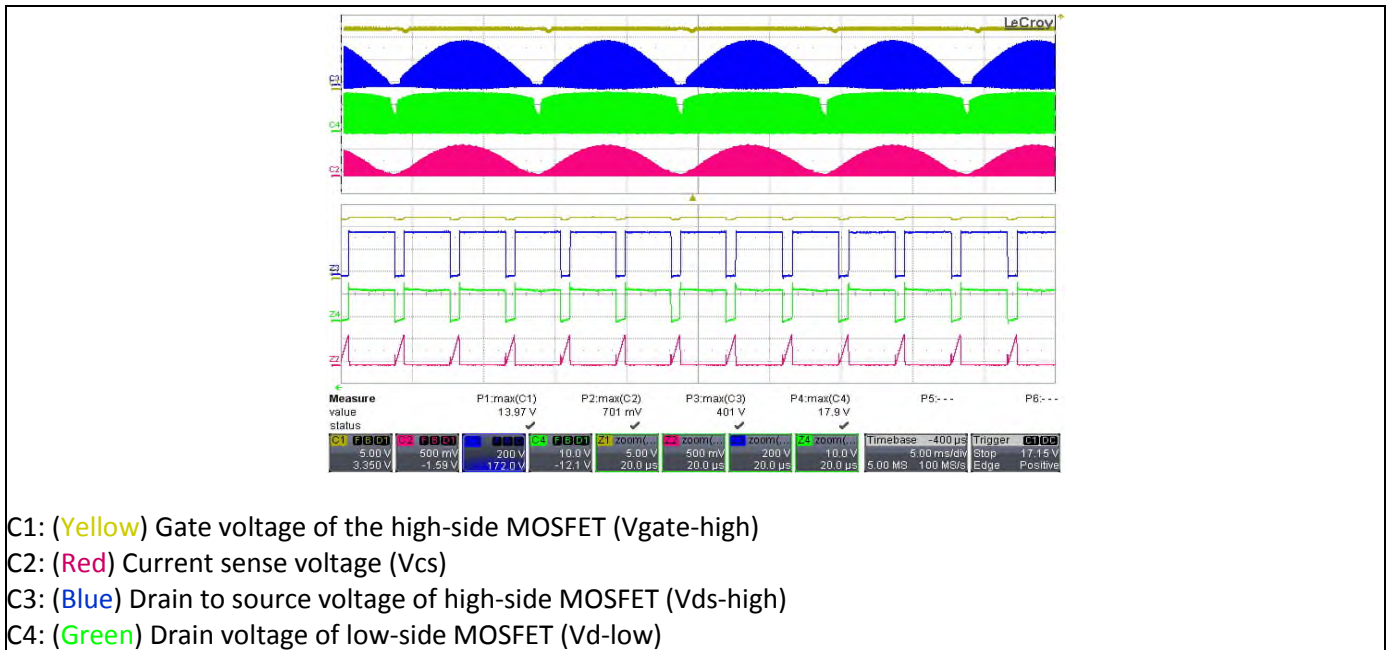

- C1: (Yellow) Gate voltage of the high-side MOSFET (Vgate-high)
- C2: (Red) Current sense voltage (Vcs)
- C3: (Blue) Drain to source voltage of high-side MOSFET (Vds-high)
- C4: (Green) Drain voltage of low-side MOSFET (Vd-low)

Figure 8 Switching waveform @277 V_{ac}

4.4 Output waveform

The output capacitor is sized for an output current ripple that exhibits no visible light modulation. The following figure shows the measured waveform of output voltage and current during normal operation at 230 V_{ac} and full load.

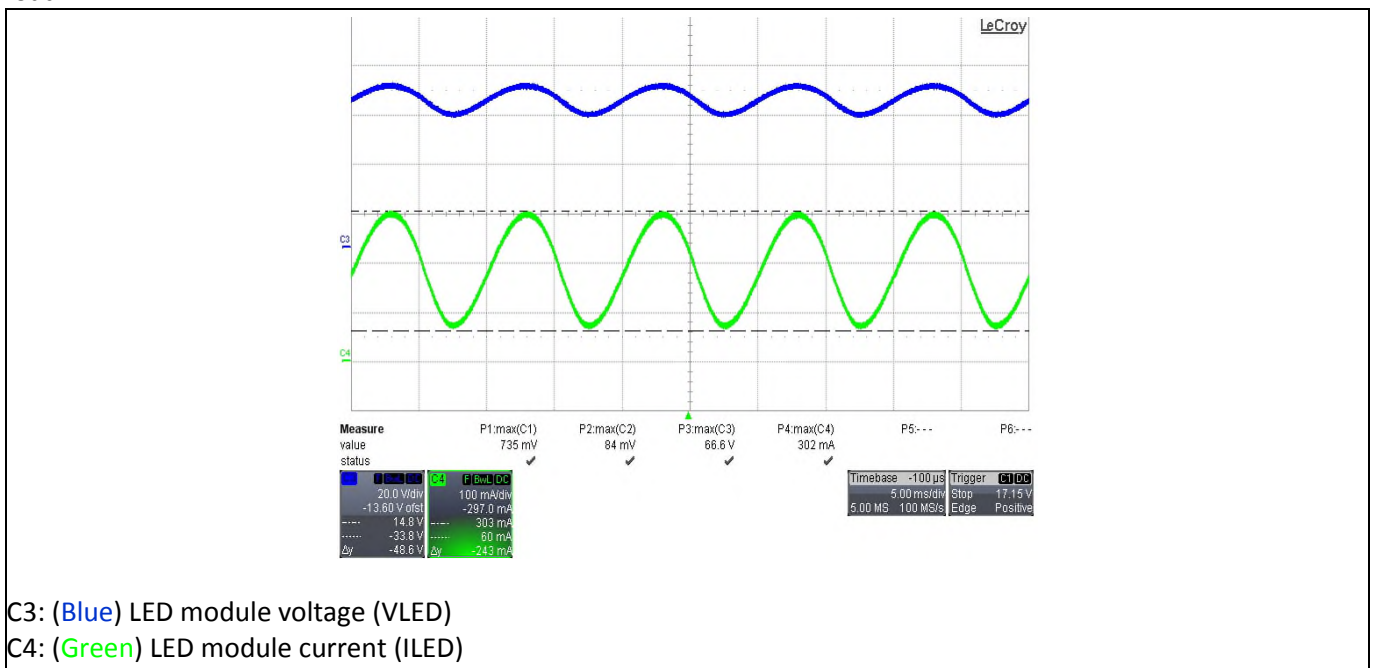

- C3: (Blue) LED module voltage (VLED)
- C4: (Green) LED module current (ILED)

Figure 9 Startup waveform

16 W Single End Cap T8 lighting demo board Using IPN60R3K4CE (CoolMOS™ CE in SOT-223 package)

Test results

4.5 Input waveform

The figure below shows the waveforms for input voltage, current and the current sense pin voltage during normal operation at 230 V_{ac} and full load.

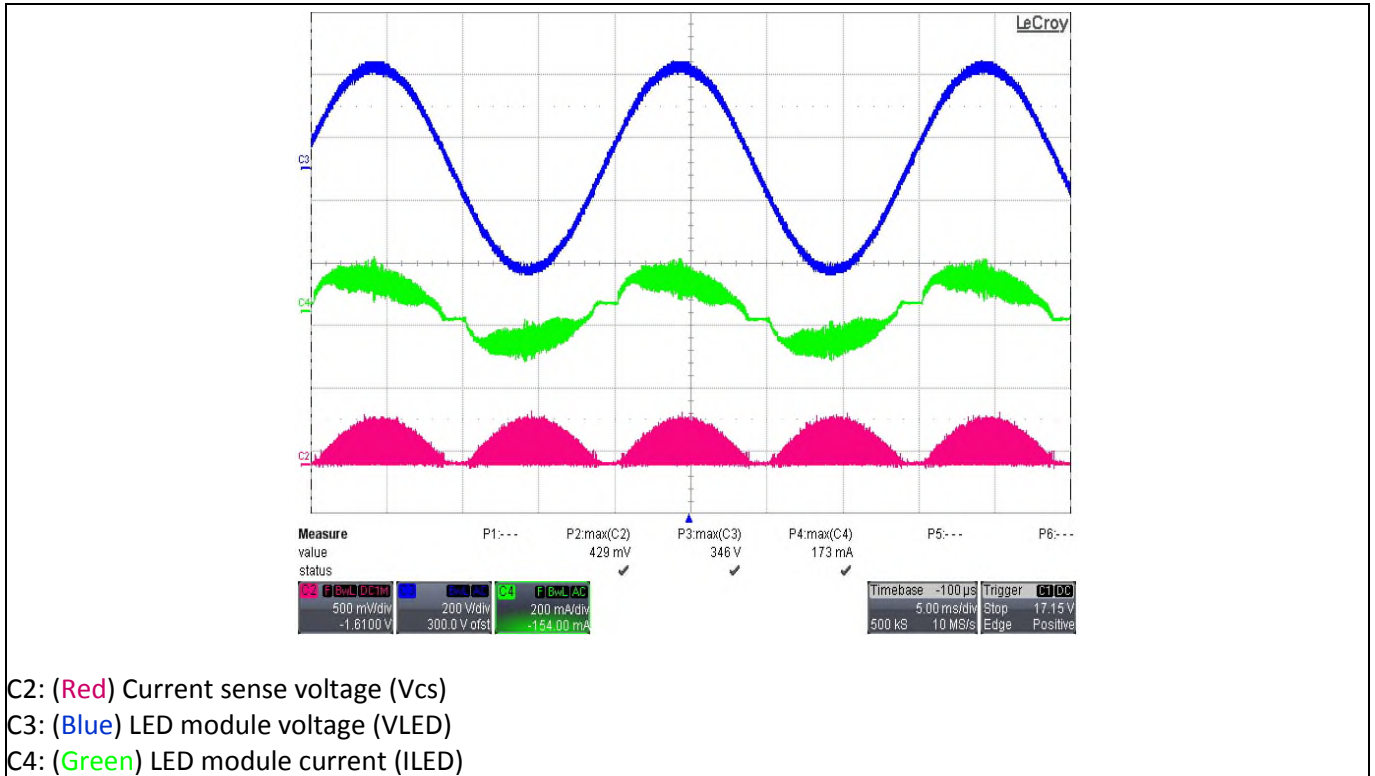

Figure 10 Input voltage and current @ 230 V_{ac}

Protections

5 Protections

5.1 Output short protection

The tested waveform in startup mode and run Mode is shown below. The system board enters into latch mode, and the power consumption is 0.22 W @ $V_{in} = 230 V_{ac}/50 Hz$.

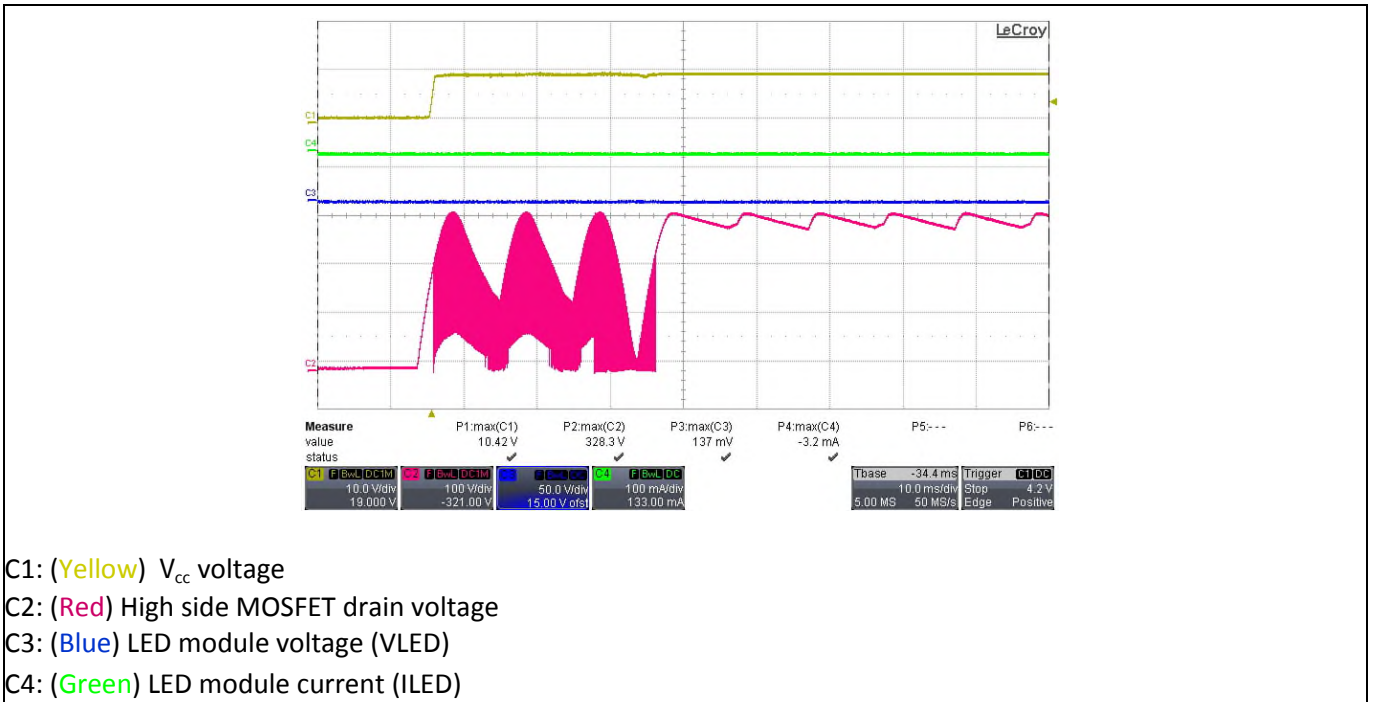

Figure 11 Waveform during start-up mode (61 V, 270 mA LED load @ $V_{in} = 230 V_{ac}/50 Hz$)

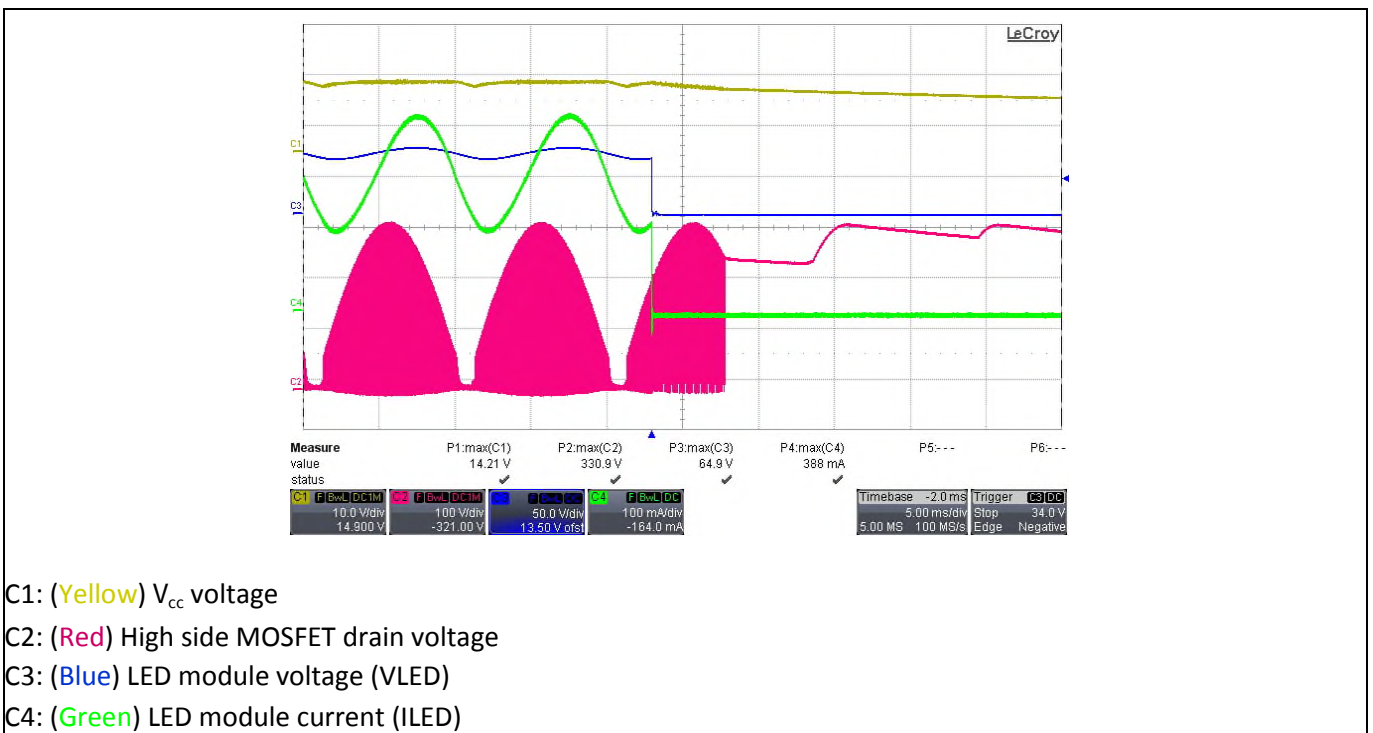

Figure 12 Waveform during run mode (61 V, 270 mA LED load @ $V_{in} = 230 V_{ac}/50 Hz$)

16 W Single End Cap T8 lighting demo board Using IPN60R3K4CE (CoolMOST™ CE in SOT-223 package)

Protections

5.2 Open output protection

Adding an external OVP circuit allows this reference design to achieve output open circuit protection. The tested waveform during start-up mode and run mode is shown below. When the system enters into auto restart mode, the power consumption is 0.3 W and Vled is clamped to 82 V @ $V_{in} = 230 V_{ac}/50 Hz$.

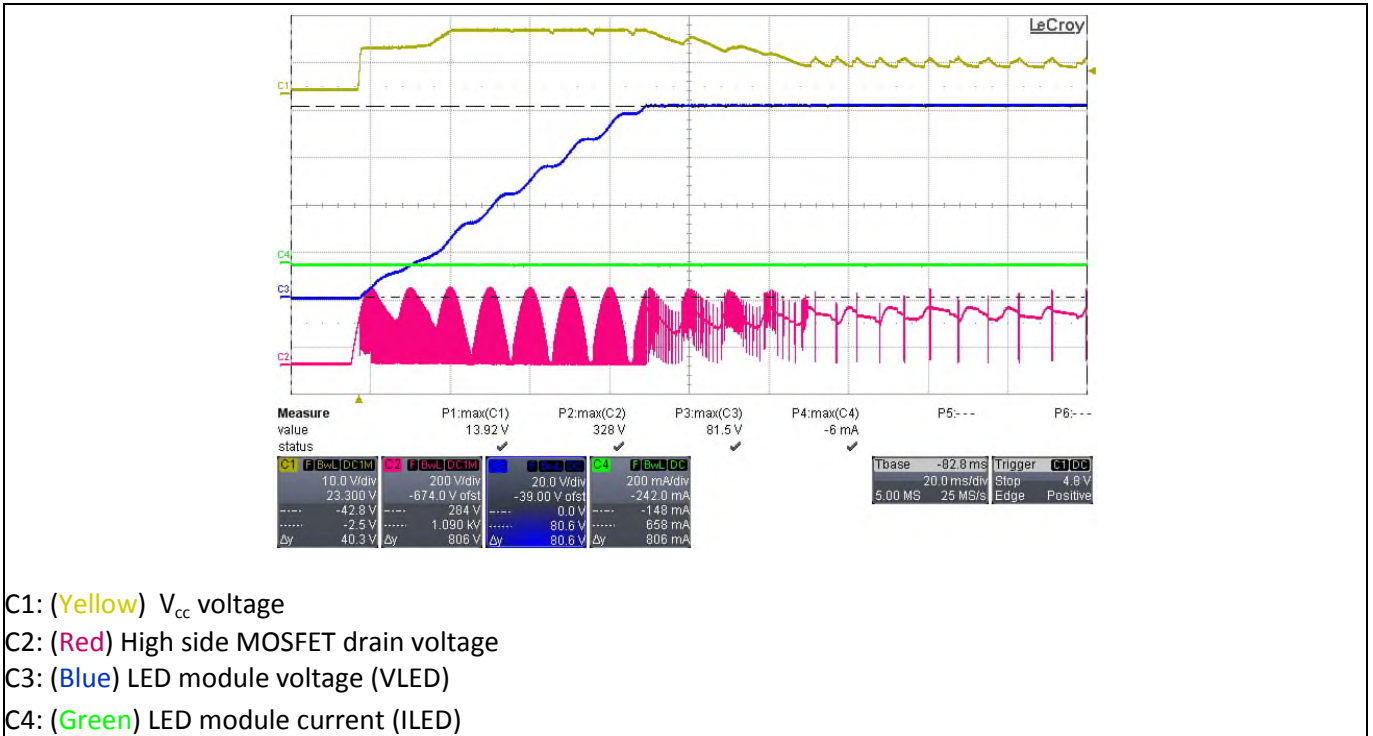

Figure 13 Waveform of start-up mode (61 V, 270 mA LED load @ $V_{in} = 230 V_{ac}/50 Hz$)

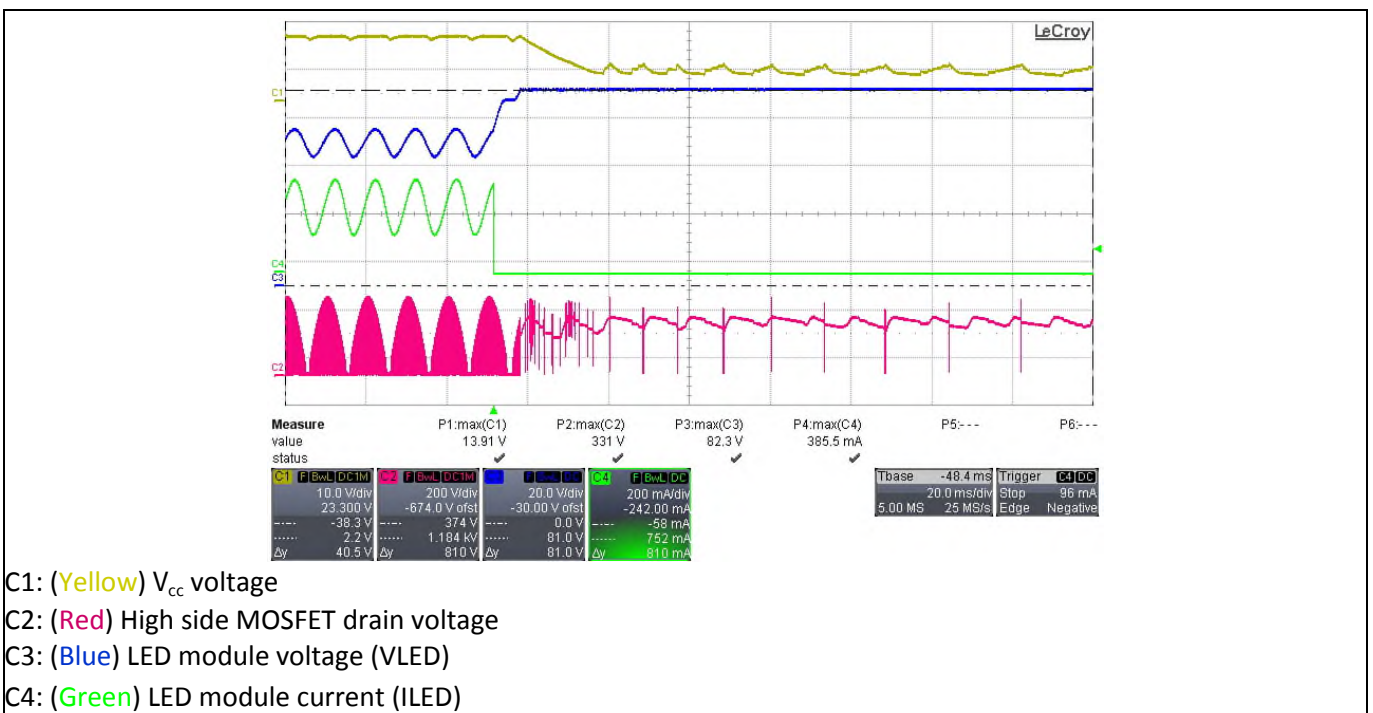
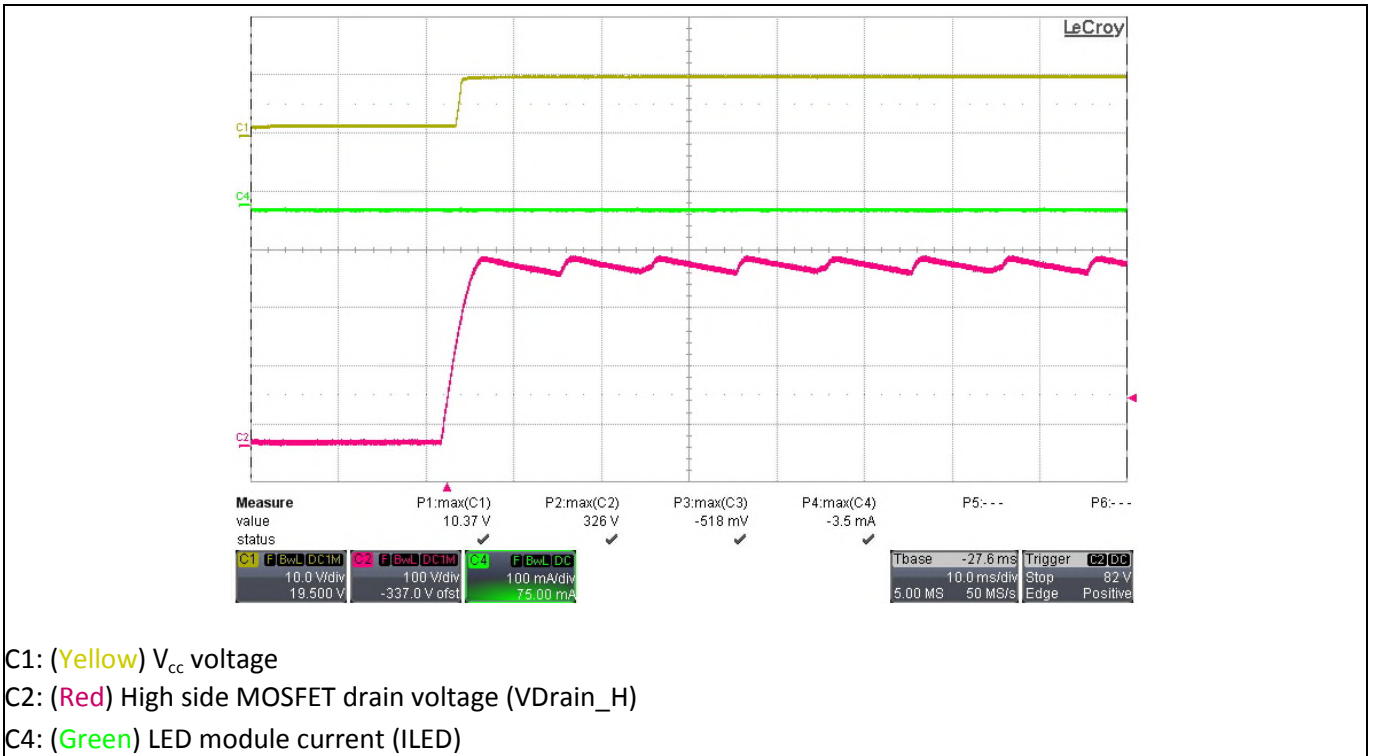

Figure 14 Waveform of run mode (61 V, 270 mA LED load @ $V_{in} = 230 V_{ac}/50 Hz$)

Protections

5.3 Short winding protection

The figures below show the waveforms of V_{cc} , the LED output current, and the drain on the high side MOSFET during the short winding protection under start-up and run mode.



C1: (Yellow) V_{cc} voltage
C2: (Red) High side MOSFET drain voltage (VDrain_H)
C4: (Green) LED module current (ILED)

Figure 15 Waveform of start-up mode (61 V, 270 mA LED load @ $V_{in} = 230 V_{ac}/50$ Hz)

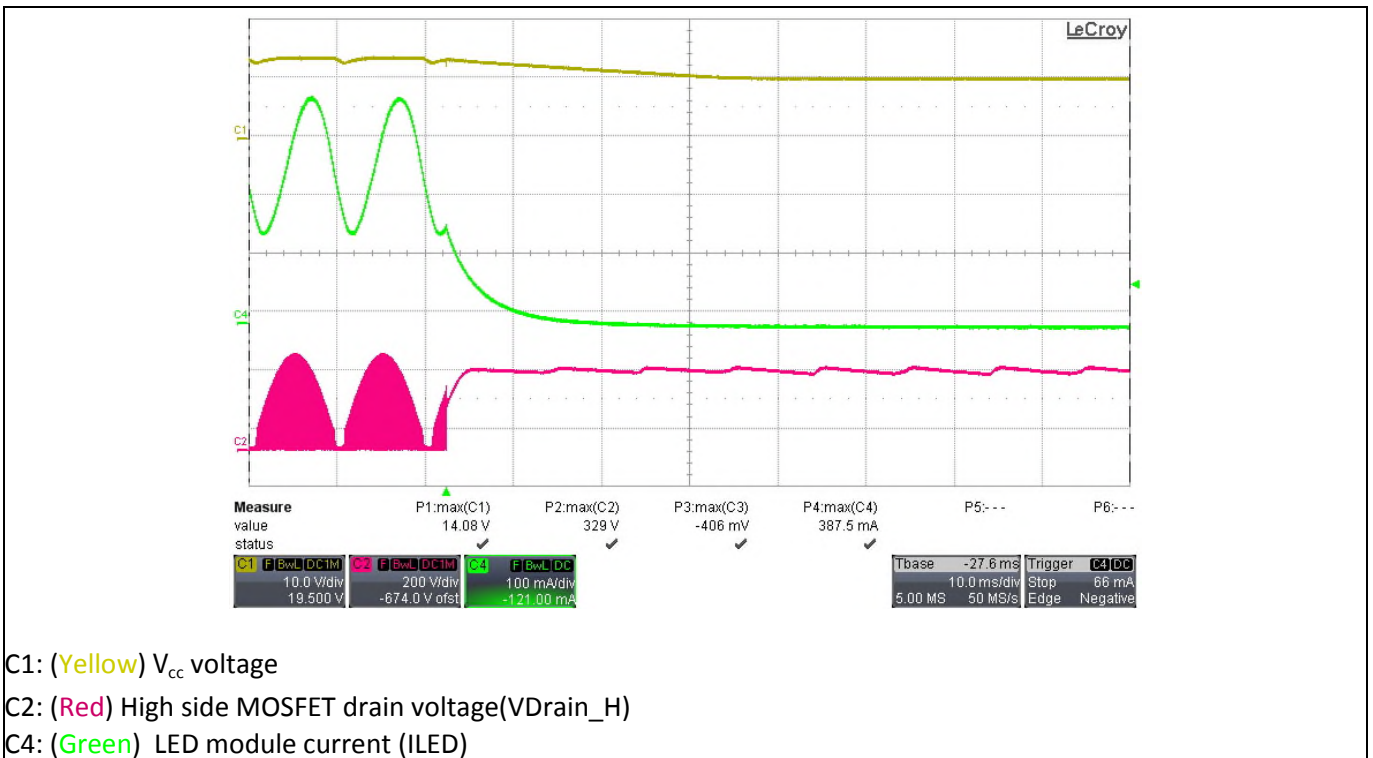

C1: (Yellow) V_{cc} voltage
C2: (Red) High side MOSFET drain voltage (VDrain_H)
C4: (Green) LED module current (ILED)

Figure 16 Waveform of run mode (61 V, 270 mA LED load @ $V_{in} = 230 V_{ac}/50$ Hz)

Test results

6 Test results

Table 3 Efficiency results at 61 V and 270 mA of LED load

V _{in} @50 Hz (V _{ac})	P _{in} (W)	PF	THD	V _{out} (V _{DC})	I _{out} (mA)	P _{out} (W)	ΔI _{out} (%)	Efficiency (%)	Average Efficiency (%)
170	18.04	0.99	12.4	60.4	273	16.49	+1.11	91.40	90.94%
200	18.12	0.98	12.3	60.4	274	16.55	+1.48	91.34	
230	18.19	0.97	13.1	60.4	274	16.55	+1.48	90.98	
265	18.33	0.95	14.4	60.4	275	16.61	+1.85	90.61	
277	18.38	0.95	14.8	60.4	275	16.61	+1.85	90.36	

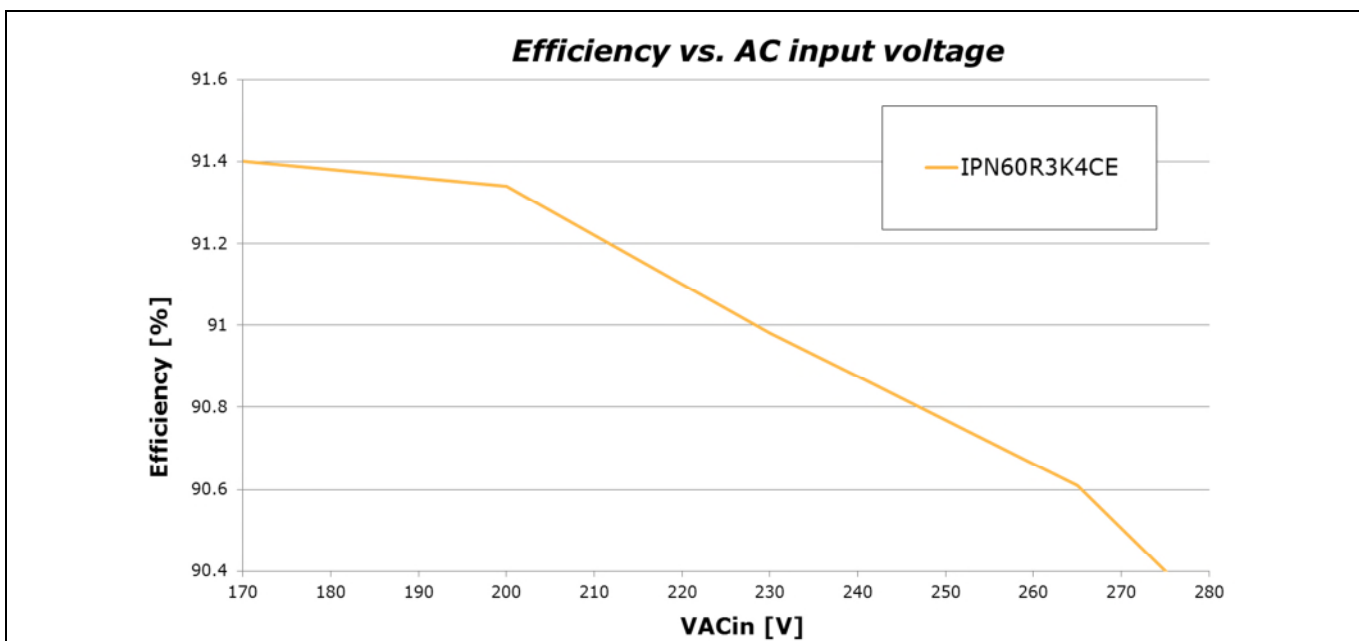

Figure 17 Demo Board Efficiency Results

Thermal performance

7 Thermal performance

The table below shows the thermal performance of the IC and power MOSFET after running for >30 minutes without an enclosure in a 25°C ambient temperature (two different conditions shown below).

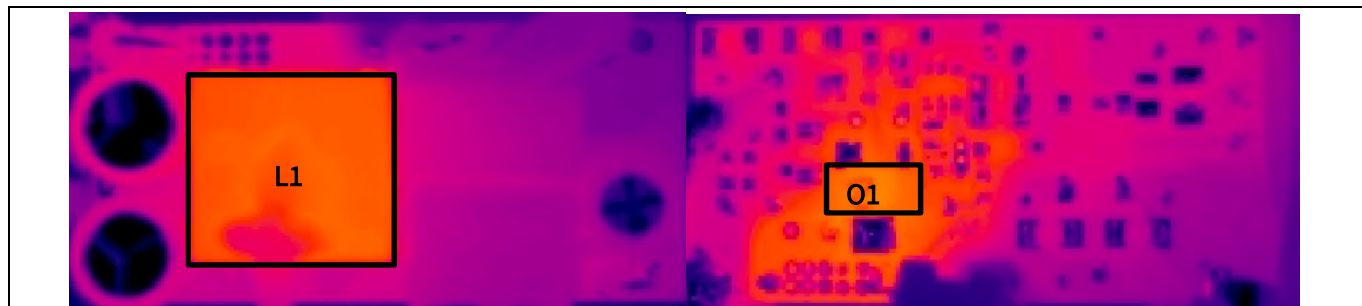

Figure 18 Thermal images of the top of the board (left) and bottom of the board (right).

Condition A: Input voltage = 170 V_{ac} - 277 V_{ac}, P_{out} = 16.2 W (59.6 V/272 mA)

Table 4 Thermal performance at 59.6 V output voltage

Item	170 V _{ac}	230 V _{ac}	277 V _{ac}
Q1	65.0 °C	69.2 °C	74.5 °C
U1	56.0 °C	56.4 °C	58.9 °C
BR1	51.8 °C	49.2 °C	49.9 °C
L1	47.6 °C	44.2 °C	44.3 °C
Ambient T	26.8 °C	27.8 °C	28.2 °C

Condition B: Input voltage = 170 V_{ac} - 277 V_{ac}, P_{out} = 18.3 W (67.4 V/272 mA)

Table 5 Thermal performance at 67.4 V output voltage

Item	170 V _{ac}	230 V _{ac}	277 V _{ac}
Q1	68.6 °C	72.2 °C	77.6 °C
U1	59.6 °C	61.2 °C	64.0 °C
BR1	55.6 °C	49.2 °C	55.7 °C
L1	50.8 °C	49.3 °C	50.0 °C
Ambient T	28.0 °C	27.4 °C	27.4 °C

Conclusion

8 Conclusion

The board effectively shows the performance of the IPN60R3K4CE – CoolMOS™ CE in the SOT-223 package for lighting applications. Furthermore the SOT-223 package gives the opportunity to further lower the cost of the system in comparison to the usage of DPAK package while not sacrificing pin-to-pin compatability.

PCB area savings and package height reductions give extra value, especially for lighting customers who have increased power density requirements.

An additional benefit of the Infineon SOT-223 package is the increased creepage distance between Gate and Source pins when compared to DPAK packages due to removing the middle drain pin.

These benefits for lighting applications make CoolMOS™ CE in the SOT-223 package an ideal fit for low cost low power lighting applications.

References

9 References

- [1] 18 W 270 mA single stage floating buck LED (Single End Cap T8) converter with ICL8201 & IPS65R1K5CE available on Infineon website at

http://www.infineon.com/dgdl/Infineon-ICL8201_T8+Tube+Reference+Design-RD-v01_00-EN.pdf?fileId=5546d4624d6fc3d5014dd2e6b4ab7958

- [2] The benefits of SOT-223 CoolMOS™ CE device is explained in detail at

<http://www.infineon.com/cms/en/product/power/power-mosfet/latest-packages/sot-223/channel.html?channel=5546d462525dbac40153141e97d0618f>

- [3] CoolMOS™ in SOT-223

http://www.infineon.com/dgdl/Infineon_ApplicationNote_High_Voltage+CoolMOS_in_SOT-223-AN-v01_00-EN.pdf?fileId=5546d46253e9fad0153f07db9d44209



Revision History

Revision History

Major changes since the last revision

Page or Reference	Description of change

Trademarks of Infineon Technologies AG

μ HVIC™, μ IPM™, μ PFC™, AU-ConvertIR™, AURIX™, C166™, CanPAK™, CIPOS™, CIPURSE™, CoolDP™, CoolGaN™, COOLiR™, CoolMOS™, CoolSET™, CoolSiC™, DAVE™, DI-POL™, DirectFET™, DrBlade™, EasyPIM™, EconoBRIDGE™, EconoDUAL™, EconoPACK™, EconoPIM™, EiceDRIVER™, eupec™, FCOS™, GaNpowIR™, HEXFET™, HITFET™, HybridPACK™, iMOTION™, IRAM™, ISOFACE™, IsoPACK™, LEDrivr™, LITIX™, MIPAQ™, ModSTACK™, my-d™, NovalithIC™, OPTIGA™, OptiMOS™, ORIGA™, PowIRaudio™, PowIRstage™, PrimePACK™, PrimeSTACK™, PROFET™, PRO-SIL™, RASIC™, REAL3™, SmartLEWIS™, SOLID FLASH™, SPOC™, StrongIRFET™, SupIRBuck™, TEMPFET™, TRENCHSTOP™, TriCore™, UHVIC™, XHP™, XMC™

Trademarks updated November 2015

Other Trademarks

All referenced product or service names and trademarks are the property of their respective owners.

Edition 2016-10-03

Published by

Infineon Technologies AG

81726 Munich, Germany

© 2016 Infineon Technologies AG.

All Rights Reserved.

Do you have a question about this document?

Email: erratum@infineon.com

Document reference

AppNote Number

IMPORTANT NOTICE

The information contained in this application note is given as a hint for the implementation of the product only and shall in no event be regarded as a description or warranty of a certain functionality, condition or quality of the product. Before implementation of the product, the recipient of this application note must verify any function and other technical information given herein in the real application. Infineon Technologies hereby disclaims any and all warranties and liabilities of any kind (including without limitation warranties of non-infringement of intellectual property rights of any third party) with respect to any and all information given in this application note.

The data contained in this document is exclusively intended for technically trained staff. It is the responsibility of customer's technical departments to evaluate the suitability of the product for the intended application and the completeness of the product information given in this document with respect to such application.

For further information on the product, technology, delivery terms and conditions and prices please contact your nearest Infineon Technologies office (www.infineon.com).

WARNINGS

Due to technical requirements products may contain dangerous substances. For information on the types in question please contact your nearest Infineon Technologies office.

Except as otherwise explicitly approved by Infineon Technologies in a written document signed by authorized representatives of Infineon Technologies, Infineon Technologies' products may not be used in any applications where a failure of the product or any consequences of the use thereof can reasonably be expected to result in personal injury.

Mouser Electronics

Authorized Distributor

Click to View Pricing, Inventory, Delivery & Lifecycle Information:

[Infineon:](#)

[EVAL16W66VBCKCETOBO1](#)