

03 0318

Circular connectors with threaded joint M16 acc. to IEC 61076-2-106, IP40/IP67/IP68



Flange chassis plug acc. to IEC 61076-2-106, IP68, with threaded joint and solder terminals, for front mounting

03

0318

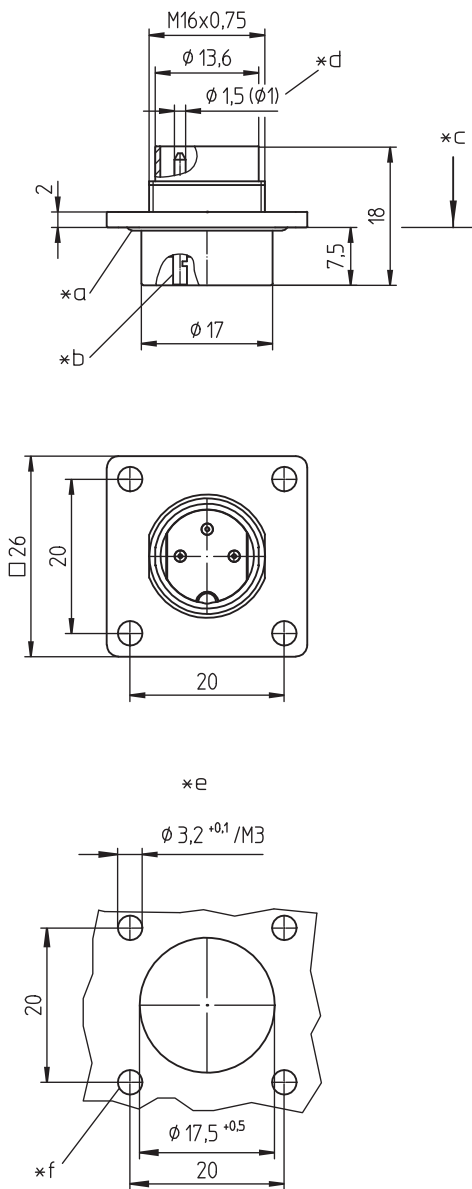

### Environmental conditions

Temperature range -40 °C/+85 °C

### Materials

Insulating body	PA GF, V-0 according to UL94
Contact pin	CuZn, silver-plated and flash gold-plated, tin-plated in solder area (3-8 poles) CuZn, pre-nickel and gold-plated, tin-plated in solder area (12-14 poles)
Housing	Zn diecast, pre-copper and nickel-plated
Seal	EPDM

### Mechanical data

Tightening torque connector	1-3 Nm
Tightening torque nut	1-3 Nm
Protection class	IP68 <sup>1</sup>

<sup>1</sup> according to IEC DIN EN 60529, only in locked condition with an appropriate counterpart; IPX8 requirements under agreement between manufacturer and user

### Connectable conductors for solder area

Section	≤ 0,75 mm <sup>2</sup> (AWG 20) (3-8 poles) ≤ 0,25 mm <sup>2</sup> (AWG 24) (12-14 poles)
---------	--

### Electrical data (at T<sub>amb</sub> 20 °C)

Rated current	5 A (T <sub>amb</sub> 40 °C, 3-8 poles) 3 A (T <sub>amb</sub> 40 °C, 12-14 poles)
Rated voltage	with pollution degree 1: 300 V (versions 03, 04, 05-1, 06, 07) 100 V (versions 05, 07-1, 08, 08-1) 160 V (versions 12, 14) with pollution degree 2: 250 V (versions 03, 04) 32 V (versions 05, 07-1, 08, 08-1) 160 V (versions 05-1, 06, 07, 12, 14)
Rated impulse voltage	1500 V (versions 03, 04, 05-1, 06, 07, 12, 14) 500 V (versions 05, 07-1, 08, 08-1)
Material group	II (IEC)/I (UL) (400 ≤ CTI < 600)
Overvoltage category	I
Insulation resistance	> 100 MΩ

03 0318

Pin configurations, solder side view

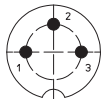

03-a  
0318 03

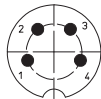

04-a  
0318 04

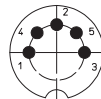

05-b  
0318 05

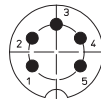

05-a  
0318 05-1

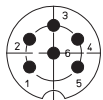

06-a  
0318 06

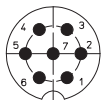

07-a  
0318 07

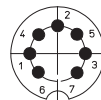

07-b  
0318 07-1

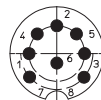

0318 08

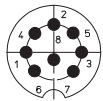

08-a  
0318 08-1

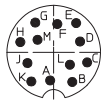



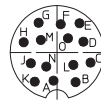



12-a  
0318 12







14-a  
0318 14

Associated products

Counterparts

 0321	 0322	 0322-1
 032200	 0360	 036000

Accessories

 0308 C 02	 0383	 038399
 038899		

- \*a O-ring gasket
- \*b cup-shaped solder terminal
- \*c mounting direction
- \*d contact pin  
Ø 1.5 mm (0318 03–0318 08-1)  
Ø 1.0 mm (0318 12–0318 14)
- \*e port in mounting plate
- \*f provide for suitable sealing of screws

03

0318

Designation	Pole Number	PU (Pieces)	MDQ (Pieces)
0318 03	3	50	100
0318 04	4	50	100
0318 05	5	50	100
0318 05-1	5	50	100
0318 06	6	50	100
0318 07	7	50	100
0318 07-1	7	50	100
0318 08	8	50	100
0318 08-1	8	50	100
0318 12	12	50	100
0318 14	14	50	100

**Packaging:**

in a cardboard box