

New

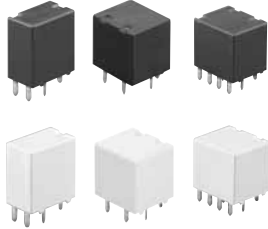

FEATURES

1. Smallest in its class, it is extremely compact at approx. 2/3 the size of previous products.

Compared to our previous miniature type CT relay, both the 1 Form C and 10-pin and 8-pin twin types take up approx. two-thirds the space and volume. This makes them ideal for relay unit miniaturization.

2. Compact and high-capacity 25 A load switching

High capacity control is possible while being compact and capable of motor lock load switching at 25 A, 14 V DC.

3. Pin in Paste* compatible model added

Models compatible with the recently increasing Pin in Paste technique (reflow solder mounting) have been added.

Pin in Paste compatible models are the flux tight type.

* The Pin in Paste method may sometimes be referred to as THR (Through-hole Reflow).

4. Environmental protection specifications

Cadmium-free contacts and use of lead-free solder are standard. Environmental pollutants are not used.

TYPICAL APPLICATIONS

- Powered windows
- Automatic door locks
- Electrically powered mirrors
- Powered sunroofs
- Powered seats
- Lift gates
- Smart J/B related products, etc.

Compliance with RoHS Directive

TYPES

Contact arrangement	Nominal coil voltage	Pick-up voltage (at 20°C 68°F)	Part No.	
			Standard type	Pin in Paste type
1 Form C	12 V DC	Max. 6.5 V DC (Initial)	ACJ1112	ACJ1112P
		Max. 7.2 V DC (Initial)	ACJ1212	ACJ1212P
1 Form C × 2 (8 terminal)		Max. 6.5 V DC (Initial)	ACJ2112	ACJ2112P
		Max. 7.2 V DC (Initial)	ACJ2212	ACJ2212P
1 Form C × 2 (10 terminal)		Max. 6.5 V DC (Initial)	ACJ5112	ACJ5112P
		Max. 7.2 V DC (Initial)	ACJ5212	ACJ5212P

Standard packing; Carton (tube): 70 pcs.; Case: 2,800 pcs. (1 Form C), Carton (tube): 40 pcs.; Case: 1,000 pcs. (8 terminal),
Carton (tube): 35 pcs.; Case: 1,400 pcs. (10 terminal)

RATING

1. Coil data

Nominal coil voltage	Pick-up voltage (at 20°C 68°F)	Drop-out voltage (at 20°C 68°F)	Nominal operating current [±10%] (at 20°C 68°F)	Coil resistance [±10%] (at 20°C 68°F)	Nominal operating power (at 20°C 68°F)	Max. continuous voltage*
12 V DC	Max. 7.2 V DC (Initial)	Min. 1.0 V DC (Initial)	53.3 mA	225Ω	640 mW	10 to 16 V DC
	Max. 6.5 V DC (Initial)	Min. 0.8 V DC (Initial)	66.7 mA	180Ω	800 mW	9 to 16 V DC

* Other usable voltage range types are also available. Please contact us for details.

CJ (ACJ)

2. Specifications

Characteristics	Item	Specifications	
Contact	Arrangement	1 Form C, 1 Form C×2	
	Initial contact resistance (Initial)	N.O.: Typ7mΩ, N.C.: Typ10mΩ (By voltage drop 6 V DC 1 A)	
	Contact material	Ag alloy (Cadmium free)	
Protective construction		Standard type: Sealed type Pin in Paste type: Flux tight type	
Rating	Nominal switching capacity	N.O.: 20A 14V DC, N.C.: 10A 14V DC	
	Max. carrying current (14V DC)	N.O.: 20 A for 1 hour, 30 A for 2 minutes (at 20°C 68°F)	
	Nominal operating power	640 mW (for pick-up voltage max. 7.2 V DC), 800 mW (for pick-up voltage max. 6.5 V DC)	
	Min. switching capacity*1	1A 12V DC	
Electrical characteristics	Initial insulation resistance	Min. 100 MΩ (at 500 V DC)	
	Initial breakdown voltage	Between open contacts	500 Vrms for 1 min. (Detection current: 10mA)
		Between contacts and coil	500 Vrms for 1 min. (Detection current: 10mA)
	Operate time (at nominal voltage)	Max. 10ms (at 20°C 68° F, excluding contact bounce time) (Initial)	
Release time (at nominal voltage)	Max. 10ms (at 20°C 68° F, excluding contact bounce time) (Initial)		
Mechanical characteristics	Shock resistance	Functional	Min. 100 m/s ² {10G} (Half-wave pulse of sine wave: 11ms; detection: 10μs)
		Destructive	Min. 1,000 m/s ² {100G} (Half-wave pulse of sine wave: 6ms)
	Vibration resistance	Functional	10 Hz to 100 Hz, Min. 44.1m/s ² {4.5G} (Detection time: 10μs)
		Destructive	10 Hz to 500 Hz, Min. 44.1m/s ² {4.5G} Time of vibration for each direction; X, Y direction: 2 hours, Z direction: 4 hours
Expected life	Mechanical	Min. 10 ⁷ (at 120 cpm)	
	Electrical	[Standard type] <Resistive load> Min. 10 ⁵ (At nominal switching capacity, operating frequency: 1s ON, 9s OFF) <Motor load> N.O. side: Min. 2×10 ⁵ : at 25 A (inrush), 5 A (steady), 14 V DC; Min. 10 ⁵ : at 25 A 14 V DC (Motor lock) N.C. side: Min. 2×10 ⁵ : at 20 A 14 V DC (brake) (Operating frequency: 0.5s ON, 9.5s OFF) [Pin in Paste type] <Resistive load> Min. 10 ⁵ (At nominal switching capacity, operating frequency: 1s ON, 9s OFF) <Motor load> N.O. side: Min. 10 ⁵ : at 25 A (inrush), 5 A (steady), 14 V DC; Min. 5×10 ⁴ : at 25 A 14 V DC (Motor lock) N.C. side: Min. 10 ⁵ : at 20 A 14 V DC (brake) (Operating frequency: 0.5s ON, 9.5s OFF)	
Conditions	Conditions for operation, transport and storage*2	Ambient temp: -40°C to +85°C -40°F to +185°F Humidity: 5% R.H. to 85% R.H. (Not freezing and condensing at low temperature)	
	Max. operating speed	6 cpm (At nominal switching capacity)	
Unit weight		1 Form C type: approx. 3.5 g .12 oz Twin type: approx. 6.5 g .23 oz	

Notes: *1 This value can change due to the switching frequency, environmental conditions, and desired reliability level, therefore it is recommended to check this with the actual load.

*2 Refer to Conditions for operation, transport and storage mentioned in AMBIENT ENVIRONMENT
Please inquire if you will be using the relay in a high temperature atmosphere (110°C 230°F).

REFERENCE DATA

1-(1). Coil temperature rise (at room temperature)

Sample: ACJ1212, 3pcs
Measured portion: Inside the coil
Contact carrying current: 10A, 15A, 20A
Ambient temperature: 25°C 77°F

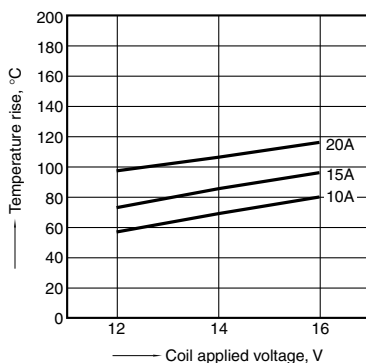

1-(2). Coil temperature rise (at 85°C 185°F)

Sample: ACJ1212, 3pcs
Measured portion: Inside the coil
Contact carrying current: 10A, 15A, 20A
Ambient temperature: 85°C 185°F

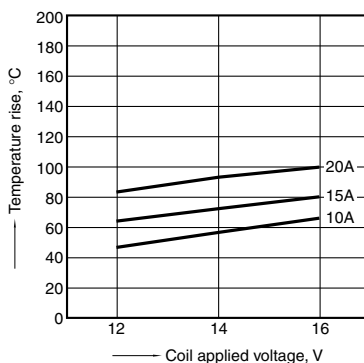

1-(3). Coil temperature rise (at room temperature)

Sample: ACJ2212, 3pcs
Measured portion: Inside the coil
Contact carrying current: 10A, 15A, 20A
Ambient temperature: 25°C 77°F

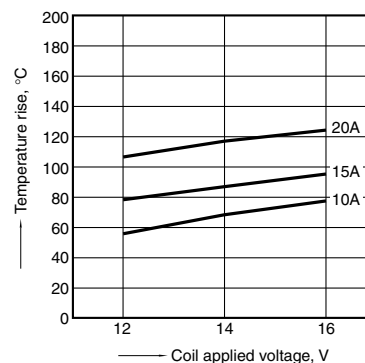

1-(4). Coil temperature rise (at 85°C 185°F)

Sample: ACJ2212, 3pcs
 Measured portion: Inside the coil
 Contact carrying current: 10A, 15A, 20A
 Ambient temperature: 85°C 185°F

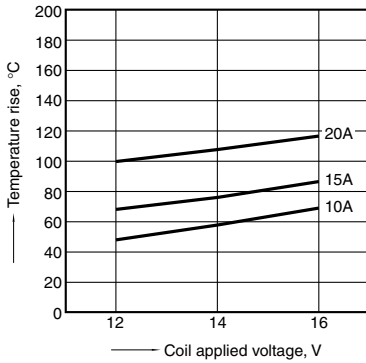

1-(5). Coil temperature rise (at room temperature)

Sample: ACJ5212, 3pcs
 Measured portion: Inside the coil
 Contact carrying current: 10A, 15A, 20A
 Ambient temperature: 25°C 77°F

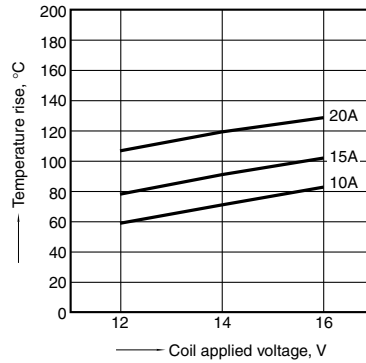

1-(6). Coil temperature rise (at 85°C 185°F)

Sample: ACJ5212, 3pcs
 Measured portion: Inside the coil
 Contact carrying current: 10A, 15A, 20A
 Ambient temperature: 85°C 185°F

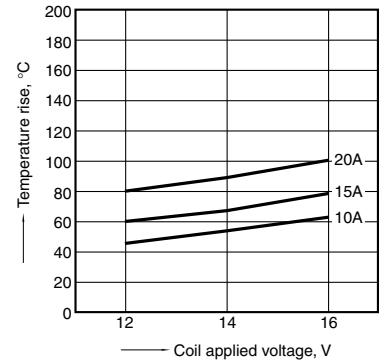

2-(1). Electrical life test (Motor free)

Sample: ACJ2212, 3pcs; Load: Inrush current: 25A/
 Steady current: 5A, Power window motor actual load
 (free condition); Tested voltage: 14V DC; Switching
 frequency: (ON:OFF = 0.5s:9.5s); Switching cycle:
 2x10⁵; Ambient temperature: Room temperature

Circuit

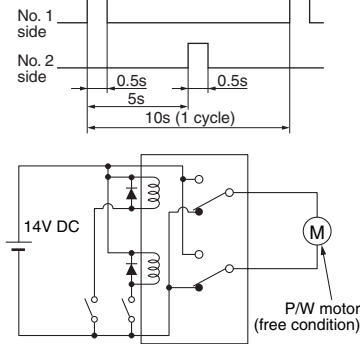

Change of pick-up and drop-out voltage

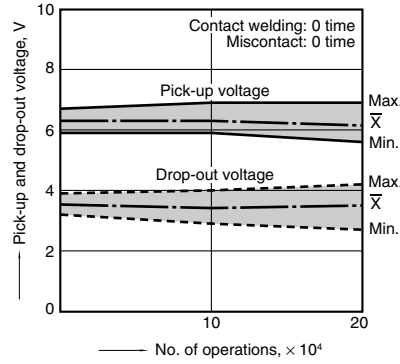

Change of contact resistance

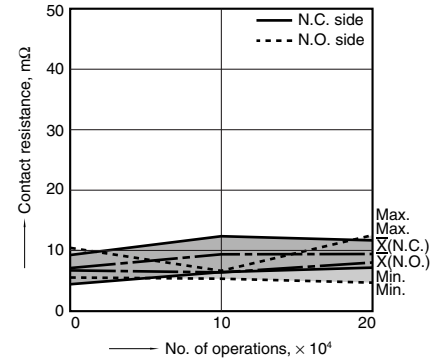

Load current waveform

Inrush current: 25A, Steady current: 6A,
 Brake current: 13A

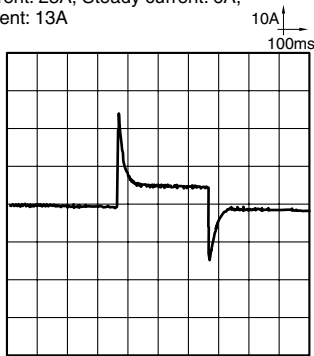

CJ (ACJ)

2-(2). Electrical life test (Motor lock)

Sample: ACJ2212, 3pcs; Load: Steady current: 25A,
Power window motor actual load (lock condition);
Tested voltage: 14V DC; Switching frequency:
(ON:OFF = 0.5s:9.5s); Switching cycle: 10⁵;
Ambient temperature: Room temperature

Circuit

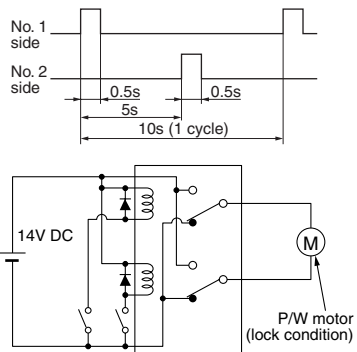

Change of pick-up and drop-out voltage

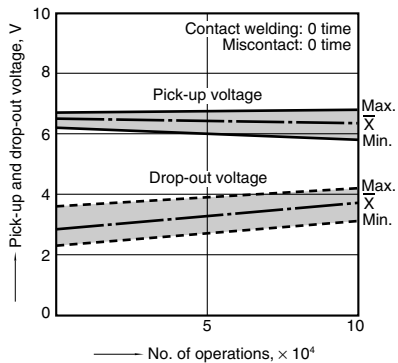

Change of contact resistance

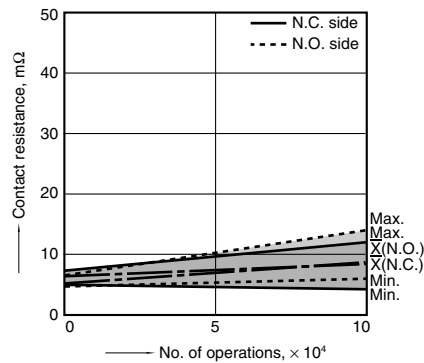

Load current waveform

Current value: 25A

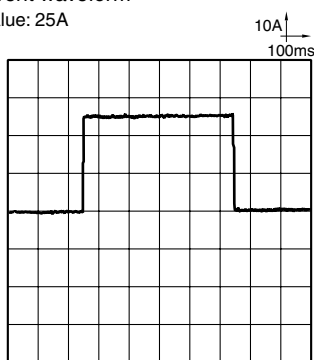

DIMENSIONS (Unit: mm inch)

1. Twin type (8-pin)



External dimensions

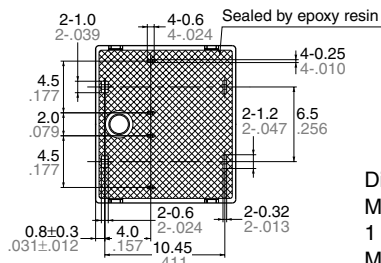
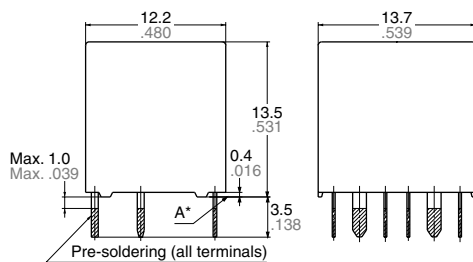

Dimension:
Max. 1mm .039 inch: $\pm 0.1 \pm .004$
1 to 3mm .039 to .118 inch: $\pm 0.2 \pm .008$
Min. 3mm .118 inch: $\pm 0.3 \pm .012$

PC board pattern (Bottom view)

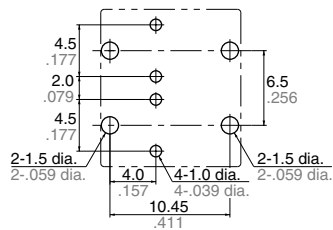

Tolerance: $\pm 0.1 \pm .004$

Schematic (Bottom view)

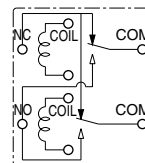

* Dimensions (thickness and width) of terminal specified in this catalog is measured before pre-soldering. Intervals between terminals is measured at A surface level.

2. Twin type (8-pin) Pin in Paste type



External dimensions

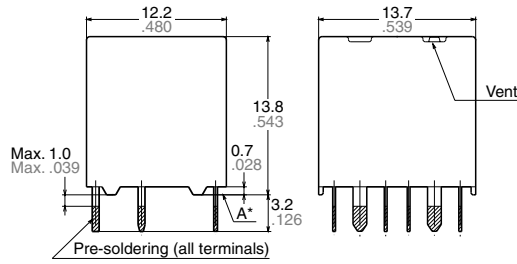

PC board pattern (Bottom view)

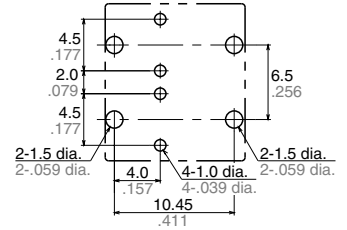

Tolerance: $\pm 0.1 \pm 0.004$

Schematic (Bottom view)

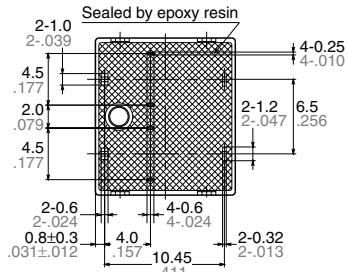
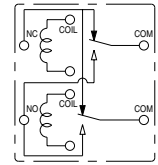

Dimension:
 Max. 1mm .039 inch: $\pm 0.1 \pm 0.004$
 1 to 3mm .039 to .118 inch: $\pm 0.2 \pm 0.008$
 Min. 3mm .118 inch: $\pm 0.3 \pm 0.012$

* Dimensions (thickness and width) of terminal specified in this catalog is measured before pre-soldering. Intervals between terminals is measured at A surface level.

3. Twin type (10-pin) Standard type



External dimensions

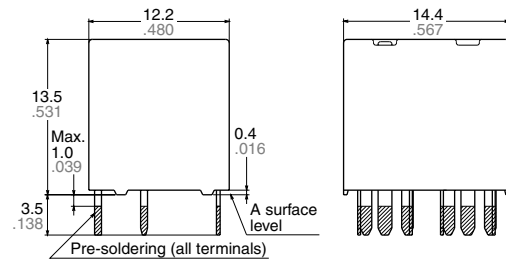

PC board pattern (Bottom view)

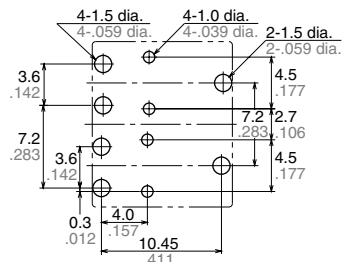

Tolerance: $\pm 0.1 \pm 0.004$

Schematic (Bottom view)

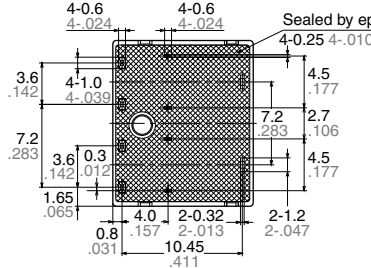
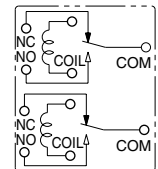

Dimension:
 Max. 1mm .039 inch: $\pm 0.1 \pm 0.004$
 1 to 3mm .039 to .118 inch: $\pm 0.2 \pm 0.008$
 Min. 3mm .118 inch: $\pm 0.3 \pm 0.012$

4. Twin type (10-pin) Pin in Paste type



External dimensions

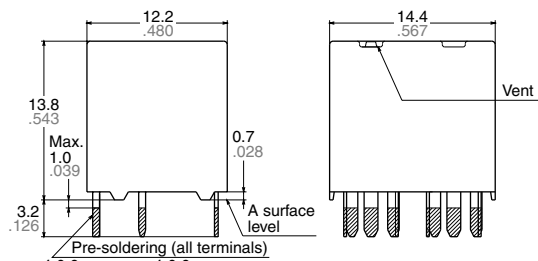

PC board pattern (Bottom view)

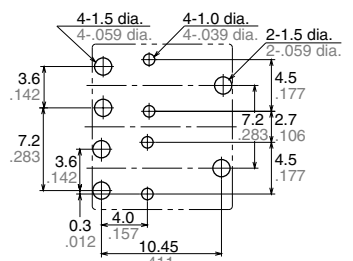

Tolerance: $\pm 0.1 \pm 0.004$

Schematic (Bottom view)

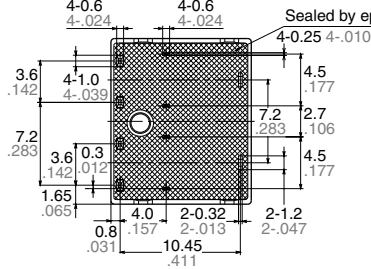
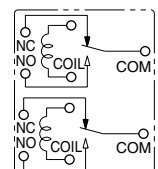

Dimension:
 Max. 1mm .039 inch: $\pm 0.1 \pm 0.004$
 1 to 3mm .039 to .118 inch: $\pm 0.2 \pm 0.008$
 Min. 3mm .118 inch: $\pm 0.3 \pm 0.012$

CJ (ACJ)

5. Slim 1 Form C Standard type



External dimensions

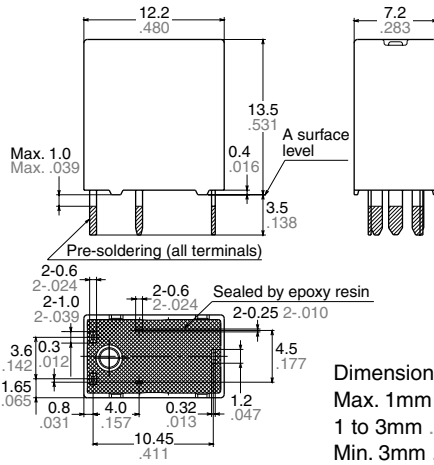

Dimension:
 Max. 1mm .039 inch: $\pm 0.1 \pm .004$
 1 to 3mm .039 to .118 inch: $\pm 0.2 \pm .008$
 Min. 3mm .118 inch: $\pm 0.3 \pm .012$

PC board pattern (Bottom view)

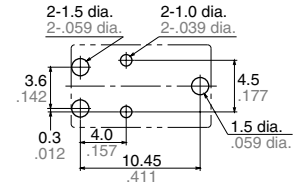

Tolerance: $\pm 0.1 \pm .004$

Schematic (Bottom view)

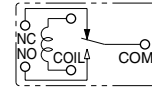

6. Slim 1 Form C Pin in Paste type



External dimensions

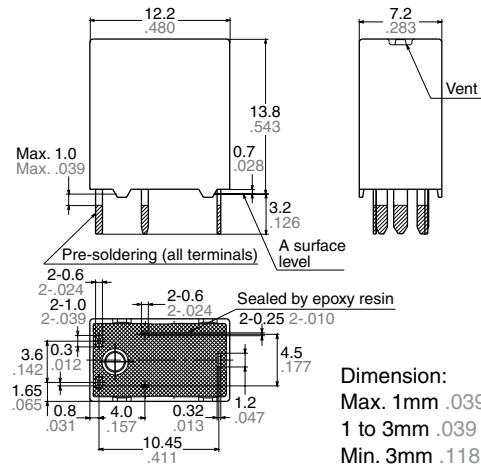

Dimension:
 Max. 1mm .039 inch: $\pm 0.1 \pm .004$
 1 to 3mm .039 to .118 inch: $\pm 0.2 \pm .008$
 Min. 3mm .118 inch: $\pm 0.3 \pm .012$

PC board pattern (Bottom view)

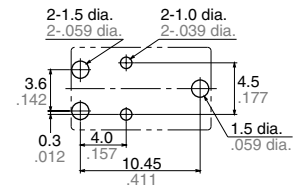

Tolerance: $\pm 0.1 \pm .004$

Schematic (Bottom view)

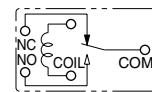

EXAMPLE OF CIRCUIT

Forward/reverse control circuits of DC motor (for 1 Form C \times 2 (8 terminal) type)

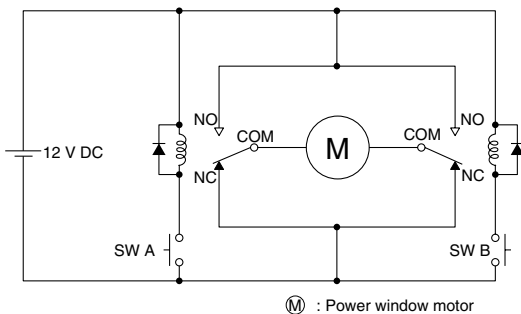

For Cautions for Use, see Relay Technical Information.