

SMT Common Mode Choke

PA4339.XXXNLT Series



- ⌚ **Height:** 3.8 mm MAX
- ⌚ **Footprint:** 7.5 mm x 6.5 mm MAX
- ⌚ **Rated Current:** up to 9.0 A
- ⌚ **Rated Voltage (MAX):** 80Vdc between windings.

Electrical Specifications @ 25°C - Operating Temperature -40°C to 125°C

Part Number	Inductance (uH ± 50%)	Rated Current (A)	DCR/Winding (mOHms Max)	Impedance @ 100 MHz (ohms)		SRF (MHz)
				MIN	TYP	TYP
PA4339.101NLT	1.8	9.0	10	100	140	200
PA4339.301NLT	2.8	5.0	10	225	300	138
PA4339.501NLT	4.0	5.0	10	275	350	124
PA4339.701NLT	5.0	4.0	15	500	700	108
PA4339.102NLT	8.0	3.0	17	800	1020	93
PA4339.132NLT	9.0	2.5	21	910	1300	77

Notes:

- The temperature of the component (ambient plus temperature rise) must be within the stated operating temperature range.
- The current rating (I_{rated}) is based upon the temperature rise of the component and represents the rms current which will cause a typical temperature rise of 40°C.
- Inductance value is only for reference and is measured at 100kHz, 100Vrms.

Mechanical

Schematic

PA4339.XXXNLT

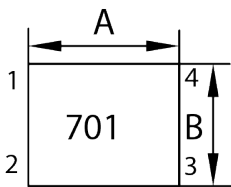

FINAL LAYOUT

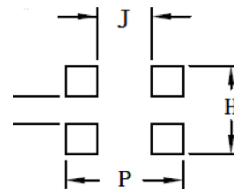
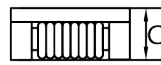
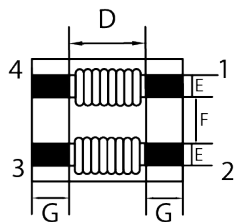

SUGGESTED PAD LAYOUT

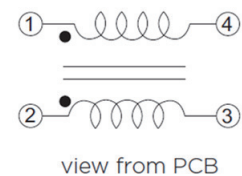

SERIES	A	B	C	D	E	F	G	I	H	J	P
PA4339.XXXNLT	7.0±0.5mm	6.0±0.5mm	MAX 3.8 mm	3.5mm	1.5±0.2mm	1.5±0.2mm	1.75±0.2mm	1.5mm	4.5mm	2.5mm	6.9mm

All Dimensions in mm.

SMT Common Mode Choke

PA4339.XXXNLT Series

PA4339.XXXNLT, Typical Impedance versus Frequency

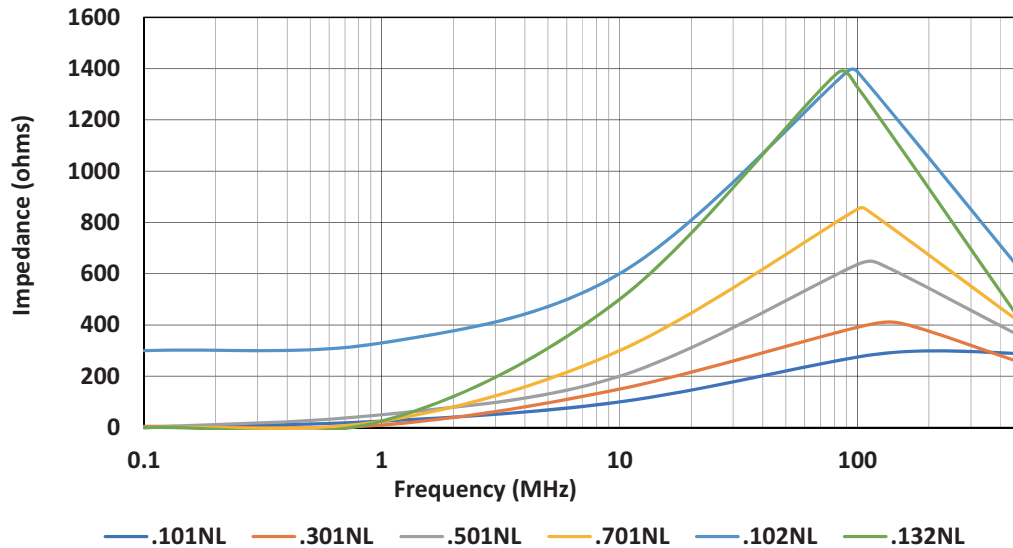

TAPE & REEL INFO

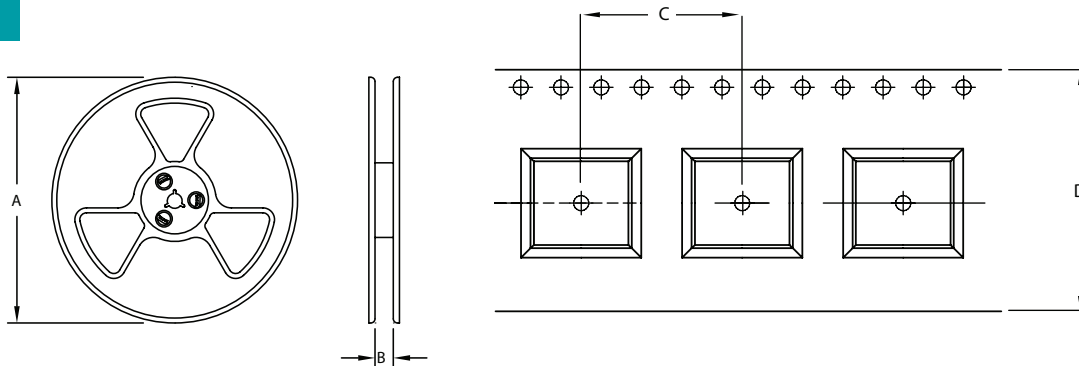

SURFACE MOUNTING TYPE, REEL/TAPE LIST

SERIES	REEL SIZE (mm)		TAPE SIZE (mm)		QTY
	A	B	C	D	PCS/REEL
PA4339.XXXNLT	Ø330	16.4	12.0±0.1	16.0±0.3	1500

For More Information

Pulse Worldwide Headquarters

15255 Innovation Drive Ste 100
San Diego, CA 92128
U.S.A.

Pulse Europe

Pulse Electronics GmbH
Am Rottland 12
58540 Meinerzhagen
Germany

Pulse China Headquarters

Pulse Electronics (Shenzhen) CO., LTD
D708, Shenzhen Academy of
Aerospace Technology,
The 10th Keji South Road,
Nanshan District, Shenzhen,
P.R. China 518057

Pulse North China

Room 2704/2705
Super Ocean Finance Ctr.
2067 Yan An Road West
Shanghai 200336
China

Pulse South Asia

3 Fraser Street
0428 DUO Tower
Singapore 189352

Pulse North Asia

1F., No.111 Xiyuan Rd
Zhongli City
Taoyuan City 32057
Taiwan (R.O.C)

Tel: 858 674 8100
Fax: 858 674 8262

Tel: 49 2354 777 100
Fax: 49 2354 777 168

Tel: 86 755 33966678
Fax: 86 755 33966700

Tel: 86 21 62787060
Fax: 86 2162786973

Tel: 65 6287 8998
Fax: 65 6280 0080

Tel: 886 3 4356768
Fax: 886 3 4356820

Performance warranty of products offered on this data sheet is limited to the parameters specified. Data is subject to change without notice. Other brand and product names mentioned herein may be trademarks or registered trademarks of their respective owners. © Copyright, 2018. Pulse Electronics, Inc. All rights reserved.

Mouser Electronics

Authorized Distributor

Click to View Pricing, Inventory, Delivery & Lifecycle Information:

Pulse:

[PA4339.101NLT](#) [PA4339.102NLT](#) [PA4339.132NLT](#) [PA4339.301NLT](#) [PA4339.501NLT](#) [PA4339.701NLT](#)