

6-Channel, 210-W, Digital-Amplifier Power Stage

FEATURES

- **Total Output Power @ 10% THD+N**
 - 5x30 W @ 6 Ω + 1x60 W @ 3 Ω
- **105-dB SNR (A-Weighted)**
- **0.07% THD+N @ 1 W**
- **Power Stage Efficiency > 90% Into Recommended Loads (SE)**
- **Integrated Self-Protection Circuits**
 - Undervoltage
 - Overtemperature
 - Overload
 - Short Circuit
- **Integrated Active-Bias Control to Avoid DC Pop**
- **Thermally Enhanced 44-Pin HTSSOP Package**
- **EMI-Compliant When Used With Recommended System Design**

APPLICATIONS

- DVD Receiver
- Home Theater in a Box

DESCRIPTION

The TAS5186A is a high-performance, six-channel, digital-amplifier power stage with an improved protection system. The TAS5186A is capable of driving a 6-Ω, single-ended load up to 30 W per each front/satellite channel and a 3-Ω, single-ended subwoofer greater than 60 W at 10% THD+N performance.

A low-cost, high-fidelity audio system can be built using a TI chipset comprising a modulator (e.g., TAS5086) and the TAS5186A. This device does not require power-up sequencing because of the internal power-on reset.

The TAS5186A requires only simple passive demodulation filters on its outputs to deliver high-quality, high-efficiency audio amplification. The device efficiency of the TAS5186A is greater than 90% when driving 6-Ω satellites and a 3-Ω subwoofer speaker.

The TAS5186A has an innovative protection system integrated on-chip, safeguarding the device against a wide range of fault conditions that could damage the system. These safeguards are short-circuit protection, overload protection, undervoltage protection, and overtemperature protection. The TAS5186A has a new proprietary current-limiting circuit that reduces the possibility of device shutdown during high-level music transients. A new programmable overcurrent detector allows the use of lower-cost inductors in the demodulation output filter.

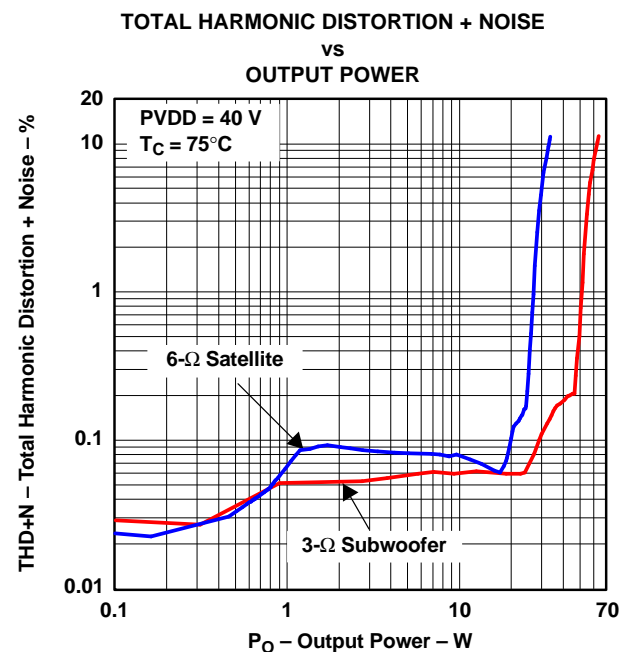

Please be aware that an important notice concerning availability, standard warranty, and use in critical applications of Texas Instruments semiconductor products and disclaimers thereto appears at the end of this data sheet.

PowerPAD is a trademark of Texas Instruments.



These devices have limited built-in ESD protection. The leads should be shorted together or the device placed in conductive foam during storage or handling to prevent electrostatic damage to the MOS gates.

GENERAL INFORMATION

TERMINAL ASSIGNMENT

The TAS5186A is available in a thermally enhanced 44-pin HTSSOP PowerPAD™ package. The heat slug is located on the top side of the device for convenient thermal coupling to a heatsink.

**DDV PACKAGE
(TOP VIEW)**

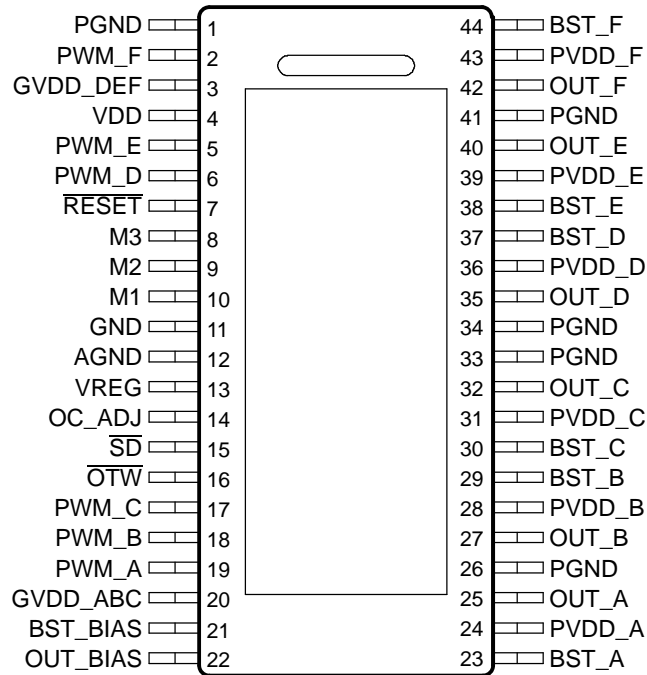

P0016-03

GENERAL INFORMATION (continued)
TERMINAL FUNCTIONS

TERMINAL		TYPE ⁽¹⁾	DESCRIPTION
NAME	NO.		
AGND	12	P	Analog ground
BST_A	23	P	HS bootstrap supply (BST), capacitor to OUT_A required
BST_B	29	P	HS bootstrap supply (BST), external capacitor to OUT_B required
BST_BIAS	21	P	BIAS bootstrap supply, external capacitor to OUT_BIAS required
BST_C	30	P	HS bootstrap supply (BST), external capacitor to OUT_C required
BST_D	37	P	HS bootstrap supply (BST), external capacitor to OUT_D required
BST_E	38	P	HS bootstrap supply (BST), external capacitor to OUT_E required
BST_F	44	P	HS bootstrap supply (BST), external capacitor to OUT_F required
GND	11	P	Chip ground
GVDD_ABC	20	P	Gate drive voltage supply
GVDD_DEF	3	P	Gate drive voltage supply
M1	10	I	Mode selection pin
M2	9	I	Mode selection pin
M3	8	I	Mode selection pin
OC_ADJ	14	O	Overcurrent threshold programming pin, resistor to ground required
OTW	16	O	Overtemperature warning open-drain output signal, active-low
OUT_A	25	O	Output, half-bridge A, satellite
OUT_B	27	O	Output, half-bridge B, satellite
OUT_BIAS	22	O	BIAS half-bridge output pin
OUT_C	32	O	Output, half-bridge C, subwoofer
OUT_D	35	O	Output, half-bridge D, satellite
OUT_E	40	O	Output, half-bridge E, satellite
OUT_F	42	O	Output, half-bridge F, satellite
PGND	1, 26, 33, 34, 41	P	Power ground
PVDD_A	24	P	Power-supply input for half-bridge A
PVDD_B	28	P	Power-supply input for half-bridge B
PVDD_C	31	P	Power-supply input for half-bridge C
PVDD_D	36	P	Power-supply input for half-bridge D
PVDD_E	39	P	Power-supply input for half-bridge E
PVDD_F	43	P	Power-supply input for half-bridge F
PWM_A	19	I	PWM input signal for half-bridge A
PWM_B	18	I	PWM input signal for half-bridge B
PWM_C	17	I	PWM input signal for half-bridge C
PWM_D	6	I	PWM input signal for half-bridge D
PWM_E	5	I	PWM input signal for half-bridge E
PWM_F	2	I	PWM input signal for half-bridge F
RESET	7	I	Reset signal (active-low logic)
SD	15	O	Shutdown open-drain output signal, active-low
VDD	4	P	Power supply for digital voltage regulator
VREG	13	O	Digital regulator supply filter pin, output

(1) I = input; O = output; P = power

Table 1. MODE Selection Pins

MODE PINS ⁽¹⁾		MODE	
M2	M3	NAME	DESCRIPTION
0	0	2.1 mode	Channels A, B, and C enabled; channels D, E, and F disabled
0	1	5.1 mode	All channels enabled
1	0/1	Reserved	

(1) M1 must always be connected to GND. 0 indicates a pin connected to GND; 1 indicates a pin connected to VREG.

PACKAGE HEAT DISSIPATION RATINGS⁽¹⁾

PARAMETER	TAS5186ADDV
$R_{\theta JC}$ (°C/W)—1 satellite (sat.) FET only	10.3
$R_{\theta JC}$ (°C/W)—1 subwoofer (sub.) FET only	5.2
$R_{\theta JC}$ (°C/W)—1 sat. half-bridge	5.2
$R_{\theta JC}$ (°C/W)—1 sub. half-bridge	2.6
$R_{\theta JC}$ (°C/W)—5 sat. half-bridges + 1 sub.	1.74
Typical pad area ⁽²⁾	34.9 mm ²

(1) JC is junction-to-case, CH is case-to-heatsink.

(2) $R_{\theta CH}$ is an important consideration. Assume a 2-mil thickness of typical thermal grease between the pad area and the heatsink. The $R_{\theta CH}$ with this condition is typically 2°C/W for this package.

ABSOLUTE MAXIMUM RATINGS

over operating free-air temperature range (unless otherwise noted)⁽¹⁾

TAS5186A	
VDD to AGND	–0.3 V to 13.2 V
GVDD_X to AGND	–0.3 V to 13.2 V
PVDD_X to PGND_X ⁽²⁾	–0.3 V to 50 V
OUT_X to PGND_X ⁽²⁾	–0.3 V to 50 V
BST_X to PGND_X ⁽²⁾	–0.3 V to 63.2 V
VREG to AGND	–0.3 V to 4.2 V
PGND to GND	–0.3 V to 0.3 V
PGND to AGND	–0.3 V to 0.3 V
GND to AGND	–0.3 V to 0.3 V
PWM_X, OC_ADJ, M1, M2, M3 to AGND	–0.3 V to 4.2 V
RESET, SD, OTW to AGND	–0.3 V to 7 V
Maximum operating junction temperature range (T_J)	0 to 125°C
Storage temperature	–40°C to 125°C
Lead temperature – 1,6 mm (1/16 inch) from case for 10 seconds	260°C
Minimum PWM pulse duration, low	30 ns

(1) Stresses beyond those listed under *absolute maximum ratings* may cause permanent damage to the device. These are stress ratings only, and functional operation of the device at these or any other conditions beyond those indicated under *recommended operating conditions* is not implied. Exposure to absolute-maximum-rated conditions for extended periods may affect device reliability.

(2) These voltages represent the dc voltage + peak ac waveform measured at the terminal of the device in all conditions.

TYPICAL SYSTEM DIAGRAM

A schematic diagram for a typical system is appended at the end of the data sheet.

FUNCTIONAL BLOCK DIAGRAM

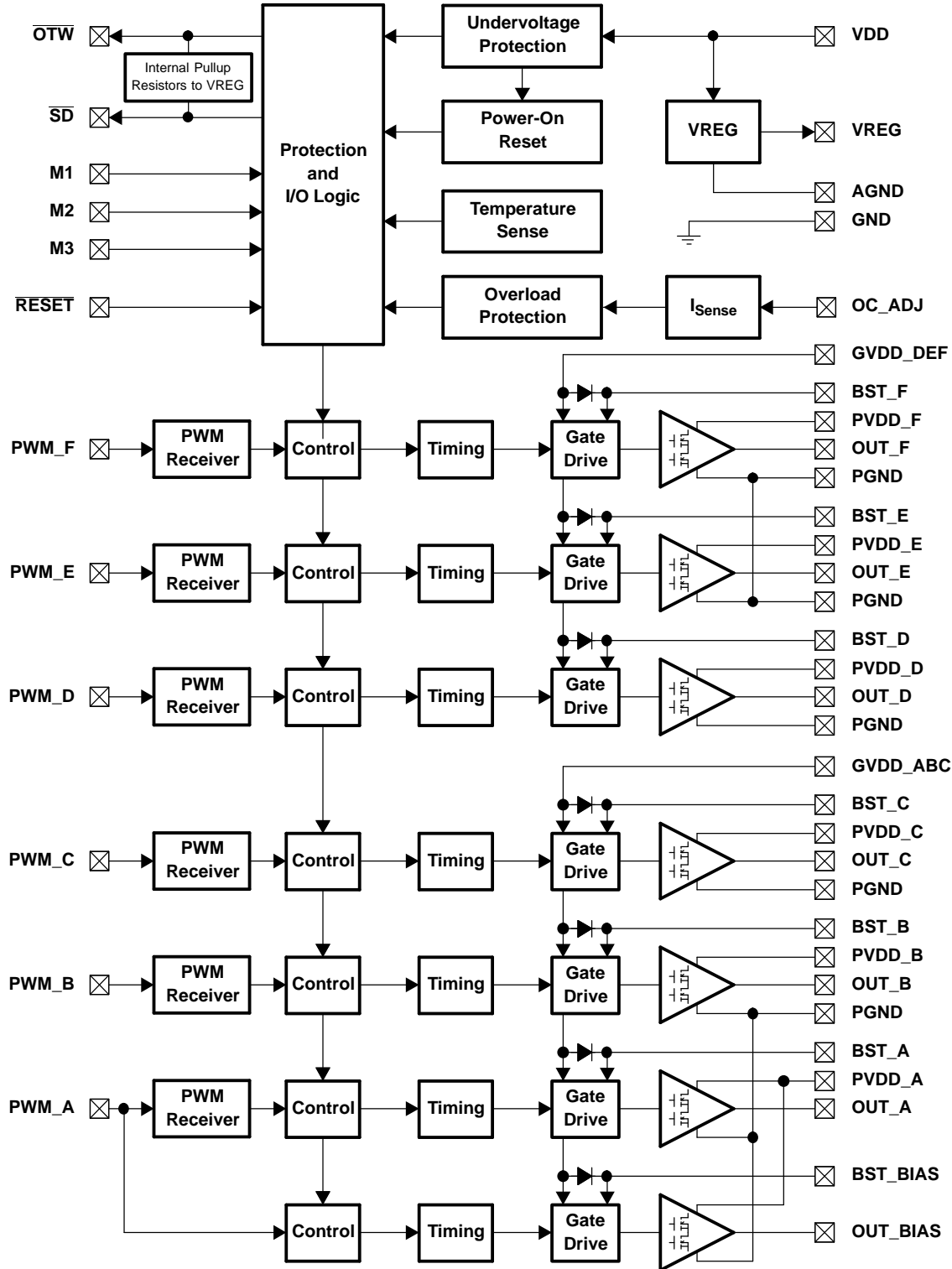

B0034-03

RECOMMENDED OPERATING CONDITIONS

			MIN	TYP	MAX	UNIT
PVDD_X	Half-bridge supply, SE	DC supply voltage at pin(s)	0		40	V
GVDD	Gate drive and guard ring supply voltage	DC voltage at pin(s)	10.8	12	13.2	V
VDD	Digital regulator supply	DC supply voltage at pin	10.8	12	13.2	V
VPU	Pullup voltage supply	Any value of R _{PU,EXT} within recommended range	3	5	5.5	V
R _{L,SAT}	Resistive load impedance, satellite channels ⁽¹⁾	Recommended demodulation filter	4	6		Ω
R _{L,SUB}	Resistive load impedance, subwoofer channel	Recommended demodulation filter	2.25	3		Ω
L _{output}	Demodulation filter inductance	Minimum output inductance under short-circuit condition	5	22		μH
C _{output,sat}	Demodulation filter capacitance			1		μF
C _{output,sub}	Demodulation filter capacitance			1		μF
F _{PWM}	PWM frame rate		192	384	432	kHz

(1) Load impedance outside range listed might cause shutdown due to OLP, OTE, or NLP.

AUDIO SPECIFICATION

PVDD_X = 40 V, GVDD = 12 V, audio frequency = 1 kHz, AES17 measurement filter, F_{PWM} = 384 kHz, case temperature = 75°C. Audio performance is recorded as a chipset, using TAS5086 PWM processor with an effective modulation index limit of 97%. All performance is in accordance with the foregoing specifications and recommended operating conditions unless otherwise specified.

PARAMETER		CONDITIONS	MIN	TYP	MAX	UNIT
P _{O,sat}	Power output per satellite channel	R _L = 6 Ω, 10% THD, clipped input signal		30		W
		R _L = 8 Ω, 10% THD, clipped input signal		25		
		R _L = 6 Ω, 0 dBFS, unclipped input signal		25		
		R _L = 8 Ω, 0 dBFS, unclipped input signal		20		
P _{O,sub}	Power output, subwoofer	R _L = 3 Ω, 10% THD, clipped input signal		60		W
		R _L = 4 Ω, 10% THD, clipped input signal		52		
		R _L = 3 Ω, 0 dBFS, unclipped input signal		50		
		R _L = 4 Ω, 0 dBFS, unclipped input signal		40		
THD + N	Total harmonic distortion + noise, satellite	R _L = 6 Ω, P _O = 25 W		0.3%		
		R _L = 6 Ω, 1 W		0.07%		
	Total harmonic distortion + noise, subwoofer	R _L = 3 Ω, P _O = 50 W		0.5%		
		R _L = 3 Ω, 1 W		0.05%		
V _n	Output integrated noise, satellite	A-weighted		55		μV
	Output integrated noise, subwoofer	A-weighted		60		
SNR	System signal-to-noise ratio	A-weighted		105		dB
DNR	Dynamic range ⁽¹⁾	A-weighted, –60 dBFS input signal, measured with TAS5086 PWM processor		105		dB
P _{idle}	Power dissipation due to idle losses (IPVDDX)	P _O = 0 W, all channels running 5.1 mode ⁽²⁾ , 22-μH Kwang-Sung inductors (see schematic for information)		4.5		W
		P _O = 0 W, 2.1 mode, 22-μH Kwang-Sung inductors (see schematic for information)		2.2		W

(1) SNR is calculated relative to 0-dBFS input level.

(2) Actual system idle losses are affected by core losses of output inductors.

ELECTRICAL CHARACTERISTICS

$F_{PWM} = 384$ kHz, $V_{VDD} = 12$ V, $V_{DD} = 12$ V, T_C (case temperature) = 75°C, unless otherwise noted. All performance is in accordance with recommended operating conditions, unless otherwise specified.

SYMBOL	PARAMETER	CONDITIONS	MIN	TYP	MAX	UNIT	
INTERNAL VOLTAGE REGULATOR AND CURRENT CONSUMPTION							
VREG	Voltage regulator, only used as reference node	VDD = 12 V	3	3.3	3.6	V	
IVDD	VDD supply current	Operating, 50% duty cycle		7	20	mA	
		Idle, reset mode		6	16		
IGVDD_X	Gate supply current per half-bridge	50% duty cycle		5	22	mA	
		Idle, reset mode		1	3		
IPVDD_X	Half-bridge idle current	50% duty cycle, without output filter or load, 5.1 mode. 22- μ H Kwang-Sung inductors		110		mA	
		50% duty cycle, without output filter or load, 2.1 mode. 22- μ H Kwang-Sung inductors		60			
OUTPUT STAGE MOSFETS							
$R_{DSon, LS Sat}$	Drain-to-source resistance, low side, satellite	$T_J = 25^\circ\text{C}$, includes metallization resistance		210		m Ω	
$R_{DSon, HS Sat}$	Drain-to-source resistance, high side, satellite	$T_J = 25^\circ\text{C}$, includes metallization resistance		210		m Ω	
$R_{DSon, LS Sub}$	Drain-to-source resistance, low side, subwoofer	$T_J = 25^\circ\text{C}$, includes metallization resistance		110		m Ω	
$R_{DSon, HS Sub}$	Drain-to-source resistance, high side, subwoofer	$T_J = 25^\circ\text{C}$, includes metallization resistance		110		m Ω	
I/O PROTECTION							
$V_{UVP, G}$	Undervoltage protection limit GVDD_X			10		V	
$V_{UVP, hyst}^{(1)}$	Undervoltage protection hysteresis			250		mV	
OTW ⁽¹⁾	Overtemperature warning			125		°C	
OTW _{hyst} ⁽¹⁾	Temperature drop needed below OTW temp. for OTW to be inactive after the OTW event			25		°C	
OTE ⁽¹⁾	Overtemperature error			155		°C	
OTE _{HYST} ⁽¹⁾	Temperature drop needed below OTE temp. for \overline{SD} to be released after the OTE event			25		°C	
OLCP	Overload protection counter		1.25			ms	
I_{OC}	Overcurrent limit protection, satellite	Rocp = 18 k Ω		4.5		A	
	Overcurrent limit protection, subwoofer	Rocp = 18 k Ω		8		A	
I_{OCT}	Overcurrent response time			210		ns	
Rocp	OC programming resistor range	Resistor tolerance = 5%		18		k Ω	
STATIC DIGITAL SPECIFICATION							
V_{IH}	High-level input voltage	PWM_X, M1, M2, M3, \overline{RESET}		2		V	
V_{IL}	Low-level input voltage				0.8		
I_{LEAK}	Input leakage current	Static condition	-80		80	μ A	
OTW/SHUTDOWN (SD)							
R_{INT_PU}	Internal pullup resistor to DREG (3.3 V) for \overline{SD} and OTW			26		k Ω	
V_{OH}	High-level output voltage	Internal pullup resistor only		3	3.3	3.6	V
		External pullup: 4.7-k Ω resistor to 5 V		4.5		5	
V_{OL}	Low-level output voltage	$I_O = 4$ mA		0.2	0.4		
FANOUT	Device fanout OTW, \overline{SD}	No external pullup		30		Devices	

(1) Specified by design.

TYPICAL CHARACTERISTICS, 5.1 MODE

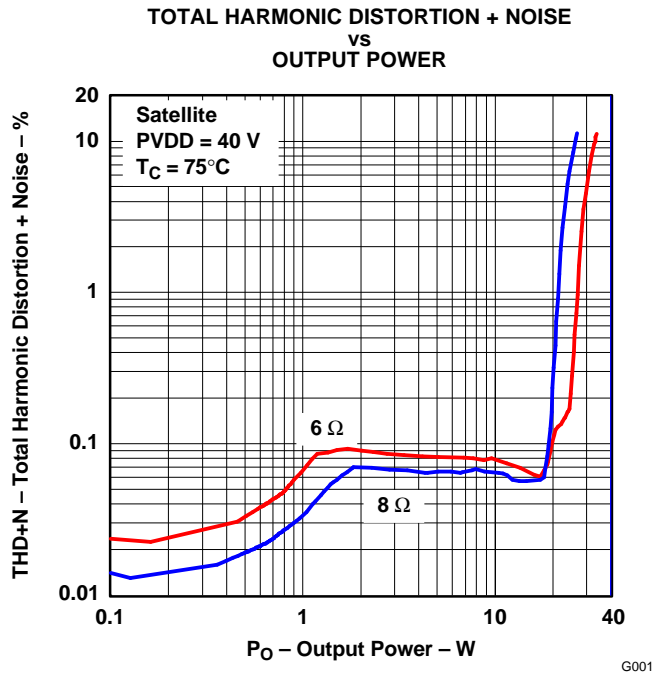

Figure 1.

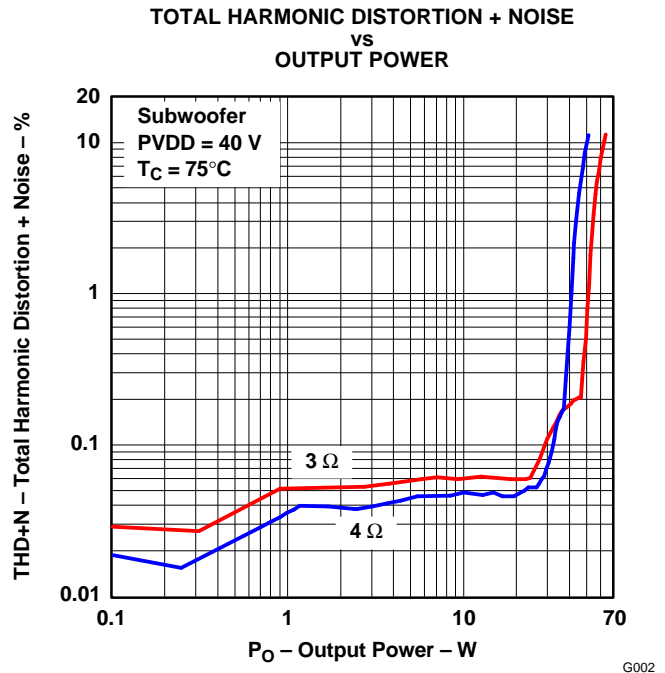

Figure 2.

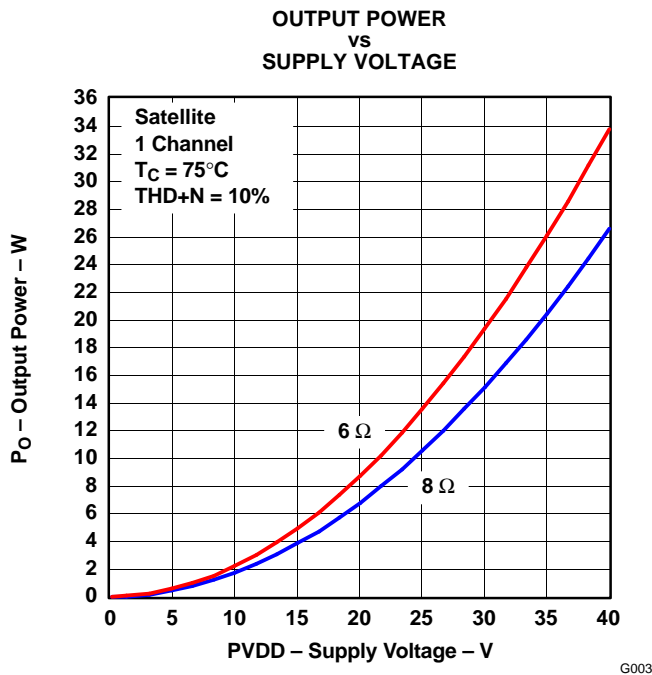

Figure 3.

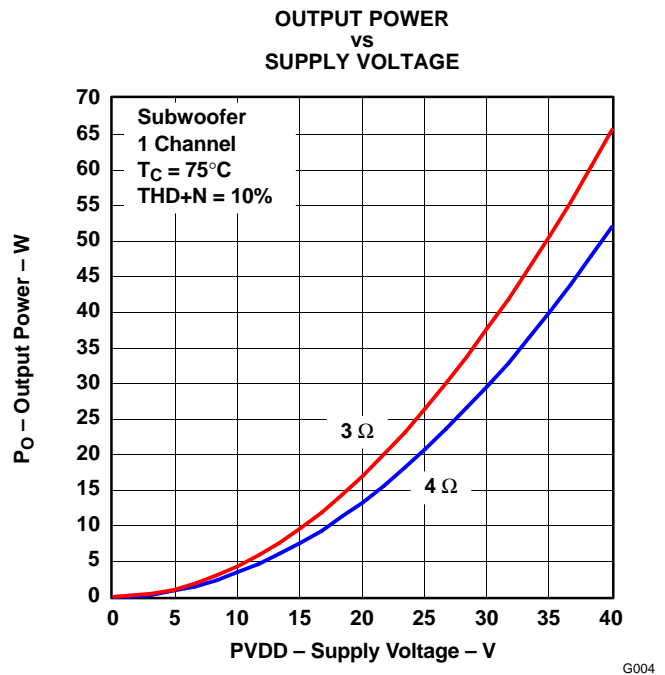
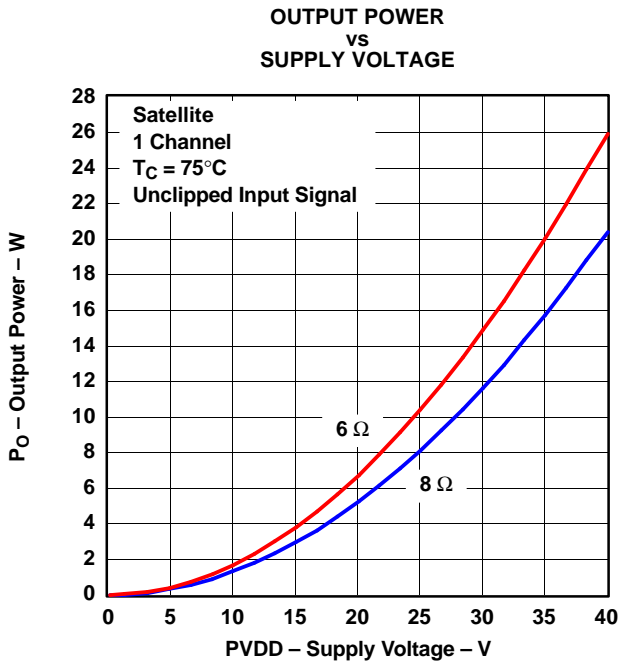

Figure 4.

TYPICAL CHARACTERISTICS, 5.1 MODE (continued)



G005

Figure 5.

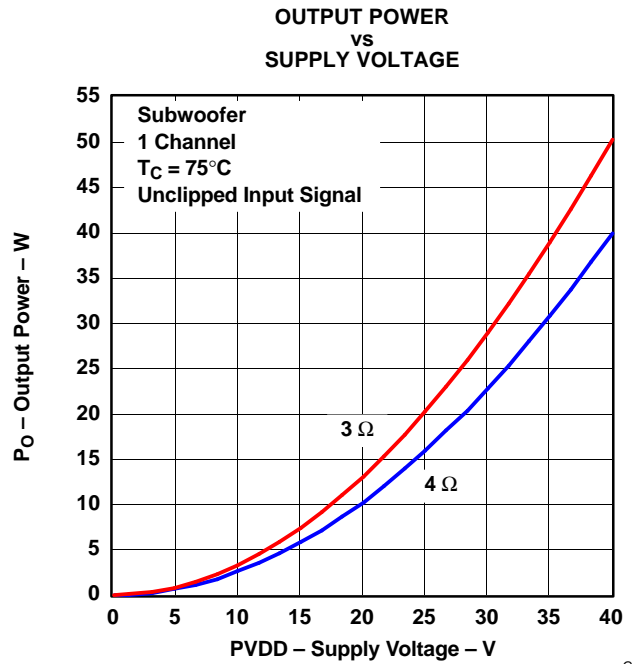

G006

Figure 6.

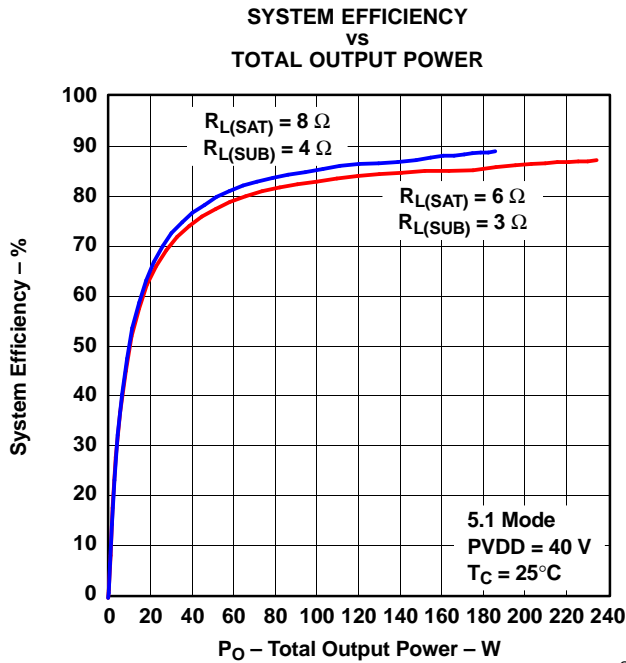

G007

Figure 7.

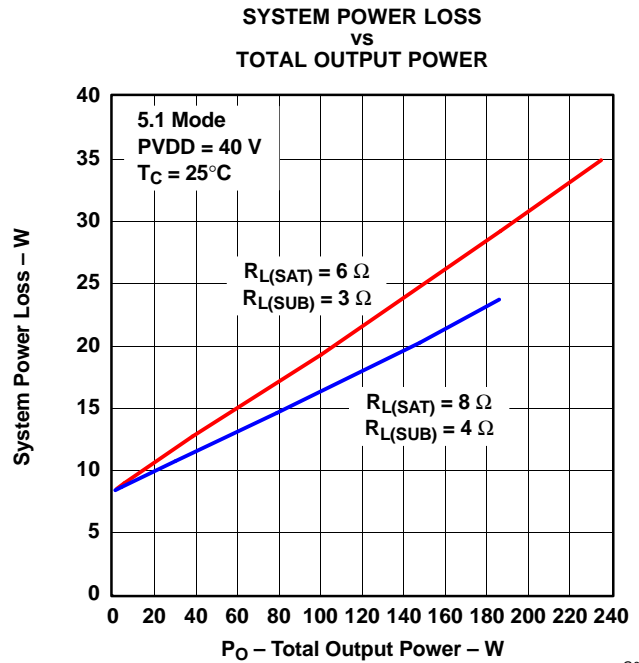

G008

Figure 8.

TYPICAL CHARACTERISTICS, 5.1 MODE (continued)

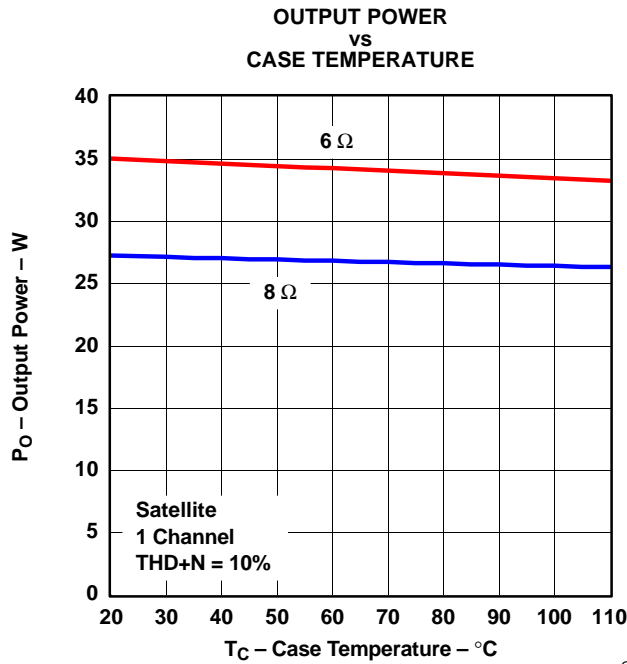

Figure 9.

G009

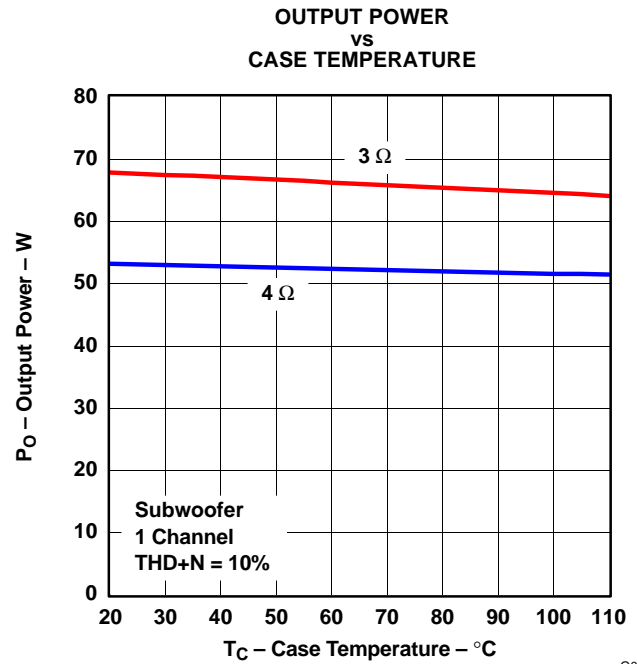

Figure 10.

G010

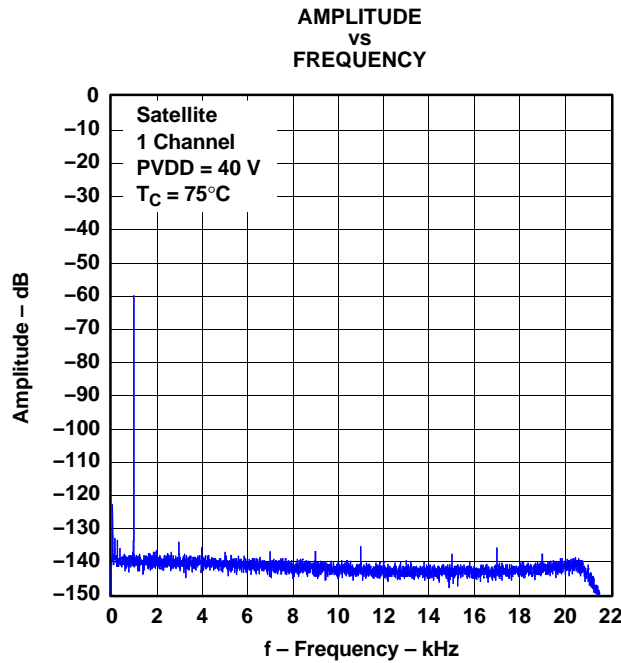

Figure 11.

G011

THEORY OF OPERATION

POWER SUPPLIES

To facilitate system design, the TAS5186A needs only a 12-V supply in addition to a typical 39-V power-stage supply. An internal voltage regulator provides suitable voltage levels for the digital and low-voltage analog circuitry. Additionally, all circuitry requiring a floating voltage supply, e.g., the high-side gate drive, is accommodated by built-in bootstrap circuitry requiring only a few external capacitors.

In order to provide outstanding electrical and acoustic characteristics, the PWM signal path including gate drive and output stage is designed as identical, independent half-bridges. For this reason, each half-bridge has separate bootstrap pins (BST_X) and power-stage supply pins (PVDD_X). Furthermore, an additional pin (VDD) is provided as power supply for all common circuits. Although supplied from the same 12-V source, it is highly recommended to separate GVDD_X and VDD on the printed-circuit board (PCB) by RC filters (see application diagram for details). These RC filters provide the recommended high-frequency isolation. Special attention should be paid to placing all decoupling capacitors as close to their associated pins as possible. In general, inductance between the power-supply pins and decoupling capacitors must be avoided. (See reference board documentation for additional information.)

For a properly functioning bootstrap circuit, a small ceramic capacitor must be connected from each bootstrap pin (BST_X) to the power-stage output pin (OUT_X). When the power-stage output is low, the bootstrap capacitor is charged through an internal diode connected between the gate-drive power-supply pin (GVDD_X) and the bootstrap pin. When the power-stage output voltage is high, the bootstrap capacitor voltage is shifted above the output voltage potential and thus provides a suitable voltage supply for the high-side gate driver. In an application with PWM switching frequencies in the range 352 kHz to 384 kHz, it is recommended to use 33-nF ceramic capacitors, size 0603 or 0805, for the bootstrap capacitor. These 33-nF capacitors ensure sufficient energy storage, even during minimal PWM duty cycles, to keep the high-side power stage FET (LDMOS) fully started during all of the remaining part of the PWM cycle. In an application running at a reduced switching frequency, generally 250 kHz to 192 kHz, the bootstrap capacitor might need to be increased in value. Special attention should be paid to the power-stage power supply; this includes component selection, PCB placement and routing. As indicated, each half-bridge has independent power-stage supply pins (PVDD_X). For optimal electrical performance, EMI compliance, and system

reliability, it is important that each PVDD_X pin is decoupled with a 100-nF ceramic capacitor placed as close as possible to each supply pin on the same side of the PCB as the TAS5186A. It is recommended to follow the PCB layout of the TAS5186A reference design. For additional information on the recommended power supply and required components, see the application diagrams given in this data sheet. The 12-V supply should be powered from a low-noise, low-output-impedance voltage regulator. Likewise, the 39-V power-stage supply is assumed to have low output impedance and low noise. The power-supply sequence is not critical due to the internal power-on-reset circuit. Moreover, the TAS5186A is fully protected against erroneous power-stage turnon due to parasitic gate charging. Thus, voltage-supply ramp rates (dv/dt) are typically noncritical.

SYSTEM POWER-UP/DOWN SEQUENCE

The TAS5186A does not require a power-up sequence. The outputs of the H-bridge remain in a high-impedance state until the gate-drive supply voltage (GVDD_X) and VDD voltage are above the undervoltage protection (UVP) voltage threshold (see the *Electrical Characteristics* section of this data sheet). Although not specifically required, it is recommended to hold $\overline{\text{RESET}}$ in a low state while powering up the device.

When the TAS5186A is being used with TI PWM modulators such as the TAS5086, no special attention to the state of $\overline{\text{RESET}}$ is required, provided that the chipset is configured as recommended.

Powering Down

The TAS5186A does not require a power-down sequence. The device remains fully operational as long as the gate-drive supply (GVDD_X) voltage and VDD voltage are above the undervoltage protection (UVP) threshold level (see the *Electrical Characteristics* section of this data sheet). Although not specifically required, it is a good practice to hold $\overline{\text{RESET}}$ low during power down, thus preventing audible artifacts including pops and clicks

When the TAS5186A is being used with TI PWM modulators such as the TAS5086, no special attention to the state of $\overline{\text{RESET}}$ is required, provided that the chipset is configured as recommended.

Error Reporting

The $\overline{\text{SD}}$ and $\overline{\text{OTW}}$ pins are both active-low, open-drain outputs. Their function is for protection-mode signaling to a PWM controller or other system-control device.

Any fault resulting in device shutdown is signaled by the \overline{SD} pin going low. Likewise, \overline{OTW} goes low when the device junction temperature exceeds 125°C (see the following table).

\overline{SD}	\overline{OTW}	DESCRIPTION
0	0	Overtemperature (OTE) or overload (OLP) or undervoltage (UVP)
0	1	Overload (OLP) or undervoltage (UVP)
1	0	Overtemperature warning. Junction temperature higher than 125°C, typical
1	1	Normal operation. Junction temperature lower than 125°C, typical

It should be noted that asserting \overline{RESET} low forces the \overline{SD} and \overline{OTW} signals high independently of faults being present. It is recommended to monitor the \overline{OTW} signal using the system microcontroller and to respond to an overtemperature warning signal by, e.g., turning down the volume to prevent further heating of the device that would result in device shutdown (OTE). To reduce external component count, an internal pullup resistor to 3.3 V is provided on both the \overline{SD} and \overline{OTW} outputs. Level compliance for 5-V logic can be obtained by adding external pullup resistors to 5 V (see the *Electrical Characteristics* section of this data sheet for further specifications).

Device Protection System

The TAS5186A contains advanced protection circuitry carefully designed to facilitate system integration and ease of use, as well as safeguarding the device from permanent failure due to a wide range of fault conditions such as short circuit, overload, and undervoltage. The TAS5186A responds to a fault by immediately setting the power stage in a high-impedance state (Hi-Z) and asserting the \overline{SD} pin low. In situations other than overload, the device automatically recovers when the fault condition has been removed, e.g., the supply voltage has increased or the temperature has dropped. For highest possible reliability, recovering from an overload fault requires external reset of the device no sooner than 1 second after the shutdown (see the *Device Reset* section of this data sheet).

OVERCURRENT (OC) PROTECTION WITH CURRENT LIMITING AND OVERLOAD DETECTION

The device has independent, fast-reacting current detectors with programmable trip threshold (OC threshold) on all high-side and low-side power-stage FETs. See the following table for OC-adjust resistor values. The detector outputs are closely monitored by

two protection systems. The first protection system controls the power stage in order to prevent the output current from further increasing. i.e., it performs a current-limiting function rather than prematurely shutting down during combinations of high-level music transients and extreme speaker load-impedance drops. If the high-current situation persists, i.e., the power stage is being overloaded, a second protection system triggers a latching shutdown, resulting in the power stage being set in the high-impedance (Hi-Z) state.

For added flexibility, the OC threshold is programmable within a limited range using a single external resistor connected between the OC_ADJ pin and AGND.

OC-Adjust Resistor Values (k Ω)	Maximum Peak Current Before OC Occurs (A)
18	4.5 (sat.), 8 (sub.)

It should be noted that a properly functioning overcurrent detector assumes the presence of a properly designed demodulation filter at the power-stage output. Short-circuit protection is not provided directly at the output pins of the power stage but only on the speaker terminals (after the demodulation filter). It is required to follow certain guidelines when selecting the OC threshold and an appropriate demodulation inductor.

- For the lowest-cost bill of materials in terms of component selection, the OC threshold current should be limited, considering the power output requirement and minimum load impedance. Higher-impedance loads require a lower OC threshold.
- The demodulation filter inductor must retain at least 5 μ H of inductance at twice the OC threshold setting.

Most inductors have decreasing inductance with increasing temperature and increasing current (saturation). To some degree, an increase in temperature naturally occurs when operating at high output currents, due to inductor core losses and the dc resistance of the inductor copper winding. A thorough analysis of inductor saturation and thermal properties is strongly recommended.

Setting the OC threshold too low might cause issues such as lack of output power and/or unexpected shutdowns due to sensitive overload detection.

In general, it is recommended to follow closely the external component selection and PCB layout as given in the application section.

Overtemperature Protection

The TAS5186A has a two-level temperature-protection system that asserts an active-low warning signal (\overline{OTW}) when the device junction temperature exceeds 125°C (typical), and if the device junction temperature exceeds 155°C (typical), the device is put into thermal shutdown, resulting in all half-bridge outputs being set in the high-impedance state (Hi-Z) and \overline{SD} being asserted low.

UNDERVOLTAGE PROTECTION (UVP) AND POWER-ON RESET (POR)

The UVP and POR circuits of the TAS5186A fully protect the device in any power-up/down and brownout situation. While powering up, the POR circuit resets the overload circuit (OLP) and ensures that all circuits are fully operational when the GVDD_X and VDD supply voltages reach 10 V (typical). Although GVDD_X and VDD are independently monitored, a supply voltage drop below the UVP threshold on any VDD or GVDD_X pin results in all half-bridge outputs immediately being set in the high-impedance (Hi-Z) state and \overline{SD} being asserted low. The device automatically resumes operation when all supply voltages have increased above the UVP threshold.

DEVICE RESET

When \overline{RESET} is asserted low, the output FETs in all half-bridges are forced into a high-impedance (Hi-Z) state.

Asserting the \overline{RESET} input low removes any fault information to be signaled on the \overline{SD} output, i.e., \overline{SD} is forced high.

A rising-edge transition on the \overline{RESET} input allows the device to resume operation after an overload fault.

ACTIVE-BIAS CONTROL (ABC)

Audible pop noises are often associated with single-rail, single-ended power stages at power-up or at the start of switching. This commonly known problem has been virtually eliminated by incorporating a proprietary active-bias control circuitry as part of the TAS5186A feature set. By the use of only a few passive external components (typically resistors), the ABC can pre-charge the dc-blocking

element in the audio path, i.e., split-cap capacitors or series capacitor, to the desired potential before switching is started on the PWM outputs. (For recommended configuration, see the typical application schematic included in this data sheet).

The start-up sequence can be controlled through sequencing the M3 and \overline{RESET} pins according to Table 2 and Table 3.

Table 2. 5.1 Mode—All Output Channels Active

M3	\overline{RESET}	OUT_BIAS	OUT_A, _B, _C	OUT_D, _E, _F	COMMENT
0	0	Hi-Z	Hi-Z	Hi-Z	All outputs disabled, nothing is switching.
1	0	Active	Hi-Z	Hi-Z	OUT_BIAS enabled, all other outputs disabled
1	1	Hi-Z	Active	Active	OUT_BIAS disabled, all other outputs switching

Table 3. 2.1 Mode—Only Output Channels A, B, and C Active

M3	\overline{RESET}	OUT_BIAS	OUT_A, _B, _C	OUT_D, _E, _F	COMMENT
0	0	Hi-Z	Hi-Z	Hi-Z	All outputs disabled, nothing is switching.
1	0	Active	Hi-Z	Hi-Z	OUT_BIAS enabled, all other outputs disabled
0	1	Hi-Z	Active	Hi-Z	OUT_BIAS disabled, all other outputs switching

When the TAS5186A is used with the TAS5086 PWM modulator, no special attention to start-up sequencing is required, provided that the chipset is configured as recommended.

POWER OUTPUT STAGE (SE)

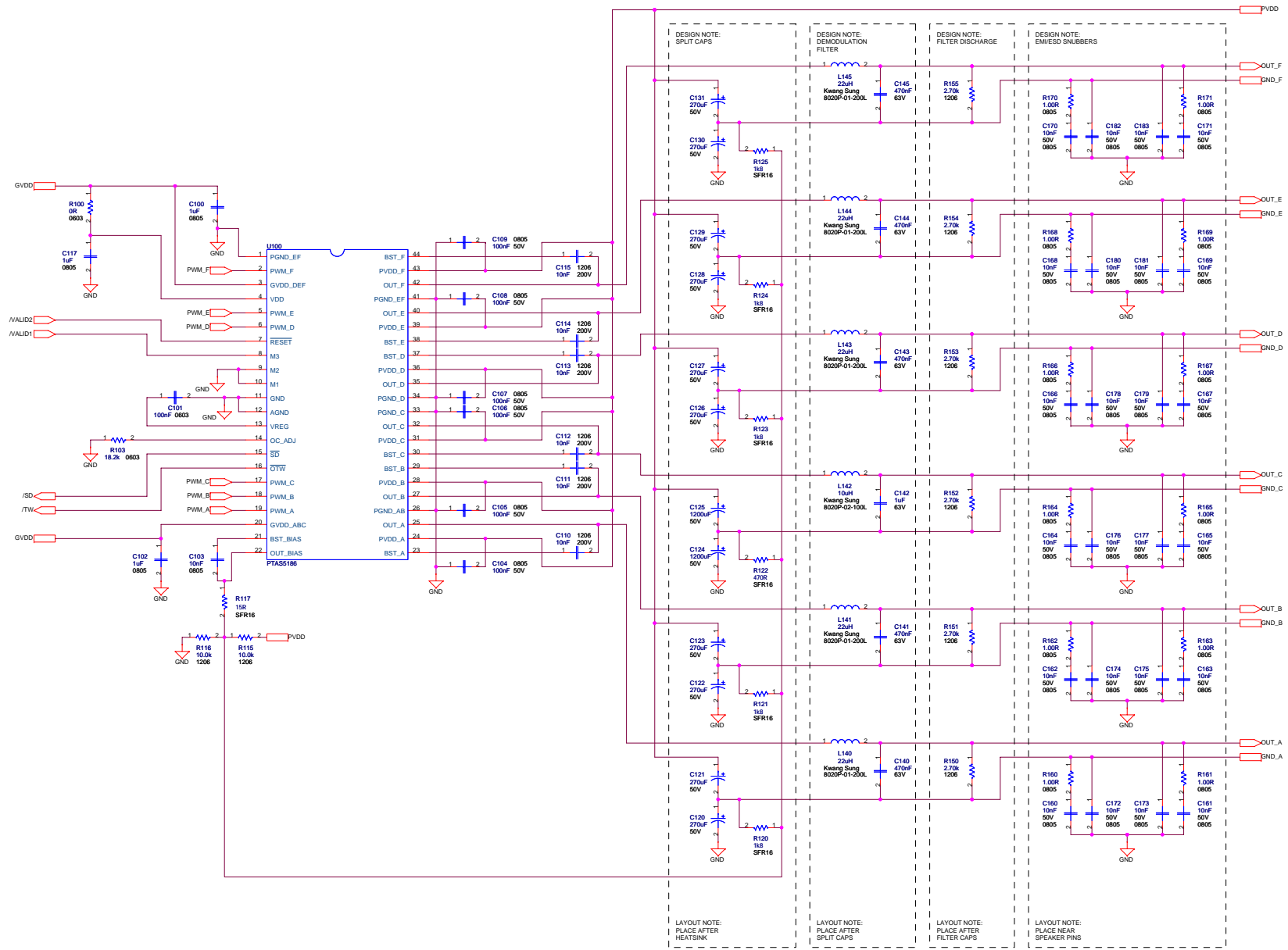

Parts List No. 2	
DIGITAL AUDIO & VIDEO DIVISION	
ALL RIGHTS RESERVED - PATENTS PENDING	
TEXAS INSTRUMENTS INCORPORATED	
Project: TASS008-6188VE1M	Rev: 2.10
Page Title: Power Stage	Size: A2
File Name: A799-SCH-001(2.10).DSN	Engineer: Jonas Svendsen
Date: Monday, September 12, 2005	Page: 3 of 6

Patents pending in circuitry design and layout (WO99/59241 & WO99/59242). This circuitry may only be used together with the integrated circuit TASS186 from Texas Instruments Incorporated.

PACKAGING INFORMATION

Orderable Device	Status (1)	Package Type	Package Drawing	Pins	Package Qty	Eco Plan (2)	Lead finish/ Ball material (6)	MSL Peak Temp (3)	Op Temp (°C)	Device Marking (4/5)	Samples
TAS5186ADDV	ACTIVE	HTSSOP	DDV	44	35	RoHS & Green	NIPDAU	Level-3-260C-168 HR	0 to 70	5186A	Samples
TAS5186ADDVR	ACTIVE	HTSSOP	DDV	44	2000	RoHS & Green	NIPDAU	Level-3-260C-168 HR	0 to 70	5186A	Samples

(1) The marketing status values are defined as follows:

ACTIVE: Product device recommended for new designs.

LIFEBUY: TI has announced that the device will be discontinued, and a lifetime-buy period is in effect.

NRND: Not recommended for new designs. Device is in production to support existing customers, but TI does not recommend using this part in a new design.

PREVIEW: Device has been announced but is not in production. Samples may or may not be available.

OBSOLETE: TI has discontinued the production of the device.

(2) **RoHS:** TI defines "RoHS" to mean semiconductor products that are compliant with the current EU RoHS requirements for all 10 RoHS substances, including the requirement that RoHS substance do not exceed 0.1% by weight in homogeneous materials. Where designed to be soldered at high temperatures, "RoHS" products are suitable for use in specified lead-free processes. TI may reference these types of products as "Pb-Free".

RoHS Exempt: TI defines "RoHS Exempt" to mean products that contain lead but are compliant with EU RoHS pursuant to a specific EU RoHS exemption.

Green: TI defines "Green" to mean the content of Chlorine (Cl) and Bromine (Br) based flame retardants meet JS709B low halogen requirements of <=1000ppm threshold. Antimony trioxide based flame retardants must also meet the <=1000ppm threshold requirement.

(3) MSL, Peak Temp. - The Moisture Sensitivity Level rating according to the JEDEC industry standard classifications, and peak solder temperature.

(4) There may be additional marking, which relates to the logo, the lot trace code information, or the environmental category on the device.

(5) Multiple Device Markings will be inside parentheses. Only one Device Marking contained in parentheses and separated by a "~" will appear on a device. If a line is indented then it is a continuation of the previous line and the two combined represent the entire Device Marking for that device.

(6) Lead finish/Ball material - Orderable Devices may have multiple material finish options. Finish options are separated by a vertical ruled line. Lead finish/Ball material values may wrap to two lines if the finish value exceeds the maximum column width.

Important Information and Disclaimer:The information provided on this page represents TI's knowledge and belief as of the date that it is provided. TI bases its knowledge and belief on information provided by third parties, and makes no representation or warranty as to the accuracy of such information. Efforts are underway to better integrate information from third parties. TI has taken and continues to take reasonable steps to provide representative and accurate information but may not have conducted destructive testing or chemical analysis on incoming materials and chemicals. TI and TI suppliers consider certain information to be proprietary, and thus CAS numbers and other limited information may not be available for release.

In no event shall TI's liability arising out of such information exceed the total purchase price of the TI part(s) at issue in this document sold by TI to Customer on an annual basis.

TAPE AND REEL INFORMATION



QUADRANT ASSIGNMENTS FOR PIN 1 ORIENTATION IN TAPE



*All dimensions are nominal

Device	Package Type	Package Drawing	Pins	SPQ	Reel Diameter (mm)	Reel Width W1 (mm)	A0 (mm)	B0 (mm)	K0 (mm)	P1 (mm)	W (mm)	Pin1 Quadrant
TAS5186ADDVR	HTSSOP	DDV	44	2000	330.0	24.4	8.6	15.6	1.8	12.0	24.0	Q1

TAPE AND REEL BOX DIMENSIONS



*All dimensions are nominal

Device	Package Type	Package Drawing	Pins	SPQ	Length (mm)	Width (mm)	Height (mm)
TAS5186ADDVR	HTSSOP	DDV	44	2000	350.0	350.0	43.0

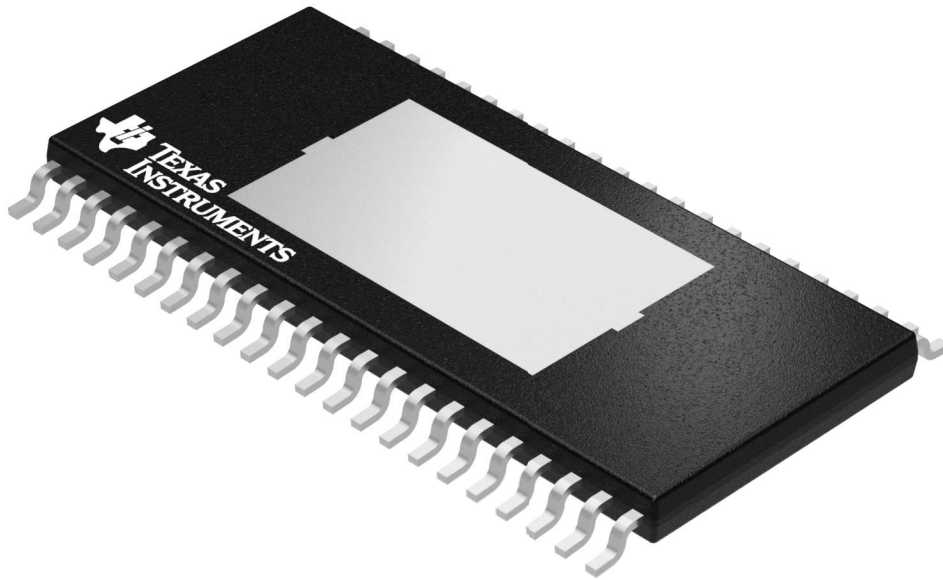

Images above are just a representation of the package family, actual package may vary.
Refer to the product data sheet for package details.

MECHANICAL DATA

DDV (R-PDSO-G44) PowerPAD™ PLASTIC SMALL OUTLINE PACKAGE (DIE DOWN)

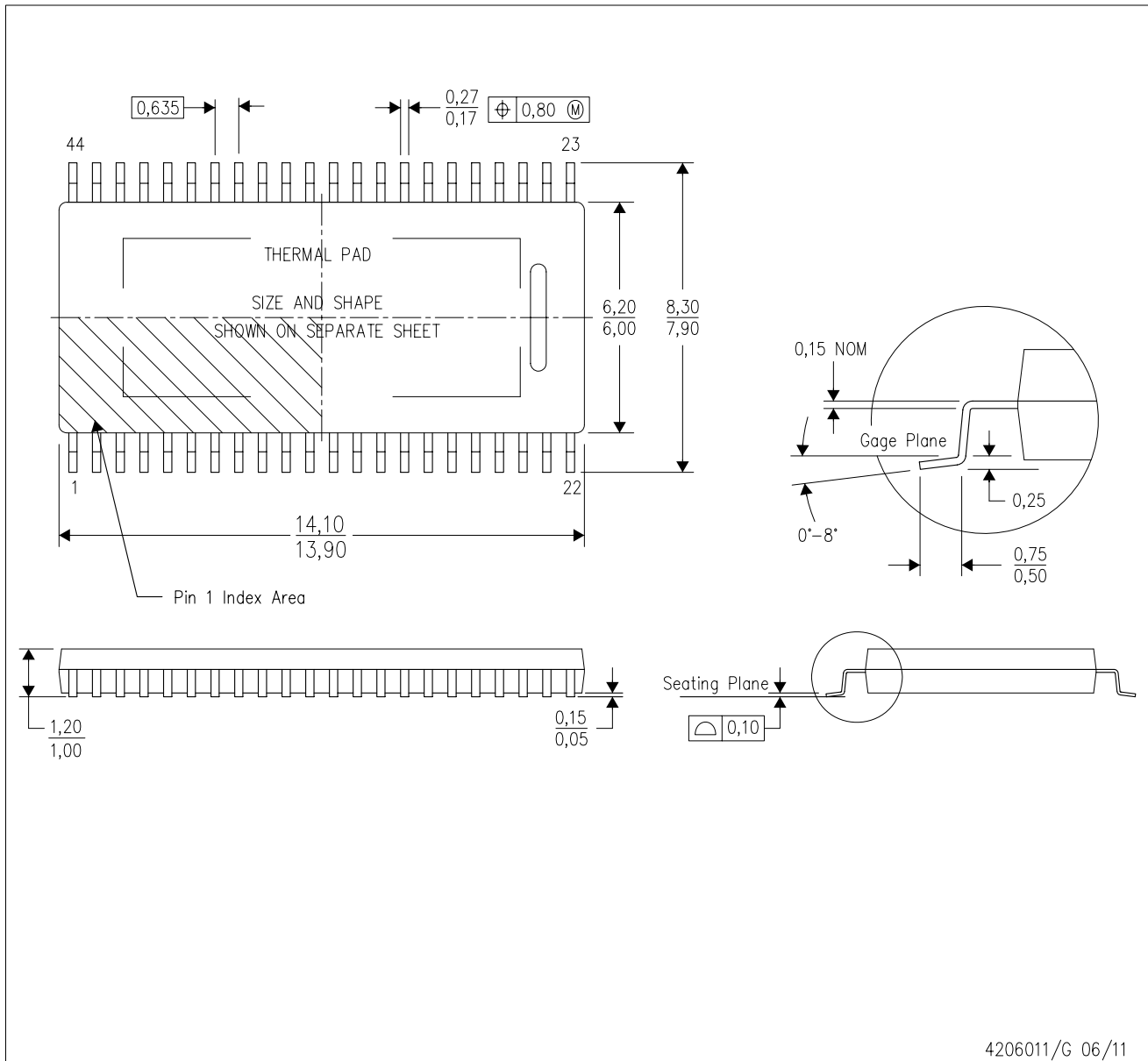

4206011/G 06/11

- NOTES:
- All linear dimensions are in millimeters. Dimensioning and tolerancing per ASME Y14.5M-1994.
 - This drawing is subject to change without notice.
 - Body dimensions do not include mold flash or protrusion not to exceed 0,15.
 - This package is designed to be attached directly to an external heatsink. Refer to Technical Brief, PowerPAD Thermally Enhanced Package, Texas Instruments Literature No. SLMA002 for information regarding recommended board layout. This document is available at www.ti.com <<http://www.ti.com>>. See the product data sheet for details regarding the exposed thermal pad dimensions.

PowerPAD is a trademark of Texas Instruments.

THERMAL PAD MECHANICAL DATA

DDV (R-PDSO-G44)

PowerPAD™ SMALL OUTLINE PACKAGE

THERMAL INFORMATION

This PowerPAD™ package incorporates an exposed thermal pad that is designed to be attached directly to an external heatsink. This design optimizes the heat transfer from the integrated circuit (IC).

For additional information on the PowerPAD package and how to take advantage of its heat dissipating abilities, refer to Technical Brief, PowerPAD Thermally Enhanced Package, Texas Instruments Literature No. SLMA002 and Application Brief, PowerPAD Made Easy, Texas Instruments Literature No. SLMA004. Both documents are available at www.ti.com.

The exposed thermal pad dimensions for this package are shown in the following illustration.

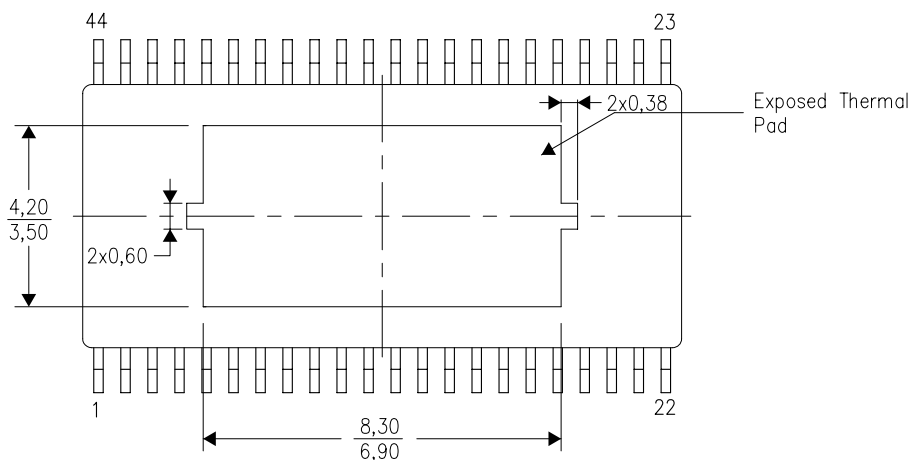

Top View

Exposed Thermal Pad Dimensions

4206975-2/D 07/11

NOTE: All linear dimensions are in millimeters

PowerPAD is a trademark of Texas Instruments

IMPORTANT NOTICE AND DISCLAIMER

TI PROVIDES TECHNICAL AND RELIABILITY DATA (INCLUDING DATASHEETS), DESIGN RESOURCES (INCLUDING REFERENCE DESIGNS), APPLICATION OR OTHER DESIGN ADVICE, WEB TOOLS, SAFETY INFORMATION, AND OTHER RESOURCES "AS IS" AND WITH ALL FAULTS, AND DISCLAIMS ALL WARRANTIES, EXPRESS AND IMPLIED, INCLUDING WITHOUT LIMITATION ANY IMPLIED WARRANTIES OF MERCHANTABILITY, FITNESS FOR A PARTICULAR PURPOSE OR NON-INFRINGEMENT OF THIRD PARTY INTELLECTUAL PROPERTY RIGHTS.

These resources are intended for skilled developers designing with TI products. You are solely responsible for (1) selecting the appropriate TI products for your application, (2) designing, validating and testing your application, and (3) ensuring your application meets applicable standards, and any other safety, security, or other requirements. These resources are subject to change without notice. TI grants you permission to use these resources only for development of an application that uses the TI products described in the resource. Other reproduction and display of these resources is prohibited. No license is granted to any other TI intellectual property right or to any third party intellectual property right. TI disclaims responsibility for, and you will fully indemnify TI and its representatives against, any claims, damages, costs, losses, and liabilities arising out of your use of these resources.

TI's products are provided subject to TI's Terms of Sale (www.ti.com/legal/termsofsale.html) or other applicable terms available either on ti.com or provided in conjunction with such TI products. TI's provision of these resources does not expand or otherwise alter TI's applicable warranties or warranty disclaimers for TI products.

Mailing Address: Texas Instruments, Post Office Box 655303, Dallas, Texas 75265
Copyright © 2020, Texas Instruments Incorporated