

Description

The AZ1117 is a series of low dropout three-terminal regulators with a dropout of 1.15V at 1A output current.

The AZ1117 series provides current limiting and thermal shutdown. Its circuit includes a trimmed bandgap reference to assure output voltage accuracy to be within 1% for 1.5V, 1.8V, 2.5V, 2.85V, 3.3V, 5.0V and adjustable versions or 2% for 1.2V version. Current limit is trimmed to ensure specified output current and controlled short-circuit current. On-chip thermal shutdown provides protection against any combination of overload and ambient temperature that would create excessive junction temperature.

The AZ1117 has an adjustable version, which can provide the output voltage from 1.25V to 12V with only 2 external resistors.

The AZ1117 series is available in the industry standard SOT223, SOT89, TO220-3, TO252-2 (3), TO252-2 (4), TO252-2 (5) and TO263 power packages.

Features

- Low Dropout Voltage: 1.15V at 1A Output Current
- Trimmed Current Limit
- On-chip Thermal Shutdown
- Three-terminal Adjustable or Fixed 1.2V, 1.5V, 1.8V, 2.5V, 2.85V, 3.3V, 5.0V
- Operation Junction Temperature: -40 to +125°C
- Lead-Free Packages: SOT223, SOT89, TO220-3, TO252-2 (3), TO252-2 (4), TO252-2 (5), TO263
- **Totally Lead-Free; RoHS Compliant (Notes 1 & 2)**

Applications

- PC Motherboard
- LCD Monitor
- Graphic Card
- DVD-video Player
- NIC/Switch
- Telecom Equipment
- ADSL Modem
- Printer and other Peripheral Equipment

- Notes:
1. No purposely added lead. Fully EU Directive 2002/95/EC (RoHS) & 2011/65/EU (RoHS 2) compliant.
 2. See http://www.diodes.com/quality/lead_free.html for more information about Diodes Incorporated's definitions of Halogen- and Antimony-free, "Green" and Lead-free.

Pin Assignments

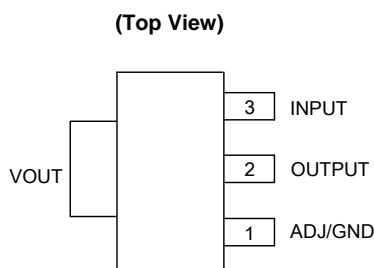

(SOT223/ H Package)

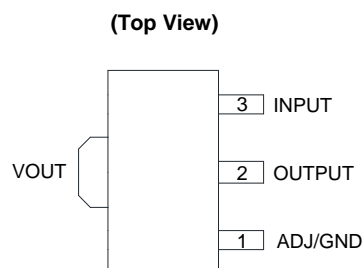

(SOT89 Option 1/ R Package)

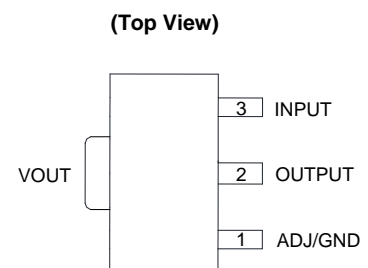

(SOT89 Option 2/ R Package)

Pin Assignments (Cont.)

(Top View)

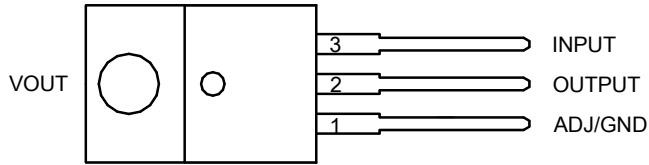

(TO220-3 Option 1/ T Package)

(Top View)

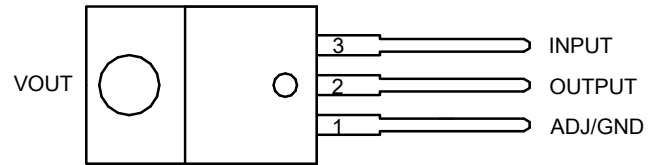

(TO220-3 Option 2/ T Package)

(Top View)

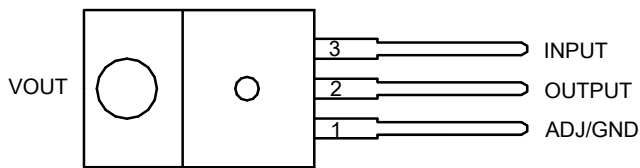

(TO220-3 Option 3/ T Package)

(Top View)

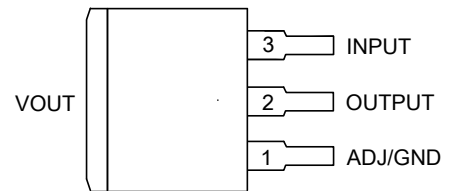

(TO263/ S Package)

(Top View)

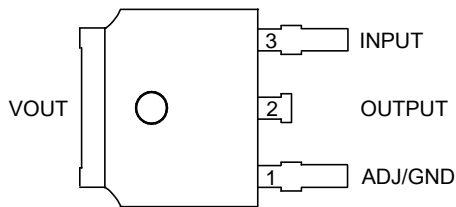

(TO252-2 (3) Option 1/ D Package)

(Top View)

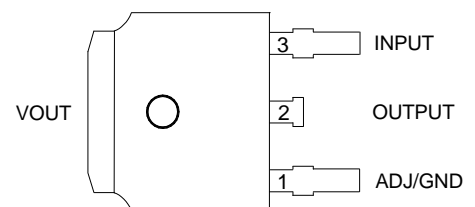

(TO252-2 (3) Option 2/ D Package)

(Top View)

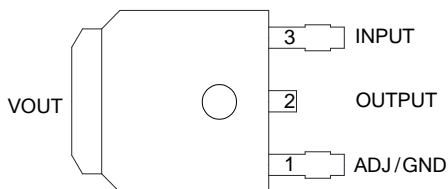

(TO252-2 (4)/ D Package)

(Top View)

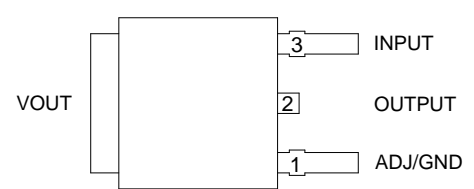

(TO252-2 (5)/ D Package)

Typical Applications Circuit

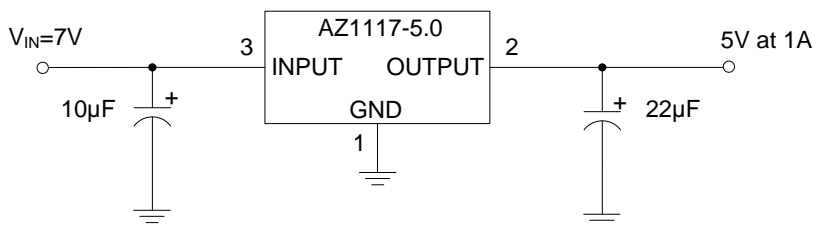
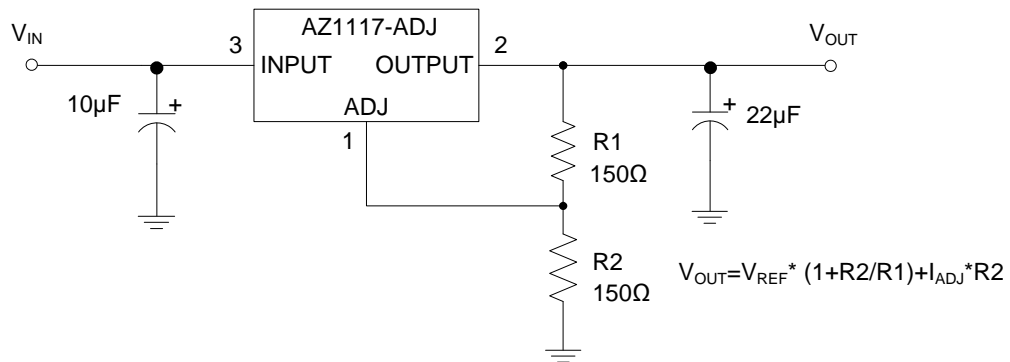

Functional Block Diagram

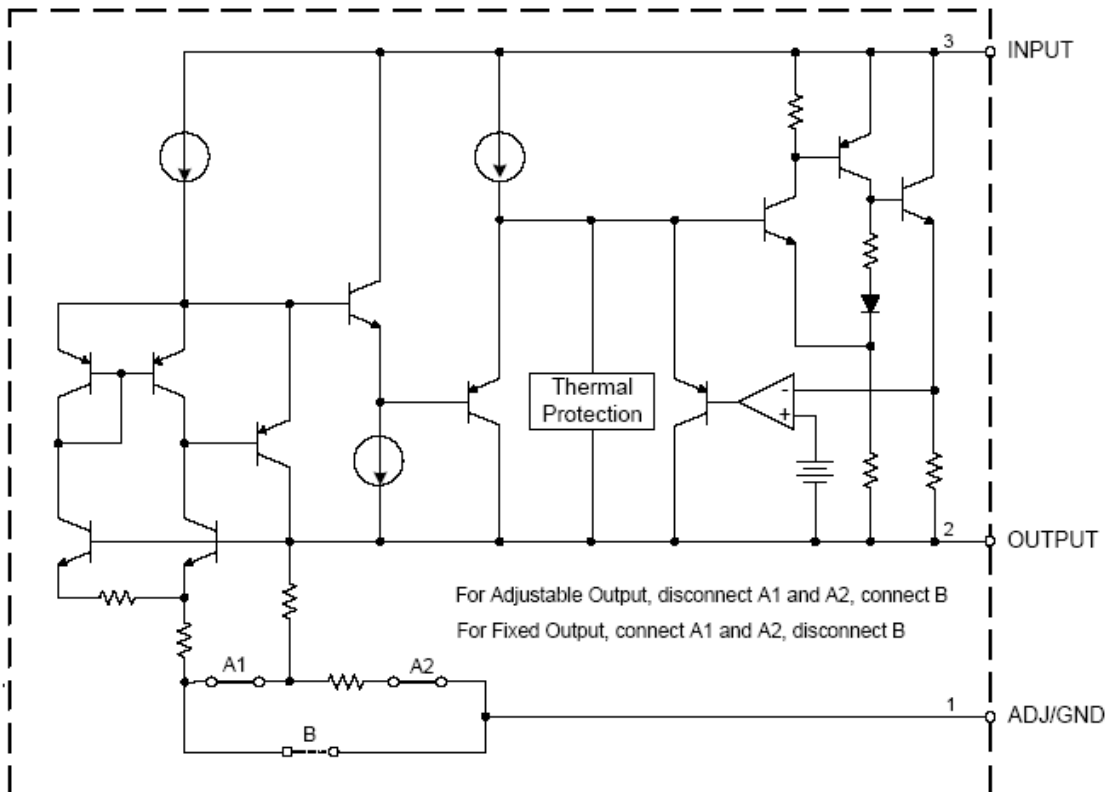

Absolute Maximum Ratings (Note 3)

Parameter	Symbol	Value		Unit
Input Voltage	V_{IN}	20		V
Operating Junction Temperature	T_J	+150		°C
Storage Temperature	T_S	-65 to +150		°C
Lead Temperature (Soldering, 10sec)	T_{LEAD}	+260		°C
Thermal Resistance (No Heatsink, Note 4)	θ_{JA}	SOT223	120	°C/W
		SOT89	165	
		TO220-3	60	
		TO252-2 (3) TO252-2 (4) TO252-2 (5)	100	
		TO263	60	
ESD (Human Body Model)	ESD	2000		V
ESD (Machine Model)	ESD	250		V

- Notes:
- Stresses greater than those listed under "Absolute Maximum Ratings" may cause permanent damage to the device. These are stress ratings only, and functional operation of the device at these or any other conditions beyond those indicated under "Recommended Operating Conditions" is not implied. Exposure to "Absolute Maximum Ratings" for extended periods may affect device reliability.
 - Absolute maximum ratings indicate limits beyond which damage to the component may occur. Electrical specifications do not apply when operating the device outside of its operating ratings. The maximum allowable power dissipation is a function of the maximum junction temperature, $T_{J(max)}$, the junction-to-ambient thermal resistance, θ_{JA} , and the ambient temperature, T_A . The maximum allowable power dissipation at any ambient temperature is calculated using: $P_{D(max)} = (T_{J(max)} - T_A) / \theta_{JA}$. Exceeding the maximum allowable power dissipation will result in excessive die temperature, and the regulator will go into thermal shutdown.

Recommended Operating Conditions

Parameter	Symbol	Min	Max	Unit
Input Voltage	V_{IN}	-	15	V
Operating Junction Temperature Range	T_J	-40	+125	°C

Electrical Characteristics

AZ1117-ADJ Electrical Characteristics (Operating Conditions: $V_{IN} \leq 10V$, $T_J = +25^\circ C$, unless otherwise specified.)

Parameter	Symbol	Conditions	Min	Typ	Max	Unit
Reference Voltage	V_{REF}	$I_{OUT} = 10mA$, $V_{IN}-V_{OUT} = 2V$ $10mA \leq I_{OUT} \leq 1A$, $1.4V \leq V_{IN}-V_{OUT} \leq 8V$, $P \leq$ Maximum Power Dissipation	1.238 1.225	1.250 1.250	1.262 1.270	V
Line Regulation	ΔV_{OUT}	$I_{OUT}=10mA$, $1.5V \leq V_{IN}-V_{OUT} \leq 10V$	–	0.035	0.2	%
Load Regulation	ΔV_{OUT}	$V_{IN}-V_{OUT} = 2V$, $10mA \leq I_{OUT} \leq 1A$	–	0.2	0.4	%
Dropout Voltage	V_{DROP}	$\Delta V_{REF} = 1\%$, $I_{OUT} = 0.1A$	–	1.00	1.1	V
		$\Delta V_{REF} = 1\%$, $I_{OUT} = 0.5A$	–	1.08	1.18	V
		$\Delta V_{REF} = 1\%$, $I_{OUT} = 1.0A$	–	1.15	1.25	V
Current Limit	I_{LIMIT}	$V_{IN}-V_{OUT} = 2V$	1.25	1.35	–	A
Adjust Pin Current	I_{ADJ}	–	–	60	120	μA
Adjust Pin Current Change	ΔI_{ADJ}	$1.4V \leq V_{IN}-V_{OUT} \leq 10V$, $10mA \leq I_{OUT} \leq 1A$	–	0.2	5	μA
Minimum Load Current (ADJ)	$I_{LOAD(MIN)}$	$1.5V \leq V_{IN}-V_{OUT} \leq 10V$ (ADJ only)	–	1.7	5	mA
Quiescent Current	I_Q	$V_{IN} = V_{OUT} + 1.25V$	–	5	10	mA
Ripple Rejection	PSRR	$f = 120Hz$, $C_{OUT} = 22\mu F$ Tantalum, $V_{IN}-V_{OUT} = 3V$, $I_{OUT} = 1A$	60	75	–	dB
Temperature Stability	–	–	–	0.5	–	%
Long-term Stability	–	$T_A = +125^\circ C$, 1000hrs	–	0.3	–	%
RMS Output Noise (% of V_{OUT})	–	$T_A = +25^\circ C$, $10Hz \leq f \leq 10kHz$	–	0.003	–	%
Thermal Shutdown	–	Junction Temperature	–	+150	–	$^\circ C$
Thermal Shutdown Hysteresis	–	–	–	+25	–	$^\circ C$
Thermal Resistance	θ_{JC}	SOT223	–	25	–	$^\circ C/W$
		SOT89	–	30	–	
		TO220-3	–	10	–	
		TO252-2 (3)/TO252-2 (4)/TO252-2 (5)	–	17	–	
		TO263	–	10	–	

Electrical Characteristics (Cont.)

AZ1117-1.2 Electrical Characteristics (Operating Conditions: $V_{IN} \leq 10V$, $T_J = +25^\circ C$, unless otherwise specified.)

Parameter	Symbol	Conditions	Min	Typ	Max	Unit
Output Voltage	V_{OUT}	$I_{OUT} = 10mA$, $V_{IN} = 3.2V$ $10mA \leq I_{OUT} \leq 1A$, $3.0V \leq V_{IN} \leq 10V$	1.176 1.152	1.2 1.2	1.224 1.248	V
Line Regulation	ΔV_{OUT}	$I_{OUT} = 10mA$, $1.5V \leq V_{IN} - V_{OUT} \leq 10V$	–	1	6	mV
Load Regulation	ΔV_{OUT}	$V_{IN} - V_{OUT} = 2V$, $10mA \leq I_{OUT} \leq 1A$	–	1	10	mV
Dropout Voltage	V_{DROP}	$\Delta V_{OUT} = 1\%$, $I_{OUT} = 0.1A$	–	1.00	1.1	V
		$\Delta V_{OUT} = 1\%$, $I_{OUT} = 0.5A$	–	1.08	1.18	V
		$\Delta V_{OUT} = 1\%$, $I_{OUT} = 1.0A$	–	1.15	1.25	V
Current Limit	I_{LIMIT}	$V_{IN} - V_{OUT} = 2V$	1.25	1.35	–	A
Quiescent Current	I_Q	$V_{IN} = V_{OUT} + 1.25V$	–	5	10	mA
Ripple Rejection	PSRR	$f = 120Hz$, $C_{OUT} = 22\mu F$ Tantalum, $V_{IN} - V_{OUT} = 3V$, $I_{OUT} = 1A$	60	75	–	dB
Temperature Stability	–	–	–	0.5	–	%
Long-term Stability	–	$T_A = +125^\circ C$, 1000hrs	–	0.3	–	%
RMS Output Noise (% of V_{OUT})	–	$T_A = +25^\circ C$, $10Hz \leq f \leq 10kHz$	–	0.003	–	%
Thermal Shutdown	–	Junction Temperature	–	+150	–	$^\circ C$
Thermal Shutdown Hysteresis	–	–	–	+25	–	$^\circ C$
Thermal Resistance	θ_{JC}	SOT223	–	25	–	$^\circ C/W$
		SOT89	–	30	–	
		TO220-3	–	10	–	
		TO252-2 (3)/TO252-2 (4)/TO252-2 (5)	–	17	–	
		TO263	–	10	–	

Electrical Characteristics (Cont.)

AZ1117-1.5 Electrical Characteristics (Operating Conditions: $V_{IN} \leq 10V$, $T_J = +25^\circ C$, unless otherwise specified.)

Parameter	Symbol	Conditions	Min	Typ	Max	Unit
Output Voltage	V_{OUT}	$I_{OUT} = 10mA$, $V_{IN} = 3.5V$ $10mA \leq I_{OUT} \leq 1A$, $3.0V \leq V_{IN} \leq 10V$	1.485 1.470	1.5 1.5	1.515 1.530	V
Line Regulation	ΔV_{OUT}	$I_{OUT} = 10mA$, $1.5V \leq V_{IN} - V_{OUT} \leq 10V$	–	1	6	mV
Load Regulation	ΔV_{OUT}	$V_{IN} - V_{OUT} = 2V$, $10mA \leq I_{OUT} \leq 1A$	–	1	10	mV
Dropout Voltage	V_{DROP}	$\Delta V_{OUT} = 1\%$, $I_{OUT} = 0.1A$	–	1.00	1.1	V
		$\Delta V_{OUT} = 1\%$, $I_{OUT} = 0.5A$	–	1.08	1.18	V
		$\Delta V_{OUT} = 1\%$, $I_{OUT} = 1.0A$	–	1.15	1.25	V
Current Limit	I_{LIMIT}	$V_{IN} - V_{OUT} = 2V$	1.25	1.35	–	A
Quiescent Current	I_Q	$V_{IN} = V_{OUT} + 1.25V$	–	5	10	mA
Ripple Rejection	PSRR	$f = 120Hz$, $C_{OUT} = 22\mu F$ Tantalum, $V_{IN} - V_{OUT} = 3V$, $I_{OUT} = 1A$	60	75	–	dB
Temperature Stability	–	–	–	0.5	–	%
Long-term Stability	–	$T_A = +125^\circ C$, 1000hrs	–	0.3	–	%
RMS Output Noise (% of V_{OUT})	–	$T_A = +25^\circ C$, $10Hz \leq f \leq 10kHz$	–	0.003	–	%
Thermal Shutdown	–	Junction Temperature	–	+150	–	$^\circ C$
Thermal Shutdown Hysteresis	–	–	–	+25	–	$^\circ C$
Thermal Resistance	θ_{JC}	SOT223	–	25	–	$^\circ C/W$
		SOT89	–	30	–	
		TO220-3	–	10	–	
		TO252-2 (3)/TO252-2 (4)/TO252-2 (5)	–	17	–	
		TO263	–	10	–	

Electrical Characteristics (Cont.)

AZ1117-1.8 Electrical Characteristics (Operating Conditions: $V_{IN} \leq 10V$, $T_J = +25^\circ C$, unless otherwise specified.)

Parameter	Symbol	Conditions	Min	Typ	Max	Unit
Output Voltage	V_{OUT}	$I_{OUT} = 10mA$, $V_{IN} = 3.8V$ $10mA \leq I_{OUT} \leq 1A$, $3.2V \leq V_{IN} \leq 10V$	1.782 1.746	1.8 1.8	1.818 1.854	V
Line Regulation	ΔV_{OUT}	$I_{OUT} = 10mA$, $1.5V \leq V_{IN} - V_{OUT} \leq 10V$	–	1	6	mV
Load Regulation	ΔV_{OUT}	$V_{IN} - V_{OUT} = 2V$, $10mA \leq I_{OUT} \leq 1A$	–	1	10	mV
Dropout Voltage	V_{DROP}	$\Delta V_{OUT} = 1\%$, $I_{OUT} = 0.1A$	–	1.00	1.1	V
		$\Delta V_{OUT} = 1\%$, $I_{OUT} = 0.5A$	–	1.08	1.18	V
		$\Delta V_{OUT} = 1\%$, $I_{OUT} = 1.0A$	–	1.15	1.25	V
Current Limit	I_{LIMIT}	$V_{IN} - V_{OUT} = 2V$	1.25	1.35	–	A
Quiescent Current	I_Q	$V_{IN} = V_{OUT} + 1.25V$	–	5	10	mA
Ripple Rejection	PSRR	$f = 120Hz$, $C_{OUT} = 22\mu F$ Tantalum, $V_{IN} - V_{OUT} = 3V$, $I_{OUT} = 1A$	60	75	–	dB
Temperature Stability	–	–	–	0.5	–	%
Long-term Stability	–	$T_A = +125^\circ C$, 1000hrs	–	0.3	–	%
RMS Output Noise (% of V_{OUT})	–	$T_A = +25^\circ C$, $10Hz \leq f \leq 10kHz$	–	0.003	–	%
Thermal Shutdown	–	Junction Temperature	–	+150	–	$^\circ C$
Thermal Shutdown Hysteresis	–	–	–	+25	–	$^\circ C$
Thermal Resistance	θ_{JC}	SOT223	–	25	–	$^\circ C/W$
		SOT89	–	30	–	
		TO220-3	–	10	–	
		TO252-2 (3)/TO252-2 (4)/TO252-2 (5)	–	17	–	
		TO263	–	10	–	

Electrical Characteristics (Cont.)

AZ1117-2.5 Electrical Characteristics (Operating Conditions: $V_{IN} \leq 10V$, $T_J = +25^\circ C$, unless otherwise specified.)

Parameter	Symbol	Conditions	Min	Typ	Max	Unit
Output Voltage	V_{OUT}	$I_{OUT} = 10mA$, $V_{IN} = 4.5V$ $10mA \leq I_{OUT} \leq 1A$, $3.9V \leq V_{IN} \leq 10V$	2.475 2.450	2.5 2.5	2.525 2.550	V
Line Regulation	ΔV_{OUT}	$I_{OUT} = 10mA$, $1.5V \leq V_{IN} - V_{OUT} \leq 10V$	–	1	6	mV
Load Regulation	ΔV_{OUT}	$V_{IN} - V_{OUT} = 2V$, $10mA \leq I_{OUT} \leq 1A$	–	1	10	mV
Dropout Voltage	V_{DROP}	$\Delta V_{OUT} = 1\%$, $I_{OUT} = 0.1A$	–	1.00	1.1	V
		$\Delta V_{OUT} = 1\%$, $I_{OUT} = 0.5A$	–	1.08	1.18	V
		$\Delta V_{OUT} = 1\%$, $I_{OUT} = 1.0A$	–	1.15	1.25	V
Current Limit	I_{LIMIT}	$V_{IN} - V_{OUT} = 2V$	1.25	1.35	–	A
Quiescent Current	I_Q	$V_{IN} = V_{OUT} + 1.25V$	–	5	10	mA
Ripple Rejection	PSRR	$f = 120Hz$, $C_{OUT} = 22\mu F$ Tantalum, $V_{IN} - V_{OUT} = 3V$, $I_{OUT} = 1A$	60	75	–	dB
Temperature Stability	–	–	–	0.5	–	%
Long-term Stability	–	$T_A = +125^\circ C$, 1000hrs	–	0.3	–	%
RMS Output Noise (% of V_{OUT})	–	$T_A = +25^\circ C$, $10Hz \leq f \leq 10kHz$	–	0.003	–	%
Thermal Shutdown	–	Junction Temperature	–	+150	–	$^\circ C$
Thermal Shutdown Hysteresis	–	–	–	+25	–	$^\circ C$
Thermal Resistance	θ_{JC}	SOT223	–	25	–	$^\circ C/W$
		SOT89	–	30	–	
		TO220-3	–	10	–	
		TO252-2 (3)/TO252-2 (4)/TO252-2 (5)	–	17	–	
		TO263	–	10	–	

Electrical Characteristics (Cont.)

AZ1117-2.85 Electrical Characteristics (Operating Conditions: $V_{IN} \leq 10V$, $T_J = +25^\circ C$, unless otherwise specified.)

Parameter	Symbol	Conditions	Min	Typ	Max	Unit
Output Voltage	V_{OUT}	$I_{OUT} = 10mA$, $V_{IN} = 4.85V$ $10mA \leq I_{OUT} \leq 1A$, $4.25V \leq V_{IN} \leq 10V$	2.822 2.793	2.85 2.85	2.878 2.907	V
Line Regulation	ΔV_{OUT}	$I_{OUT} = 10mA$, $1.5V \leq V_{IN} - V_{OUT} \leq 10V$	–	1	6	mV
Load Regulation	ΔV_{OUT}	$V_{IN} - V_{OUT} = 2V$, $10mA \leq I_{OUT} \leq 1A$	–	1	10	mV
Dropout Voltage	V_{DROP}	$\Delta V_{REF} = 1\%$, $I_{OUT} = 0.1A$	–	1.00	1.1	V
		$\Delta V_{REF} = 1\%$, $I_{OUT} = 0.5A$	–	1.08	1.18	V
		$\Delta V_{REF} = 1\%$, $I_{OUT} = 1.0A$	–	1.15	1.25	V
Current Limit	I_{LIMIT}	$V_{IN} - V_{OUT} = 2V$	1.25	1.35	–	A
Quiescent Current	I_Q	$V_{IN} = V_{OUT} + 1.25V$	–	5	10	mA
Ripple Rejection	PSRR	$f = 120Hz$, $C_{OUT} = 22\mu F$ Tantalum, $V_{IN} - V_{OUT} = 3V$, $I_{OUT} = 1A$	60	75	–	dB
Temperature Stability	–	–	–	0.5	–	%
Long-term Stability	–	$T_A = +125^\circ C$, 1000hrs	–	0.3	–	%
RMS Output Noise (% of V_{OUT})	–	$T_A = +25^\circ C$, $10Hz \leq f \leq 10kHz$	–	0.003	–	%
Thermal Shutdown	–	Junction Temperature	–	+150	–	$^\circ C$
Thermal Shutdown Hysteresis	–	–	–	+25	–	$^\circ C$
Thermal Resistance	θ_{JC}	SOT223	–	25	–	$^\circ C/W$
		SOT89	–	30	–	
		TO220-3	–	10	–	
		TO252-2 (3)/TO252-2 (4)/TO252-2 (5)	–	17	–	
		TO263	–	10	–	

Electrical Characteristics (Cont.)

AZ1117-3.3 Electrical Characteristics (Operating Conditions: $V_{IN} \leq 10V$, $T_J = +25^\circ C$, unless otherwise specified.)

Parameter	Symbol	Conditions	Min	Typ	Max	Unit
Output Voltage	V_{OUT}	$I_{OUT} = 10mA$, $V_{IN} = 5.0V$ $10mA \leq I_{OUT} \leq 1A$, $4.75V \leq V_{IN} \leq 10V$	3.267 3.235	3.3 3.3	3.333 3.365	V
Line Regulation	ΔV_{OUT}	$I_{OUT} = 10mA$, $1.5V \leq V_{IN} - V_{OUT} \leq 10V$	–	1	6	mV
Load Regulation	ΔV_{OUT}	$V_{IN} - V_{OUT} = 2V$, $10mA \leq I_{OUT} \leq 1A$	–	1	10	mV
Dropout Voltage	V_{DROP}	$\Delta V_{OUT} = 1\%$, $I_{OUT} = 0.1A$	–	1.00	1.1	V
		$\Delta V_{OUT} = 1\%$, $I_{OUT} = 0.5A$	–	1.08	1.18	V
		$\Delta V_{OUT} = 1\%$, $I_{OUT} = 1.0A$	–	1.15	1.25	V
Current Limit	I_{LIMIT}	$V_{IN} - V_{OUT} = 2V$	1.25	1.35	–	A
Quiescent Current	I_Q	$V_{IN} = V_{OUT} + 1.25V$	–	5	10	mA
Ripple Rejection	PSRR	$f = 120Hz$, $C_{OUT} = 22\mu F$ Tantalum, $V_{IN} - V_{OUT} = 3V$, $I_{OUT} = 1A$	60	75	–	dB
Temperature Stability	–	–	–	0.5	–	%
Long-term Stability	–	$T_A = +125^\circ C$, 1000hrs	–	0.3	–	%
RMS Output Noise (% of V_{OUT})	–	$T_A = +25^\circ C$, $10Hz \leq f \leq 10kHz$	–	0.003	–	%
Thermal Shutdown	–	Junction Temperature	–	+150	–	$^\circ C$
Thermal Shutdown Hysteresis	–	–	–	+25	–	$^\circ C$
Thermal Resistance	θ_{JC}	SOT223	–	25	–	$^\circ C/W$
		SOT89	–	30	–	
		TO220-3	–	10	–	
		TO252-2 (3)/TO252-2 (4)/TO252-2 (5)	–	17	–	
		TO263	–	10	–	

Electrical Characteristics (Cont.)

AZ1117-5.0 Electrical Characteristics (Operating Conditions: $V_{IN} \leq 10V$, $T_J = +25^\circ C$, unless otherwise specified.)

Parameter	Symbol	Conditions	Min	Typ	Max	Unit
Output Voltage	V_{OUT}	$I_{OUT} = 10mA$, $V_{IN} = 7.0V$ $10mA \leq I_{OUT} \leq 1A$, $6.5V \leq V_{IN} \leq 12V$	4.950 4.900	5.0 5.0	5.050 5.100	V
Line Regulation	ΔV_{OUT}	$I_{OUT} = 10mA$, $1.5V \leq V_{IN} - V_{OUT} \leq 10V$	–	1	10	mV
Load Regulation	ΔV_{OUT}	$V_{IN} - V_{OUT} = 2V$, $10mA \leq I_{OUT} \leq 1A$	–	1	15	mV
Dropout Voltage	V_{DROP}	$\Delta V_{OUT} = 1\%$, $I_{OUT} = 0.1A$	–	1.00	1.1	V
		$\Delta V_{OUT} = 1\%$, $I_{OUT} = 0.5A$	–	1.08	1.18	V
		$\Delta V_{OUT} = 1\%$, $I_{OUT} = 1.0A$	–	1.15	1.25	V
Current Limit	I_{LIMIT}	$V_{IN} - V_{OUT} = 2V$	1.25	1.35	–	A
Quiescent Current	I_Q	$V_{IN} = V_{OUT} + 1.25V$	–	5	10	mA
Ripple Rejection	PSRR	$f = 120Hz$, $C_{OUT} = 22\mu F$ Tantalum, $V_{IN} - V_{OUT} = 3V$, $I_{OUT} = 1A$	60	75	–	dB
Temperature Stability	–	–	–	0.5	–	%
Long-term Stability	–	$T_A = +125^\circ C$, 1000hrs	–	0.3	–	%
RMS Output Noise (% of V_{OUT})	–	$T_A = +25^\circ C$, $10Hz \leq f \leq 10kHz$	–	0.003	–	%
Thermal Shutdown	–	Junction Temperature	–	+150	–	$^\circ C$
Thermal Shutdown Hysteresis	–	–	–	+25	–	$^\circ C$
Thermal Resistance	θ_{JC}	SOT223	–	25	–	$^\circ C/W$
		SOT89	–	30	–	
		TO220-3	–	10	–	
		TO252-2 (3)/TO252-2 (4)/TO252-2 (5)	–	17	–	
		TO263	–	10	–	

Performance Characteristics

Dropout Voltage vs. Output Current

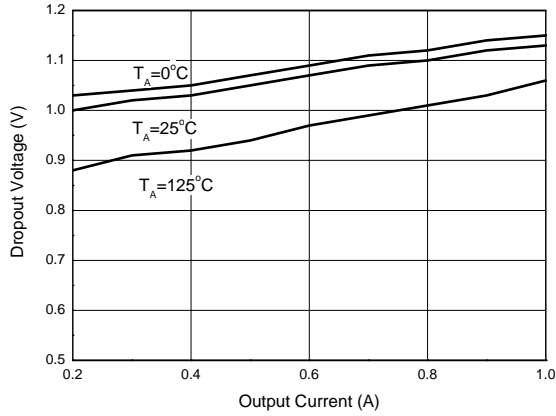

Dropout Voltage vs. Junction Temperature

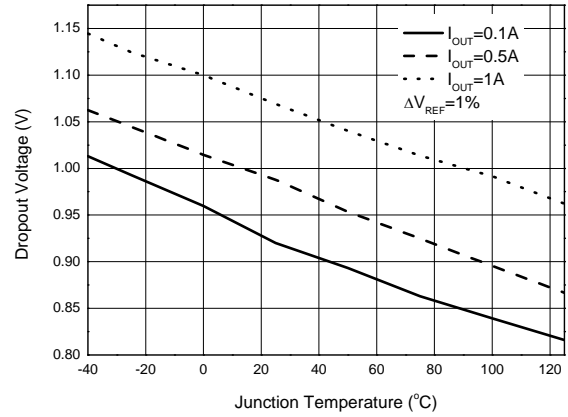

Load Regulation vs. Junction Temperature

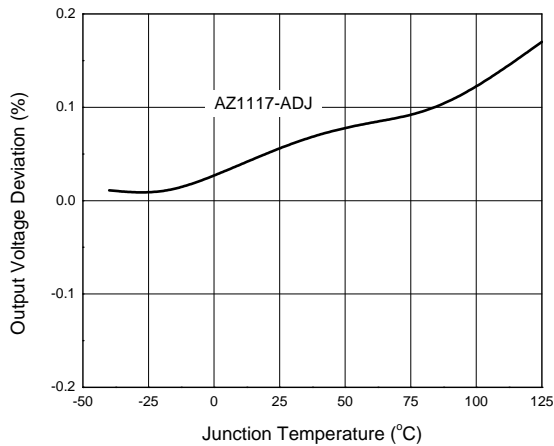

Reference Voltage vs. Junction Temperature

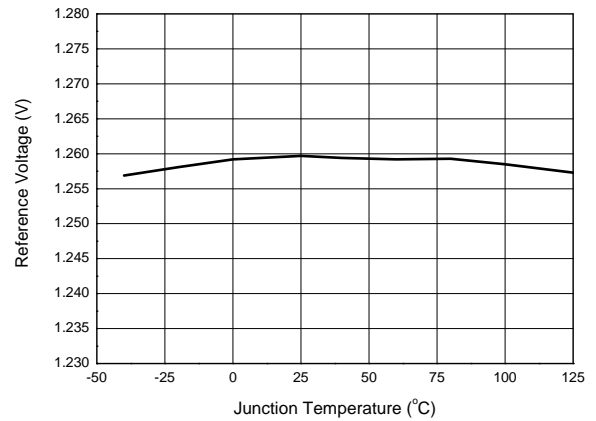

Output Voltage vs. Junction Temperature

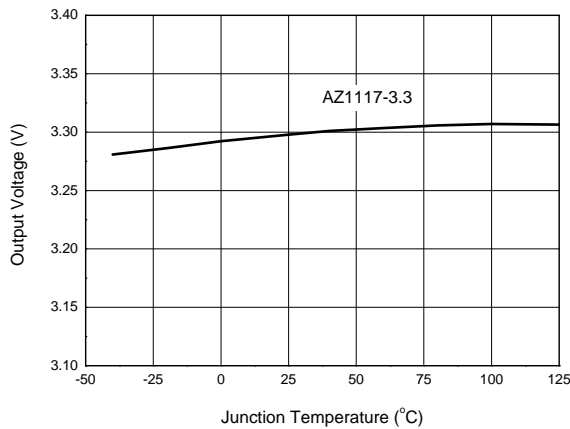

Minimum Load Current vs. Junction Temperature

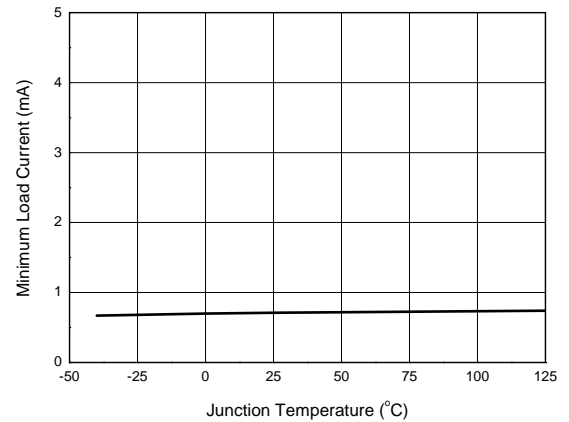

Performance Characteristics (Cont.)

Adjust Pin Current vs. Junction Temperature

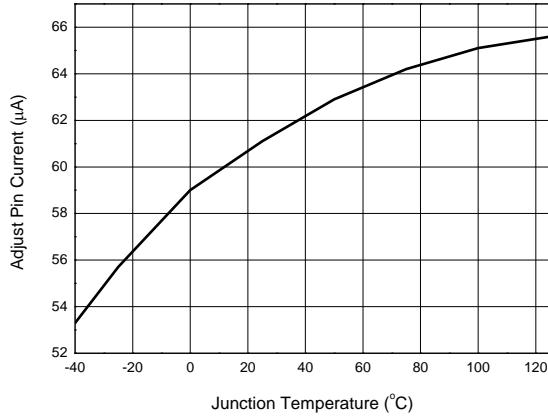

Short-circuit Current vs. Junction Temperature

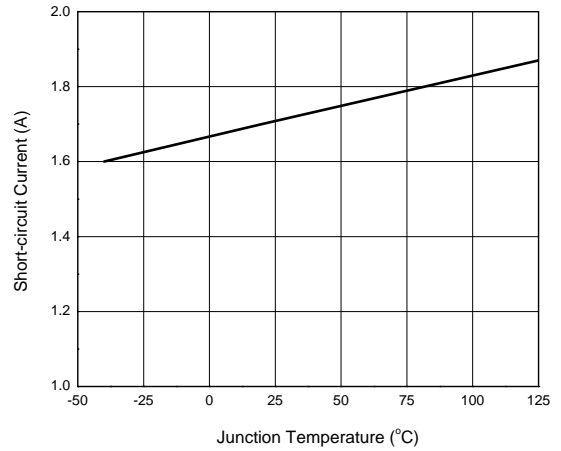

Maximum Power Dissipation

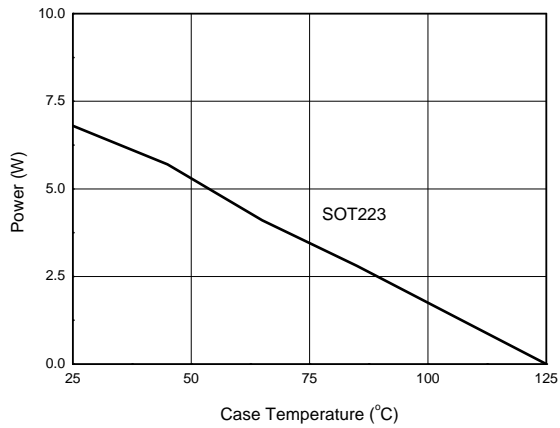

Ripple Rejection vs. Frequency

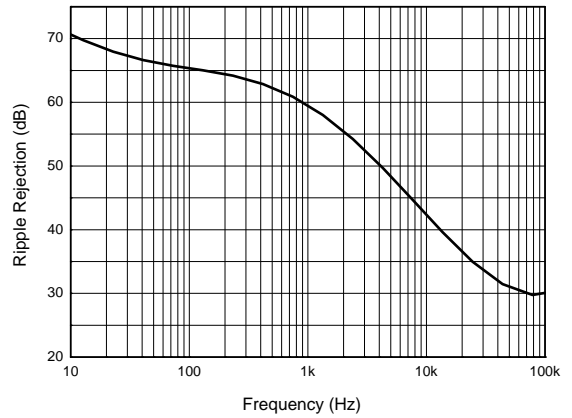

Line Transient Response
(Conditions: $V_{IN} = 4.8$ to $5.8V$, $V_{OUT} = 3.33V$, $I_{OUT} = 0.1A$, $C_{IN} = 1\mu F$, $C_{OUT} = 10\mu F$)

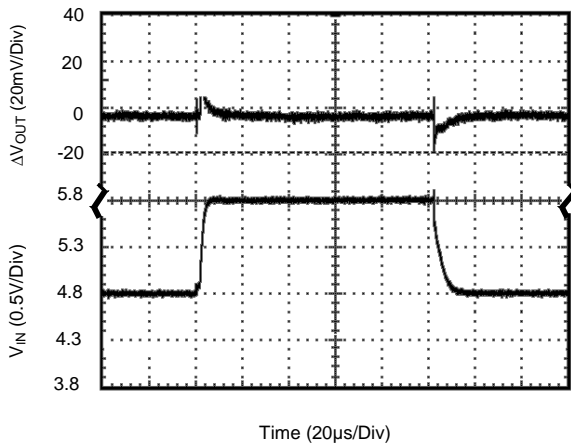

Load Transient Response
(Conditions: $V_{IN} = 4.8V$, $V_{OUT} = 3.33V$, $I_{OUT} = 0.1$ to $0.5A$, $C_{IN} = C_{OUT} = 10\mu F$)

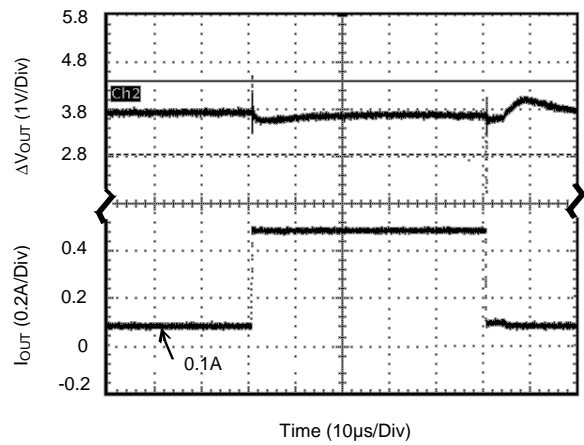

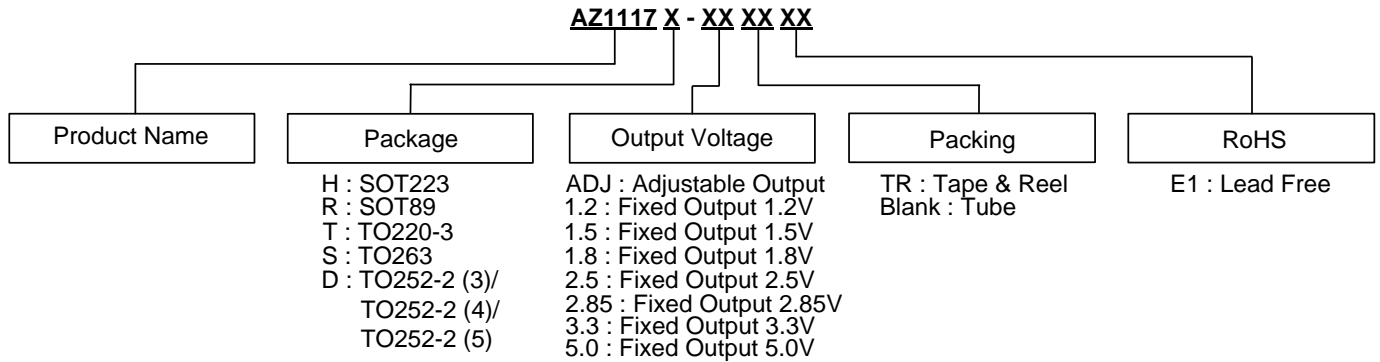
Ordering Information

Package	Temperature Range	Part Number	Marking ID	Packing
SOT223 (Note 5)	-40 to +125°C	AZ1117H-ADJTRE1	EH11A	4000/Tape & Reel
	-40 to +125°C	AZ1117H-1.2TRE1	EH18A	4000/Tape & Reel
	-40 to +125°C	AZ1117H-1.5TRE1	EH12A	4000/Tape & Reel
	-40 to +125°C	AZ1117H-1.8TRE1	EH13A	4000/Tape & Reel
	-40 to +125°C	AZ1117H-2.5TRE1	EH14A	4000/Tape & Reel
	-40 to +125°C	AZ1117H-2.85TRE1	EH15A	4000/Tape & Reel
	-40 to +125°C	AZ1117H-3.3TRE1	EH16A	4000/Tape & Reel
	-40 to +125°C	AZ1117H-5.0TRE1	EH17A	4000/Tape & Reel
SOT89 (Note 6)	-40 to +125°C	AZ1117R-ADJTRE1	E17A	1000/Tape & Reel
	-40 to +125°C	AZ1117R-1.2TRE1	E17G	1000/Tape & Reel
	-40 to +125°C	AZ1117R-1.5TRE1	E17B	1000/Tape & Reel
	-40 to +125°C	AZ1117R-1.8TRE1	E17C	1000/Tape & Reel
	-40 to +125°C	AZ1117R-2.5TRE1	E17D	1000/Tape & Reel
	-40 to +125°C	AZ1117R-2.85TRE1	E17H	1000/Tape & Reel
	-40 to +125°C	AZ1117R-3.3TRE1	E17E	1000/Tape & Reel
	-40 to +125°C	AZ1117R-5.0TRE1	E17F	1000/Tape & Reel
TO220-3	-40 to +125°C	AZ1117T-ADJE1	AZ1117T-ADJE1	50/Tube
	-40 to +125°C	AZ1117T-1.2E1	AZ1117T-1.2E1	50/Tube
	-40 to +125°C	AZ1117T-1.5E1	AZ1117T-1.5E1	50/Tube
	-40 to +125°C	AZ1117T-1.8E1	AZ1117T-1.8E1	50/Tube
	-40 to +125°C	AZ1117T-2.5E1	AZ1117T-2.5E1	50/Tube
	-40 to +125°C	AZ1117T-2.85E1	AZ1117T-2.85E1	50/Tube
	-40 to +125°C	AZ1117T-3.3E1	AZ1117T-3.3E1	50/Tube
	-40 to +125°C	AZ1117T-5.0E1	AZ1117T-5.0E1	50/Tube

Ordering Information (Cont.)

Package	Temperature Range	Part Number	Marking ID	Packing
TO252-2 (3)/(4)/(5) (Note 5)	-40 to +125°C	AZ1117D-ADJTRE1	AZ1117D-ADJE1	2500/Tape & Reel
	-40 to +125°C	AZ1117D-1.2TRE1	AZ1117D-1.2E1	2500/Tape & Reel
	-40 to +125°C	AZ1117D-1.5TRE1	AZ1117D-1.5E1	2500/Tape & Reel
	-40 to +125°C	AZ1117D-1.8TRE1	AZ1117D-1.8E1	2500/Tape & Reel
	-40 to +125°C	AZ1117D-2.5TRE1	AZ1117D-2.5E1	2500/Tape & Reel
	-40 to +125°C	AZ1117D-2.85TRE1	AZ1117D-2.85E1	2500/Tape & Reel
	-40 to +125°C	AZ1117D-3.3TRE1	AZ1117D-3.3E1	2500/Tape & Reel
	-40 to +125°C	AZ1117D-5.0TRE1	AZ1117D-5.0E1	2500/Tape & Reel
TO263	-40 to +125°C	AZ1117S-ADJTRE1	AZ1117S-ADJE1	800/Tape & Reel
	-40 to +125°C	AZ1117S-1.2TRE1	AZ1117S-1.2E1	800/Tape & Reel
	-40 to +125°C	AZ1117S-1.5TRE1	AZ1117S-1.5E1	800/Tape & Reel
	-40 to +125°C	AZ1117S-1.8TRE1	AZ1117S-1.8E1	800/Tape & Reel
	-40 to +125°C	AZ1117S-2.5TRE1	AZ1117S-2.5E1	800/Tape & Reel
	-40 to +125°C	AZ1117S-2.85TRE1	AZ1117S-2.85E1	800/Tape & Reel
	-40 to +125°C	AZ1117S-3.3TRE1	AZ1117S-3.3E1	800/Tape & Reel
	-40 to +125°C	AZ1117S-5.0TRE1	AZ1117S-5.0E1	800/Tape & Reel

Notes: 5. Not recommended for new design, please use AZ1117L.
6. Not recommended for new design, please use AZ1117C.

Marking Information

(1) SOT223 Series

(Top View)

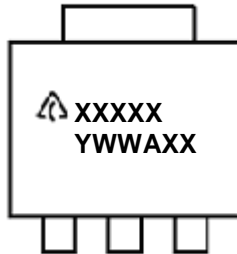

First Line: Logo and Marking ID (See Ordering Information)
 Second Line: Date Code
 Y: Year
 WW: Work Week of Molding
 A: Assembly House Code
 XX: 7th and 8th Digits of Batch Number

(2) TO252-2 Series

(Top View)

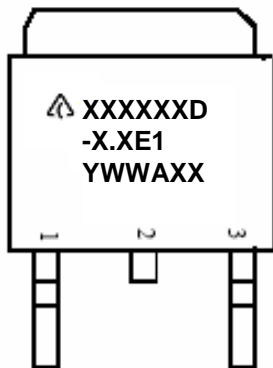

First and Second Lines: Logo and Marking ID (See Ordering Information)
 Third Line: Date Code
 Y: Year
 WW: Work Week of Molding
 A: Assembly House Code
 XX: 7th and 8th Digits of Batch Number

(3) SOT89

(Top View)

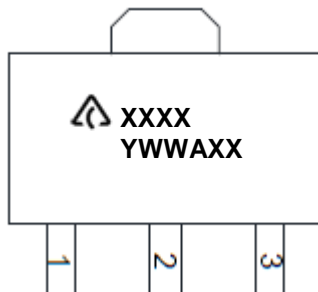

First Line: Logo and Marking ID (See Ordering Information)
 Second Line: Date Code
 Y: Year
 WW: Work Week of Molding
 A: Assembly House Code
 XX: 7th and 8th Digits of Batch Number

Marking Information (Cont.)

(4) TO220-3

(Top View)

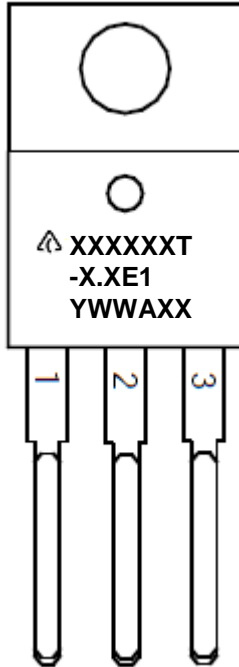

First and Second Lines: Logo and Marking ID
(See Ordering Information)
Third Line: Date Code
Y: Year
WW: Work Week of Molding
A: Assembly House Code
XX: 7th and 8th Digits of Batch Number

(5) TO263

(Top View)

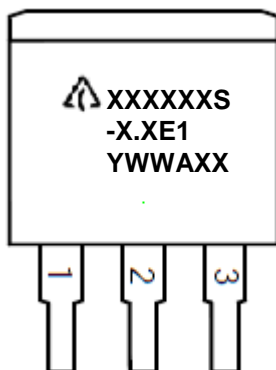

First and Second Lines: Logo and Marking ID
(See Ordering Information)
Third Line: Date Code
Y: Year
WW: Work Week of Molding
A: Assembly House Code
XX: 7th and 8th Digits of Batch Number

Package Outline Dimensions (All dimensions in mm (inch).)

(1) Package Type: SOT223

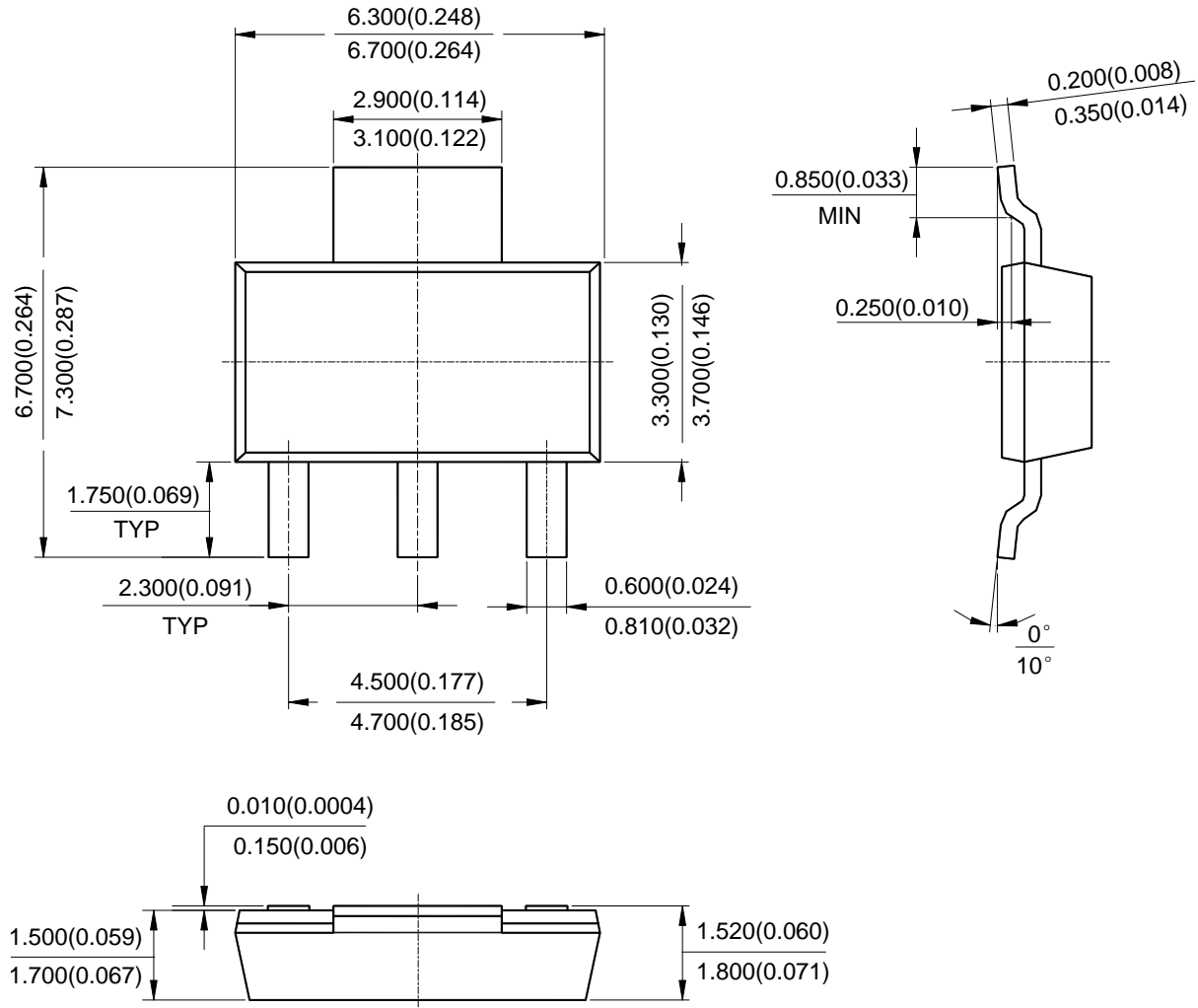

Package Outline Dimensions (Cont. All dimensions in mm(inch).)

(2) Package Type: SOT89

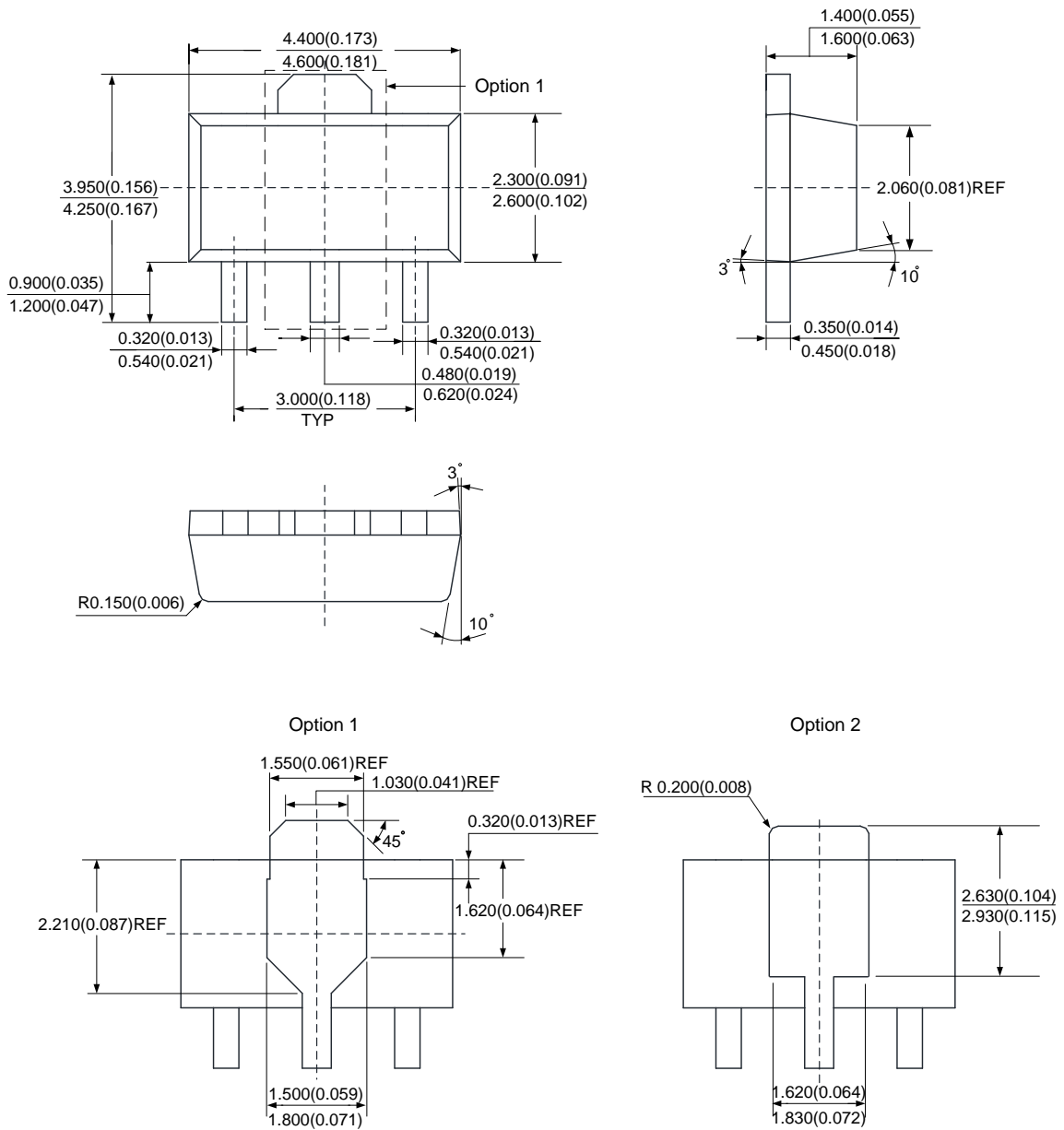

Package Outline Dimensions (Cont. All dimensions in mm(inch).)

(3) Package Type: TO252-2 (3)

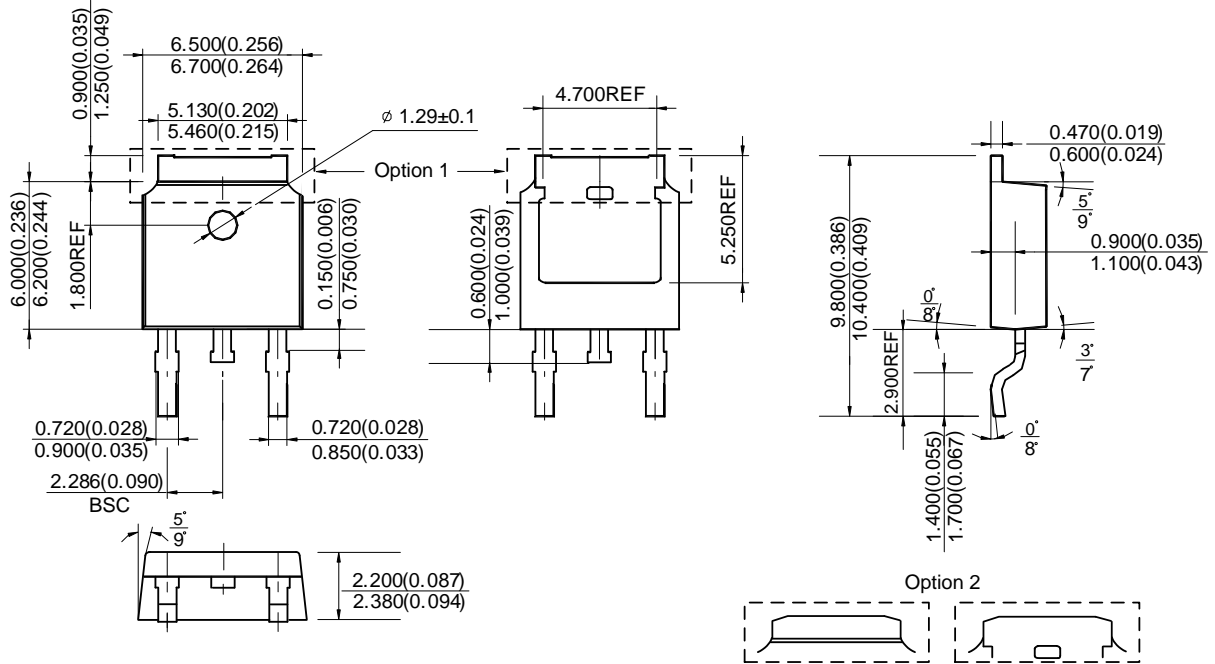

Package Outline Dimensions (Cont. All dimensions in mm(inch).)

(4) Package Type: TO252-2 (4)

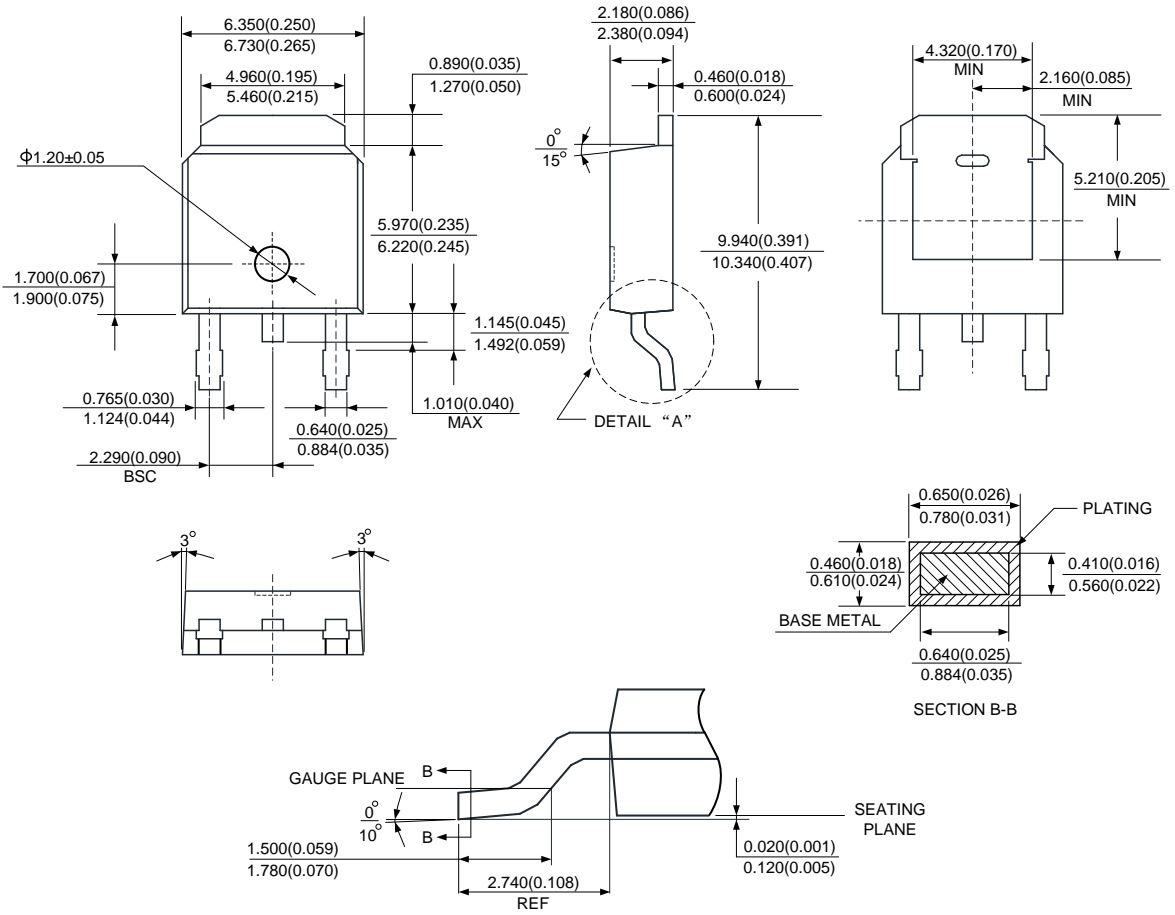

Package Outline Dimensions (Cont. All dimensions in mm(inch).)

(5) Package Type: TO252-2 (5)

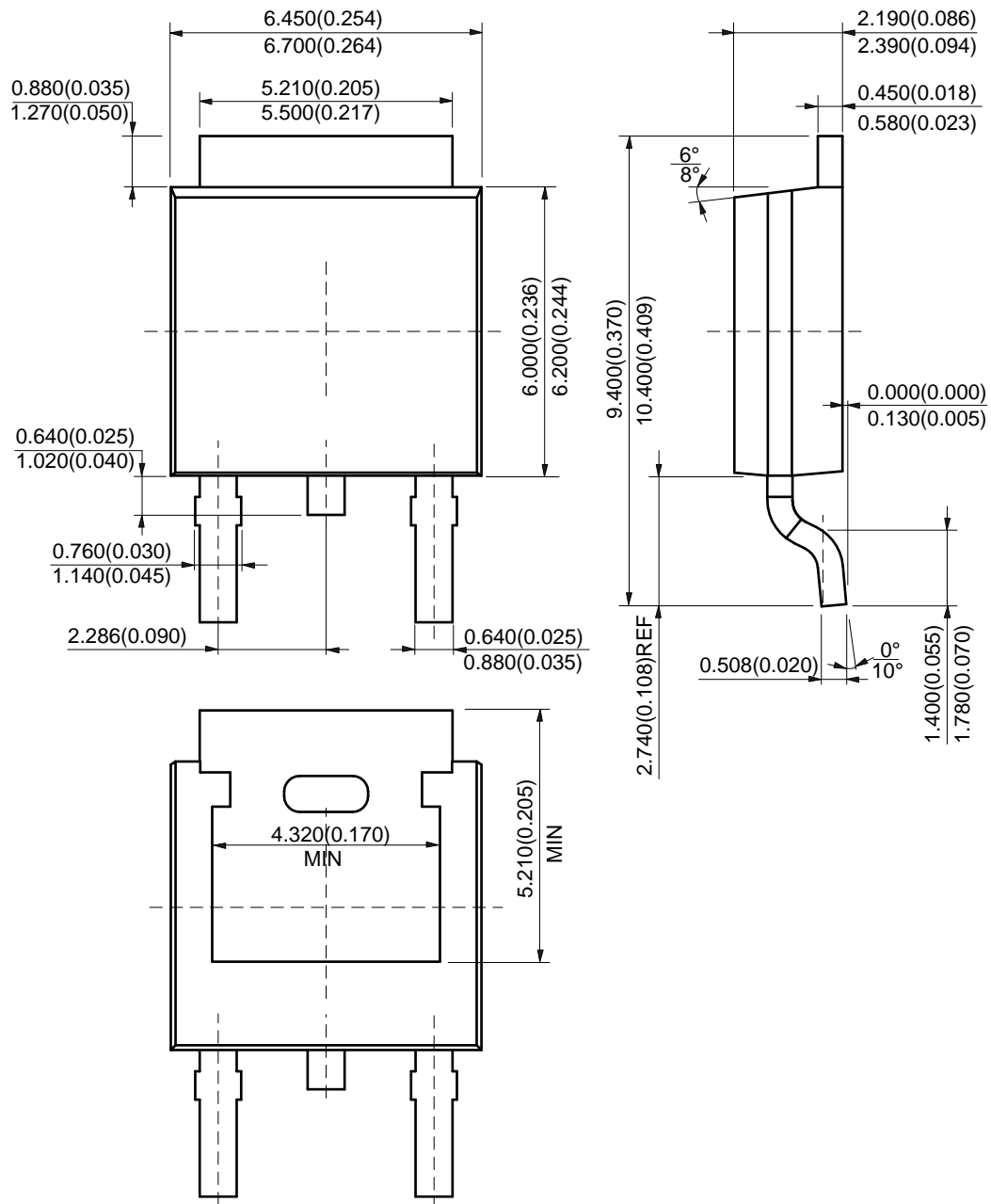

Package Outline Dimensions (Cont. All dimensions in mm(inch).)

(6) Package Type: TO220-3

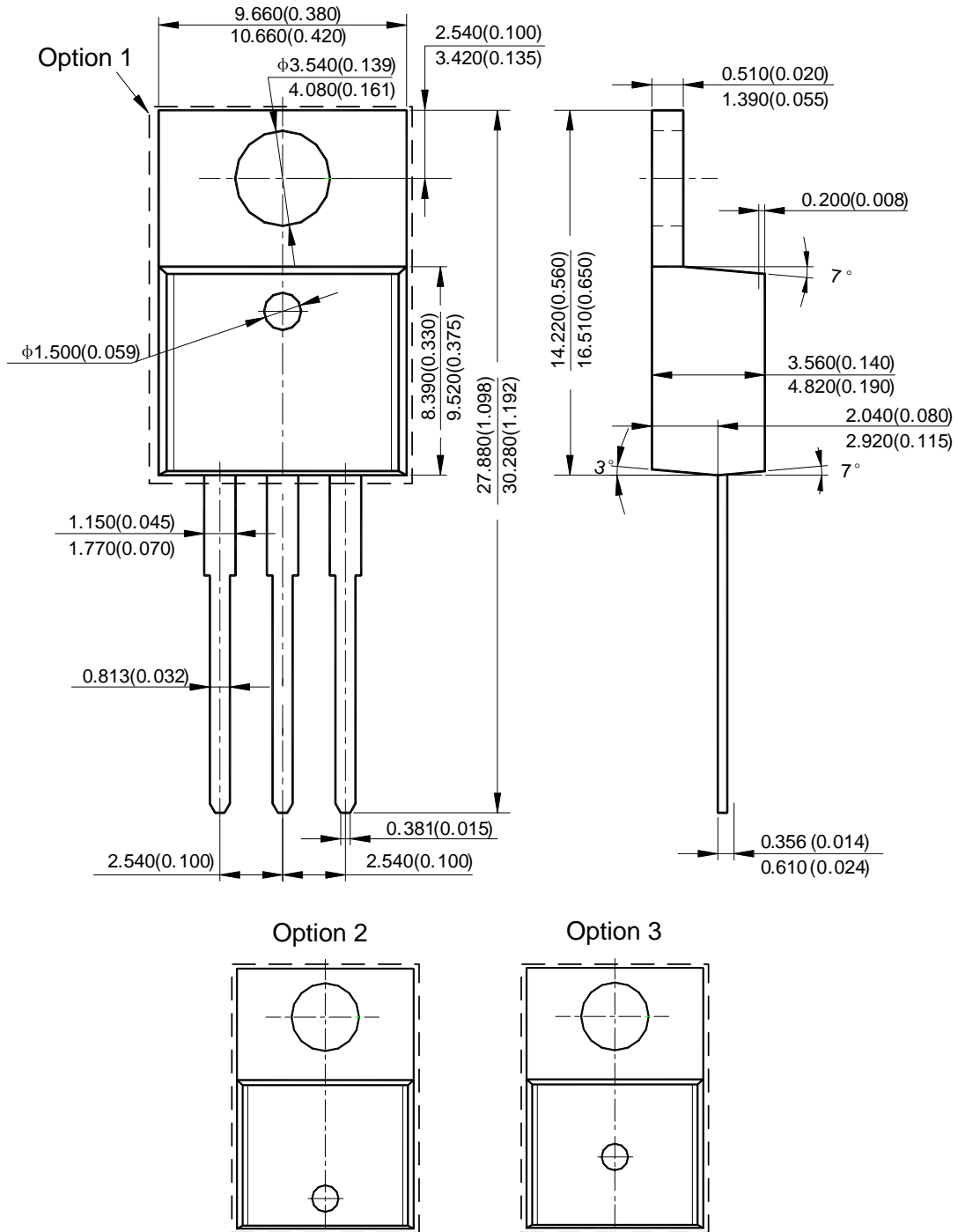

Package Outline Dimensions (Cont. All dimensions in mm(inch).)

(7) Package Type: TO263

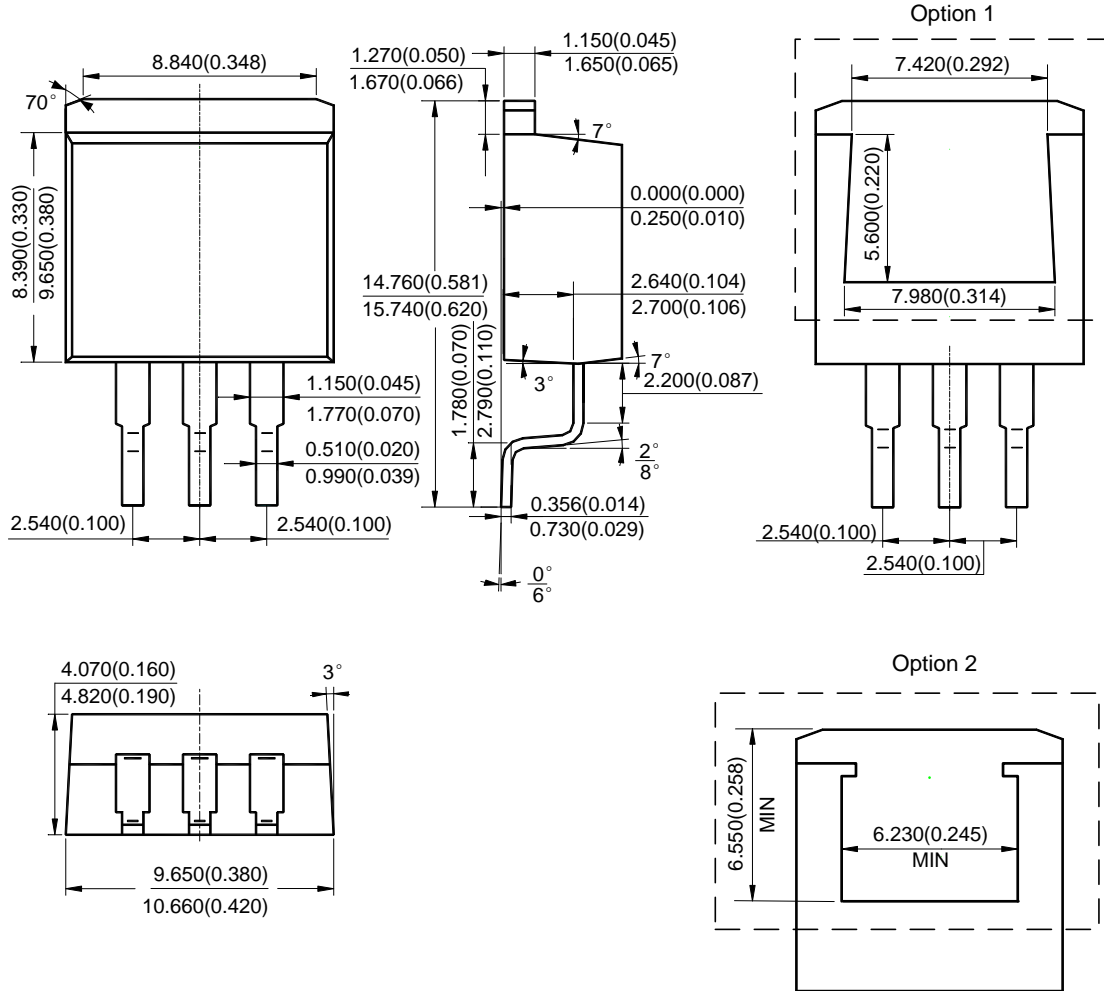

Suggested Pad Layout

(1) Package Type: SOT223

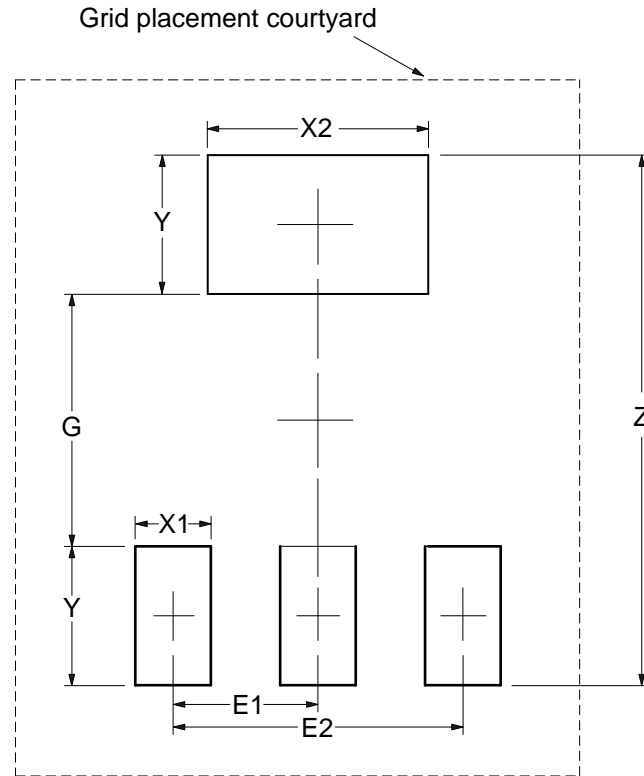

Dimensions	Z (mm)/(inch)	G (mm)/(inch)	X1 (mm)/(inch)	X2 (mm)/(inch)	Y (mm)/(inch)	E1 (mm)/(inch)	E2 (mm)/(inch)
Value	8.400/0.331	4.000/0.157	1.200/0.047	3.500/0.138	2.200/0.087	2.300/0.091	4.600/0.181

Suggested Pad Layout (Cont.)

(2) Package Type: SOT89

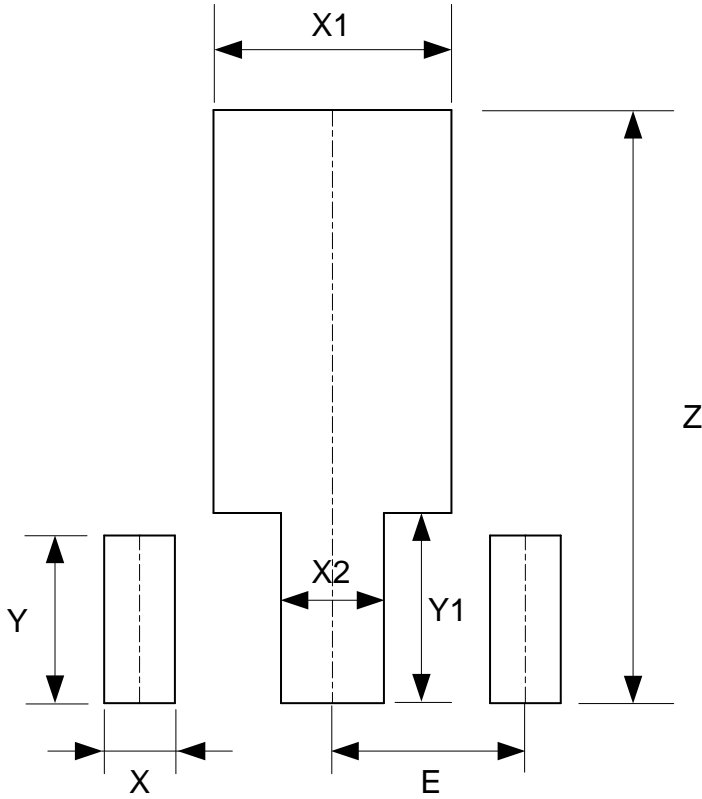

Dimensions	Z (mm)/(inch)	X (mm)/(inch)	X1 (mm)/(inch)	X2 (mm)/(inch)	Y (mm)/(inch)	Y1 (mm)/(inch)	E (mm)/(inch)
Value	4.600/0.181	0.550/0.022	1.850/0.073	0.800/0.031	1.300/0.051	1.475/0.058	1.500/0.059

Suggested Pad Layout (Cont.)

(3) Package Type: TO252-2 (3)

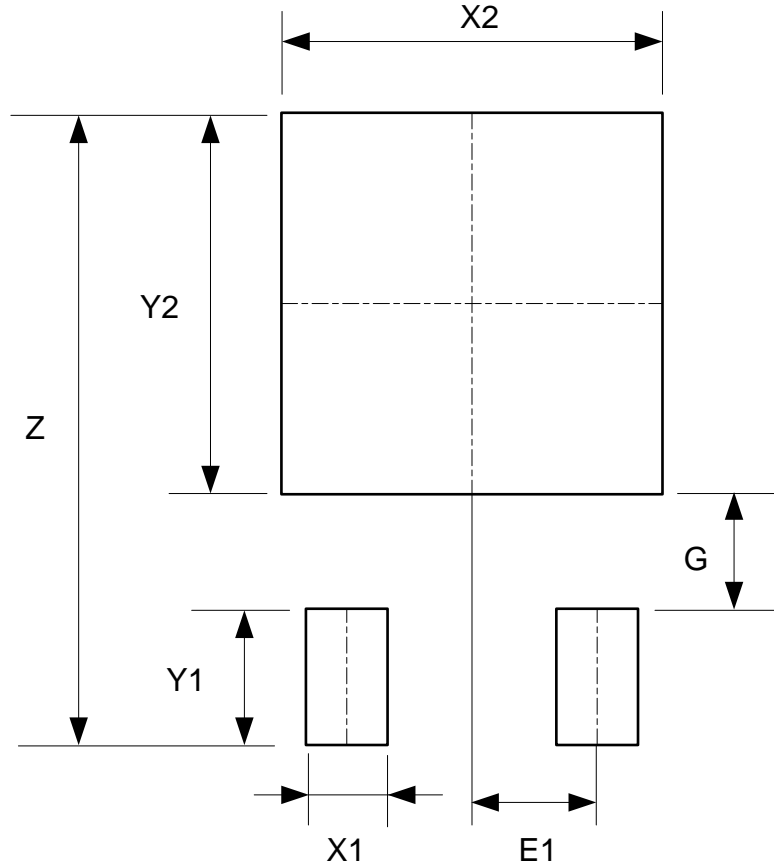

Dimensions	Z (mm)/(inch)	X1 (mm)/(inch)	X2=Y2 (mm)/(inch)	Y1 (mm)/(inch)	G (mm)/(inch)	E1 (mm)/(inch)
Value	11.600/0.457	1.500/0.059	7.000/0.276	2.500/0.098	2.100/0.083	2.300/0.091

Suggested Pad Layout (Cont.)

(4) Package Type: TO252-2 (4)

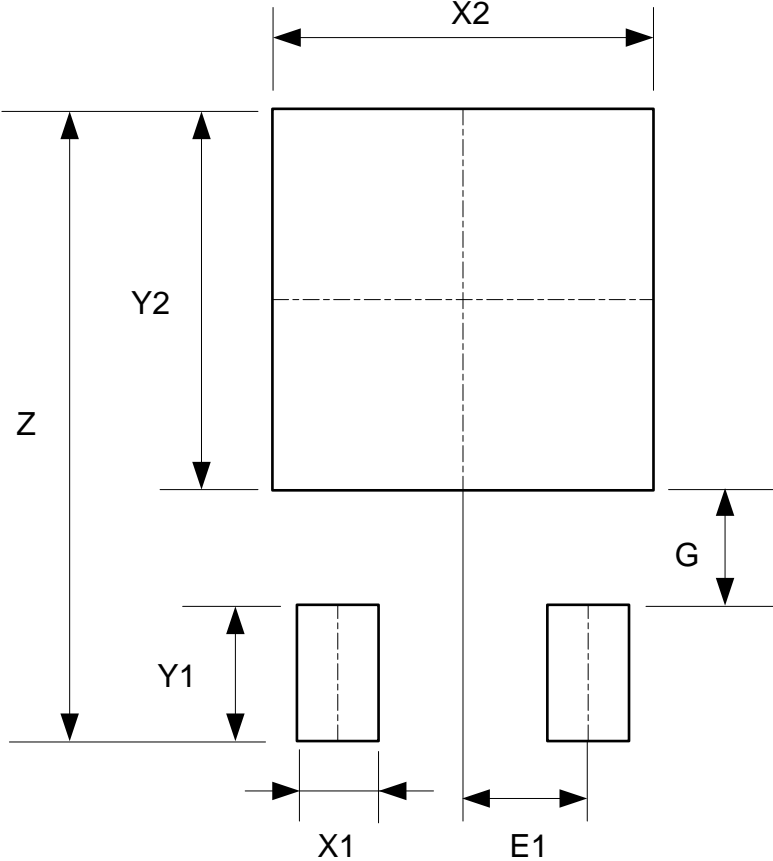

Dimensions	Z (mm)/(inch)	X1 (mm)/(inch)	X2=Y2 (mm)/(inch)	Y1 (mm)/(inch)	G (mm)/(inch)	E1 (mm)/(inch)
Value	11.600/0.457	1.500/0.059	7.000/0.276	2.500/0.098	2.100/0.083	2.300/0.091

Suggested Pad Layout (Cont.)

(5) Package Type: TO252-2 (5)

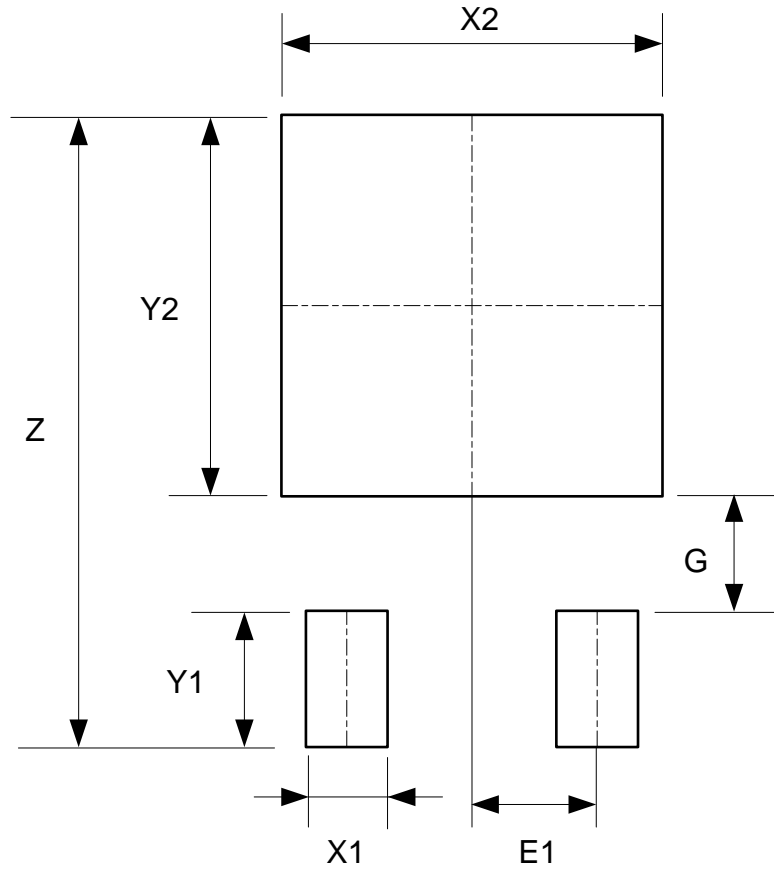

Dimensions	Z (mm)/(inch)	X1 (mm)/(inch)	X2=Y2 (mm)/(inch)	Y1 (mm)/(inch)	G (mm)/(inch)	E1 (mm)/(inch)
Value	11.600/0.457	1.500/0.059	7.000/0.276	2.500/0.098	2.100/0.083	2.300/0.091

Suggested Pad Layout (Cont.)

(6) Package Type: TO263

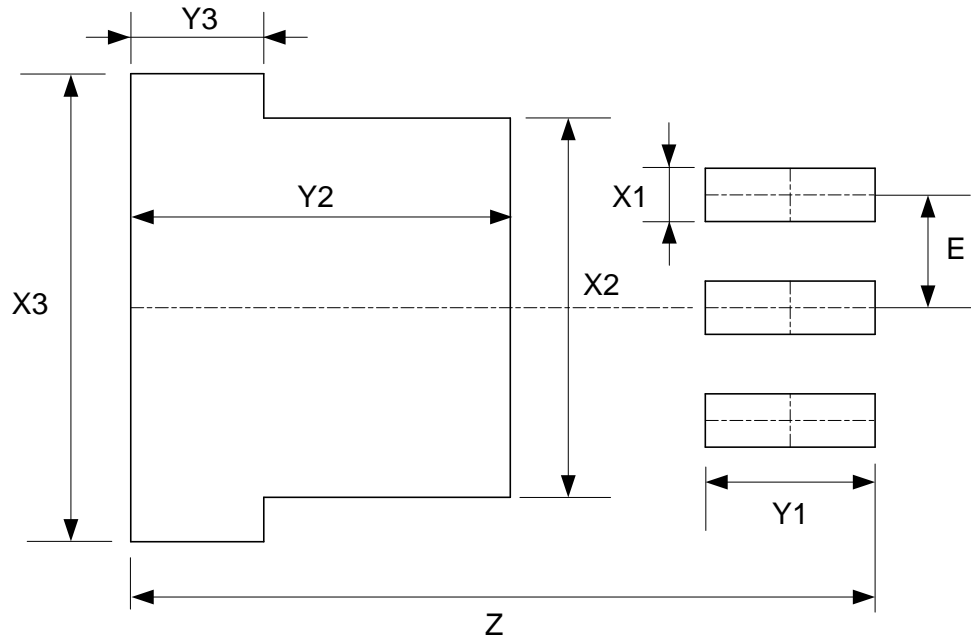

Dimensions	Z (mm)/(inch)	X1 (mm)/(inch)	X2 (mm)/(inch)	X3 (mm)/(inch)
Value	16.760/0.660	1.200/0.047	8.540/0.336	10.540/0.415
Dimensions	Y1 (mm)/(inch)	Y2 (mm)/(inch)	Y3 (mm)/(inch)	E (mm)/(inch)
Value	3.830/0.151	8.560/0.337	3.000/0.118	2.540/0.100

IMPORTANT NOTICE

DIODES INCORPORATED MAKES NO WARRANTY OF ANY KIND, EXPRESS OR IMPLIED, WITH REGARDS TO THIS DOCUMENT, INCLUDING, BUT NOT LIMITED TO, THE IMPLIED WARRANTIES OF MERCHANTABILITY AND FITNESS FOR A PARTICULAR PURPOSE (AND THEIR EQUIVALENTS UNDER THE LAWS OF ANY JURISDICTION).

Diodes Incorporated and its subsidiaries reserve the right to make modifications, enhancements, improvements, corrections or other changes without further notice to this document and any product described herein. Diodes Incorporated does not assume any liability arising out of the application or use of this document or any product described herein; neither does Diodes Incorporated convey any license under its patent or trademark rights, nor the rights of others. Any Customer or user of this document or products described herein in such applications shall assume all risks of such use and will agree to hold Diodes Incorporated and all the companies whose products are represented on Diodes Incorporated website, harmless against all damages.

Diodes Incorporated does not warrant or accept any liability whatsoever in respect of any products purchased through unauthorized sales channel. Should Customers purchase or use Diodes Incorporated products for any unintended or unauthorized application, Customers shall indemnify and hold Diodes Incorporated and its representatives harmless against all claims, damages, expenses, and attorney fees arising out of, directly or indirectly, any claim of personal injury or death associated with such unintended or unauthorized application.

Products described herein may be covered by one or more United States, international or foreign patents pending. Product names and markings noted herein may also be covered by one or more United States, international or foreign trademarks.

This document is written in English but may be translated into multiple languages for reference. Only the English version of this document is the final and determinative format released by Diodes Incorporated.

LIFE SUPPORT

Diodes Incorporated products are specifically not authorized for use as critical components in life support devices or systems without the express written approval of the Chief Executive Officer of Diodes Incorporated. As used herein:

A. Life support devices or systems are devices or systems which:

1. are intended to implant into the body, or
2. support or sustain life and whose failure to perform when properly used in accordance with instructions for use provided in the labeling can be reasonably expected to result in significant injury to the user.

B. A critical component is any component in a life support device or system whose failure to perform can be reasonably expected to cause the failure of the life support device or to affect its safety or effectiveness.

Customers represent that they have all necessary expertise in the safety and regulatory ramifications of their life support devices or systems, and acknowledge and agree that they are solely responsible for all legal, regulatory and safety-related requirements concerning their products and any use of Diodes Incorporated products in such safety-critical, life support devices or systems, notwithstanding any devices- or systems-related information or support that may be provided by Diodes Incorporated. Further, Customers must fully indemnify Diodes Incorporated and its representatives against any damages arising out of the use of Diodes Incorporated products in such safety-critical, life support devices or systems.

Copyright © 2016, Diodes Incorporated

www.diodes.com

Mouser Electronics

Authorized Distributor

Click to View Pricing, Inventory, Delivery & Lifecycle Information:

Diodes Incorporated:

[AZ1117H-ADJTRE1](#) [AZ1117R-3.3TRE1](#) [AZ1117R-5.0TRE1](#) [AZ1117R-1.8TRE1](#) [AZ1117R-ADJTRG1](#) [AZ1117R-ADJTRE1](#)