

# CPF0603B1M0E1 ✓ ACTIVE

Neohm | Neohm CPF

TE Internal #: 1-1879417-9

1M  $\Omega$ , Thin Film, Precision Resistor, .1 %, 2 Termination, 0603,  
Taped & Reeled, .063 W,  $\pm 25$  ppm/ $^{\circ}\text{C}$ , Solder, 1.55 x .8 x .45 mm,  
Neohm CPF

[View on TE.com >](#)



Passive Components > Resistors > Surface Mount Resistors



Resistor Type: **Precision Resistor**

Number of Terminations: **2**

Package Size Code: **0603**

Packaging Method: **Taped & Reeled**

Passive Component Tolerance: **.1 %**

## Features

### Product Type Features

Product Type	Fixed Resistor
Resistor Type	Precision Resistor
Package Size Code	0603
Element Type	Thin Film

### Configuration Features

Number of Resistors	1
---------------------	---

### Electrical Characteristics

Voltage Rating	50 V
Passive Component Tolerance	.1 %
Resistance Class	1M $\Omega$ – 1G $\Omega$
Resistance Value	1M $\Omega$
Power Rating	.063 W

### Termination Features

Number of Terminations	2
Surface Mount Resistor Termination Type	Solder

### Dimensions

Passive Component Dimensions	1.55 x .8 x .45 mm
------------------------------	--------------------

### Usage Conditions



Temperature Coefficient	$\pm 25$ ppm/ $^{\circ}$ C
-------------------------	----------------------------

**Packaging Features**

Packaging Method	Taped & Reeled
------------------	----------------

**Product Compliance**

For compliance documentation, visit the product page on TE.com>

EU RoHS Directive 2011/65/EU	Compliant
EU ELV Directive 2000/53/EC	Compliant
China RoHS 2 Directive MIIT Order No 32, 2016	No Restricted Materials Above Threshold
EU REACH Regulation (EC) No. 1907/2006	Current ECHA Candidate List: JUNE 2023 (235) Candidate List Declared Against: JUNE 2023 (235) Does not contain REACH SVHC
Halogen Content	Low Halogen - Br, Cl, F, I < 900 ppm per homogenous material. Also BFR/CFR/PVC Free
Solder Process Capability	Reflow solder capable to 260 $^{\circ}$ C

Product Compliance Disclaimer

This information is provided based on reasonable inquiry of our suppliers and represents our current actual knowledge based on the information they provided. This information is subject to change. The part numbers that TE has identified as EU RoHS compliant have a maximum concentration of 0.1% by weight in homogenous materials for lead, hexavalent chromium, mercury, PBB, PBDE, DBP, BBP, DEHP, DIBP, and 0.01% for cadmium, or qualify for an exemption to these limits as defined in the Annexes of Directive 2011/65/EU (RoHS2). Finished electrical and electronic equipment products will be CE marked as required by Directive 2011/65/EU. Components may not be CE marked. Additionally, the part numbers that TE has identified as EU ELV compliant have a maximum concentration of 0.1% by weight in homogenous materials for lead, hexavalent chromium, and mercury, and 0.01% for cadmium, or qualify for an exemption to these limits as defined in the Annexes of Directive 2000/53/EC (ELV). Regarding the REACH Regulation, the information TE provides on SVHC in articles for this part number is based on the latest European Chemicals Agency (ECHA) 'Guidance on requirements for substances in articles' posted at this URL: <https://echa.europa.eu/guidance-documents/guidance-on-reach>

**Compatible Parts**

 <p>TE Part # 2-1879213-8 CPF 0402 49R9 0.1% 25PPM 1K RL</p>	 <p>TE Part # 3-1879208-2 CPF 0402 200R 0.1% 25PPM 1K RL</p>	 <p>TE Part # 8-1879337-8 CPF 0603 20K 1% 50PPM 1K RL</p>	 <p>TE Part # 1-1614959-3 CPF0805 1M8 0.1% 25PPM 1K RL</p>
---	---	--	---



 <p>TE Part # 2-1879216-5 CPF 0402 90K9 0.1% 25PPM 1K RL</p>	 <p>TE Part # 8-1879213-5 CPF 0402 226R 0.1% 25PPM 1K RL</p>	 <p>TE Part # 7-1879213-5 CPF 0402 174R 0.1% 25PPM 1K RL</p>	 <p>TE Part # 3-1879215-8 CPF 0402 10K2 0.1% 25PPM 1K RL</p>
 <p>TE Part # 2-1879208-7 CPF 0402 120R 0.1% 25PPM 1K RL</p>	 <p>TE Part # 1-1879417-8 CPF 0603 910K 0.1% 25PPM 1K RL</p>	 <p>TE Part # 1-1879417-5 CPF 0603 680K 0.1% 25PPM 1K RL</p>	 <p>TE Part # 3-1879215-5 CPF 0402 9K31 0.1% 25PPM 1K RL</p>
 <p>TE Part # 4-1879214-5 CPF 0402 953R 0.1% 25PPM 1K RL</p>	 <p>TE Part # 3-1879216-0 CPF0402 120K 0.1% 25PPM 1K RL</p>	 <p>TE Part # 9-1879208-7 CPF 0402 100K 0.1% 25PPM 1K RL</p>	 <p>TE Part # 1614882-3 CPF0603 E 0.1% 1K0 1K RL</p>
 <p>TE Part # 3-1879336-3 CPF 0603 499R 1% 50PPM 1K RL</p>	 <p>TE Part # 8-1676481-1 CPF 0603 18K 0.1% 25PPM 1K RL</p>	 <p>TE Part # 8-1614882-9 CPF 0603 8R2 0.1% 25PPM 1K RL</p>	 <p>TE Part # 7-1879213-0 CPF 0402 154R 0.1% 25PPM 1K RL</p>

Also in the Series | **Neohm CPF**

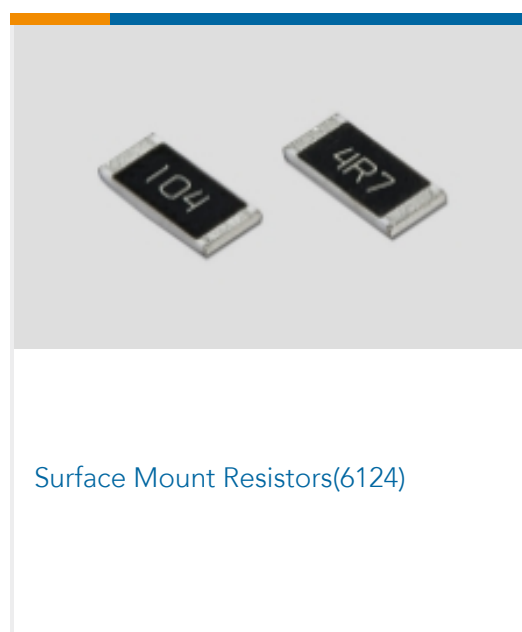

Customers Also Bought



TE Part #2-1761609-7  
IDC LOW PRO HDR 20P RA SHT LAT  
BLUE

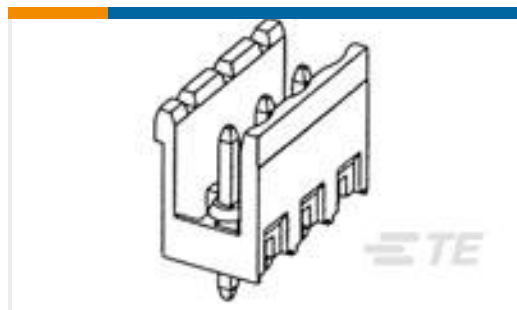

TE Part #282825-5  
TERMI-BLOK HEADER,ASSY90 5P.5,



TE Part #7-1879214-0  
CPF 0402 1K91 0.1% 25PPM 1K RL

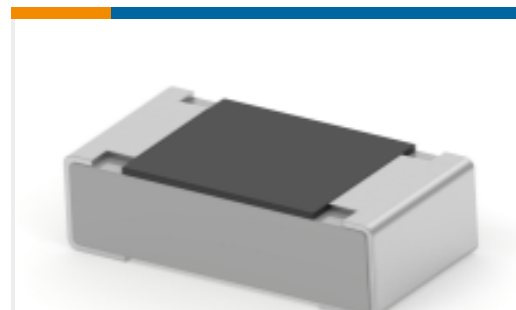

TE Part #2176340-8  
CRGCO 0603 15R 5%

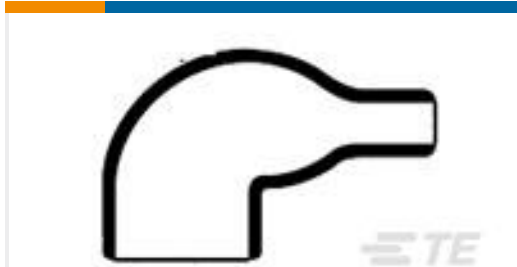

TE Part #806998-000  
222A152-3/86-0

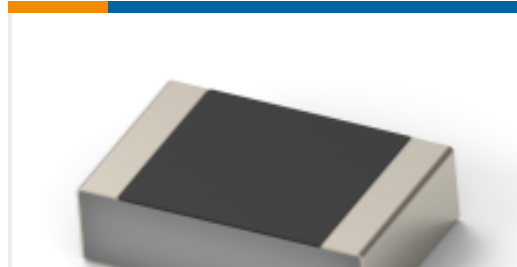

TE Part #2-2176453-4  
CPF 0201 10K 0.1% 25ppm 1K RL



TE Part #8-1879501-0  
CRGH2512 5% 2K0 2W



TE Part #6221-BCE-T-005-001  
5KPA GAUGE SENSOR

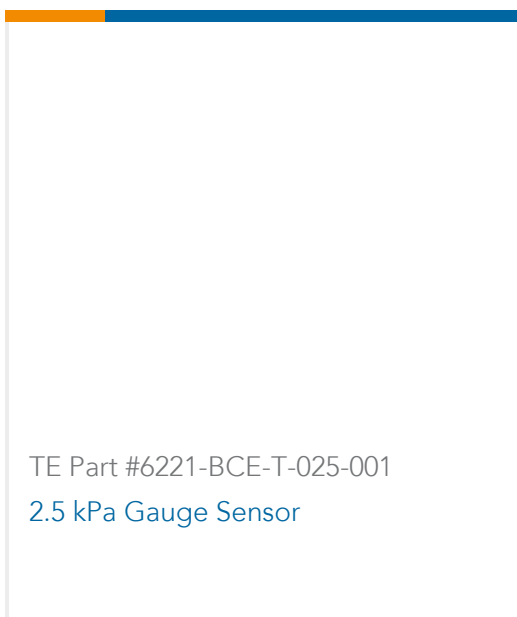

TE Part #6221-BCE-T-025-001  
2.5 kPa Gauge Sensor

## Documents

### Product Drawings

[CPF 0603 1M0 0.1% 25PPM 1K RL](#)

English

### CAD Files

[3D PDF](#)

3D

Customer View Model

[ENG\\_CVM\\_CVM\\_1-1879417-9\\_BA.2d\\_dxf.zip](#)

English

Customer View Model

[ENG\\_CVM\\_CVM\\_1-1879417-9\\_BA.3d\\_igs.zip](#)

English

Customer View Model

[ENG\\_CVM\\_CVM\\_1-1879417-9\\_BA.3d\\_stp.zip](#)

English

By downloading the CAD file I accept and agree to the [Terms and Conditions](#) of use.

### Datasheets & Catalog Pages



[1309350\\_PASSIVE\\_COMPONENT](#)

English

[CPF-1016](#)

English

[8-1773459-4\\_POWER\\_FILTERING\\_AND\\_RESISTIVE\\_SOLUTIONS\\_FOR\\_ELEVATORS\\_AND\\_ESCALATORS](#)

English

---

[Product Environmental Compliance](#)

[Product Compliance Document](#)

English

[Product Compliance Document](#)

English