



SCHOTTKY BARRIER RECTIFIERS

Reverse Voltage - 40 to 200 V

Forward Current - 20 A

FEATURES

- High current capability
- Low forward voltage drop
- Low power loss, high efficiency
- High surge capability
- High temperature soldering guaranteed
- Mounting position: any

TO-263W(D²PAK)

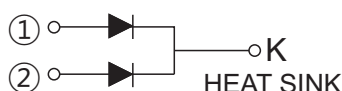
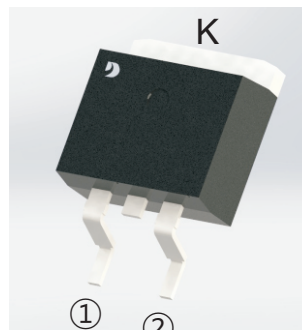

MAXIMUM RATINGS AND ELECTRICAL CHARACTERISTICS

Ratings at 25°C ambient temperature unless otherwise specified

CHARACTERISTICS	SYMBOL	MBR2040GT	MBR2045GT	MBR2060GT	MBR20100GT	MBR20150GT	MBR20200GT	Units	
Maximum Recurrent Peak Reverse Voltage	V_{RRM}	40	45	60	100	150	200	V	
Maximum RMS voltage	V_{RMS}	28	32	42	70	105	140	V	
Maximum DC Blocking Voltage	V_{DC}	40	45	60	100	150	200	V	
Maximum Average Forward Rectified Current per diode per device	$I_{F(AV)}$	10 20						A	
Peak Forward Surge Current, 8.3ms Single Half Sine-wave Superimposed on Rated Load (JEDEC method) per diode	I_{FSM}	150						A	
Max Instantaneous Forward Voltage at 10 A DC Per leg	V_F	0.70		0.75	0.85	0.90	0.92	V	
Maximum DC Reverse Current at Rated DC Reverse Voltage $T_a = 25^\circ\text{C}$ $T_a = 125^\circ\text{C}$	I_R	0.1 20			0.05 20			mA	
Typical Junction Capacitance ⁽¹⁾	C_j	600		400				pF	
Typical Thermal Resistance ⁽²⁾	$R_{\theta JA}$	45						°C/W	
Operating Junction Temperature Range	T_j	-55 ~ +150				-55 ~ +175			°C
Storage Temperature Range	T_{stg}	-55 ~ +150				-55 ~ +175			°C

(1) Measured at 1 MHz and applied reverse voltage of 4 V D.C

(2) P.C.B. mounted with 10cmX10cmX1mm copper pad areas.



Fig.1 TYPICAL FORWARD CURRENT DERATING CURVE

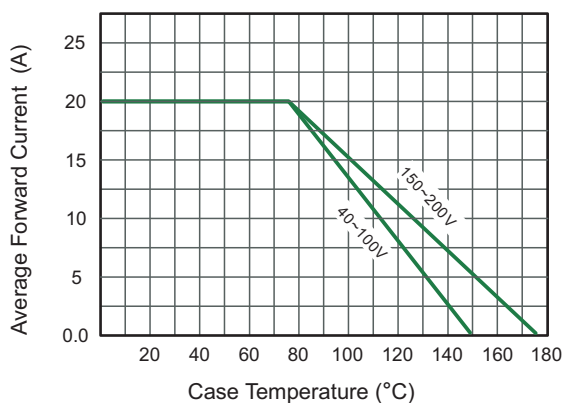

Fig.2 Typical Reverse Characteristics

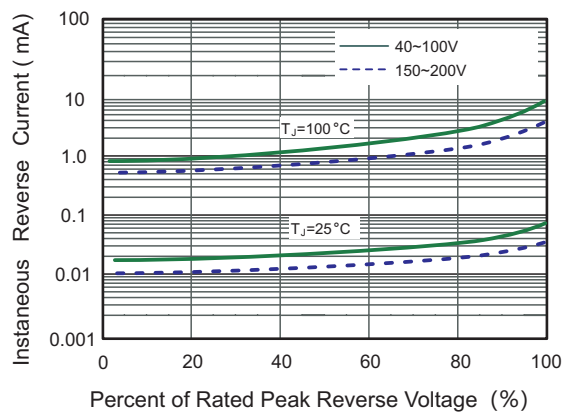

Fig.3 Typical Forward Characteristic(per leg)

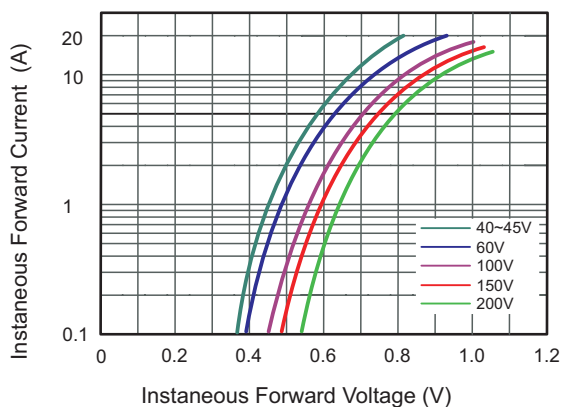

Fig.4 Typical Junction Capacitance

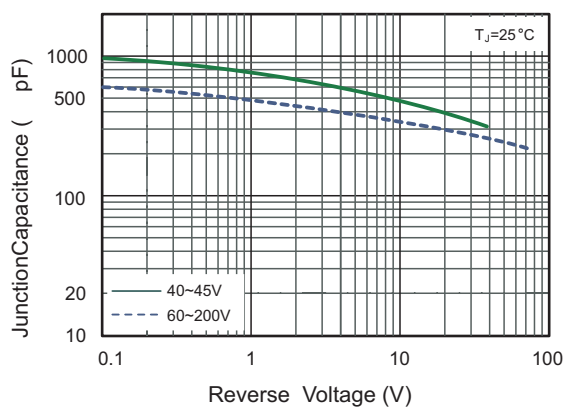

Fig.5 Maximum Non-Repetitive Peak Forward Surge Current

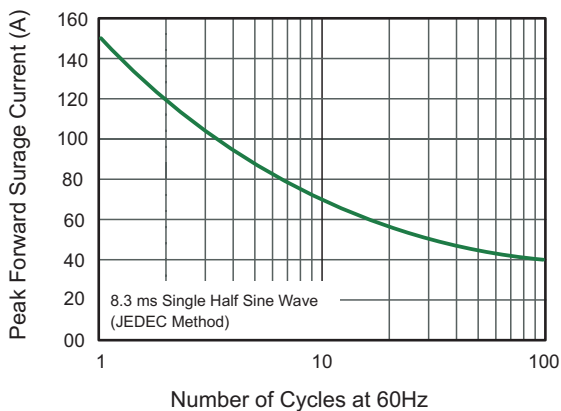
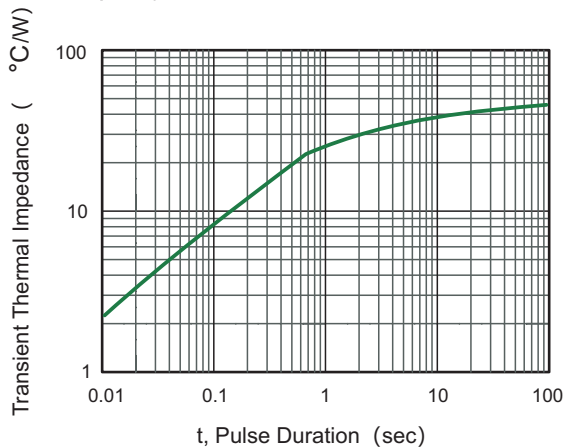
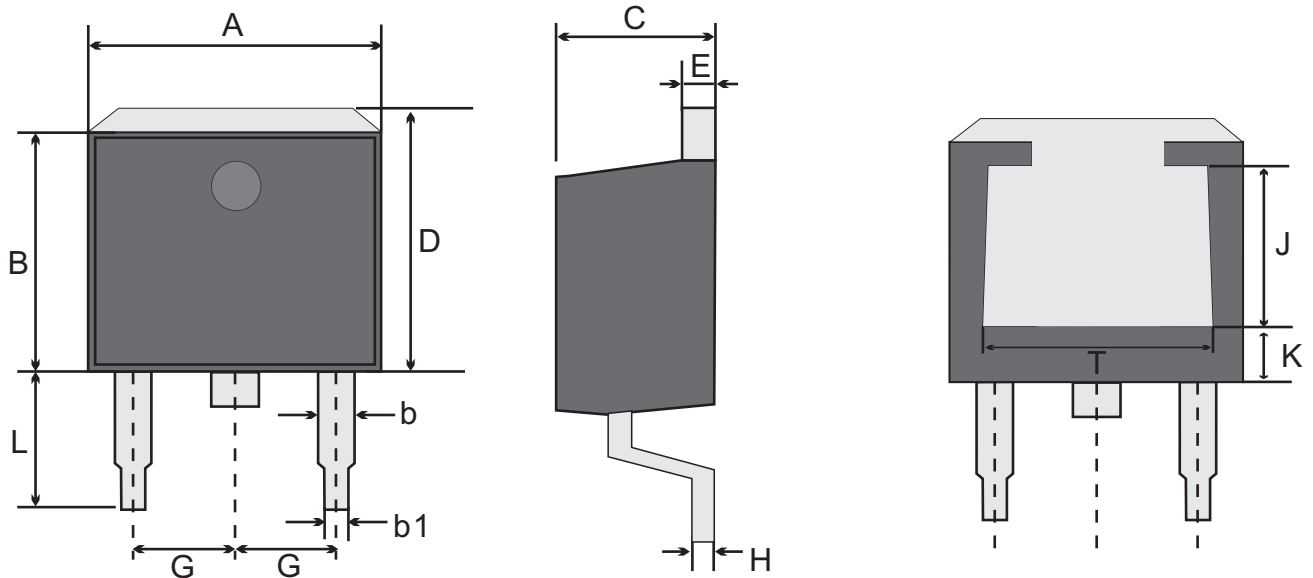

Fig.6- Typical Transient Thermal Impedance





TO-263(D²PAK) Package Outline Dimensions



TO-263W(D²PAK) mechanical data

UNIT		A	B	b	b1	C	D	E	G	H	L	J	T	K
mm	max	10.4	9.1	1.4	0.9	4.8	10.6	1.40	2.75	0.7	6.0	4.65 ref.	7.70 ref.	3.22 ref.
	typ	9.94	8.6	1.2	0.8	4.53	9.8	1.27	2.5	0.38	5.5			
	min	9.8	8.5	1.0		4.4	9.6	1.20	2.35	0.3	5.0			
mil	max	409	357	55	35	189	418	55	108	26	236	1.83 ref.	303 ref.	126 ref.
	typ	391	338	47		178	386	50	98	15	216			
	min	387	335	39		173	378	47	92	11	197			

MARKING DIAGRAM

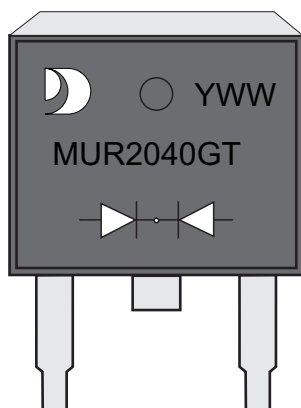

YWW: Date Code
Y:Years(0~9)
WW:Week
MUR2040GT: Product name
(NOTE: The weekly code is based on the actual number of weeks in the calendar year.)



Important Notice and Disclaimer

Jingdao Microelectronics reserves the right to make changes to this document and its products and specifications at any time without notice. Customers should obtain and confirm the latest product information and specifications before final design, purchase or use.

Jingdao Microelectronics makes no warranty, representation or guarantee regarding the suitability of its products for any particular purpose, nor does Jingdao Microelectronics assume any liability for application assistance or customer product design.

Jingdao Microelectronics does not warrant or accept any liability with products which are purchased or used for any unintended or unauthorized application.

No license is granted by implication or otherwise under any intellectual property rights of Jingdao Microelectronics.

Jingdao Microelectronics products are not authorized for use as critical components in life support devices or systems without express written approval of Jingdao Microelectronics.