

ICL7611, ICL7612

1.4MHz, Low Power CMOS Operational Amplifiers

FN2919  
Rev 9.00  
April 26, 2007

The ICL761X series is a family of CMOS operational amplifiers. These devices provide the designer with high performance operation at low supply voltages and selectable quiescent currents, and are an ideal design tool when ultra low input current and low power dissipation are desired.

The basic amplifier will operate at supply voltages ranging from  $\pm 1V$  to  $\pm 8V$ , and may be operated from a single Lithium cell.

A unique quiescent current programming pin allows setting of standby current to 1mA, 100 $\mu A$ , or 10 $\mu A$ , with no external components. This results in power consumption as low as 20 $\mu W$ . The output swing ranges to within a few millivolts of the supply voltages.

Of particular significance is the extremely low (1pA) input current, input noise current of 0.01pA/ $\sqrt{Hz}$ , and 10<sup>12</sup> $\Omega$  input impedance. These features optimize performance in very high source impedance applications.

The inputs are internally protected. Outputs are fully protected against short circuits to ground or to either supply.

AC performance is excellent, with a slew rate of 1.6V/ $\mu s$ , and unity gain bandwidth of 1MHz at I<sub>Q</sub> = 1mA.

Because of the low power dissipation, junction temperature rise and drift are quite low. Applications utilizing these features may include stable instruments, extended life designs, or high density packages.

**Pinouts**

ICL7611, ICL7612  
(8 LD PDIP, 8 LD SOIC)  
TOP VIEW

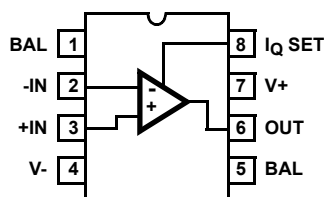

**Features**

- Wide Operating Voltage Range . . . . .  $\pm 1V$  to  $\pm 8V$
- High Input Impedance . . . . . 10<sup>12</sup> $\Omega$
- Programmable Power Consumption . . . . . Low as 20 $\mu W$
- Input Current Lower Than BIFETs . . . . . 1pA (Typ)
- Output Voltage Swing . . . . . V+ and V-
- Input Common Mode Voltage Range Greater Than Supply Rails (ICL7612)
- Pb-Free Plus Anneal Available (RoHS Compliant)

**Applications**

- Portable Instruments
- Telephone Headsets
- Hearing Aid/Microphone Amplifiers
- Meter Amplifiers
- Medical Instruments
- High Impedance Buffers

**Ordering Information**

PART NUMBER	PART MARKING	TEMP. RANGE (°C)	PACKAGE	PKG. DWG. #
ICL7611DCBA	7611 DCBA	0 to +70	8 Ld SOIC (150 mil)	M8.15
ICL7611DCBAZ (Note)	7611 DCBAZ	0 to +70	8 Ld SOIC (150 mil) (Pb-free)	M8.15
ICL7611DCBA-T	7611 DCBA	0 to +70	8 Ld SOIC (150 mil) Tape and Reel	M8.15
ICL7611DCBAZ-T (Note)	7611 DCBAZ	0 to +70	8 Ld SOIC (150 mil) Tape and Reel (Pb-free)	M8.15
ICL7611DCPA	7611 DCPA	0 to +70	8 Ld PDIP	E8.3
ICL7611DCPAZ (Note)	7611 DCPAZ	0 to +70	8 Ld PDIP* (Pb-free)	E8.3
ICL7612BCPA	7612 BCPA	0 to +70	8 Ld PDIP	E8.3
ICL7612BCPAZ	7612 BCPAZ	0 to +70	8 Ld PDIP* (Pb-free)	E8.3
ICL7612DCBA	7612 DCBA	0 to +70	8 Ld SOIC (150 mil)	M8.15
ICL7612DCBA-T	7612 DCBA	0 to +70	8 Ld SOIC (150 mil) Tape and Reel	M8.15
ICL7612DCBAZ (Note)	7612 DCBAZ	0 to +70	8 Ld SOIC (150 mil) (Pb-free)	M8.15
ICL7612DCBAZ-T (Note)	7612 DCBAZ	0 to +70	8 Ld SOIC (150 mil) Tape and Reel (Pb-free)	M8.15
ICL7612DCPA	7612 DCPA	0 to +70	8 Ld PDIP	E8.3
ICL7612DCPAZ (Note)	7612 DCPAZ	0 to +70	8 Ld PDIP* (Pb-free)	E8.3

\*Pb-free PDIPs can be used for through hole wave solder processing only. They are not intended for use in Reflow solder processing applications.  
 NOTE: Intersil Pb-free plus anneal products employ special Pb-free material sets; molding compounds/die attach materials and 100% matte tin plate termination finish, which are RoHS compliant and compatible with both SnPb and Pb-free soldering operations. Intersil Pb-free products are MSL classified at Pb-free peak reflow temperatures that meet or exceed the Pb-free requirements of IPC/JEDEC J STD-020.

**Absolute Maximum Ratings**

Supply Voltage V+ to V- ..... 18V  
 Input Voltage ..... V- -0.3 to V+ +0.3V  
 Differential Input Voltage (Note 1) ..... [(V+ +0.3) - (V- -0.3)]V  
 Duration of Output Short Circuit (Note 2) ..... Unlimited

**Operating Conditions**

Temperature Range  
 ICL761XC ..... 0°C to +70°C

**Thermal Information**

Thermal Resistance (Typical, Note 3)  $\theta_{JA}$  (°C/W)  
 PDIP Package\* ..... 130  
 SOIC Package ..... 170  
 Maximum Junction Temperature (Plastic Package) ..... +150°C  
 Maximum Storage Temperature Range ..... -65°C to +150°C  
 Pb-free reflow profile ..... see link below  
<http://www.intersil.com/pbfree/Pb-FreeReflow.asp>

\*Pb-free PDIPs can be used for through hole wave solder processing only. They are not intended for use in Reflow solder processing applications.

*CAUTION: Stresses above those listed in "Absolute Maximum Ratings" may cause permanent damage to the device. This is a stress only rating and operation of the device at these or any other conditions above those indicated in the operational sections of this specification is not implied.*

**NOTES:**

1. Long term offset voltage stability will be degraded if large input differential voltages are applied for long periods of time.
2. The outputs may be shorted to ground or to either supply, for  $V_{SUPPLY} \leq 10V$ . Care must be taken to insure that the dissipation rating is not exceeded.
3.  $\theta_{JA}$  is measured with the component mounted on an evaluation PC board in free air.

**Electrical Specifications**  $V_{SUPPLY} = \pm 5V$ , Unless Otherwise Specified.

PARAMETER	SYMBOL	TEST CONDITIONS	TEMP (°C)	ICL7612B			ICL7611D, ICL7612D			UNITS
				MIN	TYP	MAX	MIN	TYP	MAX	
Input Offset Voltage	$V_{OS}$	$R_S \leq 100k\Omega$	+25	-	-	5	-	-	15	mV
			Full	-	-	7	-	-	20	mV
Temperature Coefficient of $V_{OS}$	$\Delta V_{OS}/\Delta T$	$R_S \leq 100k\Omega$	-	-	15	-	-	25	-	$\mu V/^\circ C$
Input Offset Current	$I_{OS}$		+25	-	0.5	30	-	0.5	30	pA
			Full	-	-	300	-	-	300	pA
Input Bias Current	$I_{BIAS}$		+25	-	1.0	50	-	1.0	50	pA
			Full	-	-	400	-	-	400	pA
Common Mode Voltage Range (ICL7611 Only)	$V_{CMR}$	$I_Q = 10\mu A$	+25	-	-	-	$\pm 4.4$	-	-	V
		$I_Q = 100\mu A$	+25	-	-	-	$\pm 4.2$	-	-	V
		$I_Q = 1mA$	+25	-	-	-	$\pm 3.7$	-	-	V
Extended Common Mode Voltage Range (ICL7612 Only)	$V_{CMR}$	$I_Q = 10\mu A$	+25	$\pm 5.3$	-	-	$\pm 5.3$	-	-	V
		$I_Q = 100\mu A$	+25	+5.3, -5.1	-	-	+5.3, -5.1	-	-	V
		$I_Q = 1mA$	+25	+5.3, -4.5	-	-	+5.3, -4.5	-	-	V
Output Voltage Swing	$V_{OUT}$	$I_Q = 10\mu A, R_L = 1M\Omega$	+25	$\pm 4.9$	-	-	$\pm 4.9$	-	-	V
			Full	$\pm 4.8$	-	-	$\pm 4.8$	-	-	V
		$I_Q = 100\mu A, R_L = 100k\Omega$	+25	$\pm 4.9$	-	-	$\pm 4.9$	-	-	V
			Full	$\pm 4.8$	-	-	$\pm 4.8$	-	-	V
		$I_Q = 1mA, R_L = 10k\Omega$	+25	$\pm 4.5$	-	-	$\pm 4.5$	-	-	V
			Full	$\pm 4.3$	-	-	$\pm 4.3$	-	-	V
Large Signal Voltage Gain	$A_{VOL}$	$V_O = \pm 4.0V, R_L = 1M\Omega, I_Q = 10\mu A$	+25	80	104	-	80	104	-	dB
			Full	75	-	-	75	-	-	dB
		$V_O = \pm 4.0V, R_L = 100k\Omega, I_Q = 100\mu A$	+25	80	102	-	80	102	-	dB
			Full	75	-	-	75	-	-	dB
		$V_O = \pm 4.0V, R_L = 10k\Omega, I_Q = 1mA$	+25	76	83	-	76	83	-	dB
			Full	72	-	-	72	-	-	dB

**Electrical Specifications**  $V_{SUPPLY} = \pm 5V$ , Unless Otherwise Specified. (Continued)

PARAMETER	SYMBOL	TEST CONDITIONS	TEMP (°C)	ICL7612B			ICL7611D, ICL7612D			UNITS
				MIN	TYP	MAX	MIN	TYP	MAX	
Unity Gain Bandwidth	GBW	$I_Q = 10\mu A$	+25	-	0.044	-	-	0.044	-	MHz
		$I_Q = 100\mu A$	+25	-	0.48	-	-	0.48	-	MHz
		$I_Q = 1mA$	+25	-	1.4	-	-	1.4	-	MHz
Input Resistance	$R_{IN}$		+25	-	$10^{12}$	-	-	$10^{12}$	-	$\Omega$
Common Mode Rejection Ratio	CMRR	$R_S \leq 100k\Omega, I_Q = 10\mu A$	+25	70	96	-	70	96	-	dB
		$R_S \leq 100k\Omega, I_Q = 100\mu A$	+25	70	91	-	70	91	-	dB
		$R_S \leq 100k\Omega, I_Q = 1mA$	+25	60	87	-	60	87	-	dB
Power Supply Rejection Ratio ( $V_{SUPPLY} = \pm 8V$ to $\pm 2V$ )	PSRR	$R_S \leq 100k\Omega, I_Q = 10\mu A$	+25	80	94	-	80	94	-	dB
		$R_S \leq 100k\Omega, I_Q = 100\mu A$	+25	80	86	-	80	86	-	dB
		$R_S \leq 100k\Omega, I_Q = 1mA$	+25	70	77	-	70	77	-	dB
Input Referred Noise Voltage	$e_N$	$R_S = 100\Omega, f = 1kHz$	+25	-	100	-	-	100	-	$nV/\sqrt{Hz}$
Input Referred Noise Current	$i_N$	$R_S = 100\Omega, f = 1kHz$	+25	-	0.01	-	-	0.01	-	$pA/\sqrt{Hz}$
Supply Current (No Signal, No Load)	$I_{SUPPLY}$	$I_Q SET = +5V, Low Bias$	+25	-	0.01	0.02	-	0.01	0.02	mA
		$I_Q SET = 0V, Medium Bias$	+25	-	0.1	0.25	-	0.1	0.25	mA
		$I_Q SET = -5V, High Bias$	+25	-	1.0	2.5	-	1.0	2.5	mA
Channel Separation	$V_{O1}/V_{O2}$	$A_V = 100$	+25	-	120	-	-	120	-	dB
Slew Rate ( $A_V = 1, C_L = 100pF, V_{IN} = 8V_{P-P}$ )	SR	$I_Q = 10\mu A, R_L = 1M\Omega$	+25	-	0.016	-	-	0.016	-	$V/\mu s$
		$I_Q = 100\mu A, R_L = 100k\Omega$	+25	-	0.16	-	-	0.16	-	$V/\mu s$
		$I_Q = 1mA, R_L = 10k\Omega$	+25	-	1.6	-	-	1.6	-	$V/\mu s$
Rise Time ( $V_{IN} = 50mV, C_L = 100pF$ )	$t_r$	$I_Q = 10\mu A, R_L = 1M\Omega$	+25	-	20	-	-	20	-	$\mu s$
		$I_Q = 100\mu A, R_L = 100k\Omega$	+25	-	2	-	-	2	-	$\mu s$
		$I_Q = 1mA, R_L = 10k\Omega$	+25	-	0.9	-	-	0.9	-	$\mu s$
Overshoot Factor ( $V_{IN} = 50mV, C_L = 100pF$ )	OS	$I_Q = 10\mu A, R_L = 1M\Omega$	+25	-	5	-	-	5	-	%
		$I_Q = 100\mu A, R_L = 100k\Omega$	+25	-	10	-	-	10	-	%
		$I_Q = 1mA, R_L = 10k\Omega$	+25	-	40	-	-	40	-	%

**Electrical Specifications**  $V_{SUPPLY} = \pm 1V, I_Q = 10\mu A$ , Unless Otherwise Specified.

PARAMETER	SYMBOL	TEST CONDITIONS	TEMP (°C)	ICL7612B			UNITS
				MIN	TYP	MAX	
Input Offset Voltage	$V_{OS}$	$R_S \leq 100k\Omega$	+25	-	-	5	mV
			Full	-	-	7	mV
Temperature Coefficient of $V_{OS}$	$\Delta V_{OS}/\Delta T$	$R_S \leq 100k\Omega$	-	-	15	-	$\mu V/^\circ C$
Input Offset Current	$I_{OS}$		+25	-	0.5	30	pA
			Full	-	-	300	pA
Input Bias Current	$I_{BIAS}$		+25	-	1.0	50	pA
			Full	-	-	500	pA
Extended Common Mode Voltage Range	$V_{CMR}$		+25	+0.6 to -1.1	-	-	V

**Electrical Specifications**  $V_{SUPPLY} = \pm 1V$ ,  $I_Q = 10\mu A$ , Unless Otherwise Specified. (Continued)

PARAMETER	SYMBOL	TEST CONDITIONS	TEMP (°C)	ICL7612B			UNITS
				MIN	TYP	MAX	
Output Voltage Swing	$V_{OUT}$	$R_L = 1M\Omega$	+25	$\pm 0.98$	-	-	V
			Full	$\pm 0.96$	-	-	V
Large Signal Voltage Gain	$A_{VOL}$	$V_O = \pm 0.1V$ , $R_L = 1M\Omega$	+25	-	90	-	dB
			Full	-	80	-	dB
Unity Gain Bandwidth	GBW		+25	-	0.044	-	MHz
Input Resistance	$R_{IN}$		+25	-	$10^{12}$	-	$\Omega$
Common Mode Rejection Ratio	CMRR	$R_S \leq 100k\Omega$	+25	-	80	-	dB
Power Supply Rejection Ratio	PSRR	$R_S \leq 100k\Omega$	+25	-	80	-	dB
Input Referred Noise Voltage	$e_N$	$R_S = 100\Omega$ , $f = 1kHz$	+25	-	100	-	$nV/\sqrt{Hz}$
Input Referred Noise Current	$i_N$	$R_S = 100\Omega$ , $f = 1kHz$	+25	-	0.01	-	$pA/\sqrt{Hz}$
Supply Current	$I_{SUPPLY}$	No Signal, No Load	+25	-	6	15	$\mu A$
Slew Rate	SR	$A_V = 1$ , $C_L = 100pF$ , $V_{IN} = 0.2V_{P-P}$ , $R_L = 1M\Omega$	+25	-	0.016	-	$V/\mu s$
Rise Time	$t_r$	$V_{IN} = 50mV$ , $C_L = 100pF$ , $R_L = 1M\Omega$	+25	-	20	-	$\mu s$
Overshoot Factor	OS	$V_{IN} = 50mV$ , $C_L = 100pF$ , $R_L = 1M\Omega$	+25	-	5	-	%

**Schematic Diagram**

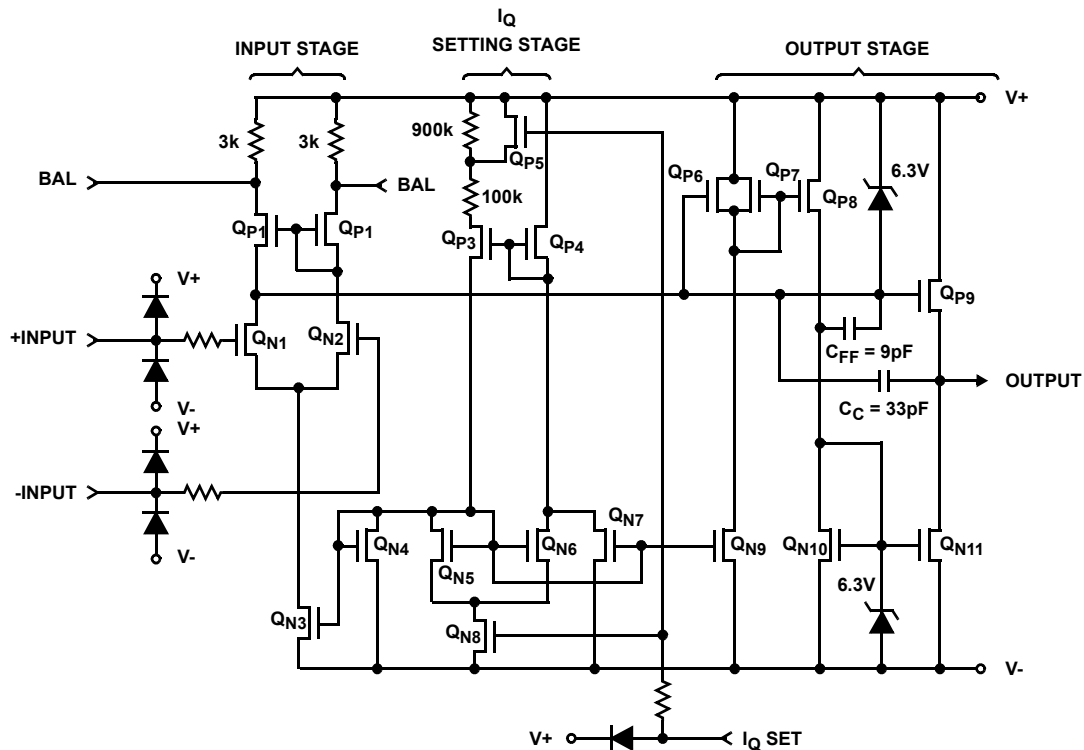

## Application Information

### Static Protection

All devices are static protected by the use of input diodes. However, strong static fields should be avoided, as it is possible for the strong fields to cause degraded diode junction characteristics, which may result in increased input leakage currents.

### Latchup Avoidance

Junction-isolated CMOS circuits employ configurations which produce a parasitic 4-layer (PNPN) structure. The 4-layer structure has characteristics similar to an SCR, and under certain circumstances may be triggered into a low impedance state resulting in excessive supply current. To avoid this condition, no voltage greater than 0.3V beyond the supply rails may be applied to any pin. In general, the op amp supplies must be established simultaneously with, or before any input signals are applied. If this is not possible, the drive circuits must limit input current flow to 2mA to prevent latchup.

### Choosing the Proper $I_Q$

The ICL7611 and ICL7612 have a similar  $I_Q$  set-up scheme, which allows the amplifier to be set to nominal quiescent currents of 10 $\mu$ A, 100 $\mu$ A or 1mA. These current settings change only very slightly over the entire supply voltage range. The ICL7611 and ICL7612 have an external  $I_Q$  control terminal, permitting user selection of quiescent current. To set the  $I_Q$  connect the  $I_Q$  terminal as follows:

$I_Q = 10\mu\text{A}$  -  $I_Q$  pin to  $V+$

$I_Q = 100\mu\text{A}$  -  $I_Q$  pin to ground. If this is not possible, any voltage from  $V+ - 0.8$  to  $V- + 0.8$  can be used.

$I_Q = 1\text{mA}$  -  $I_Q$  pin to  $V-$

NOTE: The output current available is a function of the quiescent current setting. For maximum peak-to-peak output voltage swings into low impedance loads,  $I_Q$  of 1mA should be selected.

### Output Stage and Load Driving Considerations

Each amplifiers' quiescent current flows primarily in the output stage. This is approximately 70% of the  $I_Q$  settings. This allows output swings to almost the supply rails for output loads of 1M $\Omega$ , 100k $\Omega$ , and 10k $\Omega$ , using the output stage in a highly linear class A mode. In this mode, crossover distortion is avoided and the voltage gain is maximized. However, the output stage can also be operated in Class AB for higher output currents. (See graphs under Typical Operating Characteristics). During the transition from Class A to Class B operation, the output transfer characteristic is non-linear and the voltage gain decreases.

### Input Offset Nulling

Offset nulling may be achieved by connecting a 25k pot between the BAL terminals with the wiper connected to  $V+$ . At quiescent currents of 1mA and 100 $\mu$ A the nulling range provided is adequate for all  $V_{OS}$  selections; however with

$I_Q = 10\mu\text{A}$ , nulling may not be possible with higher values of  $V_{OS}$ .

### Frequency Compensation

The ICL7611 and ICL7612 are internally compensated, and are stable for closed loop gains as low as unity with capacitive loads up to 100pF.

### Extended Common Mode Input Range

The ICL7612 incorporates additional processing which allows the input CMVR to exceed each power supply rail by 0.1V for applications where  $V_{SUPPLY} \geq \pm 1.5\text{V}$ . For those applications where  $V_{SUPPLY} \leq \pm 1.5\text{V}$  the input CMVR is limited in the positive direction, but may exceed the negative supply rail by 0.1V in the negative direction (e.g., for  $V_{SUPPLY} = \pm 1\text{V}$ , the input CMVR would be +0.6V to -1.1V).

### Operation At $V_{SUPPLY} = \pm 1\text{V}$

Operation at  $V_{SUPPLY} = \pm 1\text{V}$  is guaranteed at  $I_Q = 10\mu\text{A}$  for A and B grades only.

Output swings to within a few millivolts of the supply rails are achievable for  $R_L \geq 1\text{M}\Omega$ . Guaranteed input CMVR is  $\pm 0.6\text{V}$  minimum and typically +0.9V to -0.7V at  $V_{SUPPLY} = \pm 1\text{V}$ . For applications where greater common mode range is desirable, refer to the description of ICL7612 above.

### Typical Applications

The user is cautioned that, due to extremely high input impedances, care must be exercised in layout, construction, board cleanliness, and supply filtering to avoid hum and noise pickup.

Note that in no case is  $I_Q$  shown. The value of  $I_Q$  must be chosen by the designer with regard to frequency response and power dissipation.

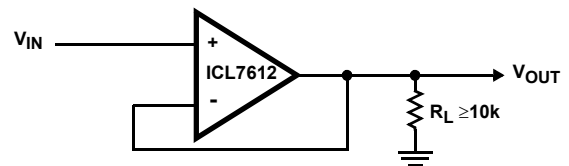
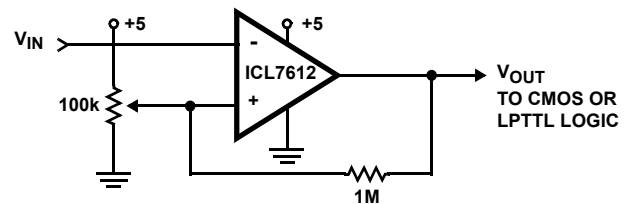

FIGURE 1. SIMPLE FOLLOWER (NOTE 4)



NOTE:

- By using the ICL7612 in this application, the circuit will follow rail to rail inputs.

FIGURE 2. LEVEL DETECTOR (NOTE 4)

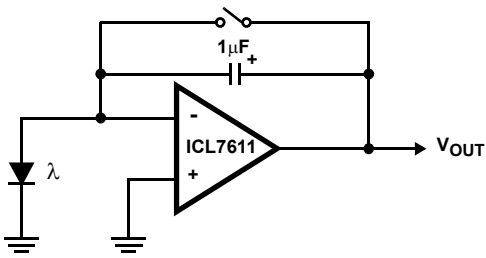

NOTE: Low leakage currents allow integration times up to several hours.

FIGURE 3. PHOTOCURRENT INTEGRATOR

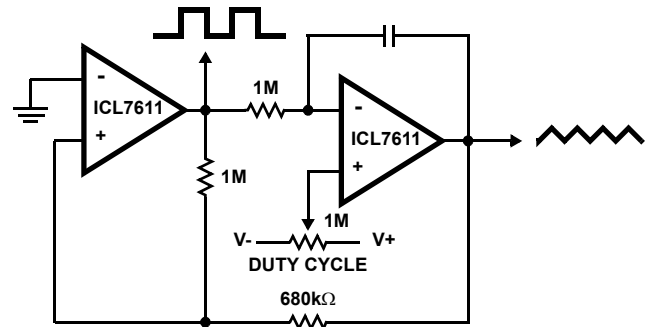

WAVEFORM GENERATOR

NOTE: Since the output range swings exactly from rail to rail, frequency and duty cycle are virtually independent of power supply variations.

FIGURE 4. PRECISE TRIANGLE/SQUARE WAVE GENERATOR

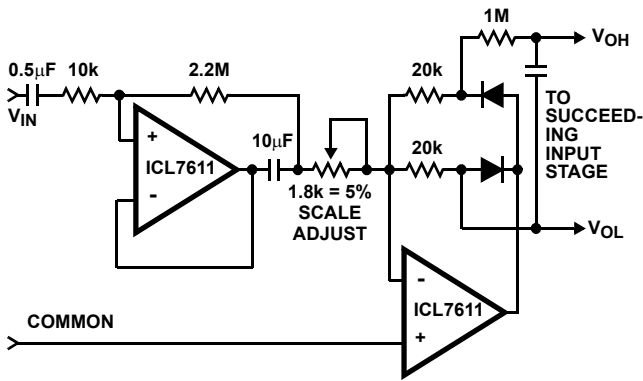

FIGURE 5. AVERAGING AC TO DC CONVERTER FOR A/D CONVERTERS SUCH AS ICL7106, ICL7107, ICL7109, ICL7116, ICL7117

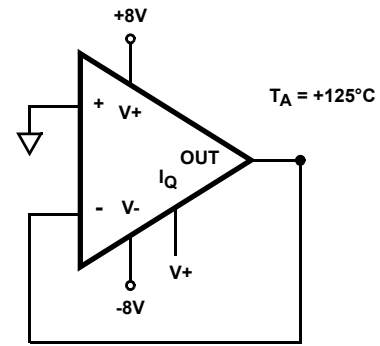

FIGURE 6. BURN-IN AND LIFE TEST CIRCUIT

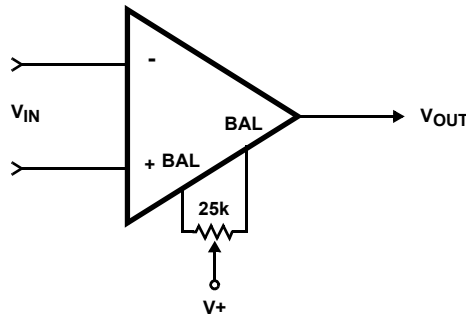
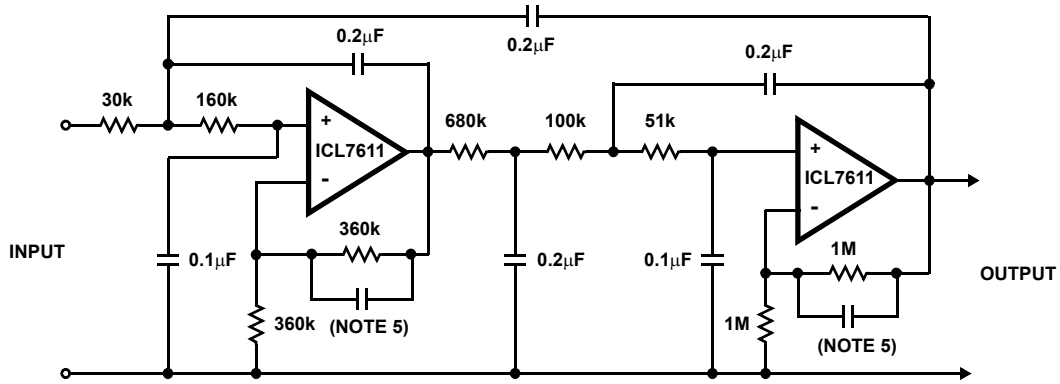

FIGURE 7. VOS NULL CIRCUIT



NOTES:

5. Note that small capacitors (25pF to 50pF) may be needed for stability in some cases.
6. The low bias currents permit high resistance and low capacitance values to be used to achieve low frequency cutoff.  $f_C = 10\text{Hz}$ ,  $A_{VCL} = 4$ , Passband ripple = 0.1dB.

FIGURE 8. FIFTH ORDER CHEBYSHEV MULTIPLE FEEDBACK LOW PASS FILTER

Typical Performance Curves

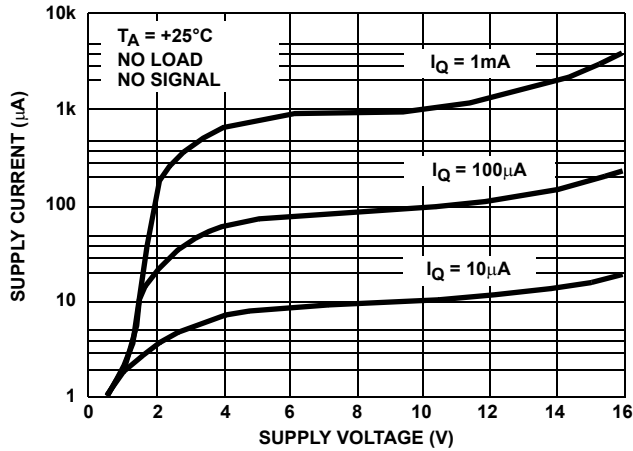

FIGURE 9. SUPPLY CURRENT PER AMPLIFIER vs SUPPLY VOLTAGE

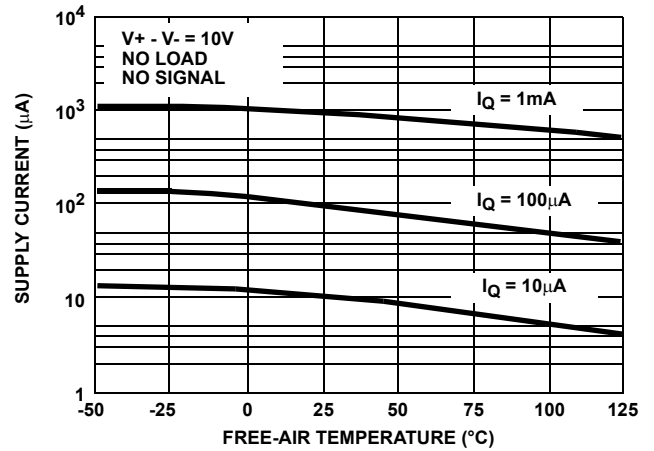

FIGURE 10. SUPPLY CURRENT PER AMPLIFIER vs FREE-AIR TEMPERATURE

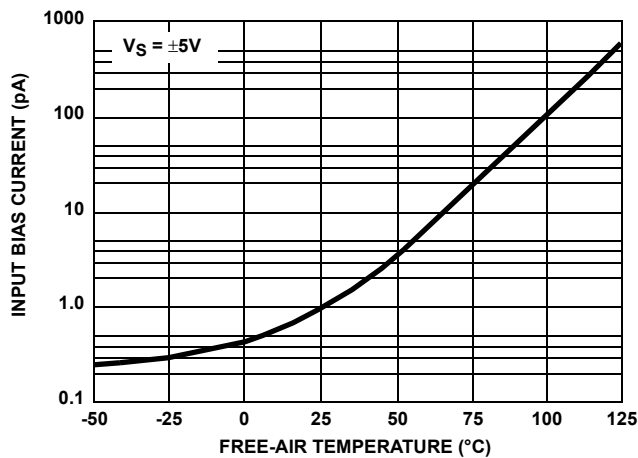

FIGURE 11. INPUT BIAS CURRENT vs TEMPERATURE

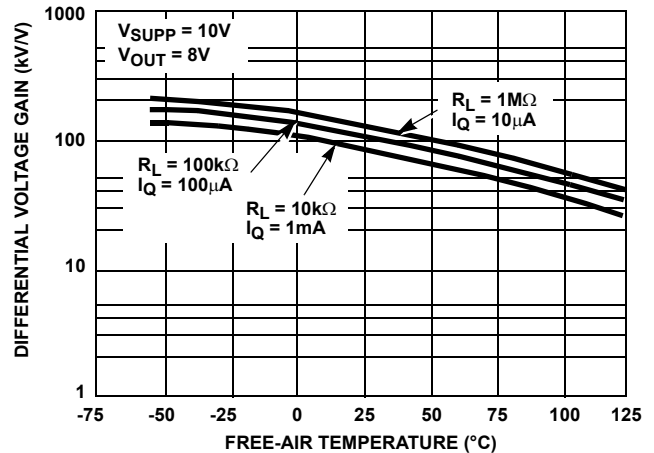

FIGURE 12. LARGE SIGNAL DIFFERENTIAL VOLTAGE GAIN vs FREE-AIR TEMPERATURE



**Typical Performance Curves** (Continued)

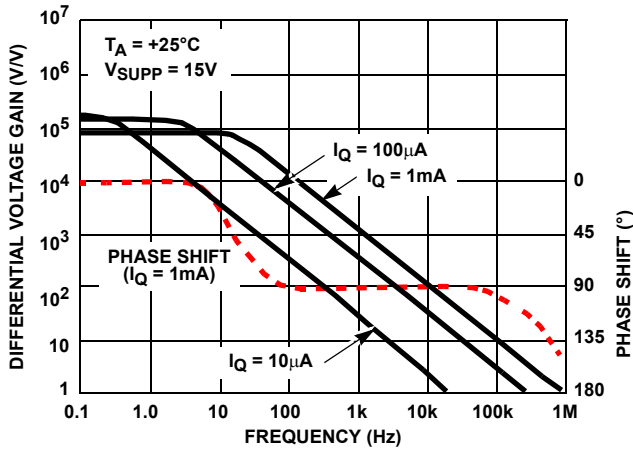

FIGURE 13. LARGE SIGNAL FREQUENCY RESPONSE

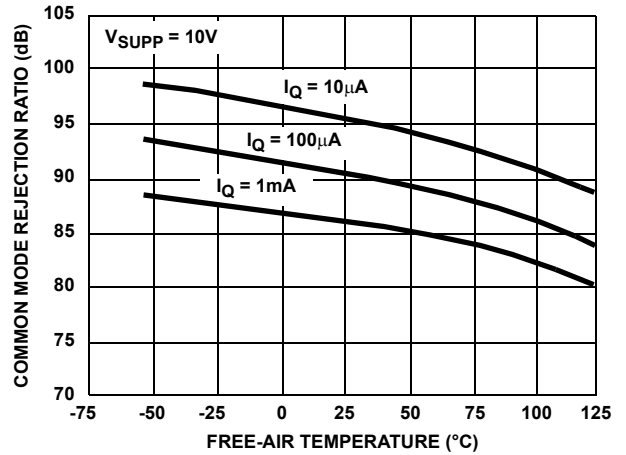

FIGURE 14. COMMON MODE REJECTION RATIO vs FREE-AIR TEMPERATURE

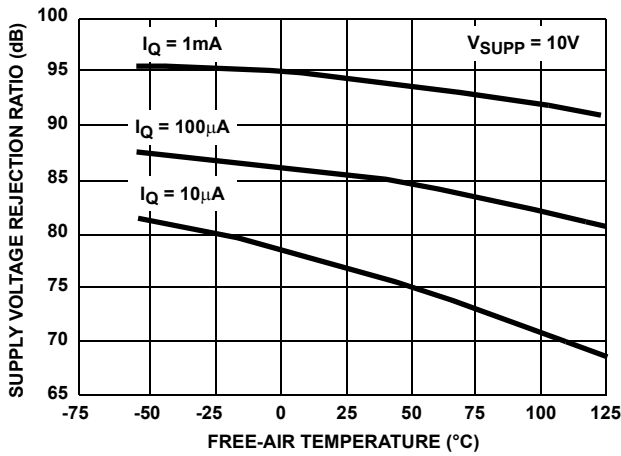

FIGURE 15. POWER SUPPLY REJECTION RATIO vs FREE-AIR TEMPERATURE

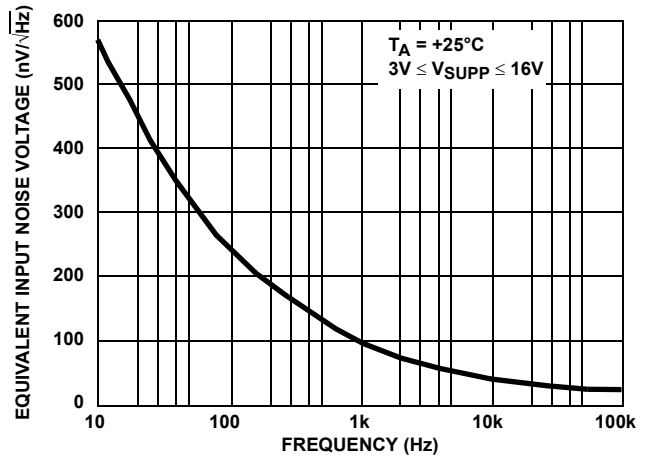

FIGURE 16. EQUIVALENT INPUT NOISE VOLTAGE vs FREQUENCY

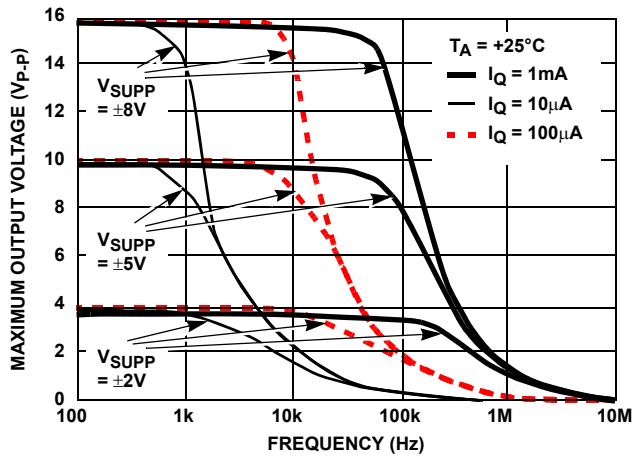

FIGURE 17. OUTPUT VOLTAGE vs FREQUENCY

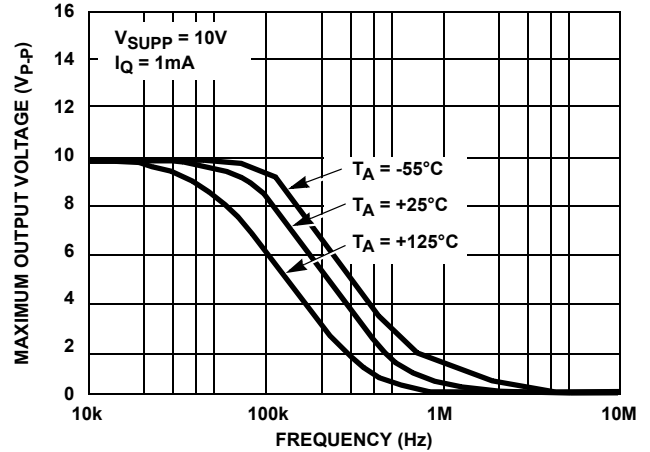

FIGURE 18. OUTPUT VOLTAGE vs FREQUENCY

**Typical Performance Curves** (Continued)

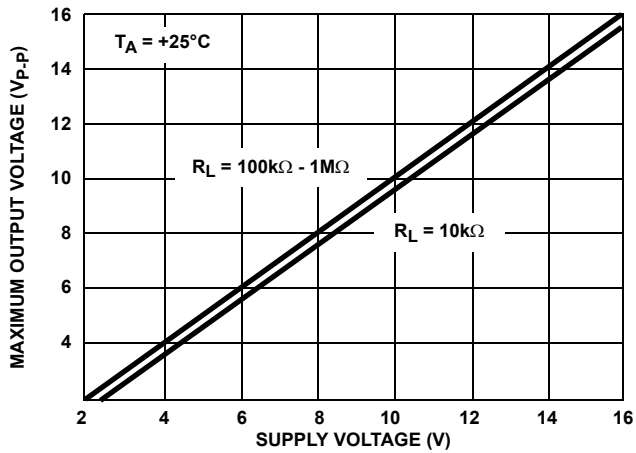

FIGURE 19. OUTPUT VOLTAGE vs SUPPLY VOLTAGE

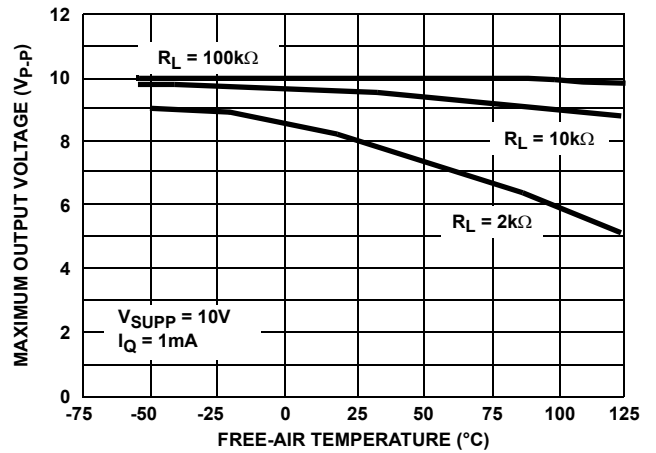

FIGURE 20. OUTPUT VOLTAGE vs FREE-AIR TEMPERATURE

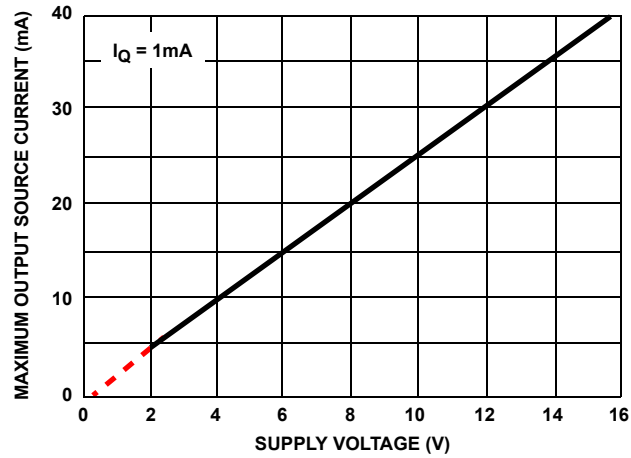

FIGURE 21. OUTPUT SOURCE CURRENT vs SUPPLY VOLTAGE

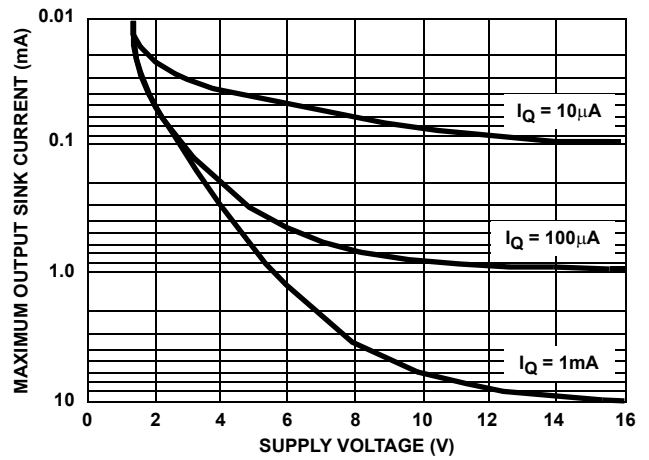

FIGURE 22. OUTPUT SINK CURRENT vs SUPPLY VOLTAGE

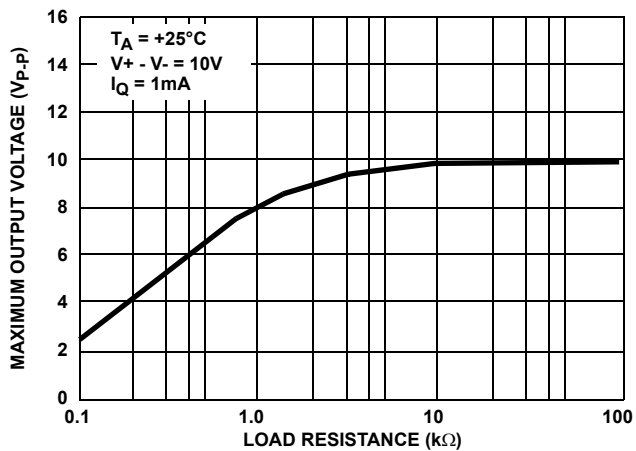

FIGURE 23. OUTPUT VOLTAGE vs LOAD RESISTANCE

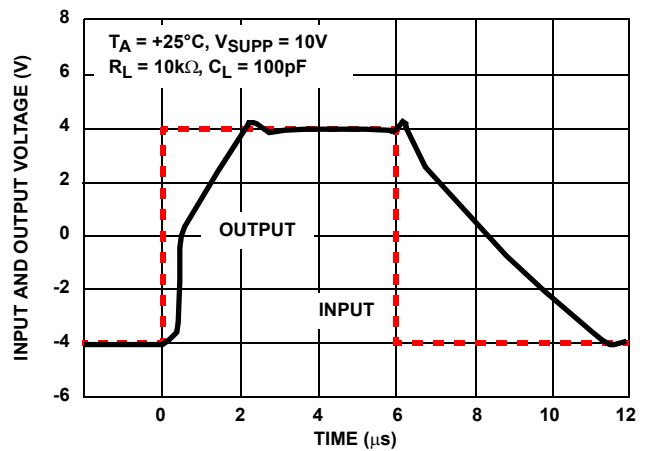
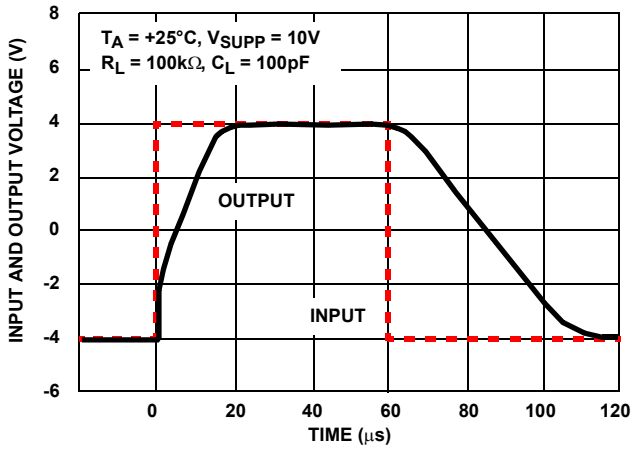
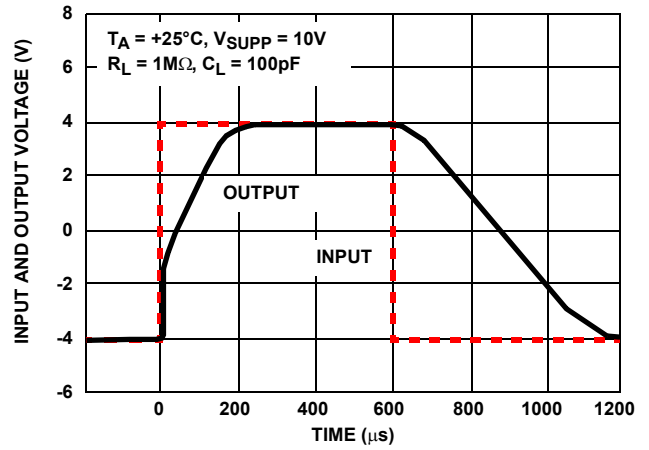

FIGURE 24. VOLTAGE FOLLOWER LARGE SIGNAL PULSE RESPONSE ( $I_Q = 1\text{mA}$ )

**Typical Performance Curves** (Continued)

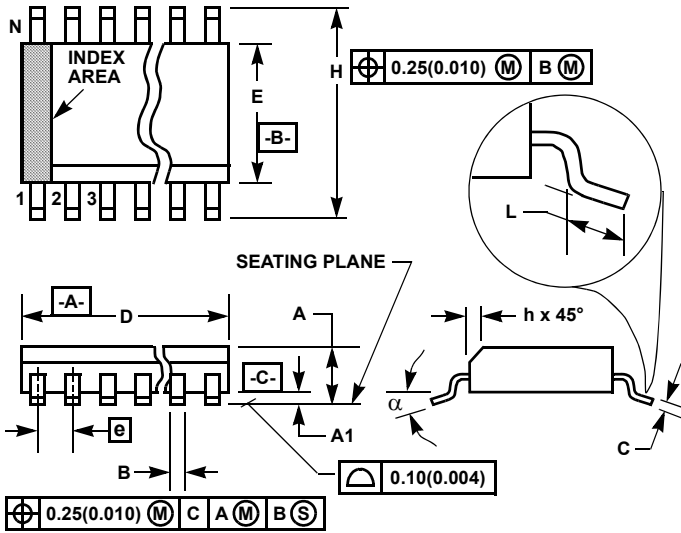

**FIGURE 25. VOLTAGE FOLLOWER LARGE SIGNAL PULSE RESPONSE ( $I_Q = 100\mu\text{A}$ )**



**FIGURE 26. VOLTAGE FOLLOWER LARGE SIGNAL PULSE RESPONSE ( $I_Q = 10\mu\text{A}$ )**

**Small Outline Plastic Packages (SOIC)**



**M8.15 (JEDEC MS-012-AA ISSUE C)  
8 LEAD NARROW BODY SMALL OUTLINE PLASTIC PACKAGE**

SYMBOL	INCHES		MILLIMETERS		NOTES
	MIN	MAX	MIN	MAX	
A	0.0532	0.0688	1.35	1.75	-
A1	0.0040	0.0098	0.10	0.25	-
B	0.013	0.020	0.33	0.51	9
C	0.0075	0.0098	0.19	0.25	-
D	0.1890	0.1968	4.80	5.00	3
E	0.1497	0.1574	3.80	4.00	4
e	0.050 BSC		1.27 BSC		-
H	0.2284	0.2440	5.80	6.20	-
h	0.0099	0.0196	0.25	0.50	5
L	0.016	0.050	0.40	1.27	6
N	8		8		7
α	0°	8°	0°	8°	-

**NOTES:**

1. Symbols are defined in the "MO Series Symbol List" in Section 2.2 of Publication Number 95.
2. Dimensioning and tolerancing per ANSI Y14.5M-1982.
3. Dimension "D" does not include mold flash, protrusions or gate burrs. Mold flash, protrusion and gate burrs shall not exceed 0.15mm (0.006 inch) per side.
4. Dimension "E" does not include interlead flash or protrusions. Interlead flash and protrusions shall not exceed 0.25mm (0.010 inch) per side.
5. The chamfer on the body is optional. If it is not present, a visual index feature must be located within the crosshatched area.
6. "L" is the length of terminal for soldering to a substrate.
7. "N" is the number of terminal positions.
8. Terminal numbers are shown for reference only.
9. The lead width "B", as measured 0.36mm (0.014 inch) or greater above the seating plane, shall not exceed a maximum value of 0.61mm (0.024 inch).
10. Controlling dimension: MILLIMETER. Converted inch dimensions are not necessarily exact.

Rev. 1 6/05

## Dual-In-Line Plastic Packages (PDIP)

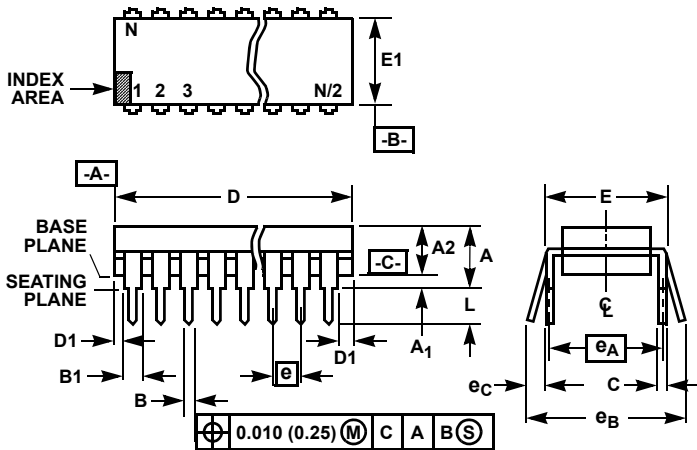

**NOTES:**

- Controlling Dimensions: INCH. In case of conflict between English and Metric dimensions, the inch dimensions control.
- Dimensioning and tolerancing per ANSI Y14.5M-1982.
- Symbols are defined in the "MO Series Symbol List" in Section 2.2 of Publication No. 95.
- Dimensions A, A1 and L are measured with the package seated in JEDEC seating plane gauge GS-3.
- D, D1, and E1 dimensions do not include mold flash or protrusions. Mold flash or protrusions shall not exceed 0.010 inch (0.25mm).
- E and e<sub>A</sub> are measured with the leads constrained to be perpendicular to datum -C-.
- e<sub>B</sub> and e<sub>C</sub> are measured at the lead tips with the leads unconstrained. e<sub>C</sub> must be zero or greater.
- B1 maximum dimensions do not include dambar protrusions. Dambar protrusions shall not exceed 0.010 inch (0.25mm).
- N is the maximum number of terminal positions.
- Corner leads (1, N, N/2 and N/2 + 1) for E8.3, E16.3, E18.3, E28.3, E42.6 will have a B1 dimension of 0.030 - 0.045 inch (0.76 - 1.14mm).

### E8.3 (JEDEC MS-001-BA ISSUE D) 8 LEAD DUAL-IN-LINE PLASTIC PACKAGE

SYMBOL	INCHES		MILLIMETERS		NOTES
	MIN	MAX	MIN	MAX	
A	-	0.210	-	5.33	4
A1	0.015	-	0.39	-	4
A2	0.115	0.195	2.93	4.95	-
B	0.014	0.022	0.356	0.558	-
B1	0.045	0.070	1.15	1.77	8, 10
C	0.008	0.014	0.204	0.355	-
D	0.355	0.400	9.01	10.16	5
D1	0.005	-	0.13	-	5
E	0.300	0.325	7.62	8.25	6
E1	0.240	0.280	6.10	7.11	5
e	0.100 BSC		2.54 BSC		-
e <sub>A</sub>	0.300 BSC		7.62 BSC		6
e <sub>B</sub>	-	0.430	-	10.92	7
L	0.115	0.150	2.93	3.81	4
N	8		8		9

Rev. 0 12/93

© Copyright Intersil Americas LLC 2004-2007. All Rights Reserved.  
All trademarks and registered trademarks are the property of their respective owners.

For additional products, see [www.intersil.com/en/products.html](http://www.intersil.com/en/products.html)

Intersil products are manufactured, assembled and tested utilizing ISO9001 quality systems as noted in the quality certifications found at [www.intersil.com/en/support/qualandreliability.html](http://www.intersil.com/en/support/qualandreliability.html)

Intersil products are sold by description only. Intersil may modify the circuit design and/or specifications of products at any time without notice, provided that such modification does not, in Intersil's sole judgment, affect the form, fit or function of the product. Accordingly, the reader is cautioned to verify that datasheets are current before placing orders. Information furnished by Intersil is believed to be accurate and reliable. However, no responsibility is assumed by Intersil or its subsidiaries for its use; nor for any infringements of patents or other rights of third parties which may result from its use. No license is granted by implication or otherwise under any patent or patent rights of Intersil or its subsidiaries.

For information regarding Intersil Corporation and its products, see [www.intersil.com](http://www.intersil.com)