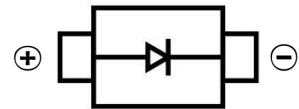

GENERAL PURPOSE RECTIFIER DIODE
FEATURES

- Glass Passivated Die Construction
- Low reverse leakage current
- Low forward voltage drop
- High current capability
- Surface Mount device

SMA

MECHANICAL DATA

- Case: SMA(DO-214AC)
- Case Material: Molded Plastic. UL flammability
- Classification Rating: 94V-0
- Weight: 0.065 grams (approximate)

MAXIMUM RATINGS AND CHARACTERISTICS(T_A = 25°C unless otherwise noted)

Parameter	Symbol	S2A	S2B	S2D	S2G	S2J	S2K	S2M	Unit
Maximum Recurrent Peak Reverse Voltage	V _{RRM}	50	100	200	400	600	800	1000	V
DC Blocking Reverse Voltage	V _R	50	100	200	400	600	800	1000	V
RMS Reverse Voltage	V _{R(RMS)}	35	70	140	280	420	560	700	V
Maximum Average Forward Rectified Current	I _F	2							A
Non-Repetitive Peak Forward Surge Current @t=8.3ms	I _{FSM}	60							A
Thermal Resistance From Junction To Ambient	R _{θJA}	75							°C/W
Reverse Recovery Time (@I _F =0.5A, I _R =1.0A, I _{RR} =0.25A)	t _{rr}	2							uS
Operating and Storage Temperature	T _J , T _{STG}	-55 ~+150							°C

ELECTRICAL CHARACTERISTICS (T_A = 25°C unless otherwise specified)

Parameter	Symbol	Min	Typ	Max	Unit	Conditions
Forward voltage	V _F			1.1	V	I _F =2A
Reverse current	I _R			5	μA	V=V _R
				50		
Junction capacitance	C _J		30		pF	V _R =4V, f=1MHz

GENERAL PURPOSE RECTIFIER DIODE

Typical Characteristics

Fig.1 Forward Current Derating Curve

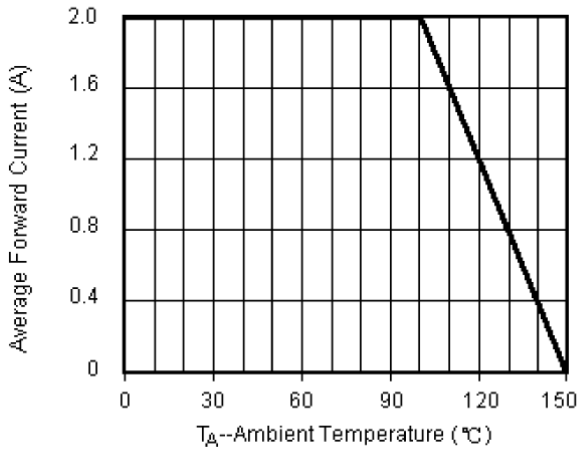

Fig.2 Maximum Non-Repetitive Peak Forward Surge Current

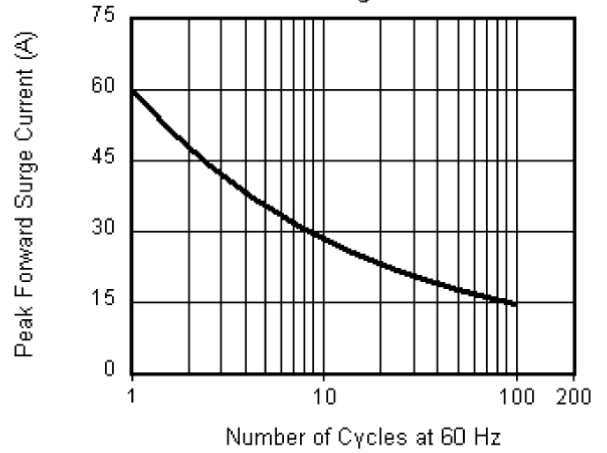

Fig.3 Typical Instantaneous Forward Characteristics

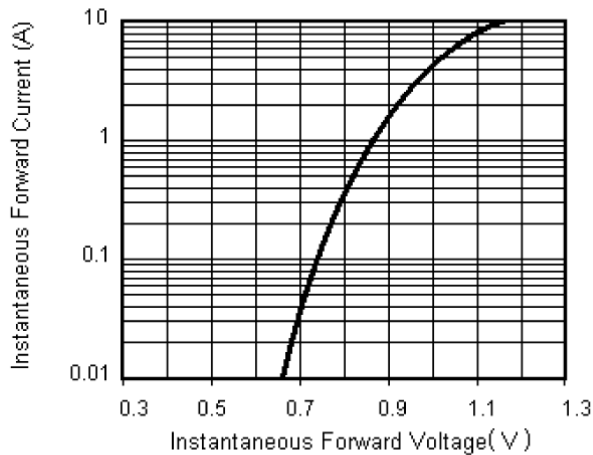

Fig.4 Typical Reverse Leakage Characteristics

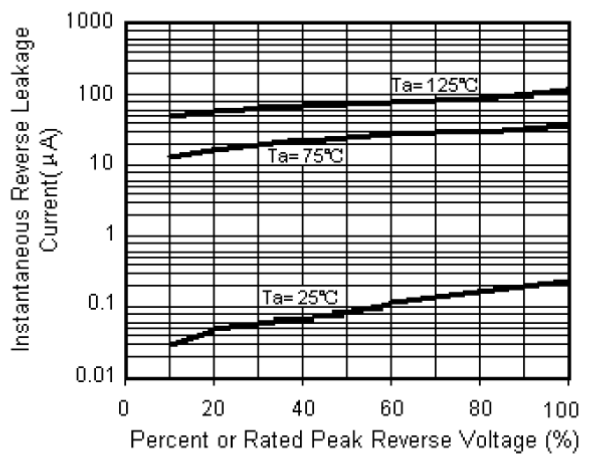

Fig.5 Typical Junction Capacitance

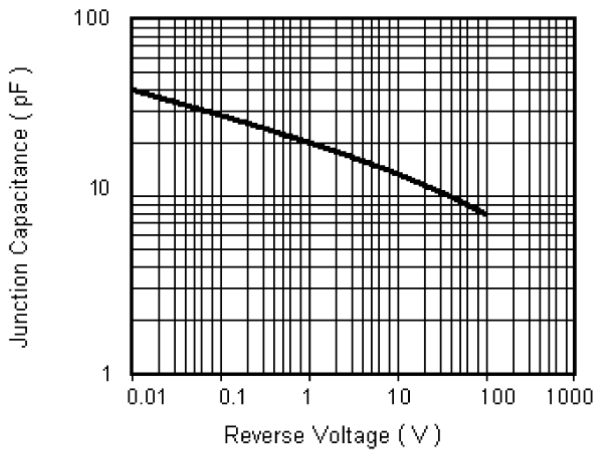
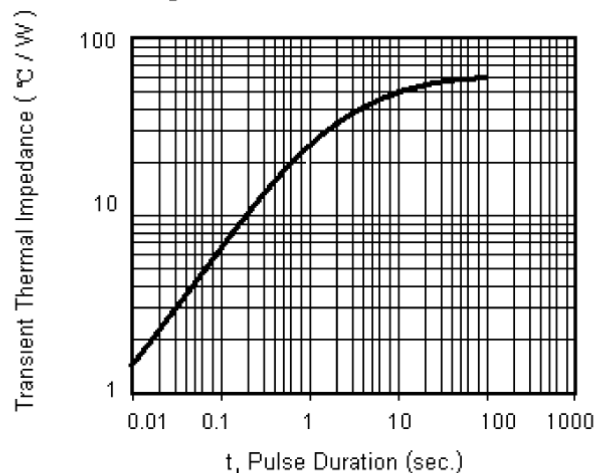
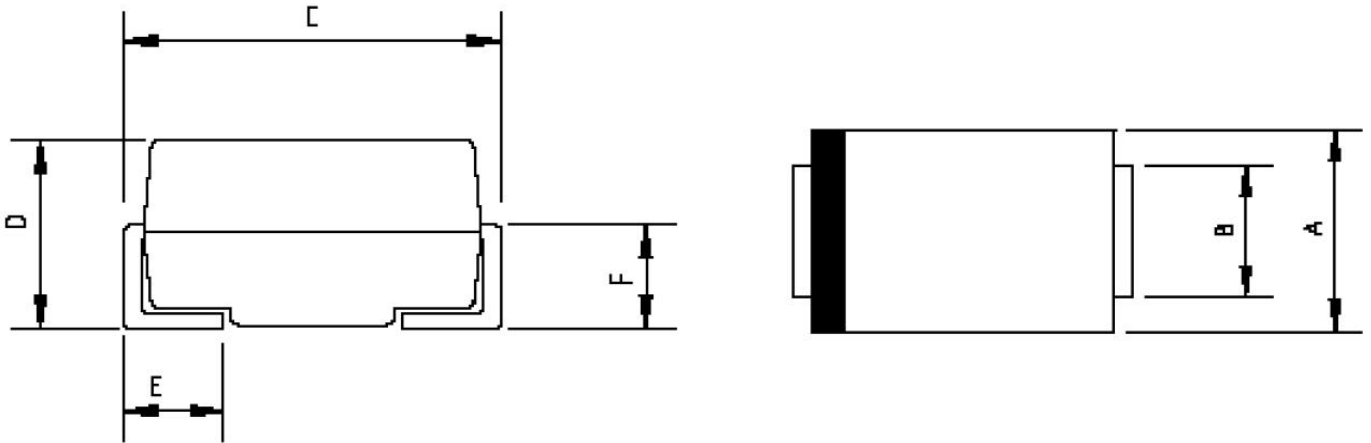

Fig.6 Transient Thermal Impedance



GENERAL PURPOSE RECTIFIER DIODE

SMA Package Outline Dimensions



Symbol	Dimensions In Millimeters		Dimensions In Inches	
	Min.	Max.	Min.	Max.
A	2.20	2.80	0.086	0.110
B	1.30	1.70	0.051	0.067
C	4.70	5.30	0.185	0.209
D	1.70	2.55	0.067	0.100
E	0.90	1.50	0.035	0.059
F	0.90	1.50	0.035	0.059

SMA Suggested Pad Layout

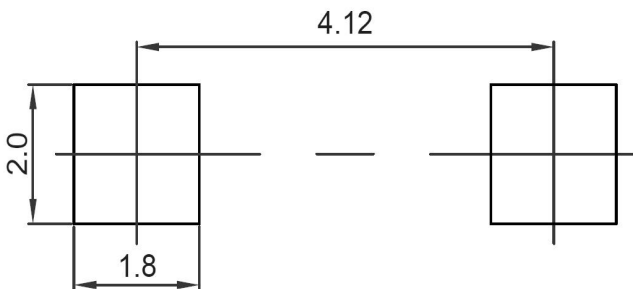

Note:

1. Controlling dimension: in millimeters
2. General tolerance: $\pm 0.05\text{mm}$
3. The pad layout is for reference purposes only

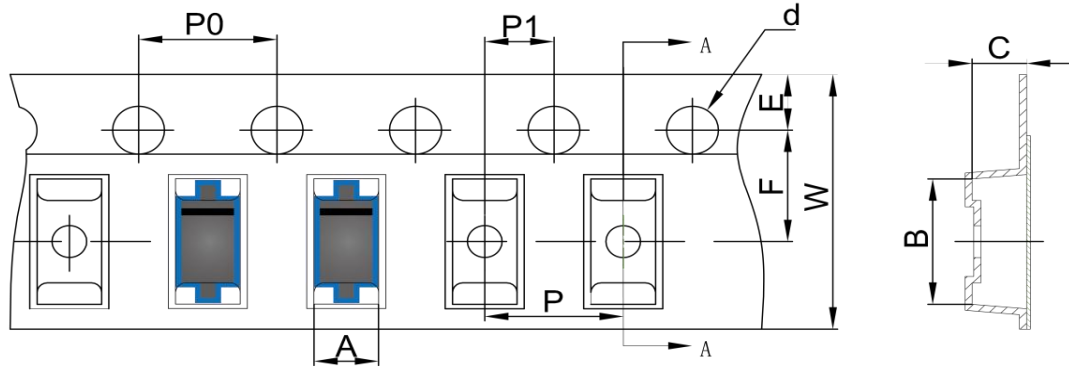
GENERAL PURPOSE RECTIFIER DIODE
SMA Tape and Reel
SMA Embossed Carrier Tape

DIMENSIONS ARE IN MILLIMETER										
TYPE	A	B	C	d	E	F	P0	P	P1	W
SMA	2.89	5.35	2.68	Ø1.50	1.75	5.50	4.00	4.00	2.00	12.00
TOLERANCE	±0.1	±0.1	±0.1	±0.1	±0.1	±0.1	±0.1	±0.1	±0.1	±0.1

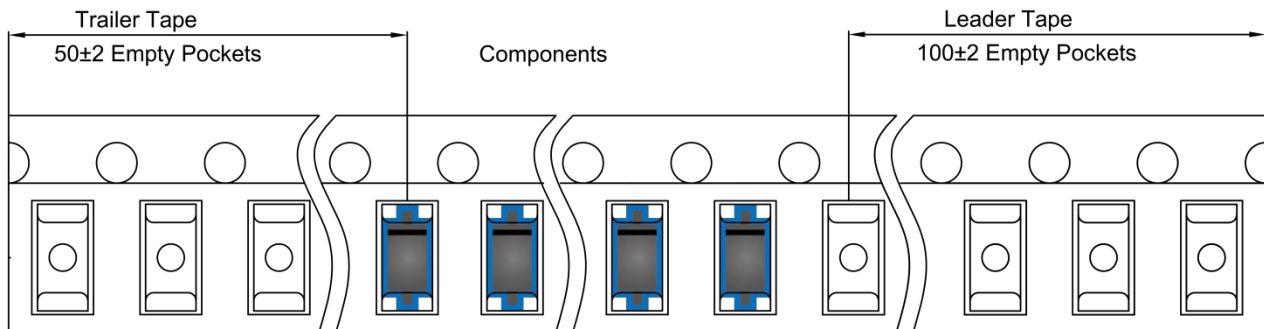
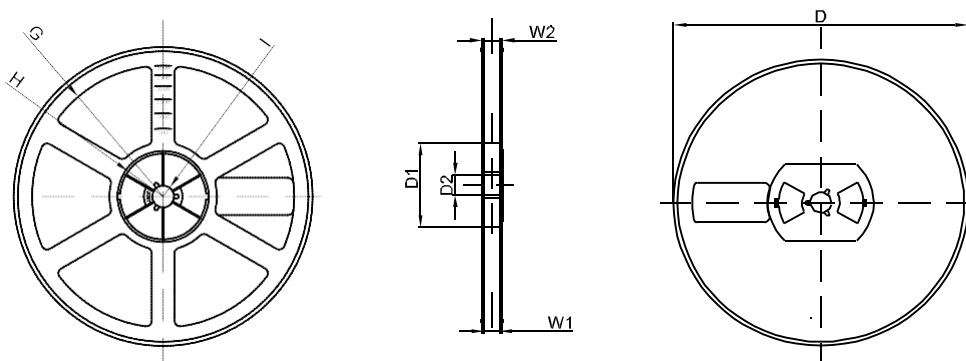
SMA Tape Leader and Trailer

SMA Reel

DIMENSIONS ARE IN MILLIMETER								
REEL OPTION	D	D1	D2	G	H	I	W1	W2
7" DIA	Ø178	54.40	13.00	R78	R25.60	R6.50	12.40	17.60
TOLERANCE	±2	±1	±1	±1	±1	±1	±1	±1