

MC21605G6W-SPTLY3.3-V2	2 x 16	5mm Character Height	LCD Module
Specification			
Version: 1		Date: 12/03/2021	
Revision			
1	10/03/2021	First Issue	

Display Features		
Character Count	2 x 16	
Appearance	Black on Yellow/Green	
Logic Voltage	3.3V	
Interface	Parallel	
Font Set	English / Japanese	
Display Mode	Transflective	
Character Height	5.23mm	
LC Type	STN	
Module Size	80.00 x 36.00 x 13.50 mm	
Operating Temperature	-20°C ~ +70°C	
Construction	COB	Box Quantity
LED Backlight	Yellow/Green	Weight / Display



RoHS
compliant

* - For full design functionality, please use this specification in conjunction with the ST7066U + ST7065C specification. (Provided Separately)

Display Accessories	
Part Number	Description
MCCMDB-16SIL	LCD Interconnect board, can be driven from either a PC or a single Board computer with a USB output.
MCCBL1A16SLIP-16DILS-150	16 Way, Single in-line to Dual In-line connector Cable.
MCCBL1A16SLIP-16SILS-150	16 Way, Single in-line to Single In-line connector Cable.

Optional Variants		
Fonts	Appearances	Voltage
English/Euro English/Cyrillic	White on Blue Black on White Black on RGB	3V 5V



FEATURES

AVAILABLE OPTIONS	CHARACTERISTICS
a f p m i ^ v = d o j ^ q	16 Characters by 2 Lines
m l i ^ o f w b o = l m q f l k p	Positive Transflective
_ ^ ` h i f d e q = q v m b = l m q f l k p	Edge Type LED Backlight (Long life span version)
_ ^ ` h i f d e q = ` l i l o = l m q f l k p	Yellow-Green color
i ` a = m ^ k b i = l m q f l k p	Yellow-Green STN
s f b t f k d = ^ k d i b = l m q f l k p	6:00 (Bottom)
q b j m b o ^ q r o b = o ^ k d b = l m q f l k p	-20°C ~ 70°C, Single Supply Voltage
p r d d b p q b a = a o f s f k d = s l i q ^ d b	V _{icm} = 3.3V V _{led} = 3.3V
p r d d b p q b a = i b a = a o f s f k d = j l a b	PIN15: LED+, PIN16: LED-
` l k q o l i i b o	ST7066U+ST7065C
c l k q = j ^ m ` l a b	E Version
a o f s f k d = a r q v	1/16
a o f s f k d = _ f ^ p	1/5

MECHANICAL SPECIFICATIONS

OVERALL SIZE	80.0W x 36.0H	mm	THICKNESS	max 13.5	mm
VIEWING AREA	64.5W x 16.4H	mm	HOLE-HOLE	75.0W x 31.0H	mm
CHARACTER SIZE	3.00W x 5.23H	mm	CHARACTER PITCH	0.51W x 0.52H	mm
DOT SIZE	0.56W x 0.61H	mm	DOT PITCH	0.05W x 0.05H	mm

ABSOLUTE MAXIMUM RATINGS

ITEM	SYMBOL	CONDITION	MIN	TYP	MAX	UNIT
m l t b o = p r m m i v = E # i d f ` F	s ÇÇ	OR [±]	-0.3	—	7.0	V
m l t b o = p r m m i v = E ` a F	s M	OR [±]	V _{dd} -13.5	—	V _{dd} +0.3	V
f k m r q = s l i q ^ d b	s ää	OR [±]	-0.3	—	V _{dd} +0.3	V
l m b o ^ q f k d = q b j m b o ^ q r o b	s ç éé	—	-20	—	70	°C
p q l o ^ d b = q b j m b o ^ q r o b	s ëíÖ	—	-30	—	80	°C

ELECTRONIC CHARACTERISTICS

ITEM	SYMBOL	CONDITION	MIN	TYP	MAX	UNIT
f k m r q = s l i q ^ d b	s ÇÇ	—	—	3.3	—	V
p r m m i v = ` r o o b k q	f ÇÇ	V _{dd} =3.3V	—	1.5	—	mA
a o f s f k d = s l i q ^ d b c l o = i ` a = m ^ k b i	s äÇÇ=EsÇÇ=MF	-20°C	—	—	—	V
		0°C	—	—	—	
		25°C	—	—	—	
		50°C	—	—	—	
		70°C	—	—	—	

LCD CHARACTERISTICS

FOR STN/FSTN TYPE LCD Panel (TA=25 °C, Vlcd=5.0V ± 0.5V)

	ITEM	SYMBOL	CONDITION	MIN	TYP	MAX	UNIT
	Viewing angle	Φ_2	K=4	40	—	—	deg
		θ		60			
	Contrast ratio	K	—	6	—	—	—
	Response time (white to black)	T _o	—	—	150	250	ms
	Response time (black to white)	T _c	—	—	150	250	ms

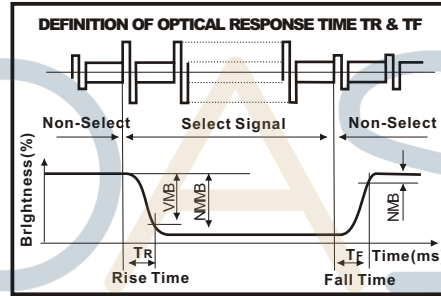
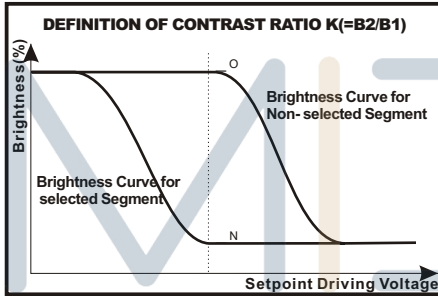
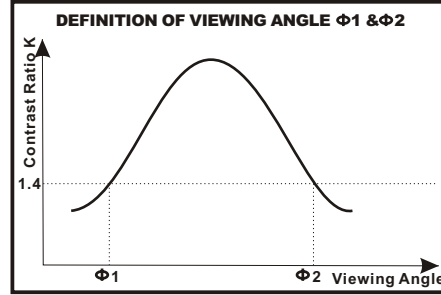
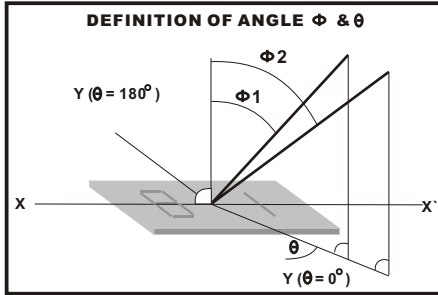

LED CHARACTERISTICS

	ITEM	SYMBOL	CONDITION	MIN	TYP	MAX	UNIT
	Forward voltage	V _f	25 °C I _f = 5mA	—	3.0	—	V
	Forward current	I _f	25 °C	—	5	—	mA
	Reverse current	I _r	25 °C V _r = 5V	—	—	10	μA
	Wavelength	λ _e	25 °C I _f = 5mA	569	—	575	nm
	Luminance	I _v	25 °C I _f = 5mA	—	125	—	cd/m ²
	Viewing angle	—	25 °C I _f = 5mA	70	—	—	Ratio
	Life time	—	25 °C I _f = 5mA	20K	—	—	Hours



PIN ASSIGNMENT

PIN	SYMBOL	DESCRIPTION	REMARKS
1	Vss	GND	
2	Vdd	Power supply for LCM	3.3V
3	NC	No connection	
4	RS	Register Select Signal	
5	R/W	Data Read / Write	
6	E	Enable Signal	
7	DB0	Data bus line	
8	DB1	Data bus line	
9	DB2	Data bus line	
10	DB3	Data bus line	
11	DB4	Data bus line	
12	DB5	Data bus line	
13	DB6	Data bus line	
14	DB7	Data bus line	
15	LED+	Power supply for BKL	3.3V
16	LED-	Power supply for BKL	

BLOCK DIAGRAM

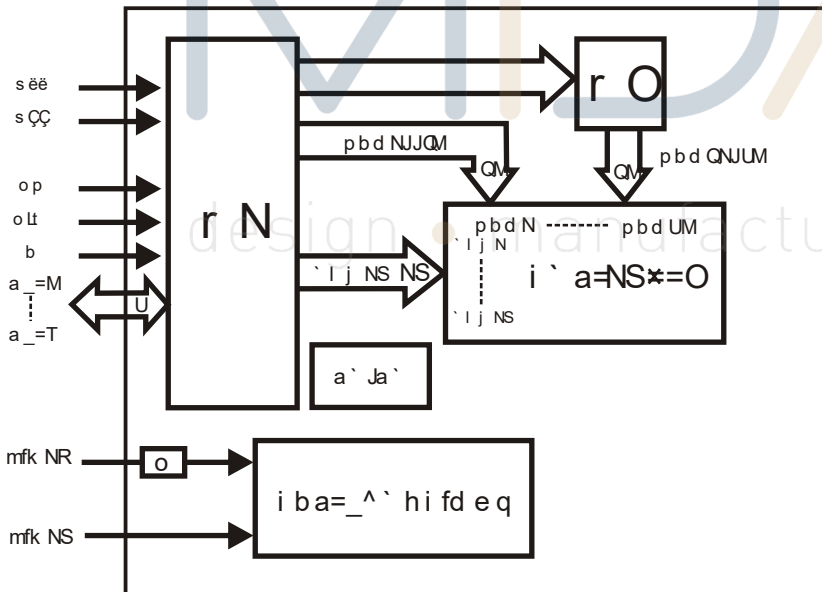

POWER SUPPLY DIAGRAM

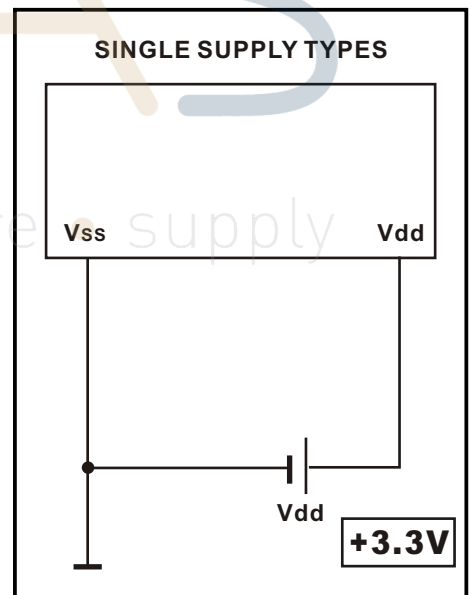

$r \text{ éé } \text{Éé}$ $i \text{ çí } \text{Éé}$ $Q\check{A}\check{A}$	$iiii$	$iiie$	$iiiei$	$iiiee$	$ieiii$	$ieiee$	$ieeii$	$ieeee$	$eiii$	$eiiee$	$eieii$	$eieee$	$eeiii$	$eeiee$	$eeeei$	$eeee$
iii ^d $o^{\wedge}j$ ENF																
$iiie$ EOF																
$iiiei$ EPF																
$iiiee$ EOF																
$ieiii$ ERF																
$ieiee$ ESF																
$ieeii$ ETF																
$ieeee$ EUF																
$eiii$ ENF																
$eiiee$ EOF																
$eieii$ EPF																
$eieee$ EOF																
$eeiii$ ERF																
$eeiee$ ESF																
$eeeei$ ETF																
$eeee$ EUF																



