

MC21605G6W-FPTLW3.3-V2	2 x 16	5mm Character Height	LCD Module
Specification			
Version: 1		Date: 12/03/2021	
Revision			
1	10/03/2021	First Issue	

Display Features		
Character Count	2 x 16	
Appearance	Black on White	
Logic Voltage	3.3V	
Interface	Parallel	
Font Set	English / Japanese	
Display Mode	Transflective	
Character Height	5.23mm	
LC Type	FSTN	
Module Size	80.00 x 36.00 x 13.50 mm	
Operating Temperature	-20°C ~ +70°C	
Construction	COB	Box Quantity
LED Backlight	White	---
		Weight / Display



RoHS
compliant

* - For full design functionality, please use this specification in conjunction with the ST7066U + ST7065C specification. (Provided Separately)

Display Accessories	
Part Number	Description
MCCMDB-16SIL	LCD Interconnect board, can be driven from either a PC or a single Board computer with a USB output.
MCCBL1A16SLIP-16DILS-150	16 Way, Single in-line to Dual In-line connector Cable.
MCCBL1A16SLIP-16SILS-150	16 Way, Single in-line to Single In-line connector Cable.

Optional Variants		
Fonts	Appearances	Voltage
English/Euro English/Cyrillic	Black on Yellow/ Green White on Blue Black on RGB	3V 5V



FEATURES

AVAILABLE OPTIONS	CHARACTERISTICS
a f p m i ^ v = d o j ^ q	16 Characters by 2 Lines
m l i ^ o f w b o = l m q f l k p	Positive Transflective
_ ^ ` h i f d e q = q m b = l m q f l k p	Edge Type LED Backlight (Long life span version)
_ ^ ` h i f d e q = l i l o = l m q f l k p	White color
i ` a = m ^ k b i = l m q f l k p	FSTN
s f b t f k d = ^ k d i b = l m q f l k p	6:00 (Bottom)
q b j m b o ^ q r o b = o ^ k d b = l m q f l k p	-20°C ~ 70°C, Single Supply Voltage
p r d d b p q b a = a o f s f k d = s l i q ^ d b	V _{lcm} = 3.3V V _{led} = 3.3V
p r d d b p q b a = i b a = a o f s f k d = j l a b	PIN15: LED+, PIN16: LED-
` l k q o l i i b o	ST7066U + ST7065C
c l k q = j ^ n = ` l a b	E Version
a o f s f k d = a r q v	1/16
a o f s f k d = _ f ^ p	1/5

MECHANICAL SPECIFICATIONS

OVERALL SIZE	80.0W x 36.0H	mm	THICKNESS	max 13.5	mm
VIEWING AREA	64.5W x 16.4H	mm	HOLE-HOLE	75.0W x 31.0H	mm
CHARACTER SIZE	3.00W x 5.23H	mm	CHARACTER PITCH	0.51W x 0.52H	mm
DOT SIZE	0.56W x 0.61H	mm	DOT PITCH	0.05W x 0.05H	mm

ABSOLUTE MAXIMUM RATINGS

ITEM	SYMBOL	CONDITION	MIN	TYP	MAX	UNIT
m l t b o = p r m m i v = E # i d f ^ F	s ÇÇ	OR ^o =`	-0.3	—	7.0	V
m l t b o = p r m m i v = E ` a F	s M	OR ^o =`	V _{dd} -13.5	—	V _{dd} +0.3	V
f k m r q = s l i q ^ d b	s ää	OR ^o =`	-0.3	—	V _{dd} +0.3	V
l m b o ^ q f k d = q b j m b o ^ q r o b	s ç éê	—	-20	—	70	°C
p q l o ^ d b = q b j m b o ^ q r o b	s ëíÖ	—	-30	—	80	°C

ELECTRONIC CHARACTERISTICS *

ITEM	SYMBOL	CONDITION	MIN	TYP	MAX	UNIT
f k m r q = s l i q ^ d b	s ÇÇ	—	—	3.3	—	V
p r m m i v = ` r o o b k q	f ÇÇ	V _{dd} =3.3V	—	1.5	—	mA
a o f s f k d = s l i q ^ d b c l o = i ` a = m ^ k b i	s ä Ä Ç = E s ÇÇ = MF	-20°C	—	—	—	V
		0°C	—	—	—	
		25°C	—	—	—	
		50°C	—	—	—	
		70°C	—	—	—	

LCD CHARACTERISTICS

FOR STN/FSTN TYPE LCD Panel (TA=25 °C, Vlcd=5.0V ± 0.5V)

	ITEM	SYMBOL	CONDITION	MIN	TYP	MAX	UNIT
	sfbt fkd=^k di b	$\Phi_2 \text{ } \Phi_1$	K=4	40	—	—	deg
		θ		60			
	l k qo ^pq= o^ qfl	K	—	6	—	—	—
	o b pml k p b= qfj b E f p b F	To	—	—	150	250	ms
	o b pml k p b= qfj b E ^ i i F	Tc	—	—	150	250	ms

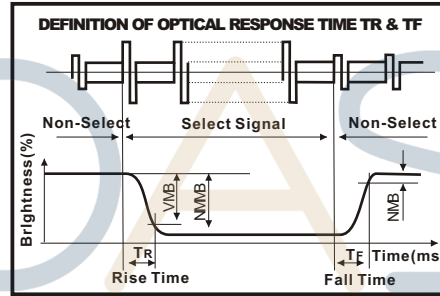
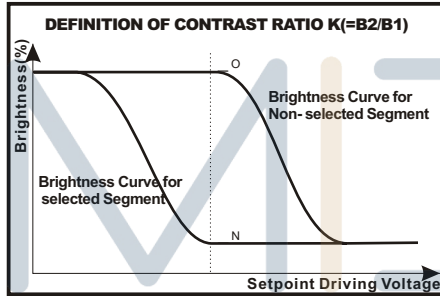
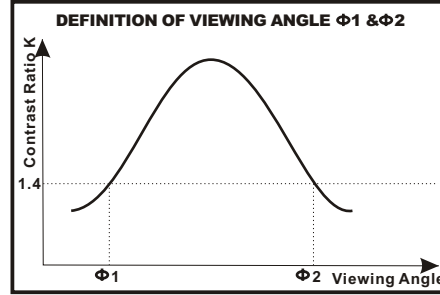
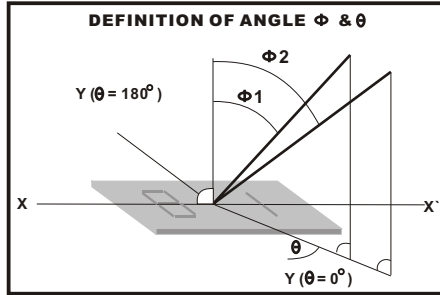

LED CHARACTERISTICS

	ITEM	SYMBOL	CONDITION	MIN	TYP	MAX	UNIT
	i ba=cl ot ^oa=sl i q^ db	s Ñ	25 °C If =15mA	—	3.0	—	V
	i ba=cl ot ^oa= `r o obkq	f Ñ	25 °C	—	15	—	mA
	i ba=obsbopb= `r o obkq	f ê	25 °C Vr=5.0V	—	—	30	µA
	i ba= `l i l o o^ k d b	$u = \frac{A_{\text{c}} \cdot C_{\text{a}}}{A_{\text{c}} \cdot C_{\text{a}} - I_{\text{E}}}$	25 °C If =15mA	0.26	—	0.30	—
		$v = \frac{A_{\text{c}} \cdot C_{\text{a}}}{A_{\text{c}} \cdot C_{\text{a}} - I_{\text{E}}}$		0.27	—	0.31	—
	i ba= _ofdeqk b p p= f q e l r q ð ` a F	i î	25 °C If = 15mA	—	310	—	cd/m ²
	i ba= _ofdeqk b p p= k f c l o j f q v	i î ã ä ü î ã ~ ñ	25 °C If =15mA	70	—	—	Ratio
	i ba= i f c b= qfj b	—	25 °C If = 15mA	20K	—	—	Hours



PIN ASSIGNMENT

PIN	SYMBOL	DESCRIPTION	REMARKS
1	Vss	GND	
2	Vdd	Power supply for LCM	3.3V
3	NC	No connection	
4	RS	Register Select Signal	
5	R/W	Data Read / Write	
6	E	Enable Signal	
7	DB0	Data bus line	
8	DB1	Data bus line	
9	DB2	Data bus line	
10	DB3	Data bus line	
11	DB4	Data bus line	
12	DB5	Data bus line	
13	DB6	Data bus line	
14	DB7	Data bus line	
15	LED+	Power supply for BKL	3.3V
16	LED-	Power supply for BKL	

BLOCK DIAGRAM

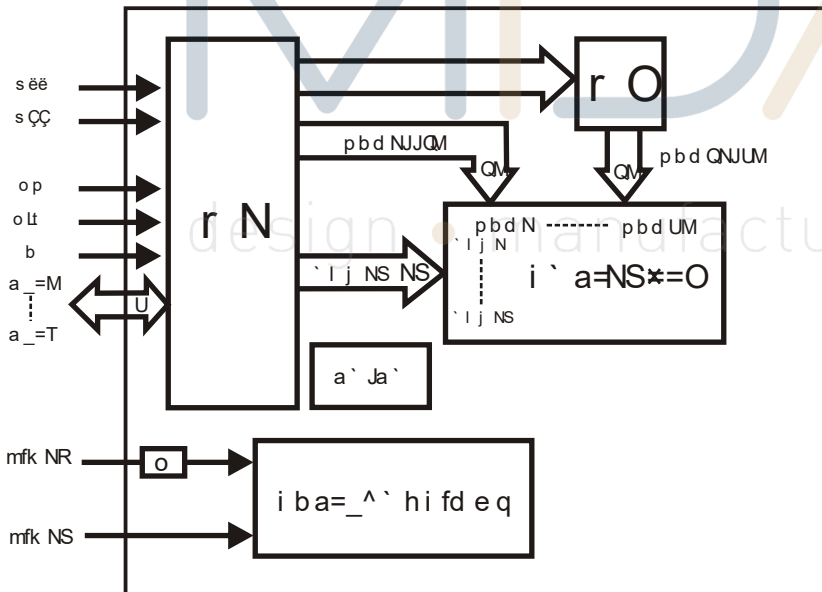

POWER SUPPLY DIAGRAM

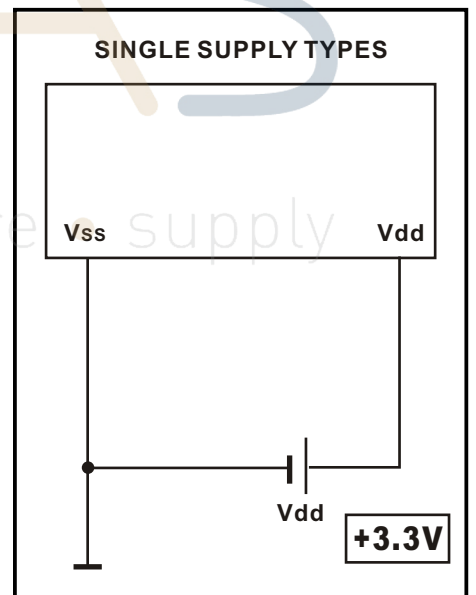

$\begin{matrix} r & \acute{e} & \acute{e} & \acute{e} & \acute{e} \\ i & \grave{c} & \acute{i} & \acute{e} & \acute{e} \\ \acute{Q} & \acute{A} & \acute{A} & & \end{matrix}$	$\begin{matrix} \acute{e} & \acute{e} & \acute{e} & \acute{e} & \acute{e} \\ \acute{Q} & \acute{A} & \acute{A} & & \end{matrix}$	iiii	iiie	iiiei	iiiee	ieiii	ieiee	ieeie	ieeee	eiiii	eiiee	eieie	eieee	eeiii	eeiee	eeeee
iiii	$\begin{matrix} \acute{d} \\ o \wedge j \\ ENF \end{matrix}$															
iiie	EOF															
iiiei	EPF															
iiiee	EOF															
ieiii	ERF															
ieiee	ESF															
ieeie	ETF															
ieeee	EUF															
eiii	ENF															
eiiee	EOF															
eieie	EPF															
eieee	EOF															
eeiii	ERF															
eeiee	ESF															
eeiei	ETF															
eeeee	EUF															



