

4G/LTE Ceramic Chip Antenna



ACAR3705-S698



37.0 x 5.0 x 5.0 mm
RoHS/RoHS II Compliant
MSL = NA

Features

- 4G/LTE full band coverage (700~960 MHz, 1710~2170 MHz, 2500~2700MHz)
- 2G/3G/GSM support
- Compact size
- Linear polarization

Applications

- IoT
- M2M
- 4G/LTE/3G/2G/GSM applications
- Telecommunications
- Networking
- Wireless modules
- Mobile devices
- Consumer electronics
- Broadband cellular connectivity
- Video and surveillance

Electrical Characteristics

Item	Spec*	Comments
Working Frequency Range	700~960 MHz / 1710~2170 MHz / & 2500~2700 MHz	Covers 4G LTE
VSWR	4.5 : 1 max	Depends on the environment
Peak Gain (2400~2500MHz)	-3.77dB min / -1.13dB max	Frequency dependent measured from 824MHz to 2700MHz
Efficiency	700~960 MHz	55%
	1710~ 2170MHz	70%
	2500~2700MHz	50%
Polarization	Linear	
Impedance	50 Ω	
Terminations	Ag	Environmentally Friendly Pb Free
Operating Temperature	-40°C ~ 85°C	
Storage Temperature	-40°C ~ 85°C	

* Data collected per Table on standard evaluation board size 45 x 107 mm, and under the environmental conditions of +40°C and 0-95% relative humidity.

** Actual Electrical value will depend on customer ground plane size

4G/LTE Ceramic Chip Antenna



ACAR3705-S698



37.0 x 5.0 x 5.0 mm
RoHS/RoHS II Compliant
MSL = NA

Dimensions

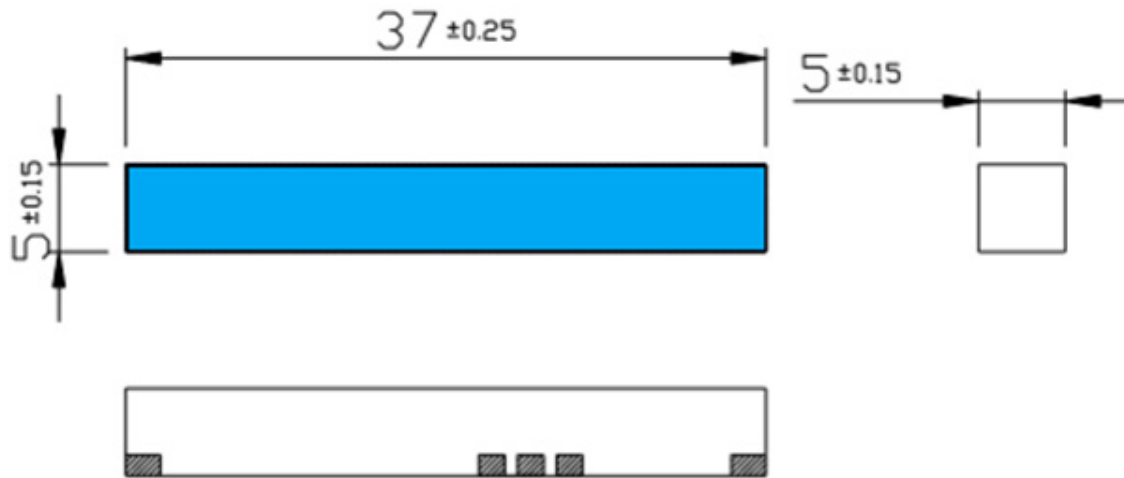

Unit:mm

Evaluation Board and Dimensions

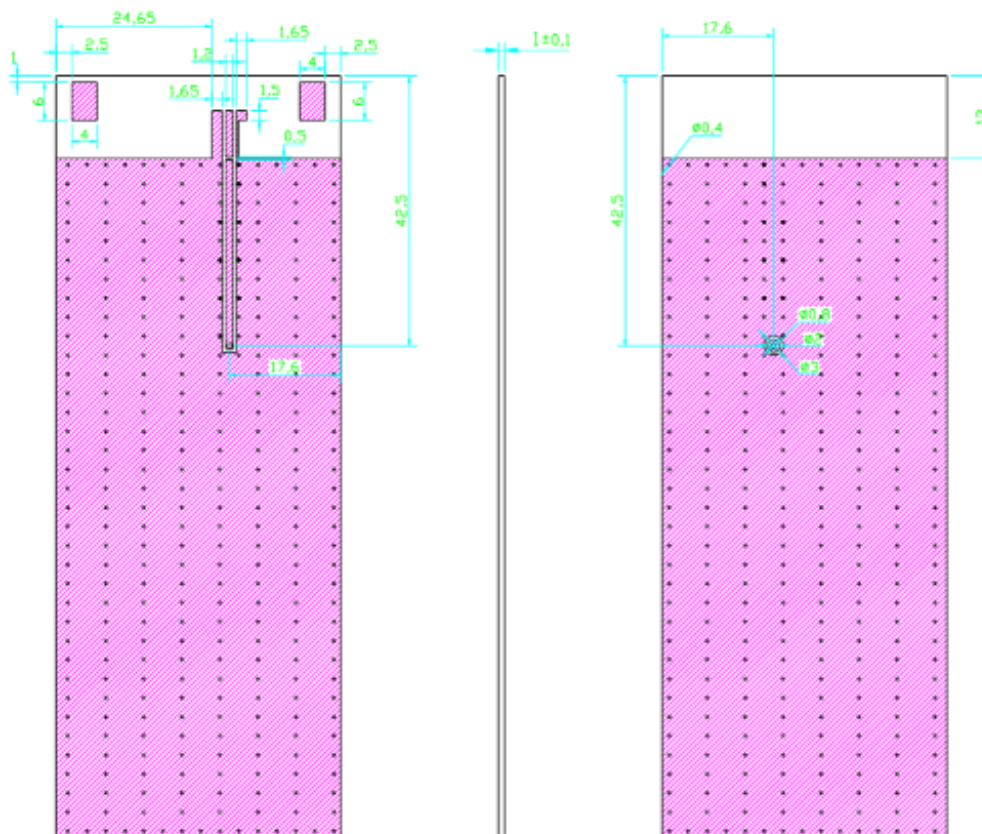

4G/LTE Ceramic Chip Antenna



ACAR3705-S698



37.0 x 5.0 x 5.0 mm
RoHS/RoHS II Compliant
MSL = NA

Recommended Layout Dimensions

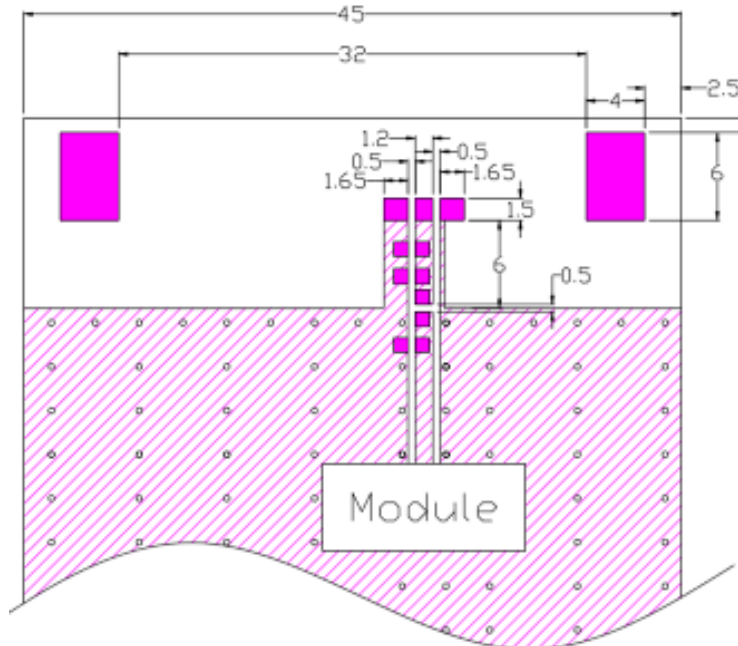

Recommended Layout from Evaluation Board

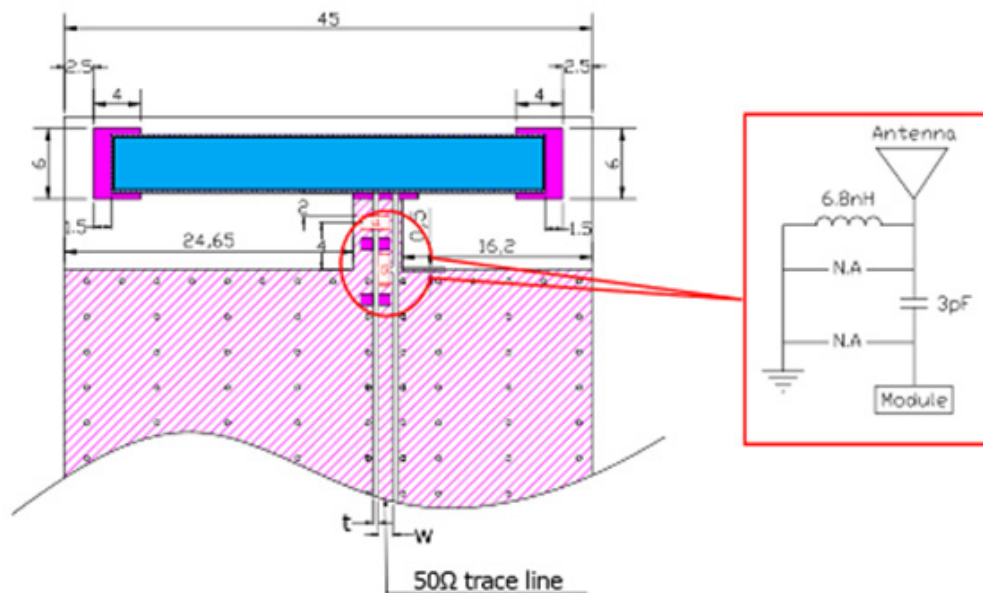

T and w = Unique dimensioning according to your PCB design.

4G/LTE Ceramic Chip Antenna



ACAR3705-S698



37.0 x 5.0 x 5.0 mm
RoHS/RoHS II Compliant
MSL = NA

Evaluation Board showing position of match components and solder pads

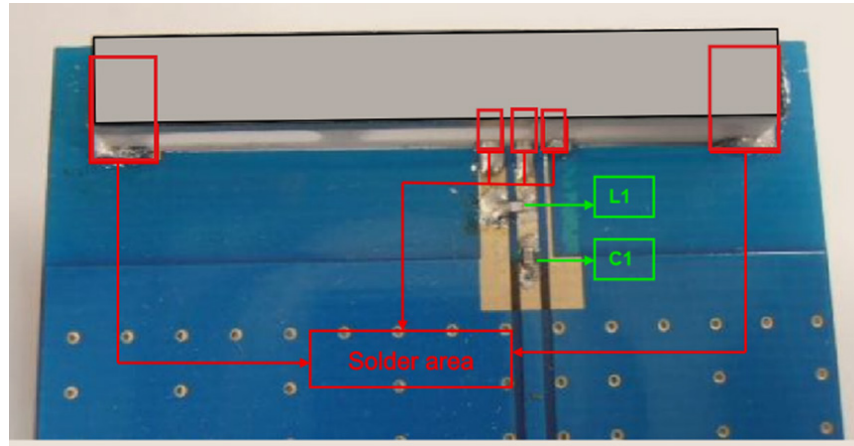

Circuit Symbol	Size	Description
L1	0402	6.8nH
C1	0402	3pF Capacitor

Antenna Response – Return Loss S11

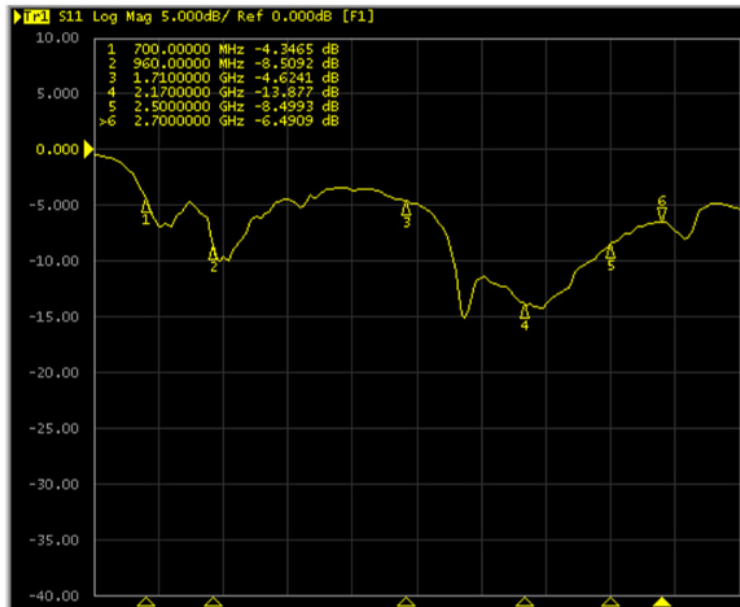

Return Loss	700MHz	960MHz	1710MHz	2170MHz	2500MHz	2700MHz
S11	-4.34dB	-8.50dB	-4.62dB	-13.87dB	-8.49dB	-6.49dB

4G/LTE Ceramic Chip Antenna



ACAR3705-S698



37.0 x 5.0 x 5.0 mm
RoHS/RoHS II Compliant
MSL = NA

Antenna SWR

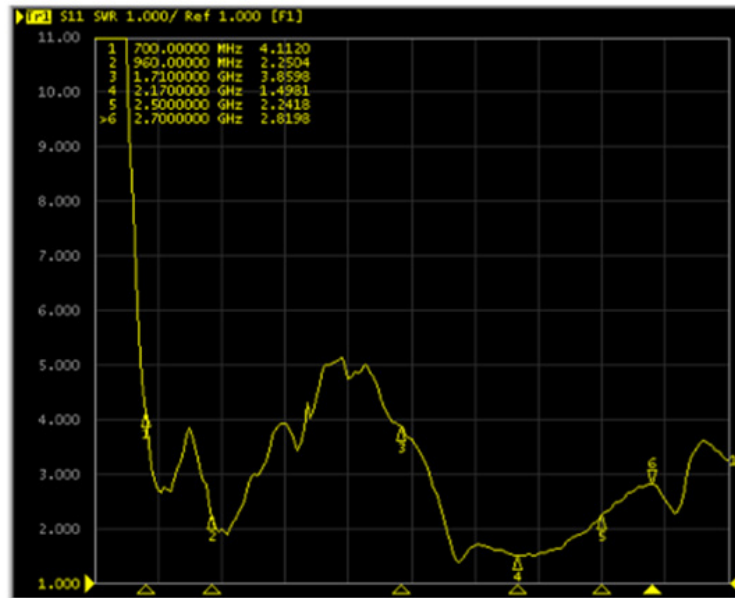

Antenna Smith Chart

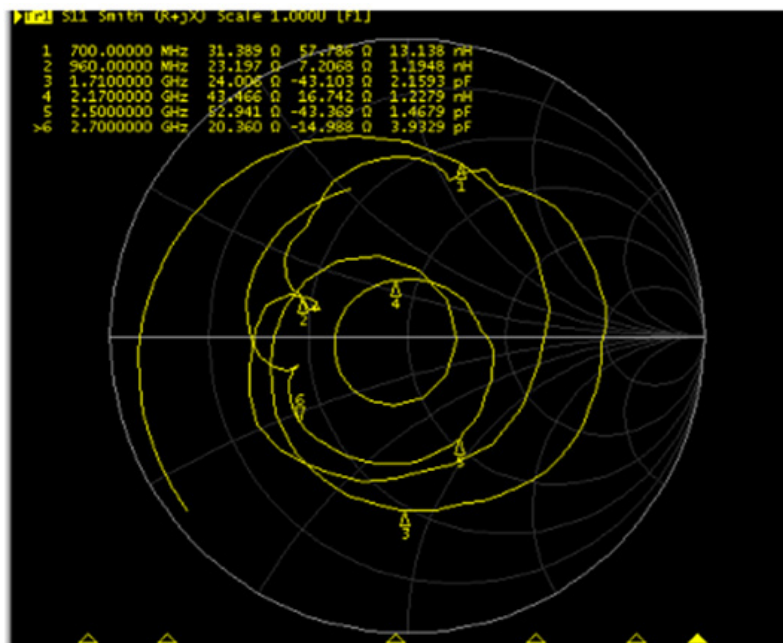

4G/LTE Ceramic Chip Antenna



ACAR3705-S698



37.0 x 5.0 x 5.0 mm
RoHS/RoHS II Compliant
MSL = NA

Antenna Performance

GSM Antenna Performance Summary*								
Band (MHz)	824	960	1710	1850	1990	2170	2500	2700
Efficiency (%)	54.50	51.26	45.07	57.30	67.94	77.00	56.66	41.99
Average Gain (dBi)	-2.47	-2.49	-3.46	-2.42	-1.67	-1.13	-2.46	-3.77

* (Ground Length 107 mm)

Antenna Efficiency Versus Ground Plane Length

Reference Efficiency vs Ground Plane Length

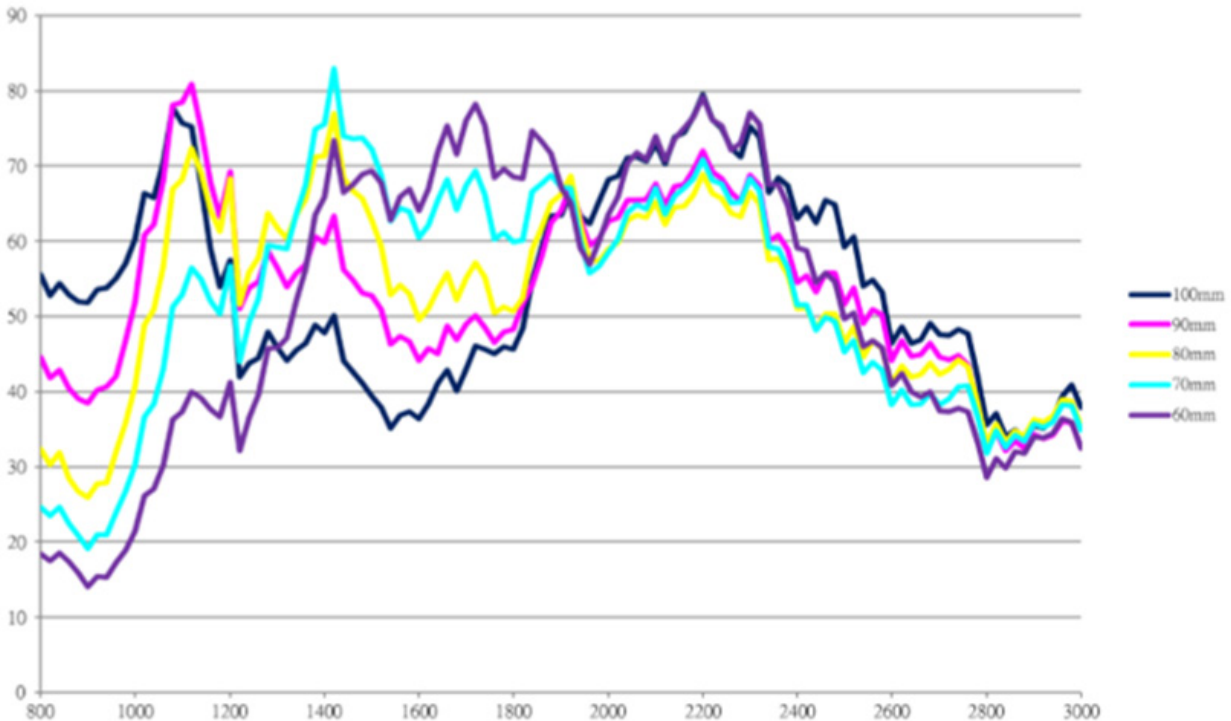

4G/LTE Ceramic Chip Antenna



ACAR3705-S698



37.0 x 5.0 x 5.0 mm
RoHS/RoHS II Compliant
MSL = NA

Antenna 3D Radiation Patterns – Evaluation Board

Coordinates

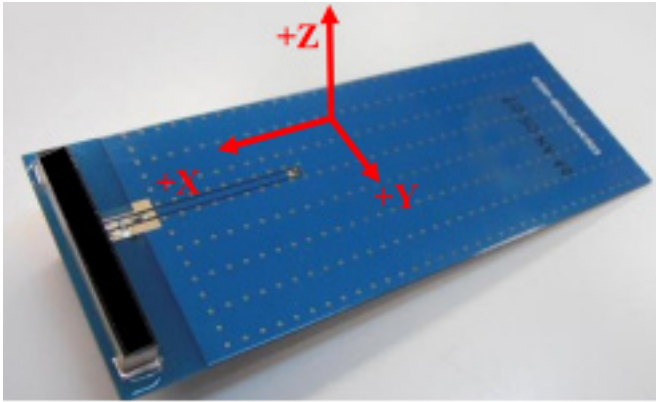

Radiation patterns (3D)

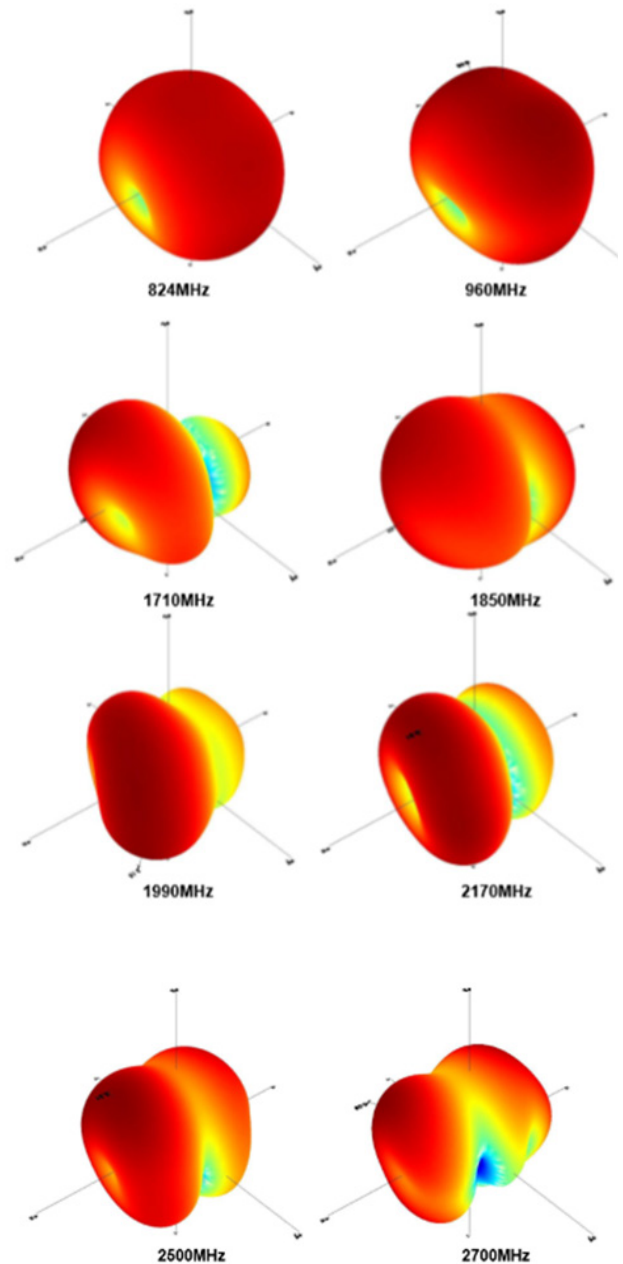

4G/LTE Ceramic Chip Antenna



ACAR3705-S698



37.0 x 5.0 x 5.0 mm
RoHS/RoHS II Compliant
MSL = NA

Reflow Soldering Standard Condition

Abrakon's ACAR3705-S698 Planer Inverted-F antenna can be assembled following either Sn-Pb or Pb-free assembly. According to the Standard IPC/JEDEC J-STD-020C, the temperature profile suggested is as follow:

Phase	Profile Features	Sn-Pb Assembly	Pb-Free Assembly (SnAgCu)
Ramp-Up	Avg Ramp-Up Rate (T _{max} to TP)	3°C /second(max)	3°C /second(max)
Preheat	-Temperature Min (T _{min}) -Temperature Max (T _{max}) -Time (T _{min} to T _{max})	100°C 150°C 60-120 seconds	100°C 150°C 60-120 seconds
Reflow	-Temperature (TL) -Total Time above TL (t L)	183°C 60-150 seconds	217°C 60-150 seconds
Peak	-Temperature (TP) -Time(tp)	235°C 10-30 seconds	260°C 20 - 40 second
Ramp-Down	Rate	6°C / second max.	6°C / second max.
Time from 25°C to Peak Temperature		6 minutes max	8 minutes max.

Reflow Profile

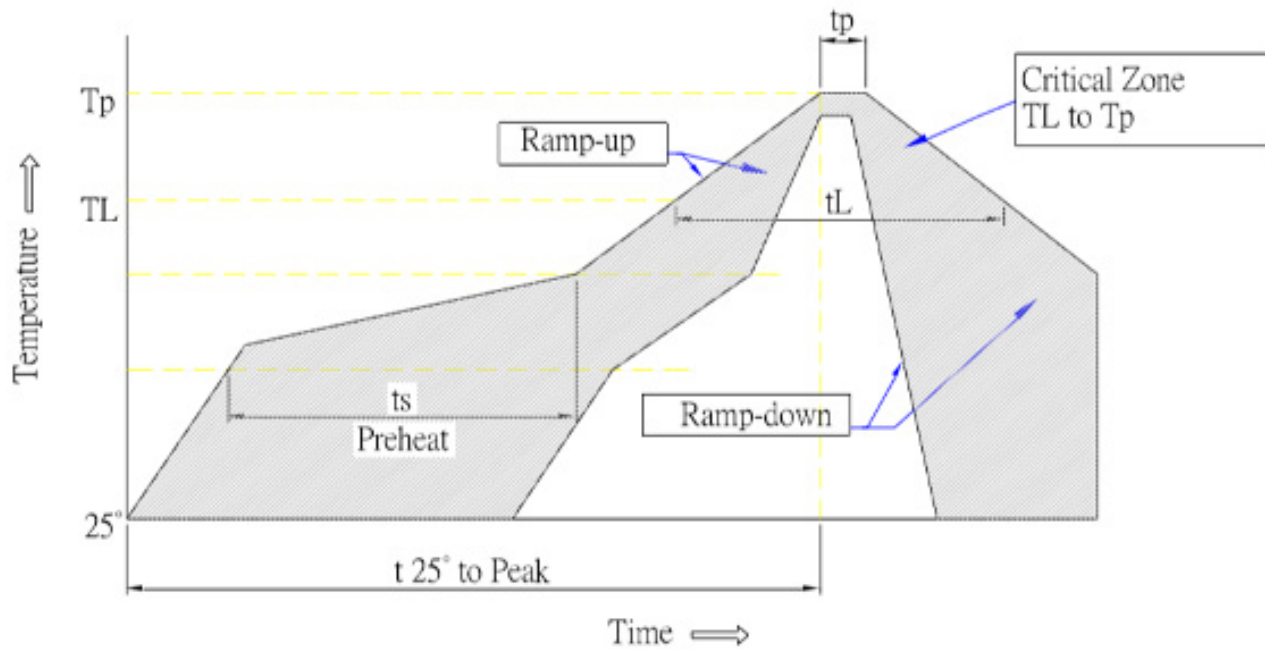

Temperatures profile

4G/LTE Ceramic Chip Antenna



ACAR3705-S698



37.0 x 5.0 x 5.0 mm
RoHS/RoHS II Compliant
MSL = NA

Packaging

Tape Dimensions (mm)

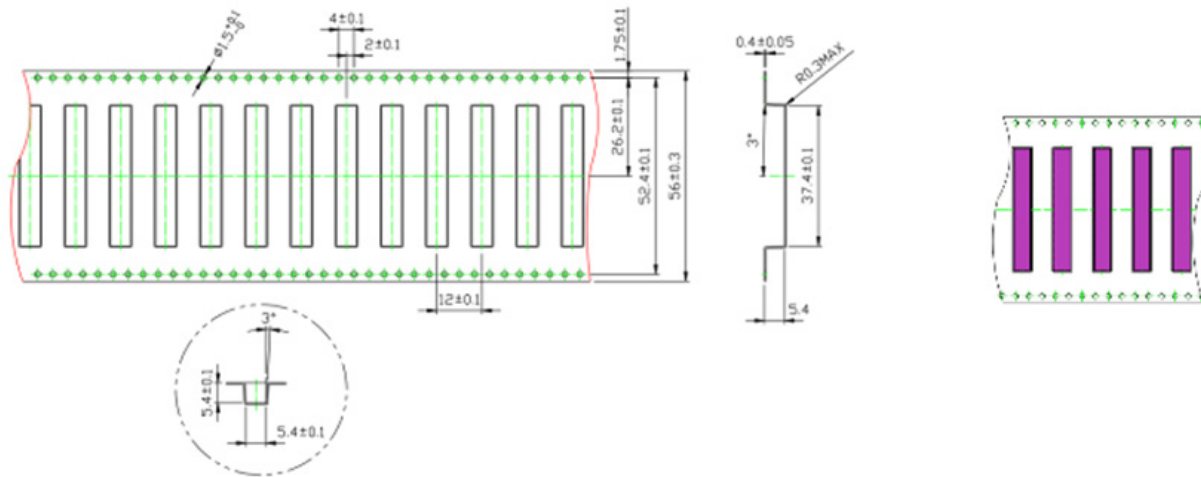

Reel Dimensions (mm)

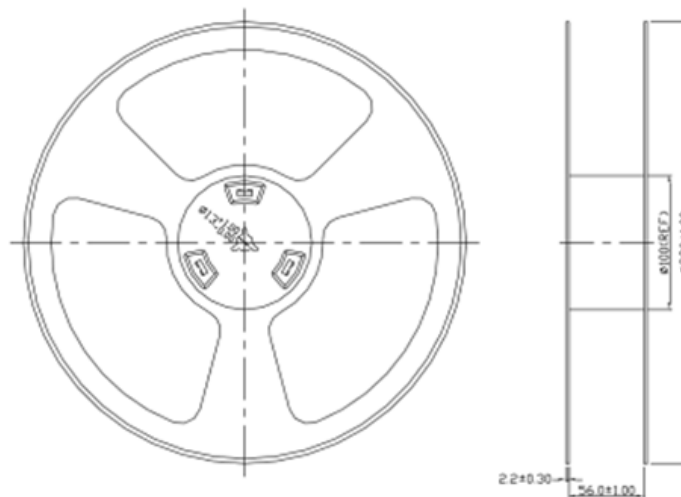

1. Blister tape to IEC 286-3, polyester.
2. Pieces per tape /reel: 450pcs
3. MOQ: 1350pcs (3 x reels)

ATTENTION: Abracon LLC's products are COTS – Commercial-Off-The-Shelf products; suitable for Commercial, Industrial and, where designated, Automotive Applications. Abracon's products are not specifically designed for Military, Aviation, Aerospace, Life-dependant Medical applications or any application requiring high reliability where component failure could result in loss of life and/or property. For applications requiring high reliability and/or presenting an extreme operating environment, written consent and authorization from Abracon LLC is required. Please contact Abracon LLC for more information.



5101 Hidden Creek Ln Spicewood TX 78669
Phone: 512-371-6159 | Fax: 512-351-8858
For terms and conditions of sales, please visit:
www.abracon.com

REVISED: 04.17.2020

ABRACON IS
ISO9001-2015
CERTIFIED

Mouser Electronics

Authorized Distributor

Click to View Pricing, Inventory, Delivery & Lifecycle Information:

[ABRACON:](#)

[ACAR3705-S698](#)