

Schematic Symbol

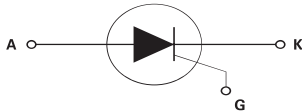

Main Features

Symbol	Value	Unit
$I_{T(RMS)}$	16	A
V_{DRM}/V_{RRM}	600	V
I_{GT}	6	mA

Description

this SV6016Dx high junction temperature SCR is ideal for unidirectional switches for phase control and general switching applications such as heating, motor control controls, converters / rectifiers and capacitive discharge ignitions.

Standard phase control SCRs are triggered with few milliamperes of current at less than 1.5V potential.

Features & Benefits

- RoHS compliant
- 150°C maximum junction temperature
- Surge capability up to 200 A at 60 Hz half cycle

Applications

Typical applications include AC Generator (ACG) rectifiers, battery voltage regulators and generic converters and inrush current controller in various AC to DC applications. Additional applications include controls for power tools, home/brown good and white goods appliances.

Absolute Maximum Ratings

Symbol	Parameter	Test Conditions	Value	Unit
V_{DSM}/V_{RSM}	Peak non-repetitive blocking voltage	$P_w = 100 \mu s$	$V_{DRM}/V_{RRM} + 100$	V
$I_{T(RMS)}$	RMS on-state current	$T_c = 130^\circ C$	16	A
$I_{T(AV)}$	Average on-state current	$T_c = 130^\circ C$	10.2	A
I_{TSM}	Peak non-repetitive surge current (single half cycle, T_j (initial) = 25°C)	$f = 50Hz$	180	A
		$f = 60Hz$	200	
I^2t	I^2t Value for fusing	$t_p = 8.3 ms$	200	A^2s
di/dt	Critical rate of rise of on-state current	$f = 60Hz; T_j = 150^\circ C$	100	$A/\mu s$
I_{GM}	Peak gate current	$T_j = 150^\circ C$	4	A
$P_{G(AV)}$	Average gate power dissipation	$T_j = 150^\circ C$	0.8	W
T_{stg}	Storage temperature range		-40 to 150	°C
T_j	Operating junction temperature range		-40 to 150	

Electrical Characteristics ($T_J = 25^\circ\text{C}$, unless otherwise specified)

Symbol	Test Conditions	Value	Unit
I_{GT}	$V_D = 12\text{V}$ $R_L = 60\ \Omega$	MAX.	6
		MIN.	1.5
V_{GT}	$V_D = 12\text{V}$ $R_L = 60\ \Omega$	MAX.	1.5
dv/dt	$V_D = 67\% V_{DRM}$; gate open; $T_J = 125^\circ\text{C}$	MIN.	200
	$V_D = 67\% V_{DRM}$; gate open; $T_J = 150^\circ\text{C}$		100
V_{GD}	$V_D = V_{DRM}$ $R_L = 3.3\ \text{k}\Omega$ $T_J = 150^\circ\text{C}$	MIN.	0.2
I_H	$I_T = 200\text{mA}$ (initial)	MAX.	40
t_q	$I_T = 2\text{A}$; $t_p = 50\ \mu\text{s}$; dv/dt = 5V/ μs ; di/dt = 30A/ μs	MAX.	50
t_{gt}	$I_G = 2 \times I_{GT}$ PW = 15 μs $I_T = 24\text{A}$	TYP.	2.3

Static Characteristics

Symbol	Test Conditions	Value	Unit
V_{TM}	Component $I_T = 32\text{A}$; $t_p = 380\ \mu\text{s}$	MAX.	1.6
I_{DRM} / I_{RRM}	$V_{DRM} = V_{RRM}$	$T_J = 25^\circ\text{C}$	10
		$T_J = 125^\circ\text{C}$	500
		$T_J = 150^\circ\text{C}$	2000

Thermal Resistances

Symbol	Parameter	Value	Unit
$R_{\theta(JC)}$	Junction to case (AC)	1.4	$^\circ\text{C}/\text{W}$

Figure 1: Normalized DC Gate Trigger Current vs. Junction Temperature

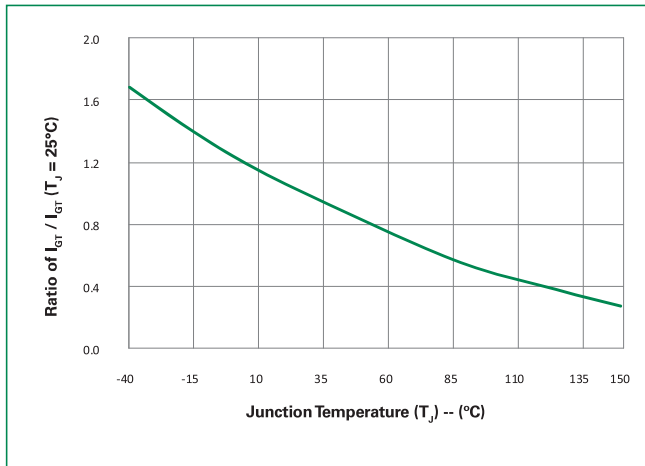

Figure 2: Normalized DC Gate Trigger Voltage vs. Junction Temperature

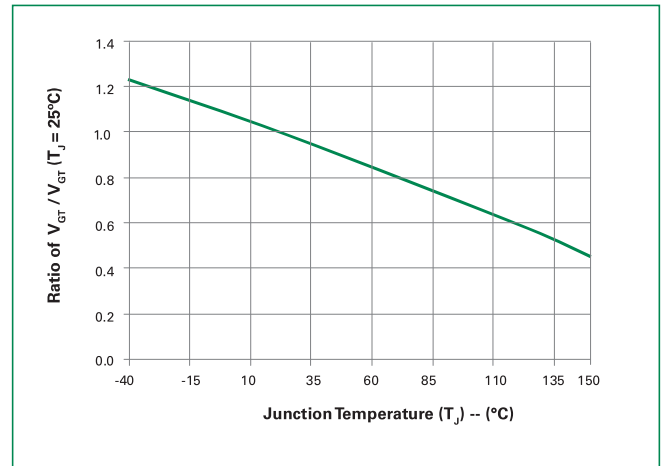

Figure 3: Normalized DC Holding Current vs. Junction Temperature

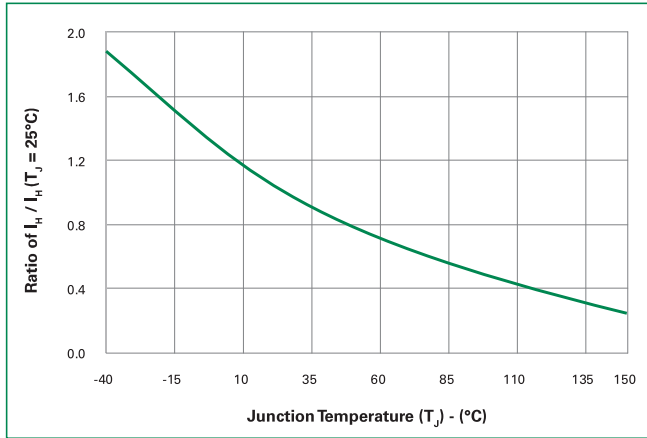

Figure 4: On-State Current vs. On-State Voltage (Typical)

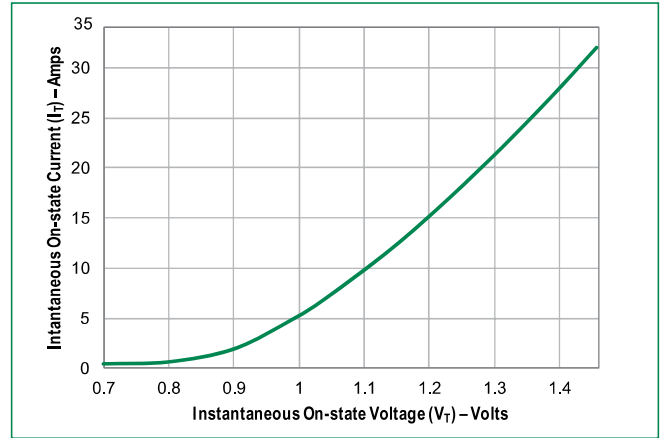

Figure 5: Power Dissipation (Typical) vs. RMS On-State Current

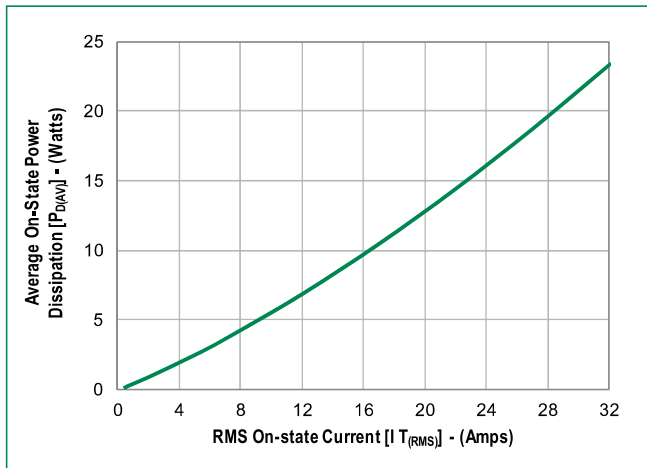

Figure 6: Maximum Allowable Case Temperature vs. RMS On-State Current

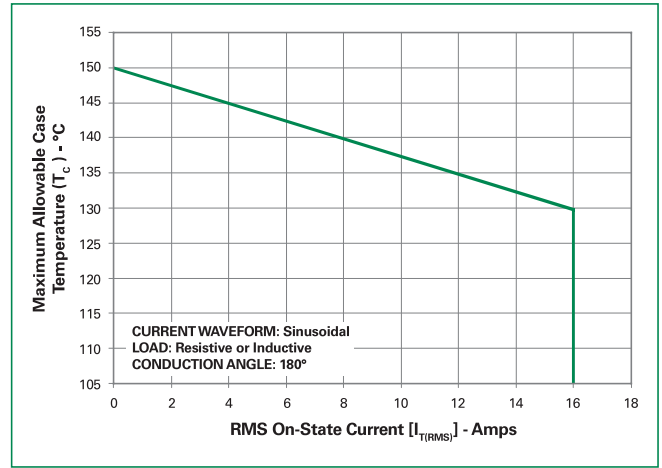

Figure 7: Maximum Allowable Case Temperature vs. Average On-State Current

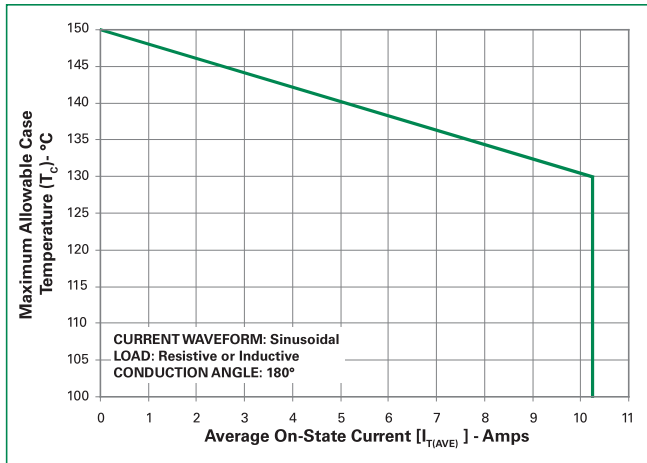

Figure 8: Peak Capacitor Discharge Current

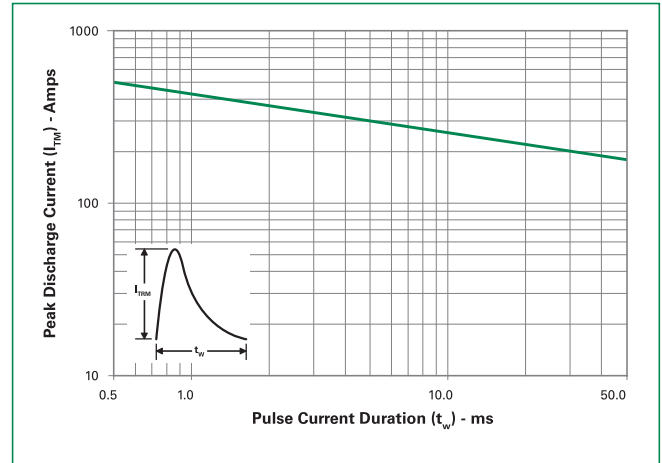

Figure 9: Peak Capacitor Discharge Current Derating

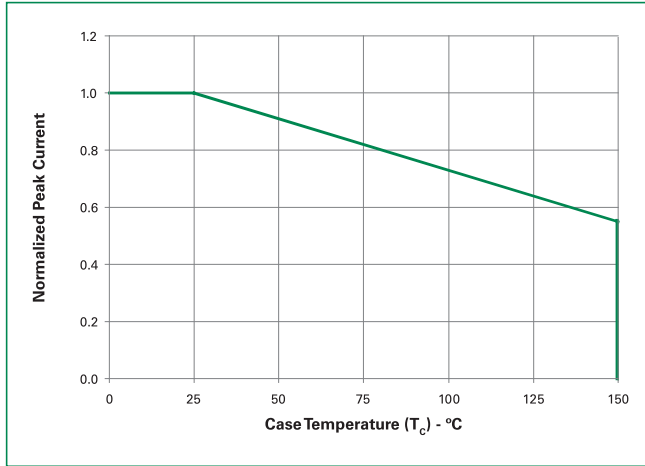
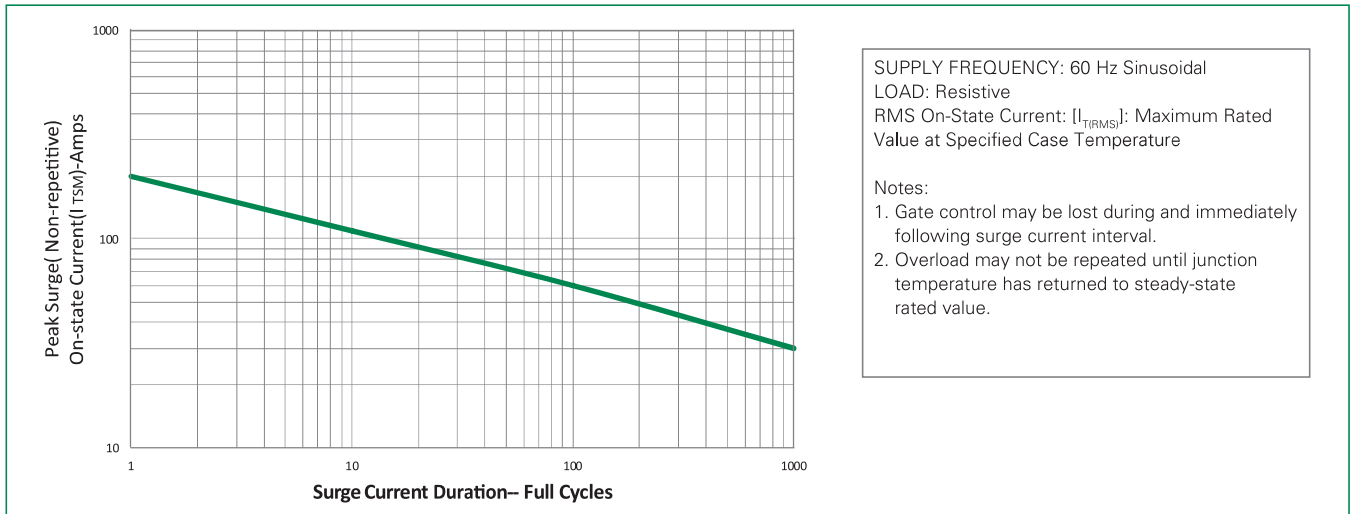
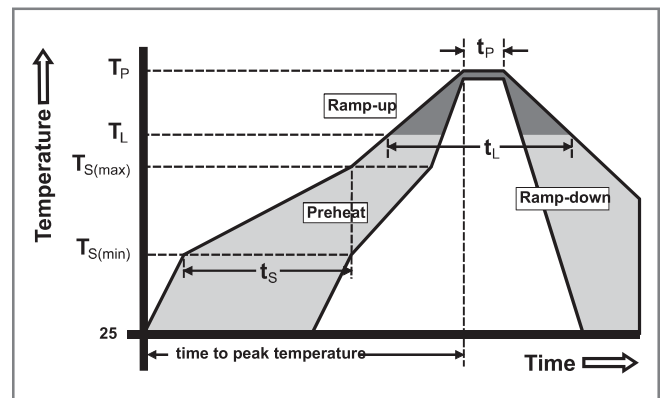

Figure 10: Surge Peak On-State Current vs. Number of Cycles



Soldering Parameters

Reflow Condition		Pb – Free assembly
Pre Heat	- Temperature Min ($T_{s(min)}$)	150°C
	- Temperature Max ($T_{s(max)}$)	200°C
	- Time (min to max) (t_s)	60 – 180 secs
Average ramp up rate (Liquidus Temp (T_L) to peak)		5°C/second max
$T_{s(max)}$ to T_L - Ramp-up Rate		5°C/second max
Reflow	- Temperature (T_L) (Liquidus)	217°C
	- Time (t_L)	60 – 150 seconds
Peak Temperature (T_p)		260 ^{+0/-5} °C
Time within 5°C of actual peak Temperature (t_p)		20 – 40 seconds
Ramp-down Rate		5°C/second max
Time 25°C to peak Temperature (T_p)		8 minutes Max.
Do not exceed		280°C



Physical Specifications

Terminal Finish	100% Matte Tin-plated
Body Material	UL Recognized compound meeting flammability rating V-0
Lead Material	Copper Alloy

Design Considerations

Careful selection of the correct component for the application's operating parameters and environment will go a long way toward extending the operating life of the Thyristor. Good design practice should limit the maximum continuous current through the main terminals to 75% of the component rating. Other ways to ensure long life for a power discrete semiconductor are proper heat sinking and selection of voltage ratings for worst case conditions. Overheating, overvoltage (including dv/dt), and surge currents are the main killers of semiconductors. Correct mounting, soldering, and forming of the leads also help protect against component damage.

Environmental Specifications

Test	Specifications and Conditions
AC Blocking	MIL-STD-750, M-1040, Cond A Applied Peak AC voltage @ 150°C for 1008 hours
Temperature Cycling	MIL-STD-750, M-1051, 100 cycles; -55°C to +150°C; 15-min dwell-time
Temperature/Humidity	EIA / JEDEC, JESD22-A101 1008 hours; 160V - DC: 85°C; 85% rel humidity
High Temp Storage	MIL-STD-750, M-1031, 1008 hours; 150°C
Low-Temp Storage	1008 hours; -40°C
Resistance to Solder Heat	MIL-STD-750 Method 2031
Solderability	ANSI/J-STD-002, category 3, Test A
Lead Bend	MIL-STD-750, M-2036 Cond E
Moisture Sensitivity Level	Level 1, JEDEC-J-STD-020D

Dimensions — TO-252AA (D-Package) — D-PAK Surface Mount

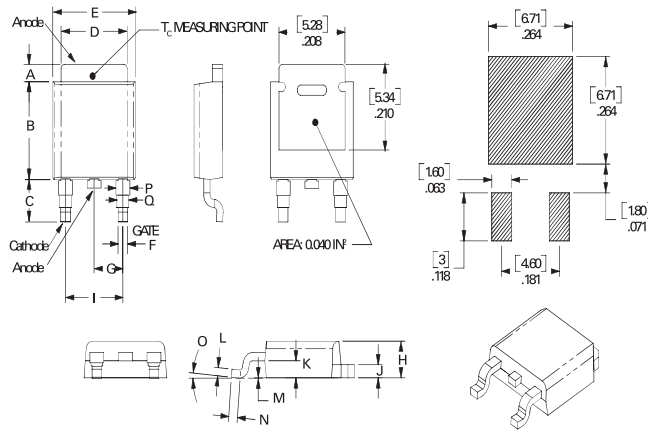

Dimension	Inches			Millimeters		
	Min	Typ	Max	Min	Typ	Max
A	0.040	0.043	0.050	1.02	1.09	1.27
B	0.235	0.243	0.245	5.97	6.16	6.22
C	0.106	0.108	0.113	2.69	2.74	2.87
D	0.205	0.208	0.213	5.21	5.29	5.41
E	0.255	0.262	0.265	6.48	6.65	6.73
F	0.027	0.031	0.033	0.69	0.80	0.84
G	0.087	0.090	0.093	2.21	2.28	2.36
H	0.085	0.092	0.095	2.16	2.33	2.41
I	0.176	0.179	0.184	4.47	4.55	4.67
J	0.018	0.020	0.023	0.46	0.51	0.58
K	0.038	0.040	0.044	0.97	1.02	1.12
L	0.018	0.020	0.023	0.46	0.51	0.58
M	0.000	0.000	0.004	0.00	0.00	0.10
N	0.021	0.026	0.027	0.53	0.67	0.69
O	0°	0°	5°	0°	0°	5°
P	0.042	0.047	0.052	1.06	1.20	1.32
Q	0.034	0.039	0.044	0.86	1.00	1.11

Packing Options

Part Number	Marking	Weight	Packing Mode	Base Quantity
SV6016D1TP	SV6016D1	0.3 g	Tube	750 (75 per tube)
SV6016D1RP	SV6016D1	0.3 g	Tape & Reel	2500

Part Numbering System

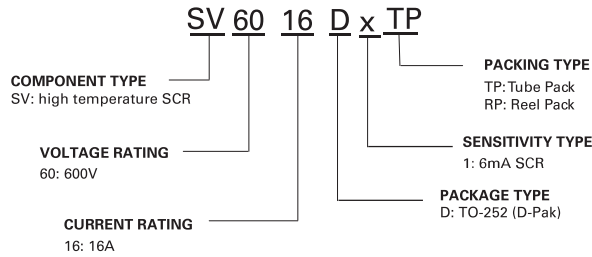

Part Marking System

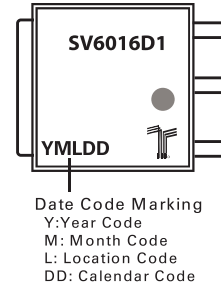

TO-252 Embossed Carrier Reel Pack (RP) Specifications

Meets all EIA-481-2 Standards

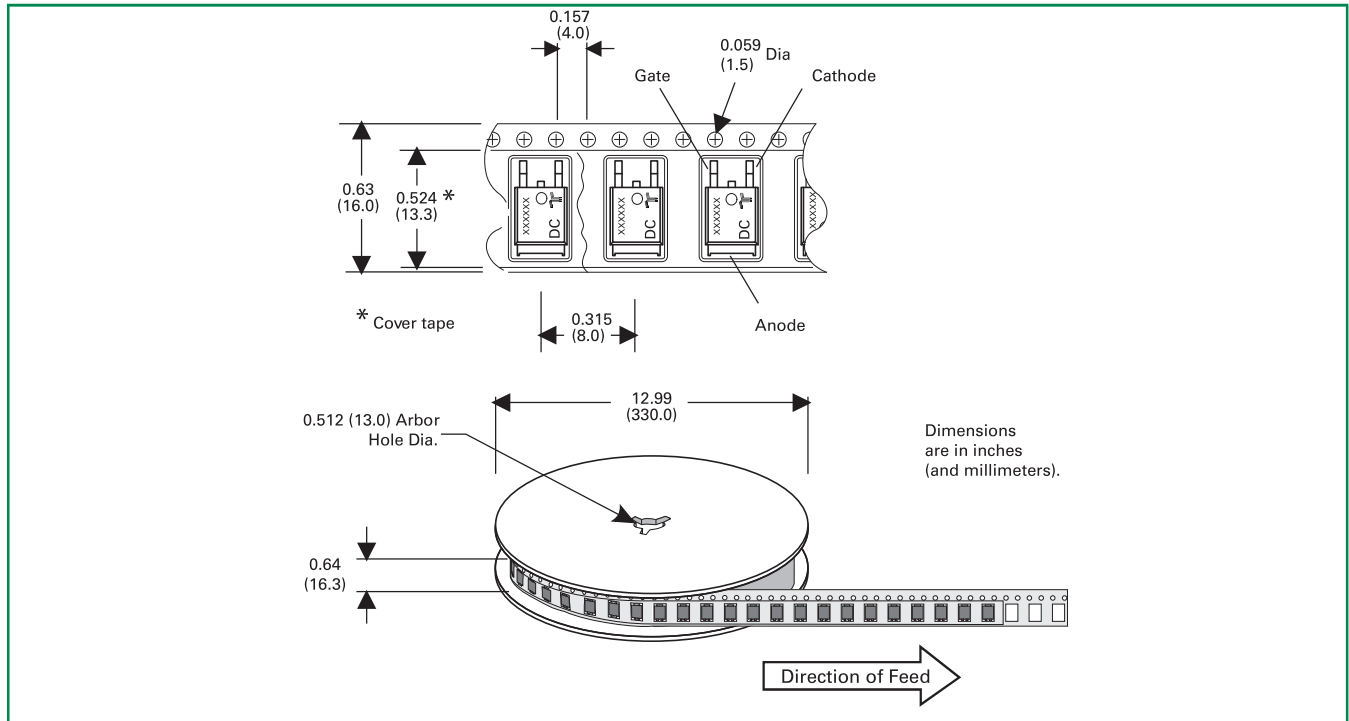

Disclaimer Notice - Information furnished is believed to be accurate and reliable. However, users should independently evaluate the suitability of and test each product selected for their own applications. Littelfuse products are not designed for, and may not be used in, all applications. Read complete Disclaimer Notice at <http://www.littelfuse.com/disclaimer-electronics>.