

General Description

The AOD3N50 & AOU3N50 have been fabricated using an advanced high voltage MOSFET process that is designed to deliver high levels of performance and robustness in popular AC-DC applications. By providing low $R_{DS(ON)}$, C_{ISS} and C_{RSS} along with guaranteed avalanche capability these parts can be adopted quickly into new and existing offline power supply designs.

Product Summary

V_{DS}	600V@150°C
I_D (at $V_{GS}=10V$)	2.8A
$R_{DS(ON)}$ (at $V_{GS}=10V$)	< 3Ω

100% UIS Tested!
 100% R_g Tested!

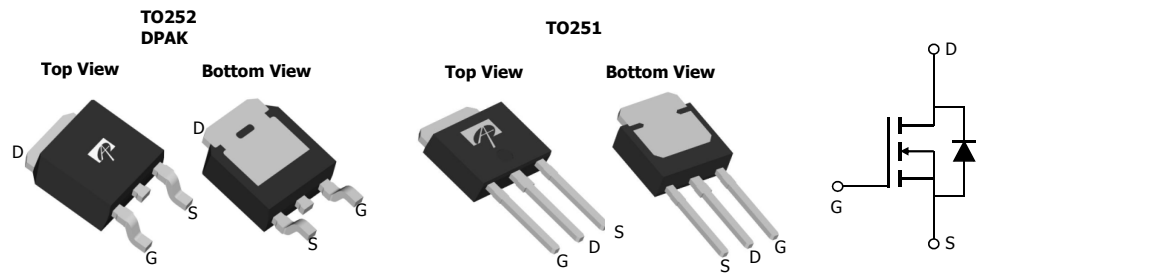

Absolute Maximum Ratings $T_A=25^\circ C$ unless otherwise noted

Parameter	Symbol	Maximum	Units
Drain-Source Voltage	V_{DS}	500	V
Gate-Source Voltage	V_{GS}	±30	V
Continuous Drain Current ^B	I_D	$T_C=25^\circ C$	2.8
		$T_C=100^\circ C$	1.8
Pulsed Drain Current ^C	I_{DM}	9	A
Avalanche Current ^C	I_{AR}	2	A
Repetitive avalanche energy ^C	E_{AR}	60	mJ
Single pulsed avalanche energy ^H	E_{AS}	120	mJ
MOSFET dv/dt ruggedness	dv/dt	50	V/ns
Peak diode recovery dv/dt		5	
Power Dissipation ^B	P_D	$T_C=25^\circ C$	57
		Derate above 25°C	0.45
Junction and Storage Temperature Range	T_J, T_{STG}	-50 to 150	°C
Maximum lead temperature for soldering purpose, 1/8" from case for 5 seconds	T_L	300	°C

Thermal Characteristics

Parameter	Symbol	Typical	Maximum	Units
Maximum Junction-to-Ambient ^{A,G}	$R_{\theta JA}$	45	55	°C/W
Maximum Case-to-sink ^A	$R_{\theta CS}$	-	0.5	°C/W
Maximum Junction-to-Case ^{D,F}	$R_{\theta JC}$	1.8	2.2	°C/W

Electrical Characteristics (T_J=25°C unless otherwise noted)

Symbol	Parameter	Conditions	Min	Typ	Max	Units
STATIC PARAMETERS						
BV _{DSS}	Drain-Source Breakdown Voltage	I _D =250μA, V _{GS} =0V, T _J =25°C	500			V
		I _D =250μA, V _{GS} =0V, T _J =150°C		600		
BV _{DSS} /ΔT _J	Zero Gate Voltage Drain Current	I _D =250μA, V _{GS} =0V		0.54		V/°C
I _{DSS}	Zero Gate Voltage Drain Current	V _{DS} =500V, V _{GS} =0V			1	μA
		V _{DS} =400V, T _J =125°C			10	
I _{GSS}	Gate-Body leakage current	V _{DS} =0V, V _{GS} =±30V			±100	nA
V _{GS(th)}	Gate Threshold Voltage	V _{DS} =5V, I _D =250μA	3.5	4.1	4.5	V
R _{DS(ON)}	Static Drain-Source On-Resistance	V _{GS} =10V, I _D =1.5A		2.3	3	Ω
g _{FS}	Forward Transconductance	V _{DS} =40V, I _D =1.5A		2.8		S
V _{SD}	Diode Forward Voltage	I _S =1A, V _{GS} =0V		0.78	1	V
I _S	Maximum Body-Diode Continuous Current				3	A
I _{SM}	Maximum Body-Diode Pulsed Current				9	A
DYNAMIC PARAMETERS						
C _{iss}	Input Capacitance	V _{GS} =0V, V _{DS} =25V, f=1MHz	221	276	331	pF
C _{oss}	Output Capacitance		25	31.4	38	pF
C _{riss}	Reverse Transfer Capacitance		2.1	2.6	4.1	pF
R _g	Gate resistance	V _{GS} =0V, V _{DS} =0V, f=1MHz	1.9	3.9	5.9	Ω
SWITCHING PARAMETERS						
Q _g	Total Gate Charge	V _{GS} =10V, V _{DS} =400V, I _D =3A		6.7	8.0	nC
Q _{gs}	Gate Source Charge		1.7	3.0	nC	
Q _{gd}	Gate Drain Charge		2.7	3.2	nC	
t _{D(on)}	Turn-On DelayTime	V _{GS} =10V, V _{DS} =250V, I _D =3A, R _G =25Ω		11	13.2	ns
t _r	Turn-On Rise Time		19	23.0	ns	
t _{D(off)}	Turn-Off DelayTime		20.5	24.6	ns	
t _f	Turn-Off Fall Time		15	18.0	ns	
t _{rr}	Body Diode Reverse Recovery Time		I _F =3A, di/dt=100A/μs, V _{DS} =100V	134	161	ns
Q _{rr}	Body Diode Reverse Recovery Charge	I _F =3A, di/dt=100A/μs, V _{DS} =100V	0.89	1.1	μC	

A. The value of R_{θJA} is measured with the device in a still air environment with T_A=25° C.

B. The power dissipation P_D is based on T_{J(MAX)}=150° C in a TO252 package, using junction-to-case thermal resistance, and is more useful in setting the upper dissipation limit for cases where additional heatsinking is used.

C. Repetitive rating, pulse width limited by junction temperature T_{J(MAX)}=150° C.

D. The R_{θJA} is the sum of the thermal impedance from junction to case R_{θJC} and case to ambient.

E. The static characteristics in Figures 1 to 6 are obtained using <300 μs pulses, duty cycle 0.5% max.

F. These curves are based on the junction-to-case thermal impedance which is measured with the device mounted to a large heatsink, assuming a maximum junction temperature of T_{J(MAX)}=150° C.

G. These tests are performed with the device mounted on 1 in² FR-4 board with 2oz. Copper, in a still air environment with T_A=25° C.

H. L=60mH, I_{AS}=2A, V_{DB}=150V, R_G=10Ω, Starting T_J=25° C

APPLICATIONS OR USE AS CRITICAL COMPONENTS IN LIFE SUPPORT DEVICES OR SYSTEMS ARE NOT AUTHORIZED. AOS DOES NOT ASSUME ANY LIABILITY ARISING OUT OF SUCH APPLICATIONS OR USES OF ITS PRODUCTS. AOS RESERVES THE RIGHT TO IMPROVE PRODUCT DESIGN, FUNCTIONS AND RELIABILITY WITHOUT NOTICE.

TYPICAL ELECTRICAL AND THERMAL CHARACTERISTICS

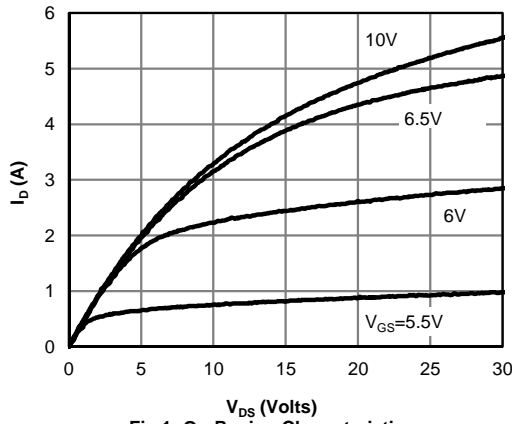

Fig 1: On-Region Characteristics

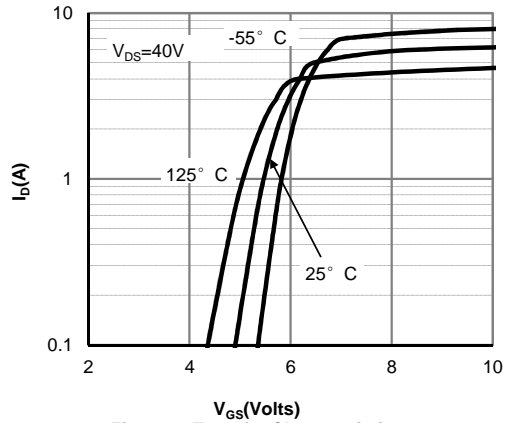

Figure 2: Transfer Characteristics

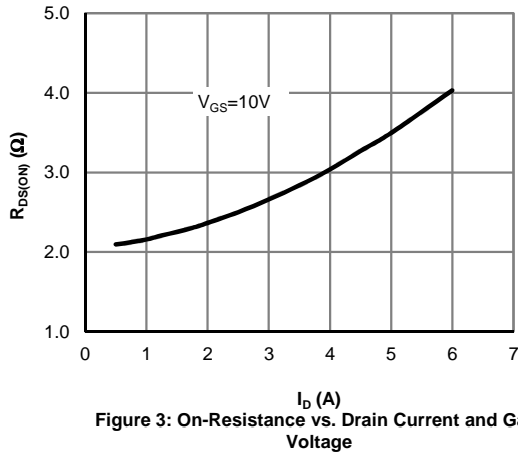

Figure 3: On-Resistance vs. Drain Current and Gate Voltage

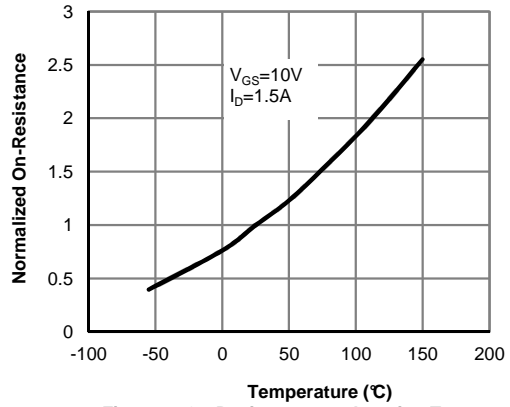

Figure 4: On-Resistance vs. Junction Temperature

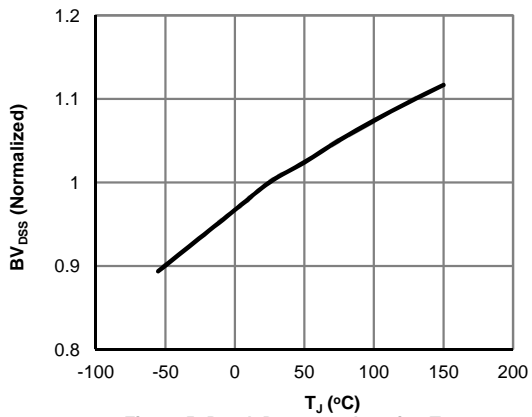

Figure 5: Break Down vs. Junction Temperature

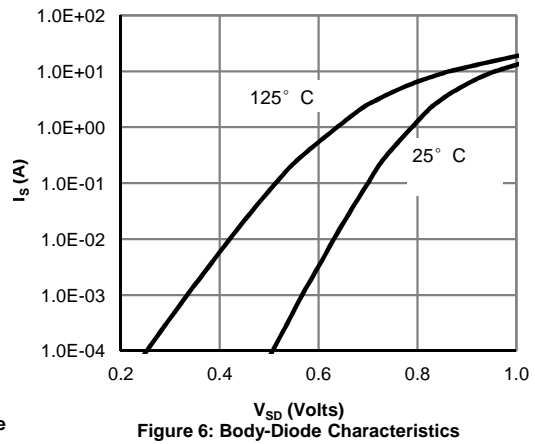

Figure 6: Body-Diode Characteristics

TYPICAL ELECTRICAL AND THERMAL CHARACTERISTICS

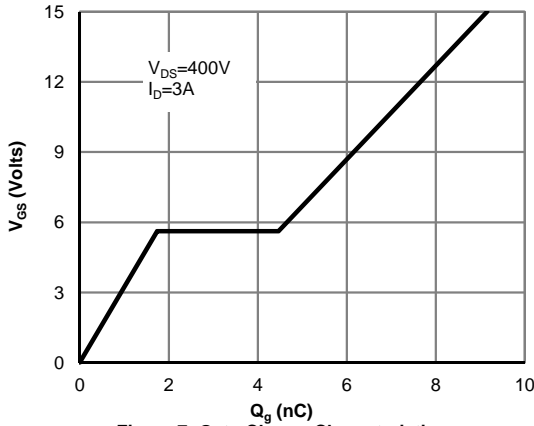

Figure 7: Gate-Charge Characteristics

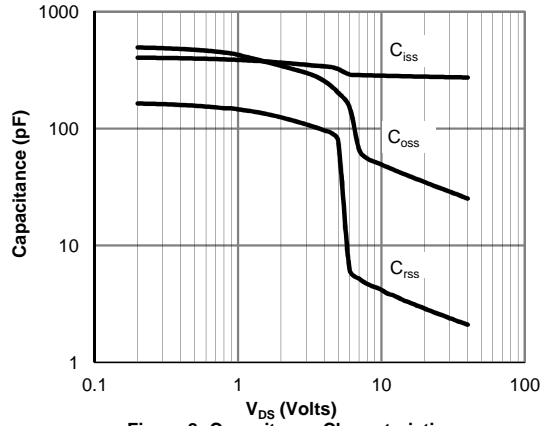

Figure 8: Capacitance Characteristics

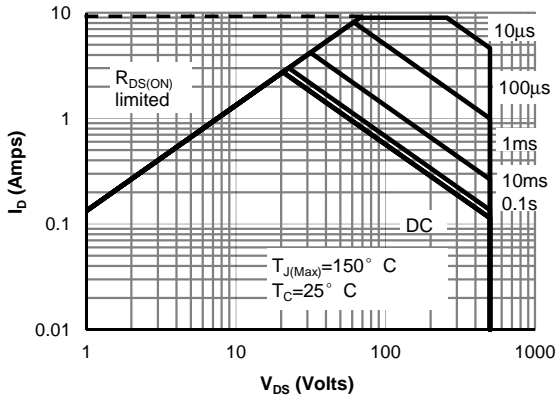

Figure 9: Maximum Forward Biased Safe Operating Area (Note F)

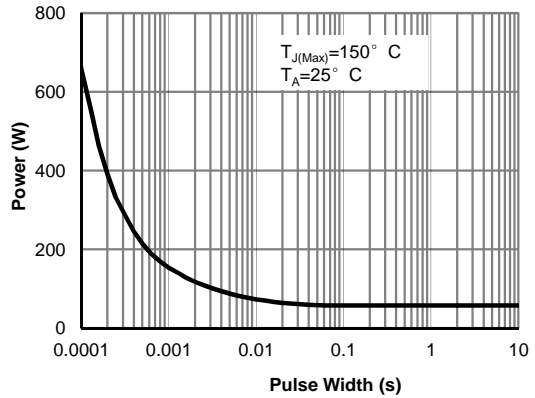

Figure 10: Single Pulse Power Rating Junction-to-Case (Note F)

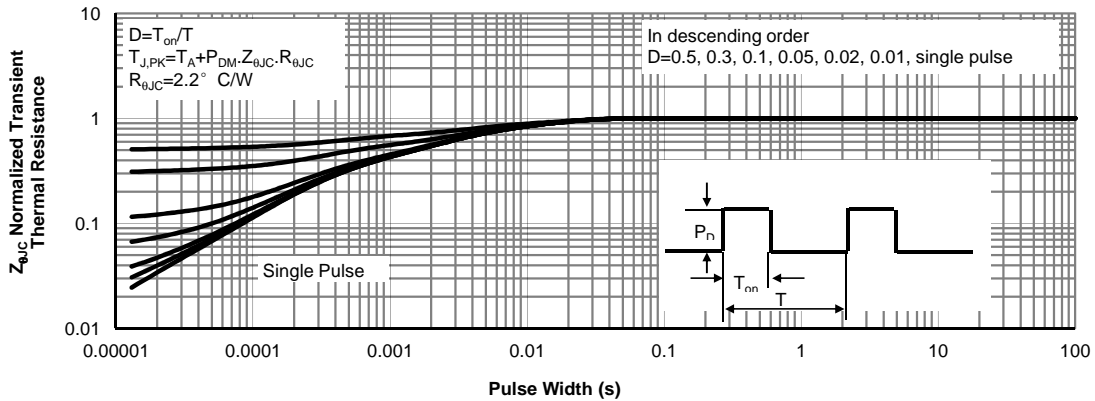

Figure 11: Normalized Maximum Transient Thermal Impedance (Note F)

TYPICAL ELECTRICAL AND THERMAL CHARACTERISTICS

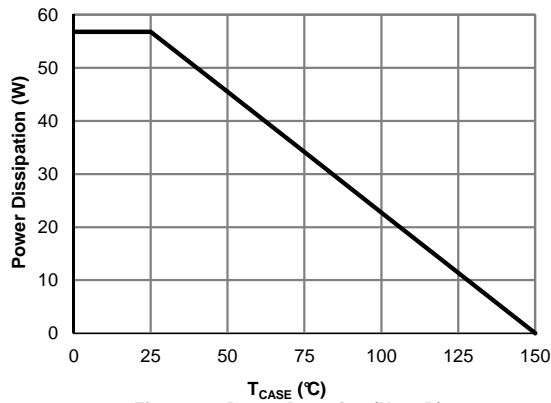

Figure 12: Power De-rating (Note B)

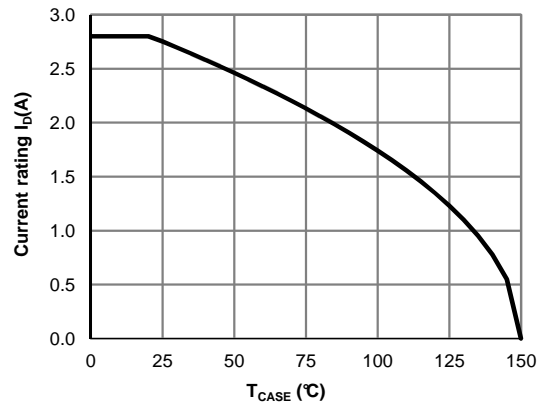

Figure 13: Current De-rating (Note B)

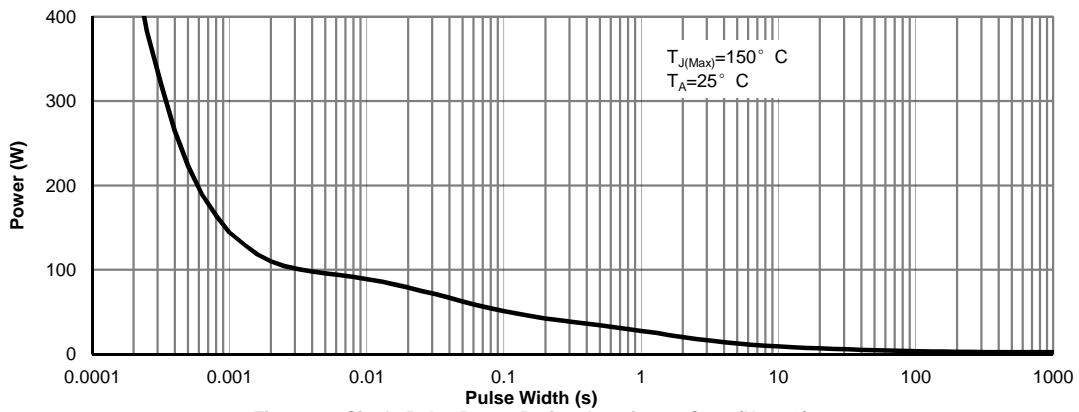

Figure 14: Single Pulse Power Rating Junction-to-Case (Note G)

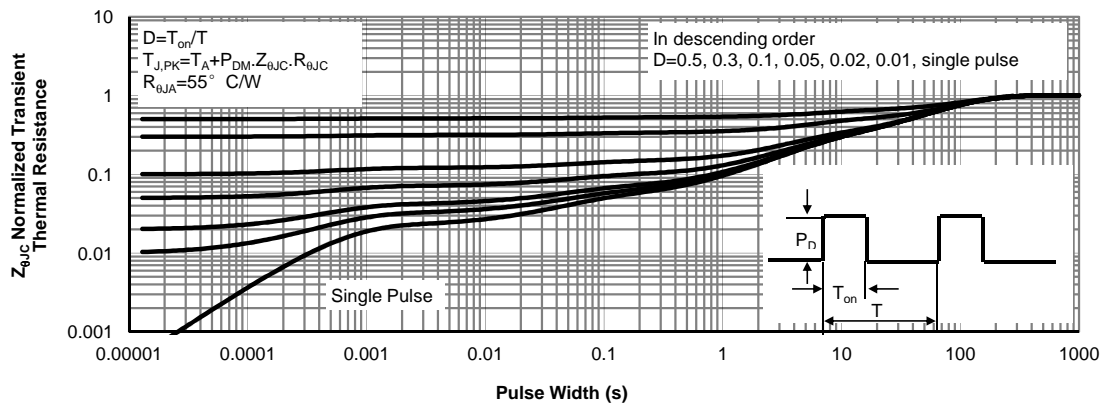
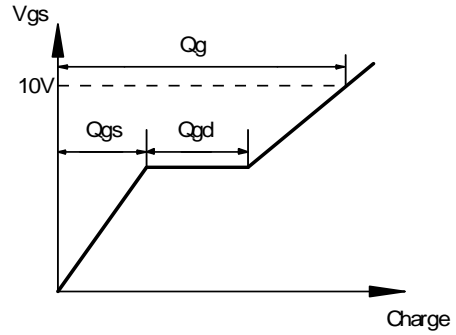
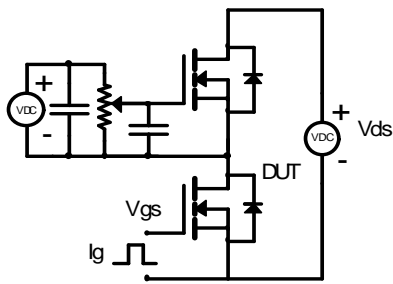
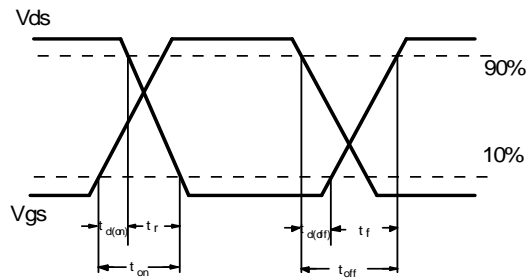
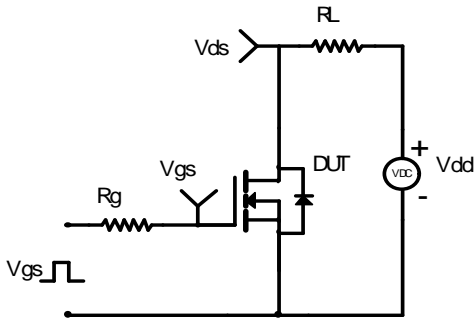

Figure 15: Normalized Maximum Transient Thermal Impedance (Note G)

Gate Charge Test Circuit & Waveform



Resistive Switching Test Circuit & Waveforms



Unclamped Inductive Switching (UIS) Test Circuit & Waveforms

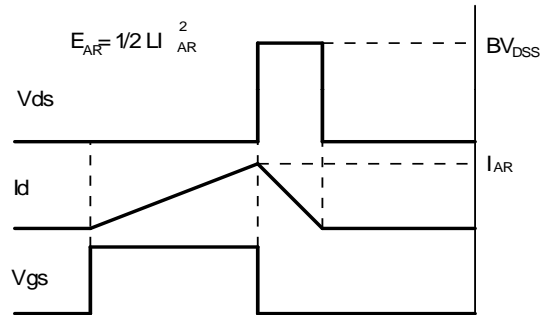
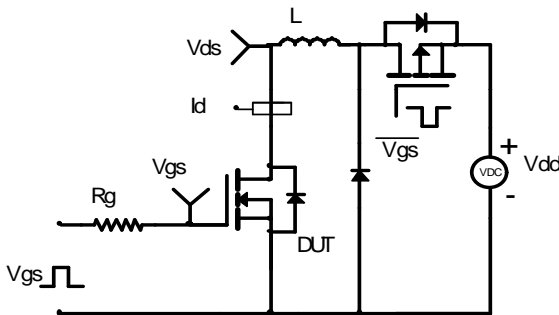

Diode Recovery Test Circuit & Waveforms

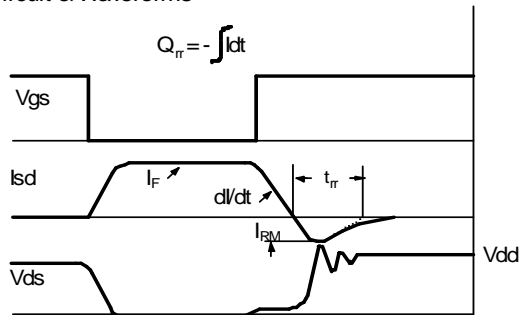
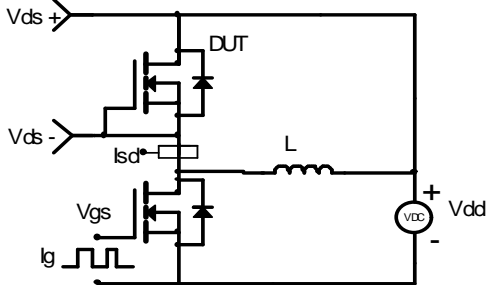



Document No.	PD-01204
Version	A
Title	AOU3N50 Marking Description

TO251 PACKAGE MARKING DESCRIPTION

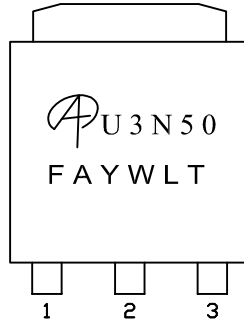

Green product

NOTE:
LOGO - AOS Logo
U3N50 - Part number code
F - Fab code
A - Assembly location code
Y - Year code
W - Week code
L&T - Assembly lot code

PART NO.	DESCRIPTION	CODE
AOU3N50	Green product	U3N50
AOU3N50L	Green product	U3N50



TO251 PACKAGE OUTLINE

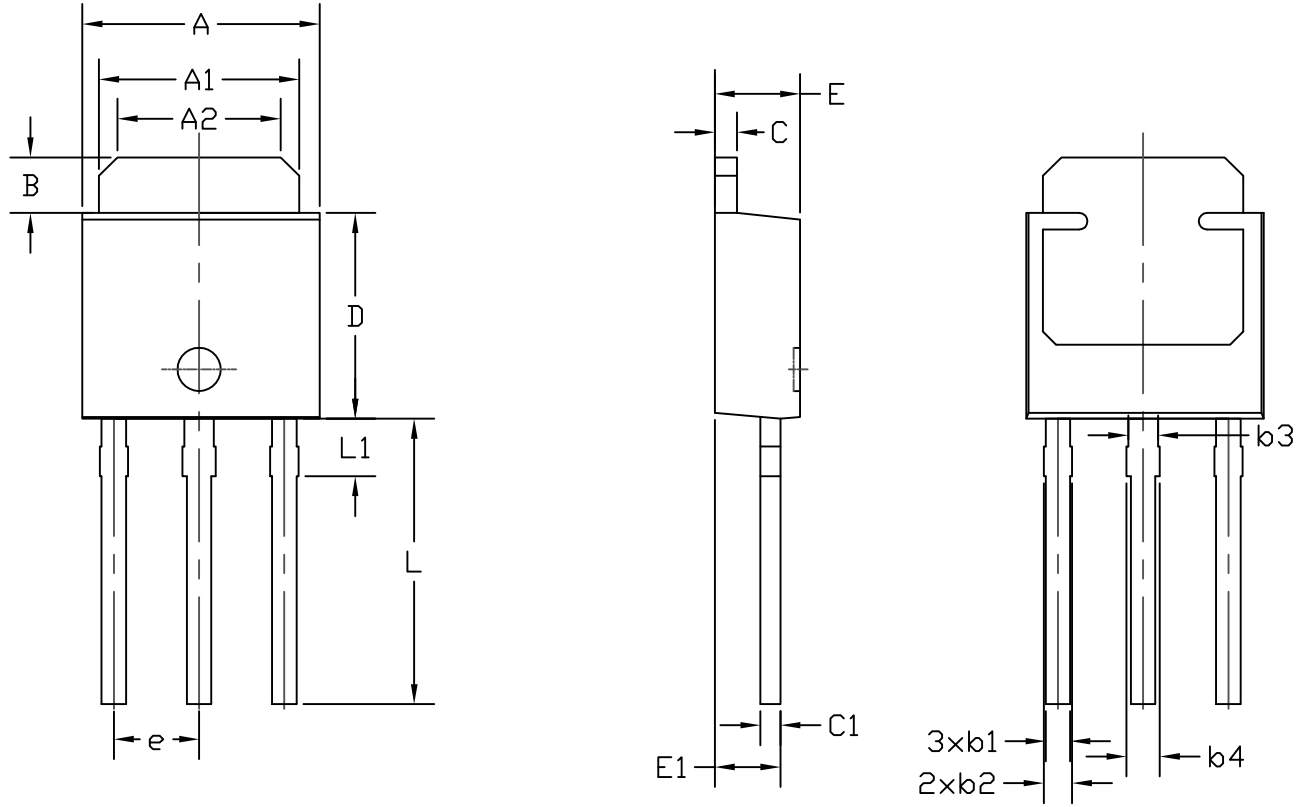

RECOMMENDED LAND PATTERN

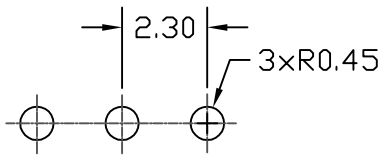

UNIT:mm

SYMBOLS	DIMENSIONS IN MILLIMETERS			DIMENSIONS IN INCHES		
	MIN	NOM	MAX	MIN	NOM	MAX
A	6.4	6.5	6.6	0.252	0.256	0.260
A1	5.3	5.4	5.5	0.209	0.213	0.217
A2	4.3	4.4	4.5	0.169	0.173	0.177
B	1.35	1.5	1.65	0.053	0.059	0.065
L1	1.55 REF			0.061REF		
L	7.4	7.7	8	0.291	0.303	0.315
D	5.4	5.55	5.7	0.213	0.219	0.224
C	0.55	0.6	0.65	0.022	0.024	0.026
C1	0.49	0.54	0.59	0.019	0.021	0.023
E1	1.72	1.77	1.82	0.068	0.070	0.072
E	2.2	2.3	2.4	0.087	0.091	0.094
b1	0.6	---	0.75	0.024	---	0.030
b2	0.7	---	0.85	0.028	---	0.033
b3	0.8			0.031		
b4	0.9			0.035		
e	2.3			0.091		

NOTE

1. PACKAGE BODY SIZES EXCLUDE MOLD FLASH AND GATE BURRS.
MOLD FLASH SHOULD BE LESS THAN 6 MIL.
2. TOLERANCE 0.100 MILLIMETERS UNLESS OTHERWISE SPECIFIED.
3. CONTROLLING DIMENSION IS MILLIMETER.
CONVERTED INCH DIMENSIONS ARE NOT NECESSARILY EXACT.
4. REFER TO JEDEC TO-251D AA.

TO251 PLASTIC TUBE DRAWING

REV.	DATE	DESCRIPTION	DRG.
A		NEW ISSUE	

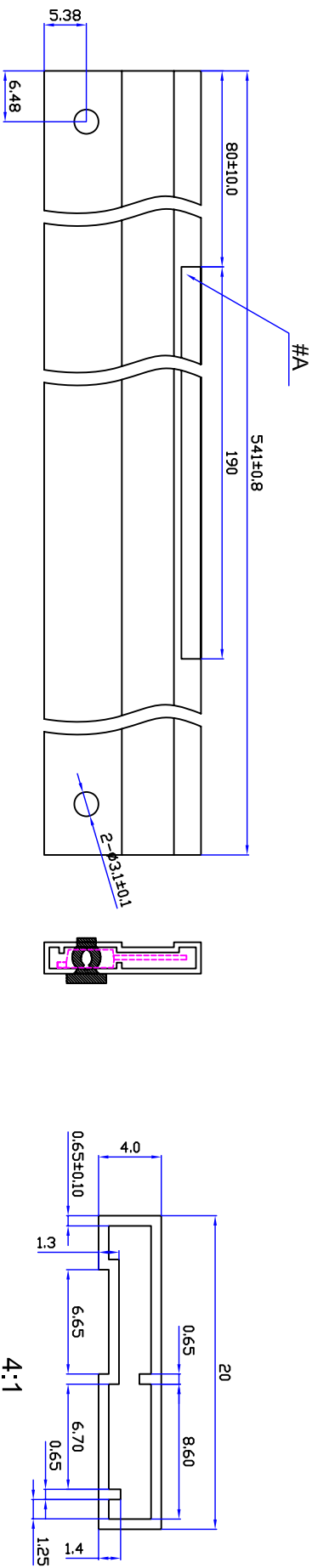

#A MARKING LAY-OUT (TOLS. ±2.0)

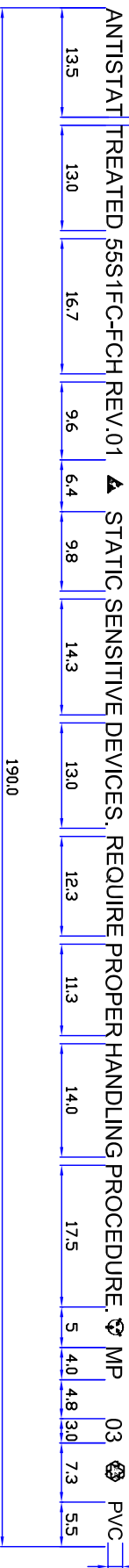

ANTISTAT TREATED 55S1FC-FCH REV.01 ▲ STATIC SENSITIVE DEVICES. REQUIRE PROPER HANDLING PROCEDURE. MP 03 PVC

(NOTE)

2:1

1. TUBE
 - MATERIAL : P.V.C
 - COLOR : TRANSPARENCY
 - MARKING #A : 6 MONTHS, BLACK COLOR
 - LETTER STYLE : Arial
 - CAMBAR : 1.5 MAX
 - ANTISTATIC TREATMENT, SURFACE
 - RESISTANCE : $1 \times 10^8 \sim 10^9 \Omega / \text{cm}^2$
 - FRICTION CAUSED STATIC < 100V

3. ALL UNSPECIFICATED SPECIFICATIONS FOLLOW TUBE GENERAL SPEC. UNSPECIFICATED TOLERANCE ± 0.2

4. PACKING Q'TY :

PKG	Q'TY(PCS)
TO251	80

2. PIN
 - MATERIAL: NYLON
 - COLOR : BLACK

DRAWN BY		SIGNATURE		TITLE	
APPROVED BY	SIGNATURE	UNIT	NM	PAGE	1 OF 1
SCALE	N.T.S.	PROJECTION	TR-00048	INCHOR CODE	N
				REV.	A



AOS Semiconductor Reliability Report

HVMOS Family Report, rev A

ALPHA & OMEGA Semiconductor, Inc

www.aosmd.com

This report applies for high voltage (900V/700V/650V/600V/500V) products assembled in following packages TO220 (F)/TO262 (F)/TO263/TO252 /TO251 (A).

“Commitment to Excellence at Quality & Reliability!”

To achieve this vision, AOS continuously strive for the excellence in design, manufacturing, reliability and proactively response to the customer’s feedback.

AOS ensures that all the product quality and reliability exceed the customer’s expectation by constantly assessing any potential risk, identifying cause of the suspected failures, driving corrective actions and developing prevention plan within the committed time through the continuously improvement.

This AOS product reliability report summarizes AOS Product Reliability result. The published product reliability data combines the results from new product Qualification Test Plan and routine Reliability Program activities. Accelerated environmental tests are performed on a specific sample size, and then followed by electrical test at end point. The released product will be categorized by the process family and be monitored on a quarterly basis for continuously improving the product quality. Table 1 lists the generic reliability qualification requirements and conditions:

Table 1: AOS Generic Reliability Qualification Requirements

Test Item	Test Condition	Time Point	Sample size	Acc/Reject
HTGB	Temp = 150°C , Vgs=100% of Vgsmax	168 / 500 hrs 1000 hrs	77 pcs / lot	0/1
HTRB	Temp = 150°C , Vds=80% of Vdsmax	168 / 500 hrs 1000 hrs	77 pcs / lot	0/1
Solder reflow precondition	168hr 85°C /85%RH + 3 cycle reflow @250°C (MSL level 1)	-	The sum of PCT ,TC and HAST	0/1
HAST	130 +/- 2°C , 85%RH, 33.3 psi, Vgs = 80% of Vgs max	100 hrs	55 pcs / lot	0/1
Pressure Pot	121°C , 29.7psi, 100%RH	96 hrs	77 pcs / lot	0/1
Temperature Cycle	-65°C to 150°C, air to air,	250 / 500 cycles	77 pcs / lot	0/1
Power Cycle	$\Delta T_j = 125 \text{ }^\circ\text{C}$	4286 cycles	77 pcs / lot	0/1

High Temperature Gate Bias (HTGB) & High Temperature Reverse Bias (HTRB)

HTGB burn-in stress is used to stress gate oxide at the elevated temperature environment hence any of the gate oxide integrity issue can be identified. HTRB burn-in stress is used to verify junction degradation under the maximum operation temperature.

Through HTGB & HTRB B/I stress test, the device lifetime in field operation & long term device level reliability can be determined. FIT rate is calculated by applying the Arrhenius equation with the activation energy of 0.7eV and 60% of upper confidence level at 55 deg C operating conditions.

Solder reflow precondition (pre-con)

Solder reflow precondition is the test that simulates shipment and storage of package in under uncontrollable environment. Precondition is the pre-requirement for the mechanical related reliability tests (such as Temperature Cycle, Pressure Pot and High Acceleration Stress TEST (HAST). The routine of the test are: parts will be soaked in moisture then bake in pressure pot, or being placed into 85% RH, 85 deg C environment for 168 hrs. Then they will be run through a solder reflow oven with temperature at 260°C± 5°C or 250°C± 5°C (depending on package thickness and volume). The test condition totally complies with MSL level 1. Pre-condition is a test that is detected package delamination, lifted bond wire issue.

Temperature Cycling (TC)

Temperature cycling test is to evaluate the mechanical integrity of the package and the interaction between the die and the package. This is an air to air test at temperature range from -65°C/150°C and stress duration is from 250 cycles to 500 cycles.

Pressure Pot (PCT)

PCT test is the test that measures the ability of the device withstand to moisture and contaminant environment. The test is done under enclosed chamber with the condition 121°C 15± 1PSIG, 100%RH and stress duration is 96 hrs.

High Acceleration Stress Test (HAST)

High acceleration stress test is to stress the devices under high humidity, high pressure environment under DC bias condition. If ionic contamination involved, the corrosion from metal layer can be accelerated by the HAST stress condition.

Power Cycle

The power cycle test is performed to determine that the ability of a device to withstand alternate exposures at high and low junction temperature extremes with operating biases periodically applied and removed. It is intended to simulate worst case conditions encountered in typical application.

The following tables summarize the qualification results based on the device/process families and the package types, respectively.

Summary of AOS High Voltage MOSFET product with TO220 (F)/TO262 (F)/TO263/TO252 /TO251 (A) package Qualification Results

Table 2 Product Family

Voltage	Device No.	Package
900V	AOTFXXN90	TO220F
700V	AOTFXXN70	TO220F
	AOTXXN70	TO220
650V	AOTFXXN65	TO220F
	AOTXXN65	TO220
	AOWFXXN65	TO262F
	AOWXXN65	TO262
600V	AOTFXXN60	TO-220F
	AOTXXN60	TO-220
	AOWFXXN60	TO262F
	AOWXXN60	TO262
	AOBXXN60(L)	TO263
	AODXXN60	TO252
	AOUXXN60	TO251
	AOIXXN60	TO251A
500V	AOWFXXN50	TO262F
	AOWXXN50	TO262
	AOTFXXN50	TO-220F
	AOTXXN50	TO-220
	AOBXXN50	TO263
	AODXXN50	TO252
	AOUXXN50	TO251

Note: Letter 'XX' is 1 or 2 digital which stands for Id (Continuous Drain current at 25°C) of this product. For example, AOTF14N50, '14' means Id of this product is 14A.

Table 3 Reliability Test and Package test Result:

Test Item	Test Condition	Time Point	Total Sample size	Number of failure
HTGB	Temp = 150°C , Vgs=100% of Vgsmax	168 / 500 hrs 1000 hrs	2541	0
HTRB	Temp = 150°C , Vds=80% of Vdsmax	168 / 500 hrs 1000 hrs	2464	0
Solder reflow precondition	168hr 85°C /85%RH + 3 cycle reflow @250°C /260°C (MSL level 1, peak temperature depending on package thickness and volume)	-	3839	0
HAST	130 +/- 2°C , 85%RH, 33.3 psi, Vgs = 80% of Vgs max	100 hrs	605	0
Pressure Pot	121°C , 29.7psi, 100%RH	96 hrs	1540	0
Temperature Cycle	-65°C to 150°C, air to air,	250 / 500 cycles	2002	0
Power Cycle	$\Delta T_j=125^\circ\text{C}$	4286 cycles	231	0
Solder dunk	260°C, 10secs	3 cycles	77	0



Reliability Evaluation:

FIT rate (per billion): 1.74

MTTF = 65789 years

The presentation of FIT rate for the individual product reliability is restricted by the actual burn-in sample size of the selected product. Failure Rate Determination is based on JEDEC Standard JESD 85. FIT means one failure per billion hours.

$$\text{Failure Rate (FIT)} = \text{Chi}^2 \times 10^9 / [2 (N) (H) (Af)] = 1.83 \times 10^9 / [2 (2541) (168) (258) + 2(1694) (500) (258) + 2(770) (1000) (258)] = 1.74$$

$$\text{MTTF} = 10^9 / \text{FIT} = 5.76 \times 10^8 \text{hrs} = 65789 \text{ years}$$

Chi² = Chi Squared Distribution, determined by the number of failures and confidence interval

N = Total Number of units from HTRB and HTGB tests

H = Duration of HTRB/HTGB testing

Af = Acceleration Factor from Test to Use Conditions (Ea = 0.7eV and Tuse = 55°C)

Acceleration Factor [**Af**] = **Exp** [Ea / k (1/Tj u – 1/Tj s)]

Acceleration Factor ratio list:

	55 deg C	70 deg C	85 deg C	100 deg C	115 deg C	130 deg C	150 deg C
Af	258	87	32	13	5.64	2.59	1

Tj s = Stressed junction temperature in degree (Kelvin), K = C+273.16

Tj u =The use junction temperature in degree (Kelvin), K = C+273.16

k = Boltzmann's constant, 8.617164 X 10⁻⁵eV / K