



GaAs PHEMT MMIC LOW NOISE AMPLIFIER, 2 - 4 GHz

Typical Applications

The HMC609LC4 is ideal for:

- Fixed Microwave
- Test & Measurement Equipment
- Radar & Sensors
- Military & Space

Features

- Excellent Gain Flatness: ± 0.4 dB
- High Gain: 20 dB
- Low Noise Figure: 3.5 dBm
- Output IP3: +36.5 dBm
- 50 Ohm Matched & DC Blocked RF I/Os
- RoHS Compliant 4 x 4 mm SMT Package

Functional Diagram

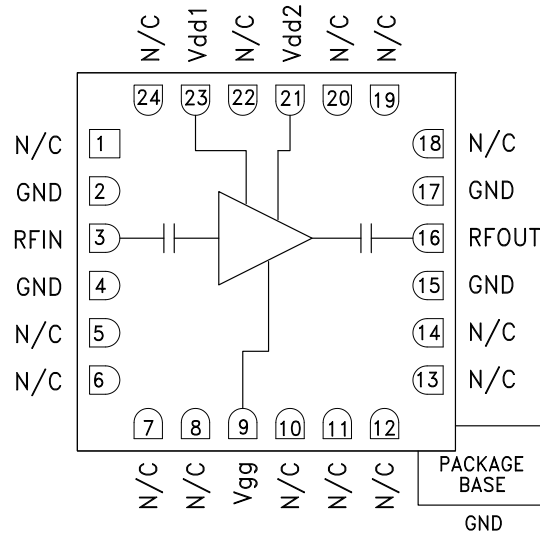

General Description

The HMC609LC4 is a GaAs PHEMT MMIC Low Noise Amplifier (LNA) which operates from 2 to 4 GHz. The HMC609LC4 features extremely flat performance characteristics including 20 dB of small signal gain, 3.5 dB of noise figure and output IP3 of +36.5 dBm across the operating band. This 50 Ohm matched amplifier does not require any external matching components. The HMC609LC4 is compatible with high volume surface mount manufacturing techniques, and the RF I/Os are DC blocked for further ease of integration.

Electrical Specifications, $T_A = +25^\circ\text{C}$, $V_{dd1} = V_{dd2} = +6\text{V}$, $I_{dd1} + I_{dd2} = 170\text{mA}$ [1]

Parameter	Min.	Typ.	Max.	Units
Frequency Range	2 - 4			GHz
Gain	17	20		dB
Gain Variation Over Temperature		0.015	0.02	dB/°C
Noise Figure		3.5	5.5	dB
Input Return Loss		17		dB
Output Return Loss		15		dB
Output Power for 1 dB Compression (P1dB)	18.5	21.5		dBm
Saturated Output Power (P _{sat})		23		dBm
Output Third Order Intercept (IP3)		36.5		dBm
Supply Current (I _{dd1} + I _{dd2})		170	220	mA

Adjust V_{gg} between -1.5V to -0.5V (Typical -0.9V) to achieve total drain bias of 170mA

Information furnished by Analog Devices is believed to be accurate and reliable. However, no responsibility is assumed by Analog Devices for its use, nor for any infringements of patents or other rights of third parties that may result from its use. Specifications subject to change without notice. No license is granted by implication or otherwise under any patent or patent rights of Analog Devices. Trademarks and registered trademarks are the property of their respective owners.

For price, delivery, and to place orders: Analog Devices, Inc., One Technology Way, P.O. Box 9106, Norwood, MA 02062-9106 Phone: 781-329-4700 • Order online at www.analog.com Application Support: Phone: 1-800-ANALOG-D



GaAs PHEMT MMIC LOW NOISE AMPLIFIER, 2 - 4 GHz

Broadband Gain & Return Loss^[1]

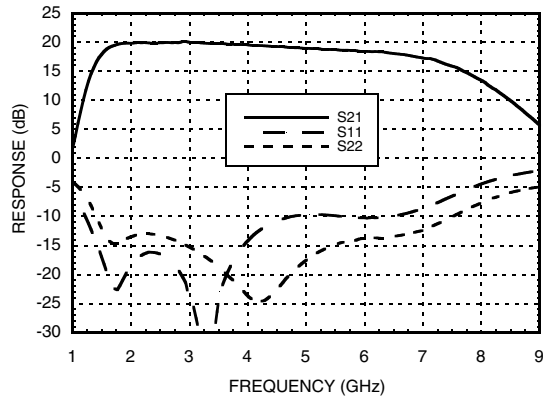

Broadband Gain & Return Loss^[2]

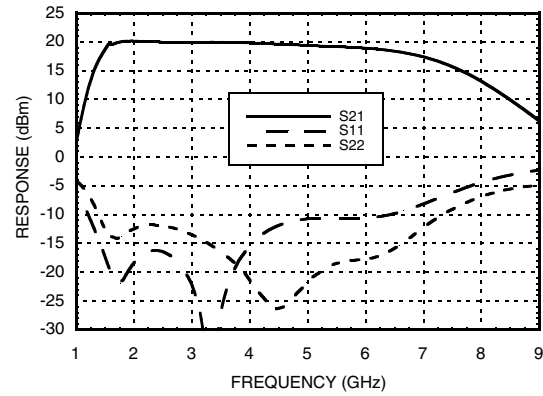

Gain vs. Temperature^[1]

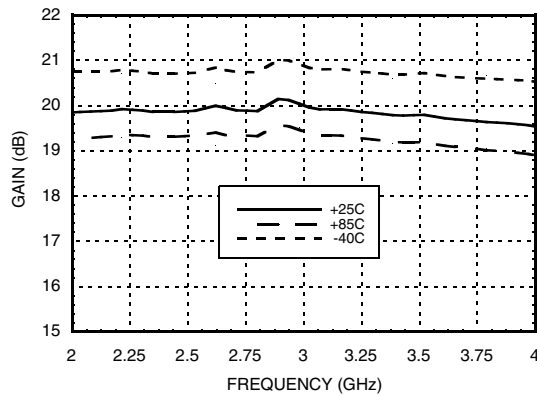

Gain vs. Temperature^[2]

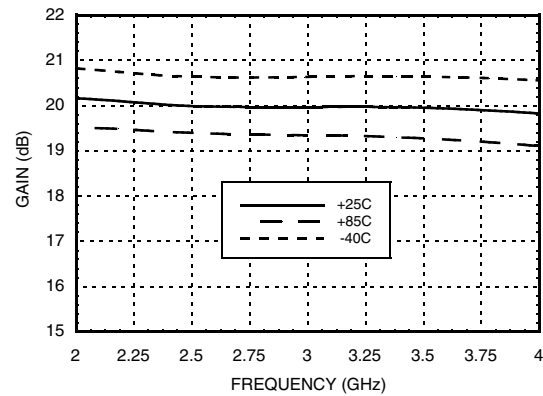

Input Return Loss vs. Temperature^[1]

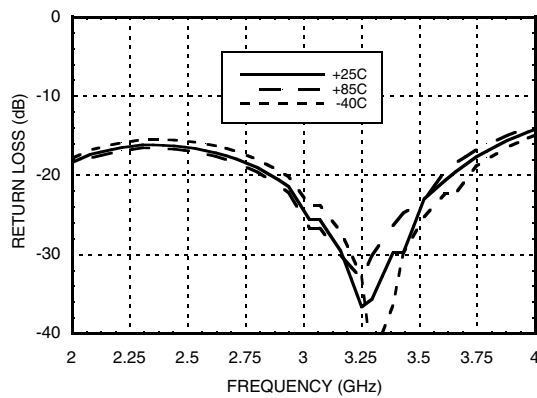

Input Return Loss vs. Temperature^[2]

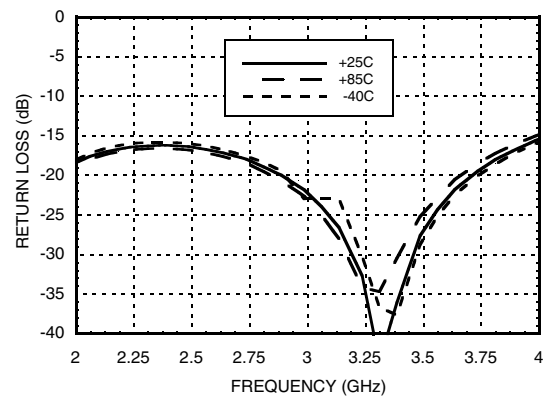

[1] V_{DD} = 6V [2] V_{DD} = 5V

Information furnished by Analog Devices is believed to be accurate and reliable. However, no responsibility is assumed by Analog Devices for its use, nor for any infringements of patents or other rights of third parties that may result from its use. Specifications subject to change without notice. No license is granted by implication or otherwise under any patent or patent rights of Analog Devices. Trademarks and registered trademarks are the property of their respective owners.

For price, delivery, and to place orders: Analog Devices, Inc., One Technology Way, P.O. Box 9106, Norwood, MA 02062-9106 Phone: 781-329-4700 • Order online at www.analog.com Application Support: Phone: 1-800-ANALOG-D



GaAs PHEMT MMIC LOW NOISE AMPLIFIER, 2 - 4 GHz

Output Return Loss vs. Temperature [1]

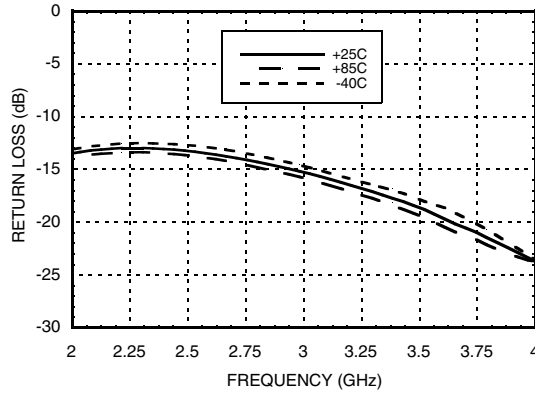

Output Return Loss vs. Temperature [2]

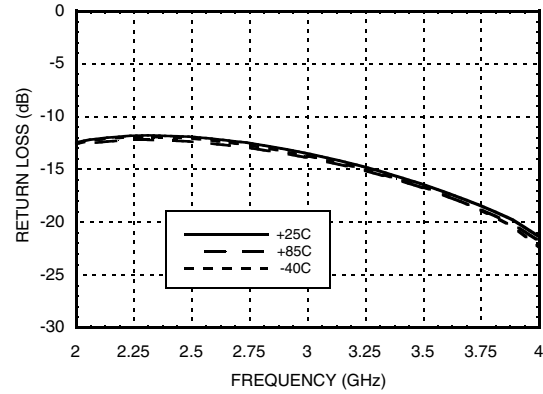

Psat vs. Temperature [1]

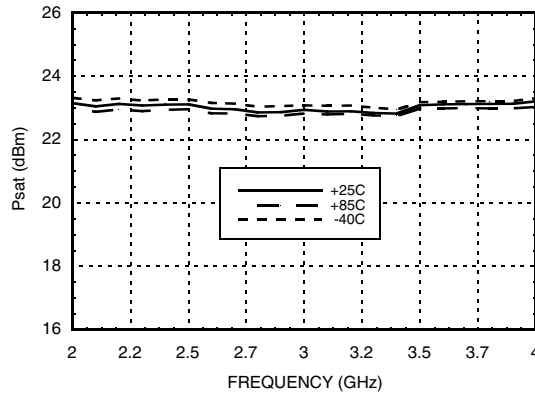

Psat vs. Temperature [2]

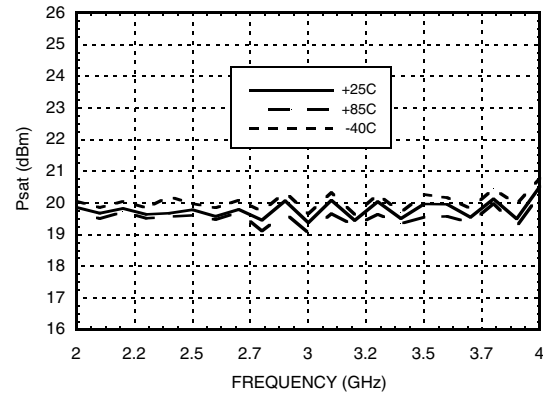

P1dB vs. Temperature [1]

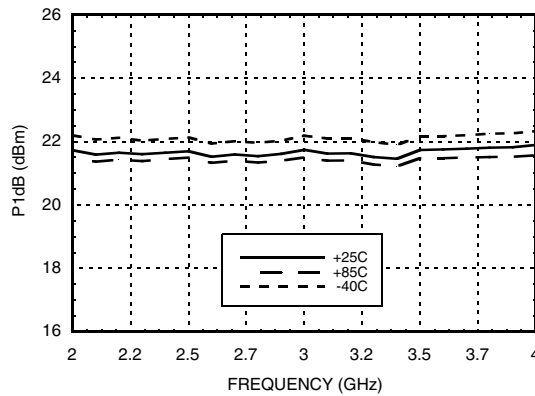

P1dB vs. Temperature [2]

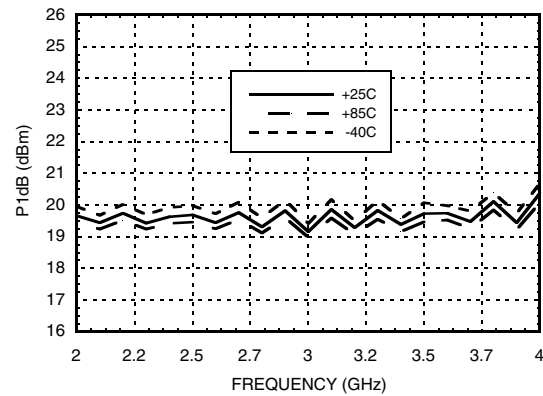

[1] Vdd = 6V

[2] Vdd = 5V

Information furnished by Analog Devices is believed to be accurate and reliable. However, no responsibility is assumed by Analog Devices for its use, nor for any infringements of patents or other rights of third parties that may result from its use. Specifications subject to change without notice. No license is granted by implication or otherwise under any patent or patent rights of Analog Devices. Trademarks and registered trademarks are the property of their respective owners.

For price, delivery, and to place orders: Analog Devices, Inc., One Technology Way, P.O. Box 9106, Norwood, MA 02062-9106 Phone: 781-329-4700 • Order online at www.analog.com Application Support: Phone: 1-800-ANALOG-D



GaAs PHEMT MMIC LOW NOISE AMPLIFIER, 2 - 4 GHz

Output IP3 vs. Temperature [1]

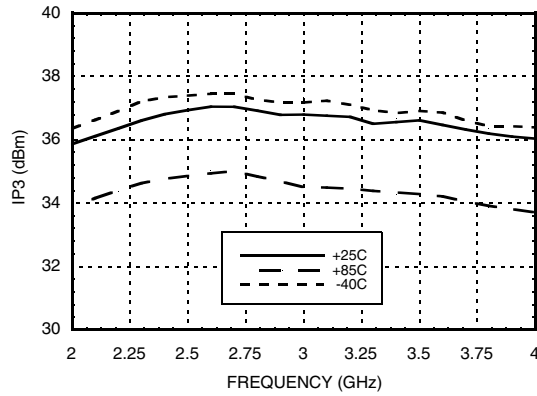

Output IP3 vs. Temperature [2]

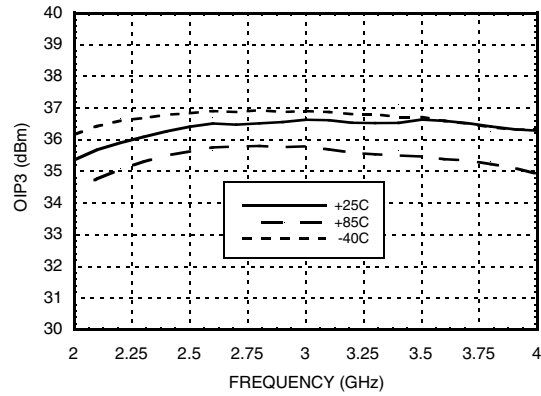

Noise Figure vs. Temperature [1]

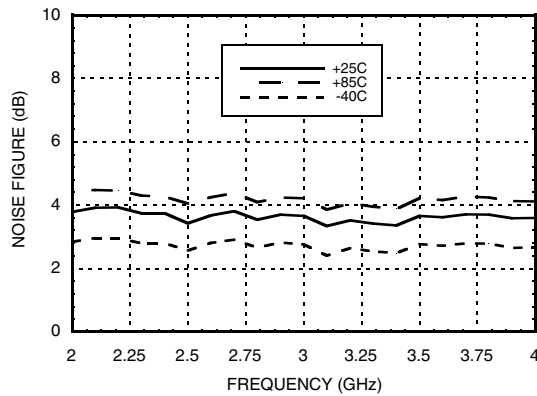

Noise Figure vs. Temperature [2]

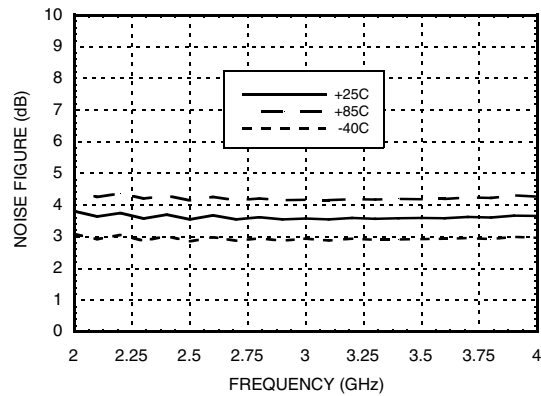

Reverse Isolation vs. Temperature [1]

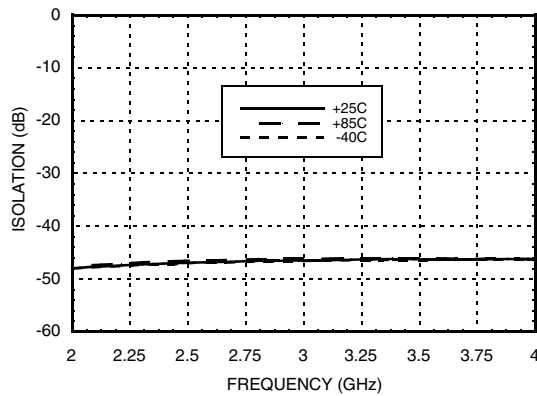

Reverse Isolation vs. Temperature [2]

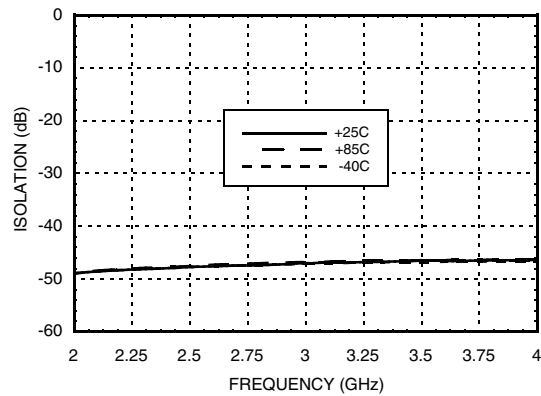

[1] Vdd = 6V

[2] Vdd = 5V

Information furnished by Analog Devices is believed to be accurate and reliable. However, no responsibility is assumed by Analog Devices for its use, nor for any infringements of patents or other rights of third parties that may result from its use. Specifications subject to change without notice. No license is granted by implication or otherwise under any patent or patent rights of Analog Devices. Trademarks and registered trademarks are the property of their respective owners.

For price, delivery, and to place orders: Analog Devices, Inc., One Technology Way, P.O. Box 9106, Norwood, MA 02062-9106 Phone: 781-329-4700 • Order online at www.analog.com Application Support: Phone: 1-800-ANALOG-D

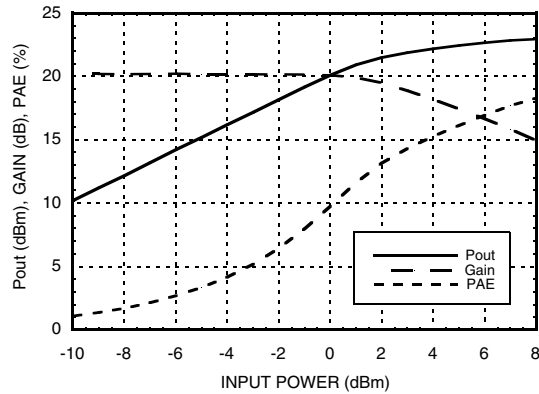
**GaAs PHEMT MMIC LOW NOISE
AMPLIFIER, 2 - 4 GHz**
Power Compression @ 3 GHz

Absolute Maximum Ratings

Drain Bias Voltage (Vdd)	7 Vdc
RF Input Power (RFIN)(Vdd = +6.0 Vdc)	+15 dBm
Channel Temperature	175 °C
Continuous Pdiss (T= 85 °C) (derate 16.7 mW/°C above 85 °C)	1.1 W
Thermal Resistance (channel to ground paddle)	60 °C/W
Storage Temperature	-65 to +150 °C
Operating Temperature	-40 to +85 °C

Typical Supply Current vs. Vdd

Vdd (V)	Idd (mA)
+5.5	160
+6.0	170
+6.5	180

Note: Amplifier will operate over full voltage range shown above



**ELECTROSTATIC SENSITIVE DEVICE
OBSERVE HANDLING PRECAUTIONS**

GaAs PHEMT MMIC LOW NOISE AMPLIFIER, 2 - 4 GHz



Pin Descriptions

Pin Number	Function	Description	Interface Schematic
1, 5 - 8, 10 - 24, 18 - 20, 22, 24	N/C	This pin may be connected to RF/DC ground. Performance will not be affected.	
2, 4, 15, 17	GND	These pins and package bottom must also be connected to RF/DC ground.	
3	RFIN	This pin is AC coupled and matched to 50 Ohms.	
9	Vgg	Gate supply voltage for the amplifier. (External bypass capacitors are required.)	
16	RFOUT	This pin is AC coupled and matched to 50 Ohms.	
21, 23	Vdd1, Vdd2	Power Supply Voltage for the amplifier. (External bypass capacitors are required.).	

Application Circuit

Component	Value
C1 - C3	100 pF
C4 - C6	1,000 pF
C7 - C9	2.2 μF

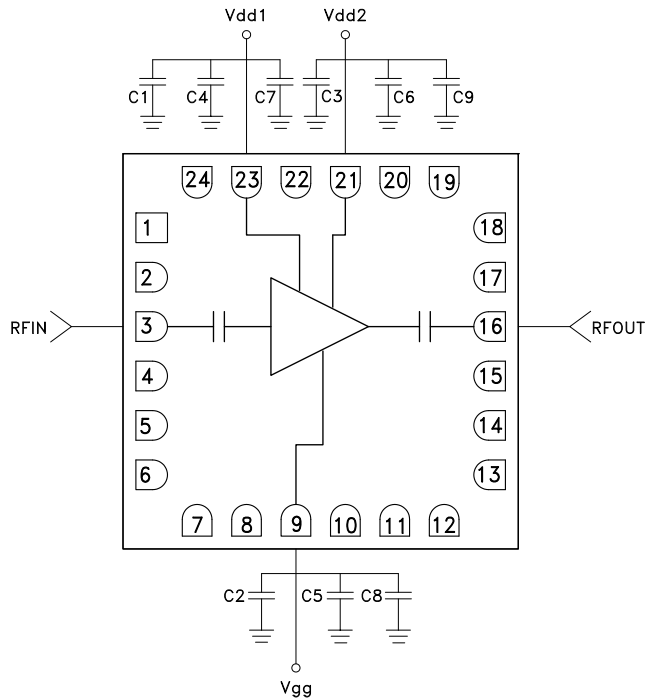

Information furnished by Analog Devices is believed to be accurate and reliable. However, no responsibility is assumed by Analog Devices for its use, nor for any infringements of patents or other rights of third parties that may result from its use. Specifications subject to change without notice. No license is granted by implication or otherwise under any patent or patent rights of Analog Devices. Trademarks and registered trademarks are the property of their respective owners.

For price, delivery, and to place orders: Analog Devices, Inc., One Technology Way, P.O. Box 9106, Norwood, MA 02062-9106 Phone: 781-329-4700 • Order online at www.analog.com Application Support: Phone: 1-800-ANALOG-D



**GaAs PHEMT MMIC LOW NOISE
AMPLIFIER, 2 - 4 GHz**

Evaluation PCB

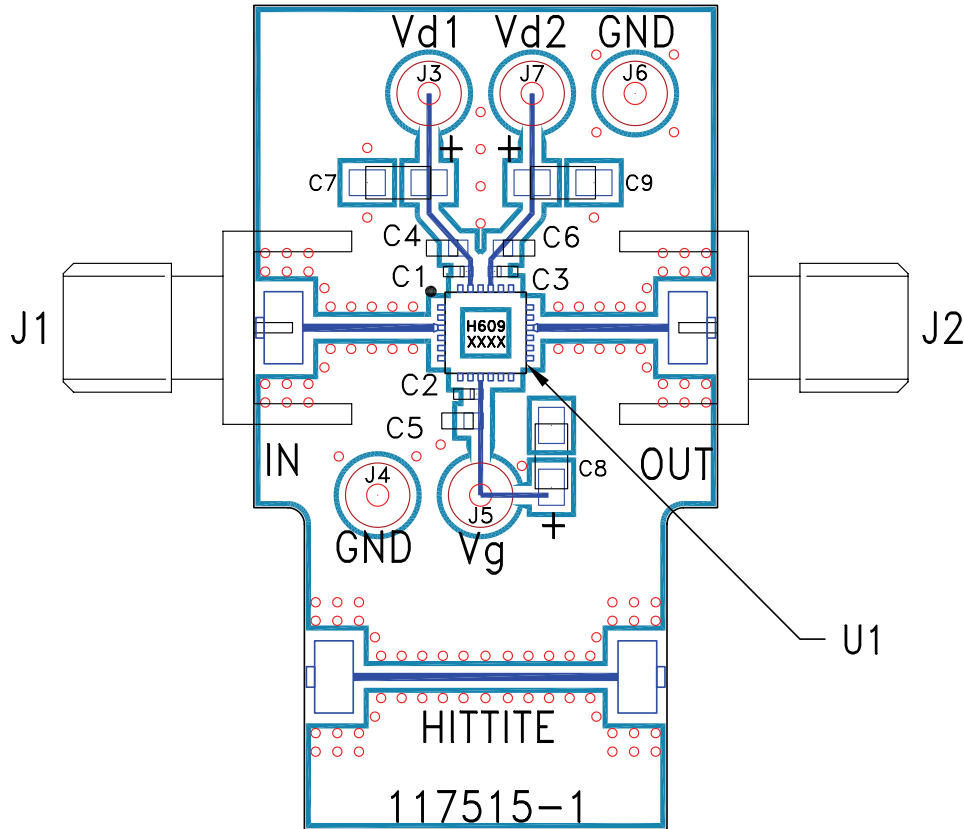

List of Materials for Evaluation PCB 117510 [1]

Item	Description
J1 - J2	PCB Mount SMA Connector
J3 - J7	DC Pin
C1 - C3	100 pF Capacitor, 0402 Pkg.
C4 - C6	1000pF Capacitor, 0603 Pkg.
C7 - C9	2.2 μF Capacitor, Tantalum
U1	HMC609LC4 Amplifier
PCB [2]	1117515 Evaluation PCB

[1] Reference this number when ordering complete evaluation PCB

[2] Circuit Board Material: Rogers 4350

The circuit board used in the application should use RF circuit design techniques. Signal lines should have 50 Ohm impedance while the package ground leads and exposed paddle should be connected directly to the ground plane similar to that shown. A sufficient number of via holes should be used to connect the top and bottom ground planes. The evaluation board should be mounted to an appropriate heat sink. The evaluation circuit board shown is available from Hittite upon request.

Mouser Electronics

Authorized Distributor

Click to View Pricing, Inventory, Delivery & Lifecycle Information:

[Analog Devices Inc.:](#)

[HMC609LC4](#) [HMC609LC4TR](#) [HMC609LC4TR-R5](#)