

EconoPACK™2 module with TRENCHSTOP™ IGBT7 and emitter controlled 7 diode and PressFIT / NTC

Features

- Electrical features
 - $V_{CES} = 1200\text{ V}$
 - $I_{C\text{ nom}} = 150\text{ A} / I_{CRM} = 300\text{ A}$
 - Low $V_{CE,\text{sat}}$
 - Overload operation up to 175°C
 - TRENCHSTOP™ IGBT7
- Mechanical features
 - Integrated NTC temperature sensor
 - High power and thermal cycling capability
 - PressFIT contact technology
 - Al_2O_3 substrate with low thermal resistance
 - Copper base plate



Typical appearance

Potential applications

- Motor drives
- Auxiliary inverters
- Servo drives

Product validation

- Qualified for industrial applications according to the relevant tests of IEC 60747, 60749 and 60068

Description

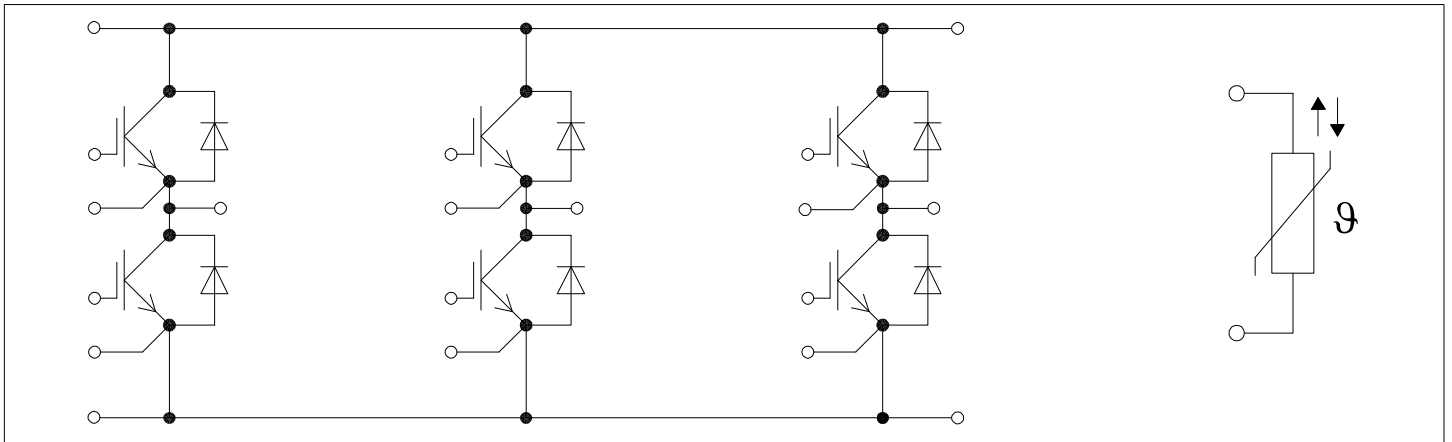

Table of contents

	Description	1
	Features	1
	Potential applications	1
	Product validation	1
	Table of contents	2
1	Package	3
2	IGBT, Inverter	3
3	Diode, Inverter	5
4	NTC-Thermistor	6
5	Characteristics diagrams	7
6	Circuit diagram	12
7	Package outlines	13
8	Module label code	14
	Revision history	15
	Disclaimer	16

1 Package

Table 1 Insulation coordination

Parameter	Symbol	Note or test condition	Values	Unit
Isolation test voltage	V_{ISOL}	RMS, $f = 50 \text{ Hz}$, $t = 1 \text{ min}$	2.5	kV
Material of module baseplate			Cu	
Internal isolation		basic insulation (class 1, IEC 61140)	Al_2O_3	
Creepage distance	d_{Creep}	terminal to heatsink	10.0	mm
Clearance	d_{Clear}	terminal to heatsink	7.5	mm
Comparative tracking index	CTI		>200	
Relative thermal index (electrical)	RTI	housing	140	°C

Table 2 Characteristic values

Parameter	Symbol	Note or test condition	Values			Unit
			Min.	Typ.	Max.	
Stray inductance module	L_{sCE}			26		nH
Module lead resistance, terminals - chip	$R_{CC'+EE'}$	$T_C = 25^\circ\text{C}$, per switch		2.5		mΩ
Storage temperature	T_{stg}		-40		125	°C
Mounting torque for module mounting	M	- Mounting according to valid application note	M5, Screw	3	6	Nm
Weight	G			180		g

Note: The current under continuous operation is limited to 115 A rms in the main AC and DC power terminals and limited to 50 A rms per connector pin.

2 IGBT, Inverter

Table 3 Maximum rated values

Parameter	Symbol	Note or test condition	Values	Unit
Collector-emitter voltage	V_{CES}	$T_{vj} = 25^\circ\text{C}$	1200	V
Continuous DC collector current	I_{CDC}	$T_{vj\max} = 175^\circ\text{C}$ $T_C = 80^\circ\text{C}$	150	A
Repetitive peak collector current	I_{CRM}	$t_P = 1 \text{ ms}$	300	A
Gate-emitter peak voltage	V_{GES}		±20	V

Table 4 Characteristic values

Parameter	Symbol	Note or test condition	Values			Unit	
			Min.	Typ.	Max.		
Collector-emitter saturation voltage	$V_{CE\ sat}$	$I_C = 150\ A, V_{GE} = 15\ V$	$T_{vj} = 25\ ^\circ C$		1.55	1.80	V
			$T_{vj} = 125\ ^\circ C$		1.69		
			$T_{vj} = 175\ ^\circ C$		1.77		
Gate threshold voltage	V_{GEth}	$I_C = 3.5\ mA, V_{CE} = V_{GE}, T_{vj} = 25\ ^\circ C$		5.15	5.80	6.45	V
Gate charge	Q_G	$V_{GE} = \pm 15\ V, V_{CE} = 600\ V$			2.5		μC
Internal gate resistor	R_{Gint}	$T_{vj} = 25\ ^\circ C$			1		Ω
Input capacitance	C_{ies}	$f = 100\ kHz, T_{vj} = 25\ ^\circ C, V_{CE} = 25\ V, V_{GE} = 0\ V$			30.1		nF
Reverse transfer capacitance	C_{res}	$f = 100\ kHz, T_{vj} = 25\ ^\circ C, V_{CE} = 25\ V, V_{GE} = 0\ V$			0.105		nF
Collector-emitter cut-off current	I_{CES}	$V_{CE} = 1200\ V, V_{GE} = 0\ V$	$T_{vj} = 25\ ^\circ C$			0.012	mA
Gate-emitter leakage current	I_{GES}	$V_{CE} = 0\ V, V_{GE} = 20\ V, T_{vj} = 25\ ^\circ C$				100	nA
Turn-on delay time (inductive load)	t_{don}	$I_C = 150\ A, V_{CE} = 600\ V, V_{GE} = \pm 15\ V, R_{Gon} = 3.6\ \Omega$	$T_{vj} = 25\ ^\circ C$		0.170		μs
			$T_{vj} = 125\ ^\circ C$		0.185		
			$T_{vj} = 175\ ^\circ C$		0.197		
Rise time (inductive load)	t_r	$I_C = 150\ A, V_{CE} = 600\ V, V_{GE} = \pm 15\ V, R_{Gon} = 3.6\ \Omega$	$T_{vj} = 25\ ^\circ C$		0.060		μs
			$T_{vj} = 125\ ^\circ C$		0.064		
			$T_{vj} = 175\ ^\circ C$		0.065		
Turn-off delay time (inductive load)	t_{doff}	$I_C = 150\ A, V_{CE} = 600\ V, V_{GE} = \pm 15\ V, R_{Goff} = 3.6\ \Omega$	$T_{vj} = 25\ ^\circ C$		0.331		μs
			$T_{vj} = 125\ ^\circ C$		0.414		
			$T_{vj} = 175\ ^\circ C$		0.456		
Fall time (inductive load)	t_f	$I_C = 150\ A, V_{CE} = 600\ V, V_{GE} = \pm 15\ V, R_{Goff} = 3.6\ \Omega$	$T_{vj} = 25\ ^\circ C$		0.107		μs
			$T_{vj} = 125\ ^\circ C$		0.200		
			$T_{vj} = 175\ ^\circ C$		0.280		
Turn-on energy loss per pulse	E_{on}	$I_C = 150\ A, V_{CE} = 600\ V, L_\sigma = 35\ nH, V_{GE} = \pm 15\ V, R_{Gon} = 3.6\ \Omega, di/dt = 1860\ A/\mu s (T_{vj} = 175\ ^\circ C)$	$T_{vj} = 25\ ^\circ C$		20.5		mJ
			$T_{vj} = 125\ ^\circ C$		26.1		
			$T_{vj} = 175\ ^\circ C$		29.8		
Turn-off energy loss per pulse	E_{off}	$I_C = 150\ A, V_{CE} = 600\ V, L_\sigma = 35\ nH, V_{GE} = \pm 15\ V, R_{Goff} = 3.6\ \Omega, dv/dt = 3160\ V/\mu s (T_{vj} = 175\ ^\circ C)$	$T_{vj} = 25\ ^\circ C$		9.42		mJ
			$T_{vj} = 125\ ^\circ C$		15.5		
			$T_{vj} = 175\ ^\circ C$		19.5		
SC data	I_{SC}	$V_{GE} \leq 15\ V, V_{CC} = 800\ V, V_{CEmax} = V_{CES} - L_{sCE} * di/dt$	$t_p \leq 8\ \mu s, T_{vj} = 150\ ^\circ C$		530		A
			$t_p \leq 7\ \mu s, T_{vj} = 175\ ^\circ C$		500		

(table continues...)

Table 4 (continued) Characteristic values

Parameter	Symbol	Note or test condition	Values			Unit
			Min.	Typ.	Max.	
Thermal resistance, junction to case	R_{thJC}	per IGBT			0.293	K/W
Thermal resistance, case to heat sink	R_{thCH}	per IGBT, $\lambda_{grease} = 1 \text{ W}/(\text{m}^2\text{K})$		0.129		K/W
Temperature under switching conditions	$T_{vj\text{op}}$		-40		175	°C

Note: $T_{vj\text{op}} > 150^\circ\text{C}$ is allowed for operation at overload conditions. For detailed specifications, please refer to AN 2018-14.

3 Diode, Inverter

Table 5 Maximum rated values

Parameter	Symbol	Note or test condition	Values	Unit	
Repetitive peak reverse voltage	V_{RRM}	$T_{vj} = 25^\circ\text{C}$	1200	V	
Continuous DC forward current	I_F		150	A	
Repetitive peak forward current	I_{FRM}	$t_P = 1 \text{ ms}$	300	A	
I^2t - value	I^2t	$t_P = 10 \text{ ms}, V_R = 0 \text{ V}$	$T_{vj} = 125^\circ\text{C}$	2750	A^2s
			$T_{vj} = 175^\circ\text{C}$	2530	

Table 6 Characteristic values

Parameter	Symbol	Note or test condition	Values			Unit	
			Min.	Typ.	Max.		
Forward voltage	V_F	$I_F = 150 \text{ A}, V_{GE} = 0 \text{ V}$	$T_{vj} = 25^\circ\text{C}$		1.72	2.10	V
			$T_{vj} = 125^\circ\text{C}$		1.59		
			$T_{vj} = 175^\circ\text{C}$		1.52		
Peak reverse recovery current	I_{RM}	$V_R = 600 \text{ V}, I_F = 150 \text{ A}, V_{GE} = -15 \text{ V}, -di_F/dt = 1860 \text{ A}/\mu\text{s} (T_{vj} = 175^\circ\text{C})$	$T_{vj} = 25^\circ\text{C}$		66.8		A
			$T_{vj} = 125^\circ\text{C}$		93		
			$T_{vj} = 175^\circ\text{C}$		109		
Recovered charge	Q_r	$V_R = 600 \text{ V}, I_F = 150 \text{ A}, V_{GE} = -15 \text{ V}, -di_F/dt = 1860 \text{ A}/\mu\text{s} (T_{vj} = 175^\circ\text{C})$	$T_{vj} = 25^\circ\text{C}$		10		μC
			$T_{vj} = 125^\circ\text{C}$		20.6		
			$T_{vj} = 175^\circ\text{C}$		27.7		

(table continues...)

Table 6 (continued) Characteristic values

Parameter	Symbol	Note or test condition	Values			Unit
			Min.	Typ.	Max.	
Reverse recovery energy	E_{rec}	$V_R = 600\text{ V}$, $I_F = 150\text{ A}$, $V_{GE} = -15\text{ V}$, $-di_F/dt = 1860\text{ A}/\mu\text{s}$ ($T_{vj} = 175\text{ °C}$)	$T_{vj} = 25\text{ °C}$	2.72		mJ
			$T_{vj} = 125\text{ °C}$	6.2		
			$T_{vj} = 175\text{ °C}$	8.61		
Thermal resistance, junction to case	R_{thJC}	per diode			0.454	K/W
Thermal resistance, case to heat sink	R_{thCH}	per diode, $\lambda_{grease} = 1\text{ W}/(\text{m}\cdot\text{K})$		0.140		K/W
Temperature under switching conditions	$T_{vj\text{ op}}$		-40		175	°C

Note: $T_{vj\text{ op}} > 150\text{ °C}$ is allowed for operation at overload conditions. For detailed specifications, please refer to AN 2018-14.

4 NTC-Thermistor

Table 7 Characteristic values

Parameter	Symbol	Note or test condition	Values			Unit
			Min.	Typ.	Max.	
Rated resistance	R_{25}	$T_{NTC} = 25\text{ °C}$		5		kΩ
Deviation of R_{100}	$\Delta R/R$	$T_{NTC} = 100\text{ °C}$, $R_{100} = 493\ \Omega$	-5		5	%
Power dissipation	P_{25}	$T_{NTC} = 25\text{ °C}$			20	mW
B-value	$B_{25/50}$	$R_2 = R_{25} \exp[B_{25/50}(1/T_2 - 1/(298,15\text{ K}))]$		3375		K
B-value	$B_{25/80}$	$R_2 = R_{25} \exp[B_{25/80}(1/T_2 - 1/(298,15\text{ K}))]$		3411		K
B-value	$B_{25/100}$	$R_2 = R_{25} \exp[B_{25/100}(1/T_2 - 1/(298,15\text{ K}))]$		3433		K

Note: Specification according to the valid application note.

5 Characteristics diagrams

Output characteristic (typical), IGBT, Inverter

$I_C = f(V_{CE})$
 $V_{GE} = 15 \text{ V}$

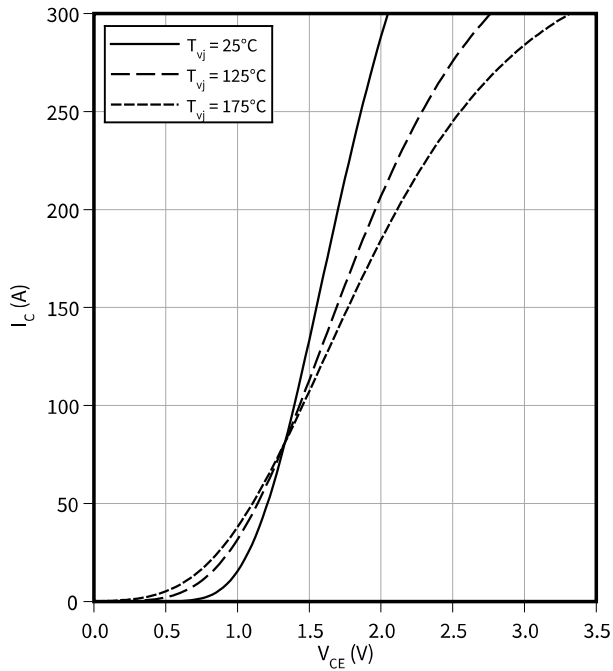

Output characteristic field (typical), IGBT, Inverter

$I_C = f(V_{CE})$
 $T_{vj} = 175 \text{ °C}$

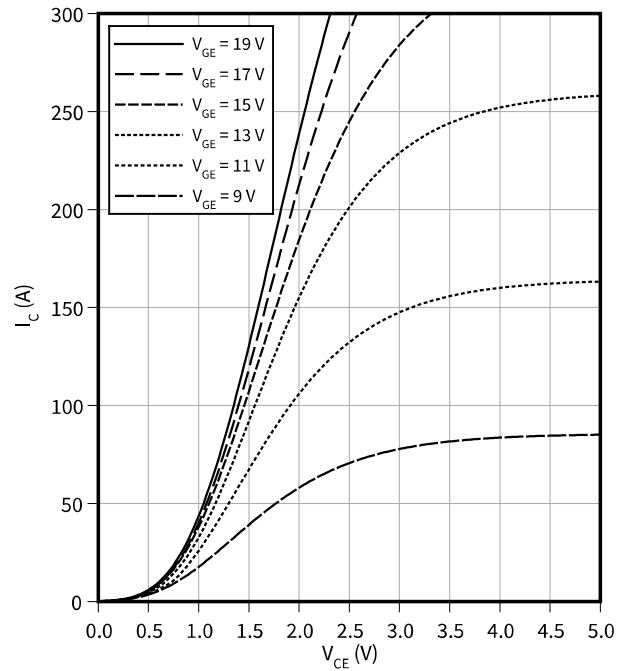

Transfer characteristic (typical), IGBT, Inverter

$I_C = f(V_{GE})$
 $V_{CE} = 20 \text{ V}$

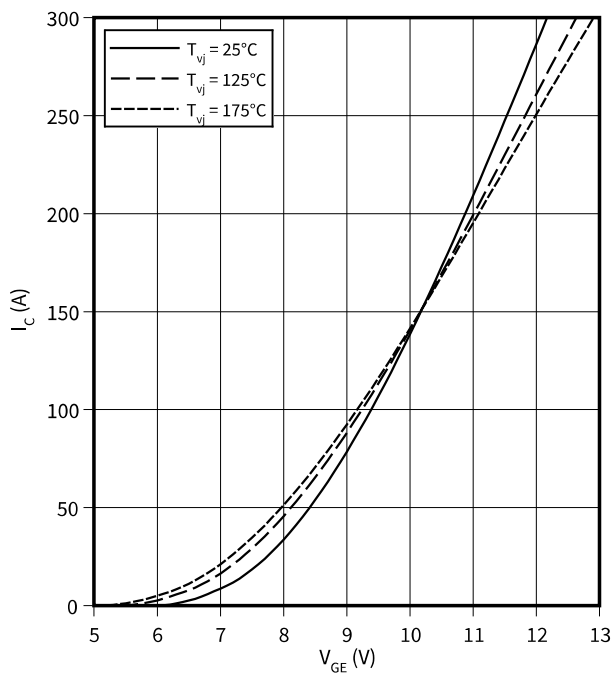

Switching losses (typical), IGBT, Inverter

$E = f(I_C)$
 $R_{Goff} = 3.6 \text{ } \Omega$, $R_{Gon} = 3.6 \text{ } \Omega$, $V_{GE} = \pm 15 \text{ V}$, $V_{CE} = 600 \text{ V}$

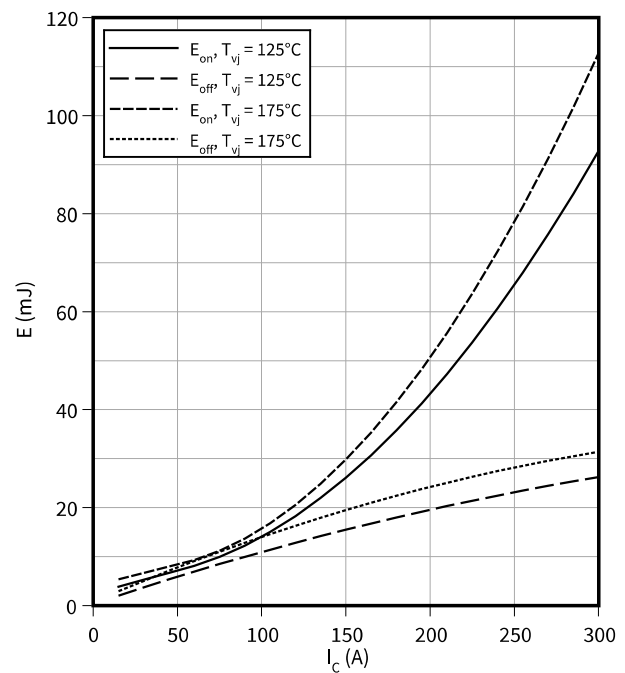

5 Characteristics diagrams

Switching losses (typical), IGBT, Inverter

$E = f(R_G)$

$V_{GE} = \pm 15 \text{ V}$, $I_C = 150 \text{ A}$, $V_{CE} = 600 \text{ V}$

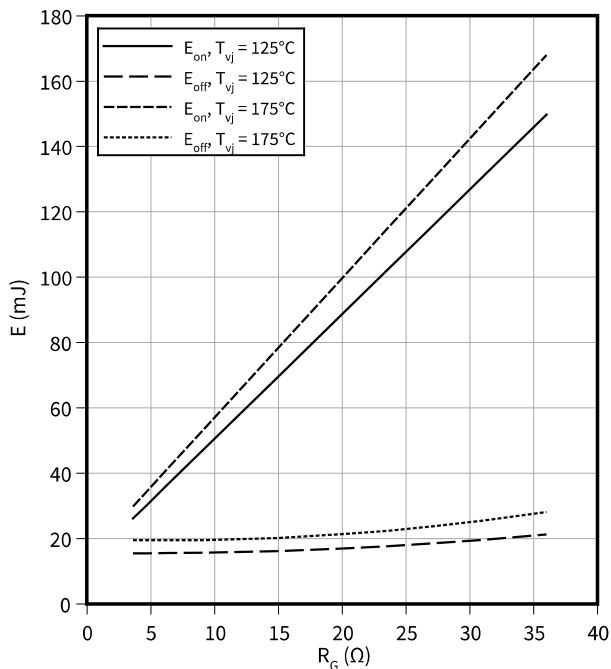

Switching times (typical), IGBT, Inverter

$t = f(I_C)$

$R_{Goff} = 3.6 \Omega$, $R_{Gon} = 3.6 \Omega$, $V_{GE} = \pm 15 \text{ V}$, $V_{CE} = 600 \text{ V}$, $T_{vj} = 175 \text{ °C}$

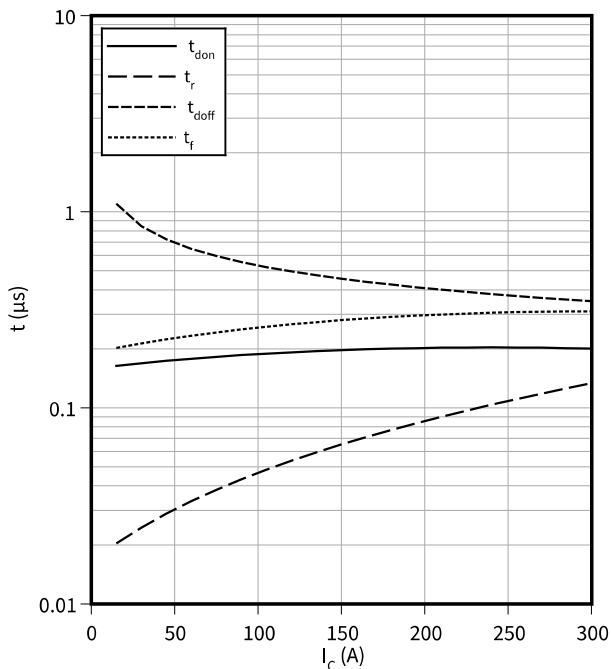

Switching times (typical), IGBT, Inverter

$t = f(R_G)$

$V_{GE} = \pm 15 \text{ V}$, $I_C = 150 \text{ A}$, $V_{CE} = 600 \text{ V}$, $T_{vj} = 175 \text{ °C}$

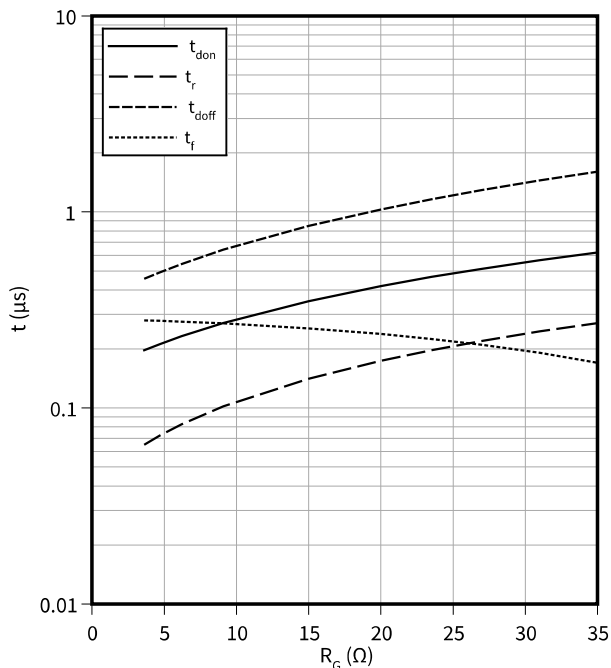

Transient thermal impedance, IGBT, Inverter

$Z_{th} = f(t)$

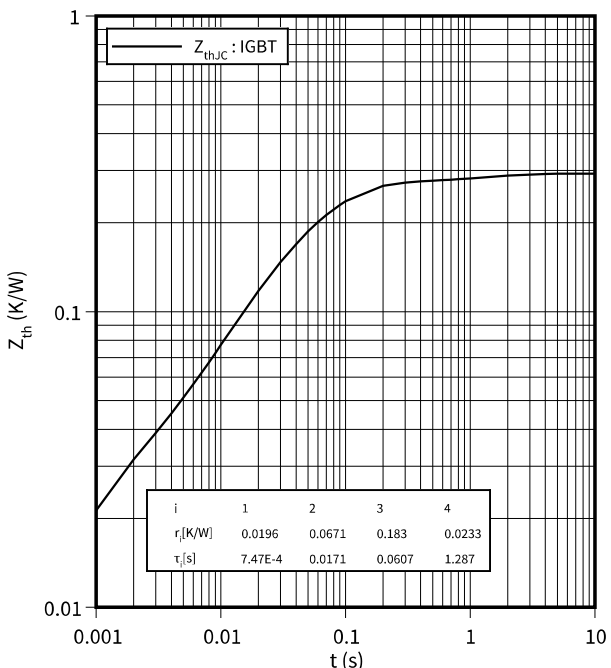

5 Characteristics diagrams

Voltage slope (typical), IGBT, Inverter

$dv/dt = f(R_G)$

$I_C = 150\text{ A}$, $V_{CE} = 600\text{ V}$, $V_{GE} = \pm 15\text{ V}$, $T_{vj} = 25\text{ }^\circ\text{C}$

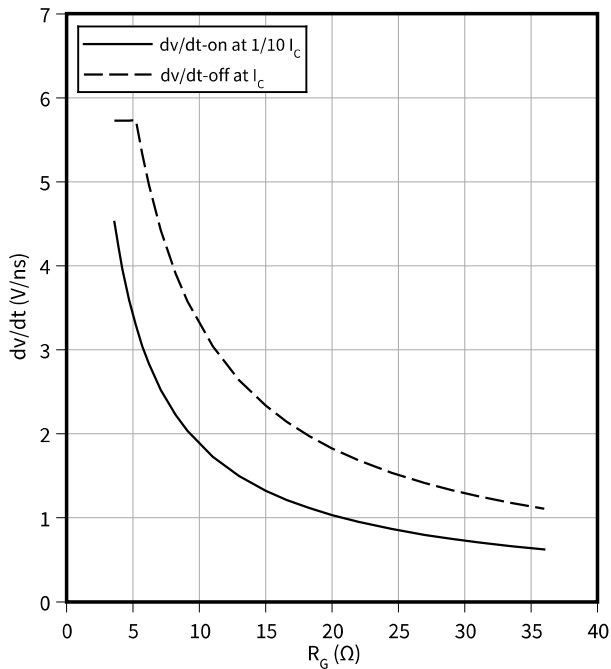

Reverse bias safe operating area (RBSOA), IGBT, Inverter

$I_C = f(V_{CE})$

$R_{Goff} = 3.6\text{ } \Omega$, $V_{GE} = \pm 15\text{ V}$, $T_{vj} = 175\text{ }^\circ\text{C}$

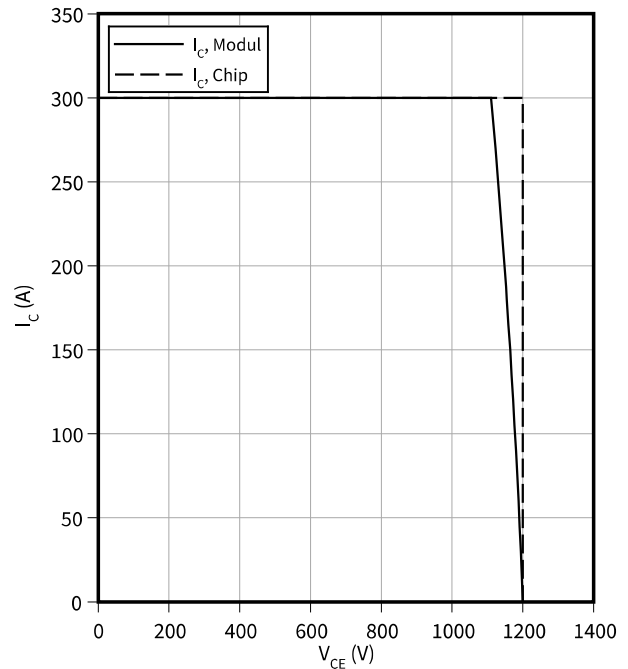

Capacity characteristic (typical), IGBT, Inverter

$C = f(V_{CE})$

$f = 100\text{ kHz}$, $V_{GE} = 0\text{ V}$, $T_{vj} = 25\text{ }^\circ\text{C}$

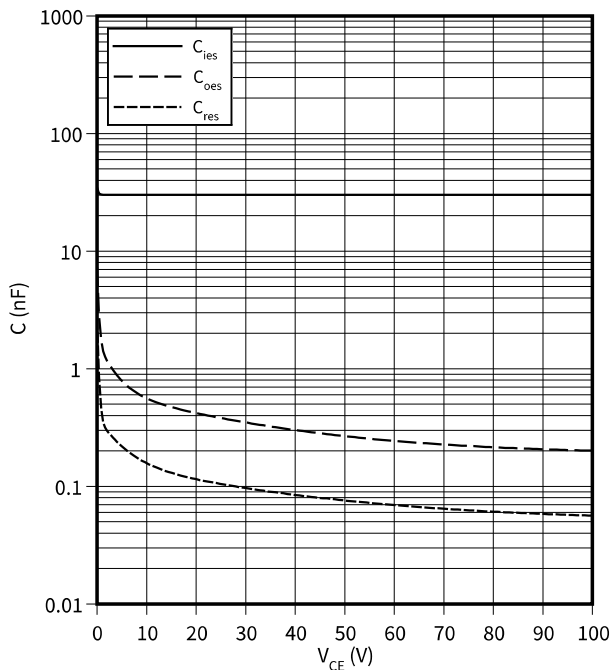

Gate charge characteristic (typical), IGBT, Inverter

$V_{GE} = f(Q_G)$

$I_C = 150\text{ A}$, $T_{vj} = 25\text{ }^\circ\text{C}$

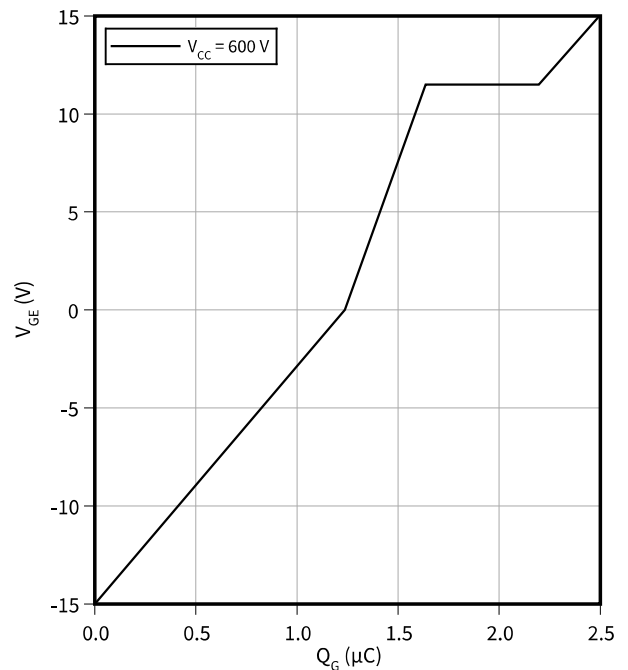

Forward characteristic (typical), Diode, Inverter

$I_F = f(V_F)$

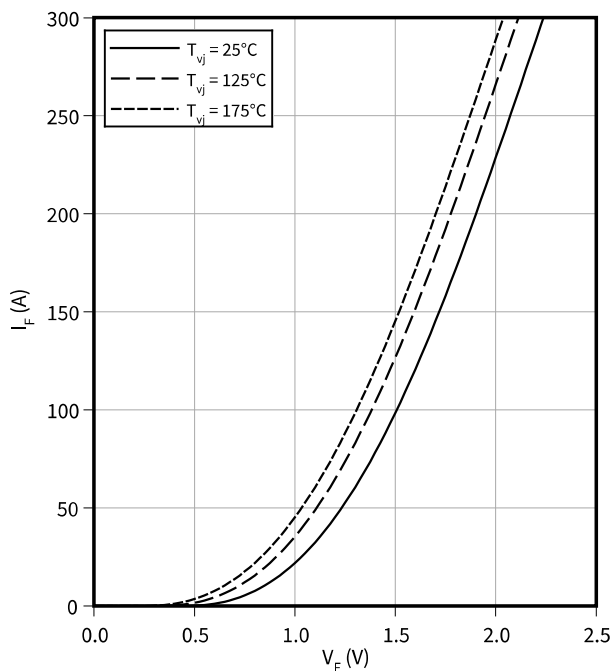

Switching losses (typical), Diode, Inverter

$E_{rec} = f(I_F)$

$R_{Gon} = 3.6 \Omega, V_R = 600 \text{ V}$

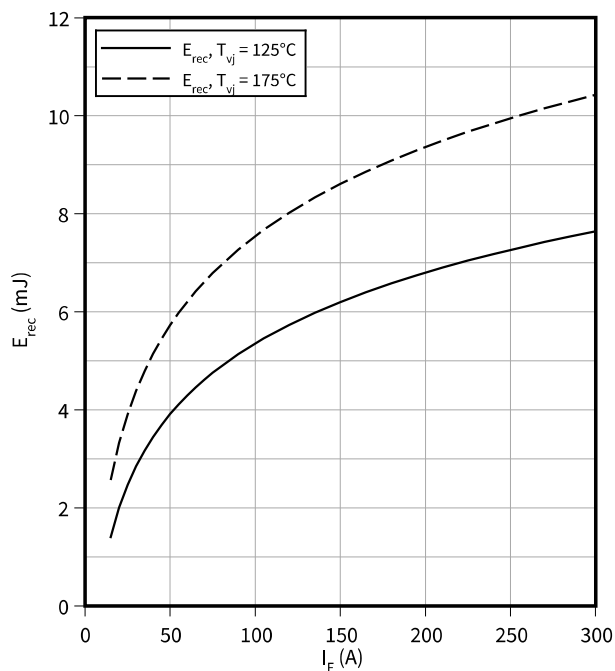

Switching losses (typical), Diode, Inverter

$E_{rec} = f(R_G)$

$I_F = 150 \text{ A}, V_R = 600 \text{ V}$

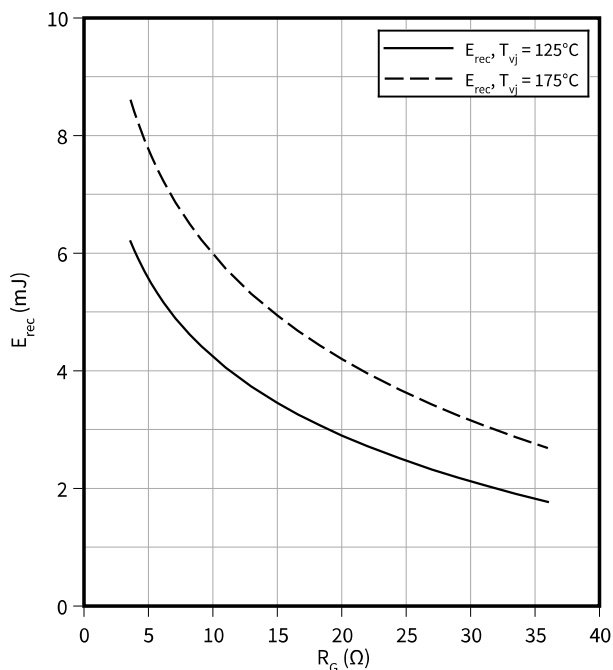

Transient thermal impedance, Diode, Inverter

$Z_{th} = f(t)$

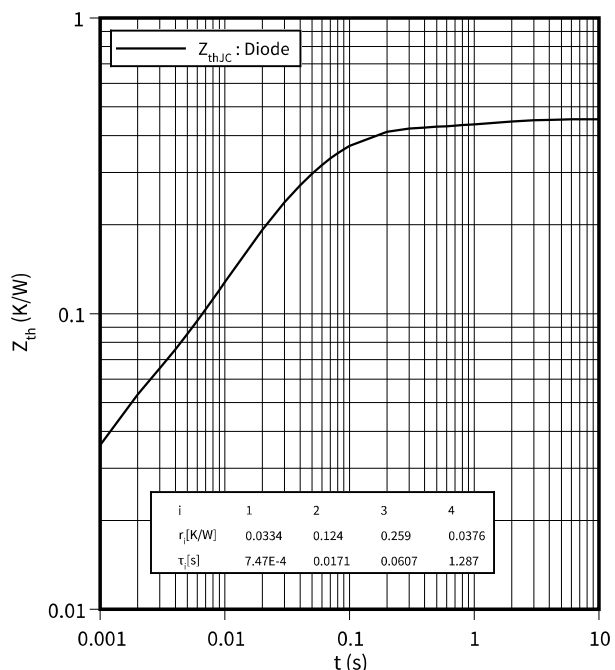

Temperature characteristic (typical), NTC-Thermistor

$R = f(T_{NTC})$

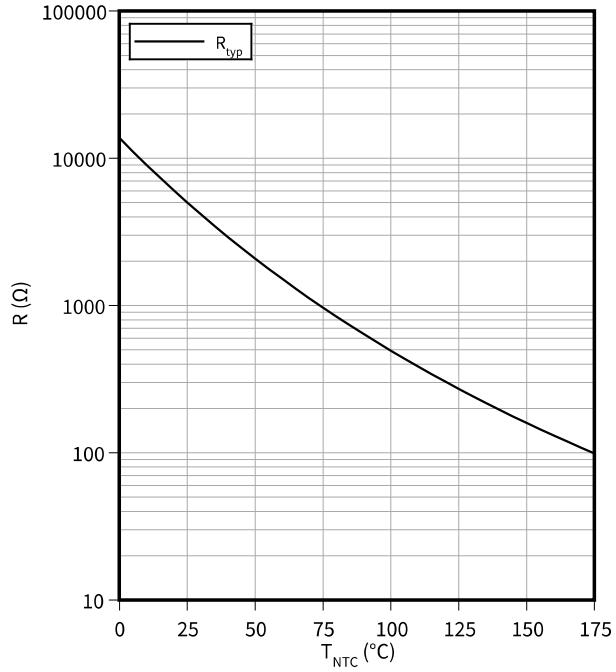

6 Circuit diagram

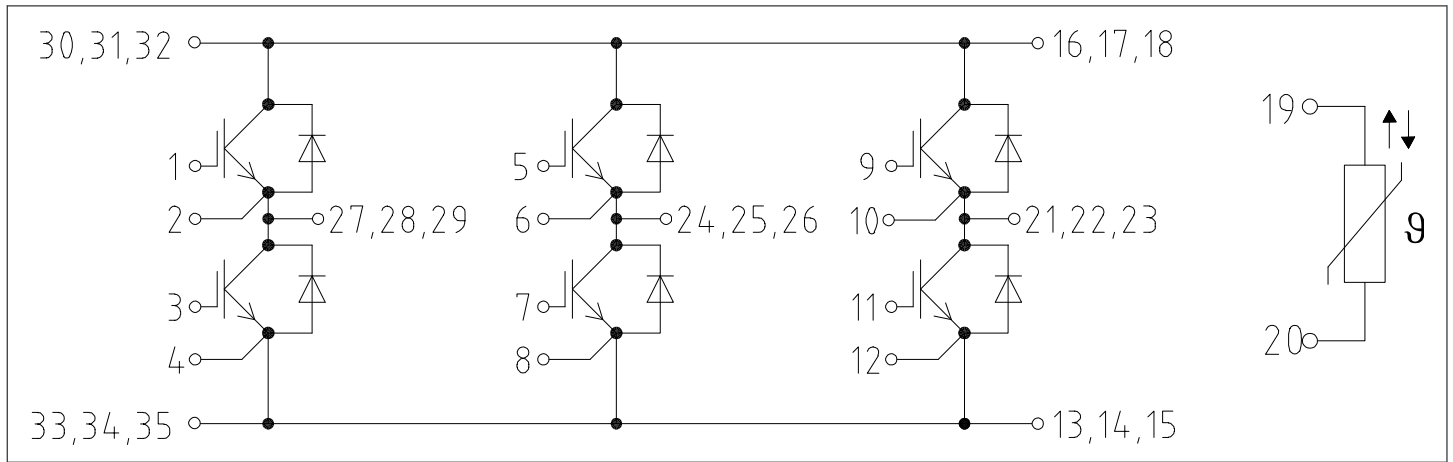

Figure 1

7 Package outlines

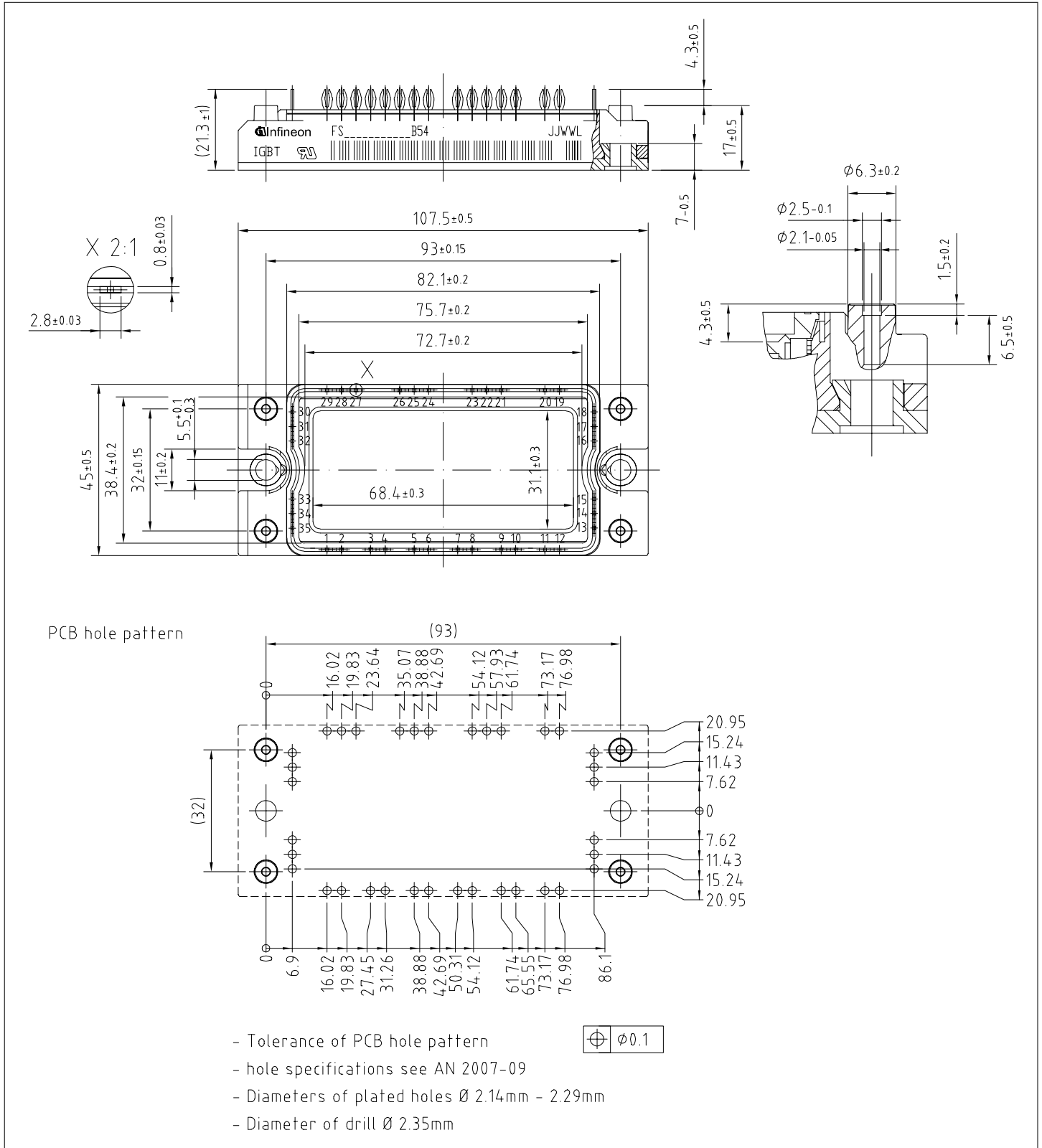

Figure 2

8 Module label code



Module label code			
Code format	Data Matrix	Barcode Code128	
Encoding	ASCII text	Code Set A	
Symbol size	16x16	23 digits	
Standard	IEC24720 and IEC16022	IEC8859-1	
Code content	<i>Content</i>	<i>Digit</i>	<i>Example</i>
	Module serial number	1 - 5	71549
	Module material number	6 - 11	142846
	Production order number	12 - 19	55054991
	Date code (production year)	20 - 21	15
	Date code (production week)	22 - 23	30
Example	 		
	71549142846550549911530		71549142846550549911530

Figure 3

Revision history

Revision history

Document revision	Date of release	Description of changes
1.00	2022-01-13	Initial version

Trademarks

All referenced product or service names and trademarks are the property of their respective owners.

Edition 2022-01-13

**Published by
Infineon Technologies AG
81726 Munich, Germany**

**© 2022 Infineon Technologies AG
All Rights Reserved.**

**Do you have a question about any
aspect of this document?**

Email: erratum@infineon.com

**Document reference
IFX-AYY214-002**

IMPORTANT NOTICE

The information given in this document shall in no event be regarded as a guarantee of conditions or characteristics ("Beschaffheitsgarantie").

With respect to any examples, hints or any typical values stated herein and/or any information regarding the application of the product, Infineon Technologies hereby disclaims any and all warranties and liabilities of any kind, including without limitation warranties of non-infringement of intellectual property rights of any third party.

In addition, any information given in this document is subject to customer's compliance with its obligations stated in this document and any applicable legal requirements, norms and standards concerning customer's products and any use of the product of Infineon Technologies in customer's applications.

The data contained in this document is exclusively intended for technically trained staff. It is the responsibility of customer's technical departments to evaluate the suitability of the product for the intended

Please note that this product is not qualified according to the AEC Q100 or AEC Q101 documents of the Automotive Electronics Council.

WARNINGS

Due to technical requirements products may contain dangerous substances. For information on the types in question please contact your nearest Infineon Technologies office.

Except as otherwise explicitly approved by Infineon Technologies in a written document signed by authorized representatives of Infineon Technologies, Infineon Technologies' products may not be used in any applications where a failure of the product or any consequences of the use thereof can reasonably be expected to result in personal injury.